

PATLITE U.S.A.

New Frontiers in Safety, Security and Comfort

- ◆ Signal & Cube Towers
- ◆ Rotating Warning Lights
- ◆ Voice Synthesizers
- ◆ Signal Horns
- ◆ Melody, Chime & Alarm Sounds



PATLITE

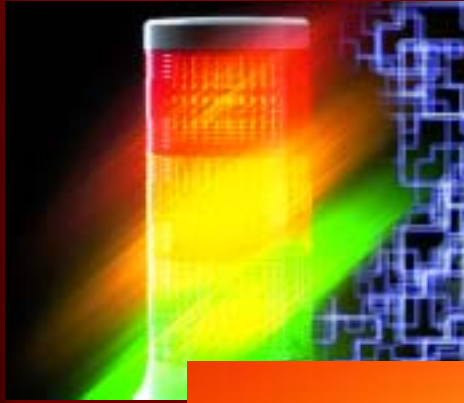

Total Information Technology

For many years Patlite has produced revolving warning lights and a variety of other dependable signal tower lights designed to enhance safety. Throughout our history we have contributed to people's security. Society is now faced with an ever growing volume of increasingly complex data whose management will require more advanced information systems.

We are moving from simple signals to comprehensive systems, from safety and security to information and communication. Patlite is contributing to a safer, more affluent society through the application of comprehensive and reliable information technology.

Product Capability Summary

Explanation of Codes and Symbols Used in this Catalog

IP (Index of Ingress Protection, defined by CEI/IEC 529)

Code No.
IP-

("F" following Code No.: Protection against oil.)

Protection against solid objects			Protection against liquids
No protection.	0	0	No protection.
Protection against solid objects larger than \varnothing 50mm.	1	1	Protection against vertical falling drops of water.
Protection against solid objects larger than \varnothing 12mm.	2	2	Protection against dripping water when tilted up to 15°.
Protection against solid objects larger than \varnothing 2.5mm.	3	3	Protection against spraying water.
Protection against solid objects larger than \varnothing 1mm.	4	4	Protection against splashing water.
Protection against dust-limited ingress (dust-protected.)	5	5	Protection against water jets.
Total protection against dust (dust-tight.)	6	6	Protection against heavy seas.
		7	Protection against the effects of immersion.
		8	Protection against submersion.

Electronic Sound

Buzzer Sound: Easy to recognize but gentle on the ears.

AC Motor

Long-lasting brushless motor provides stable rotation.

Melody

Familiar and easily recognized.

Xenon

Use of Xenon bulb provides high visibility and minimizes bulb burn-out.

Dust-Proof

Highly sealed design that keeps dust and dirt out.

Open Collector

Open-collector compatible allows direct connection to a contactless PLC.

LED

Use of high-luminance LED makes bulb changes unnecessary.

Drip-Proof

Well-sealed housing keeps rain or other water out. Suitable for outdoor use.

Voice Synthesizer

Message conveyed audibly. Select a message from the message library.

Ø 40 Round

Indicates the size and shape of signal lights or revolving lights.

Alarm















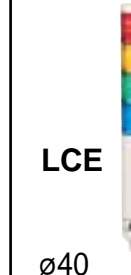

Easy to hear but gentle on the ears.

Water Proof

Provides a level of protection up to and including direct water jets.

Table of Contents









Visual Lighting Products

 CLE ø71 Page: 7	 DeviceNet™ Page: 8	 PHE Page: 9	 ME / MES ø25 Page: 10	 LCE ø40 Page: 11	 LES ø50 Page: 12	 LE / LEL ø50 Page: 13	 SE ø57 Page: 14
 LU7 ø70 Page: 16	 LGE ø100 Page: 17	 WEP / WE 37.5 Profile Page: 18	 WM / WME-A 80 Profile Page: 19	 HSST ø50 Page: 20	 WSL ø50 Page: 20	 XP ø162 Page: 21	 KX ø100 Page: 21

Bacons / Cubes

 RU ø82 Page: 25	 PS ø82 Page: 25	 PEW / PES ø82 Page: 26	 RH-A / RHB-A ø100 Page: 27	 WH-A / WHB-A / WK-A / WKB-A ø100 Page: 27	 SKH-EA ø100 Page: 28	 SKH-A / SKHB-A ø118 Page: 28	 KP ø162 Page: 26
---	---	--	--	---	--	--	--

Audible Alarms

 BT Page: 33	 PV Page: 34-35	 EVB Page: 36	 EVW Page: 37	 PVW Page: 38	 EW / EWS Page: 39	 EB-K, EB-L, EMB, ESB, ETB Page: 40	 BM Page: 41
--	---	---	---	---	--	---	--

PATLITE

Dedicated to the design and development of visual and audible signaling technology, PATLITE offers the industry's most comprehensive selection of signal towers, cube towers, rotating warning lights, voice synthesizers and audible alarms used to indicate machine status!



LME / LME-Q
ø60
Page: 15

**Towers:
Wiring
Diagrams
and
Dimensions**
Page: 22-23

How to Order (Example)

LME - 1 02 FB W - RYGB C

Model	Light Style: 1: 1 Light 2: 2 Light 3: 3 Light 4: 4 Light 5: 5 Light	FB: Flashing & Buzzer	W: Direct Mount	Color: R: Red Y: Yellow G: Green B: Blue C: Clear (Top to Bottom)
Rated Voltage: 01: 12V DC 02: 24V (AC/DC) 12: 120V AC 23: 230-240V AC				



KUS
ø70

Page: 29



KJS/KJSB
ø82

Page: 30



KJ/KJB
ø116

Page: 30

**Beacons
& Cubes:
Wiring
Diagrams**
Page: 31

See PATLITE's Latest Products at

www.patlite.com

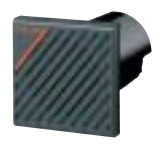

BA/BC

Page: 41



RT

Page: 42



LGEH

Page: 43



KJT

Page: 44

**Audibles:
Sound
List
Selection
Charts**
Page: 45

**Optional
Parts**
Page: 46-47

Signal Towers

Signal Lights • Wall Mounts

Signal Towers

MODEL	PAGE
CLE	7
DeviceNet™ / As-i	8
PHE	9
ME	10
LCE	11
LES	12
LE	13
SE	14
LME	15
LME-Q	15
LU7	16
LGE	17
WE	18
WM	19
HSST	20
WSL	20
XP	21
KX	21
Wiring Diagrams	22
Dimensions	23



PATLITE CLE



The CLE Series Machine Vision Light— uses LEDs for illumination.

LED Type Light

Machine Vision Light

CLE-24 Standard Light

CLE-24N Narrow Light

Specifications

MODEL	CLE-24	CLE-24N
Spot Size	Wide Spot	Narrow Spot
Rated Voltage	24V DC(Either Polarity)	24V DC(Either Polarity)
Power Consumption	3W	3W
Light Source	24 LEDs, White, High Luminosity	
Luminous Intensity @ Optical Center	20 Candela	130 Candela
Installation	Any Direction	Any Direction
Operating Temp. Range	-24°C to +60°C (No Condensation)	
Protection Rating	IP65f	IP65f
Vibration	19.6 m/sec ² (2G)	19.6 m/sec ² (2G)
Mass	0.3 kg	0.3 kg
Glass Surface	Frosted	Clear
Recommended Fuse	1A, 125V	1A, 125V



CLE-24



CLE-24N

ø71mm

- Designed for the machine tool, process, inspection, and image processing industries.
- Superior brightness with high intensity LEDs.
- Low power consumption, low noise, and low heat.
- Anodized aluminum body that is rust, corrosion & oil-proof.
- Lens made of reinforced shock resistant glass for lasting lens transparency.
- Lens glass is frosted for CLE-24, and is clear for CLE-24N.
- Long life and high reliability even in harsh environments.
- Meets IP-65f.

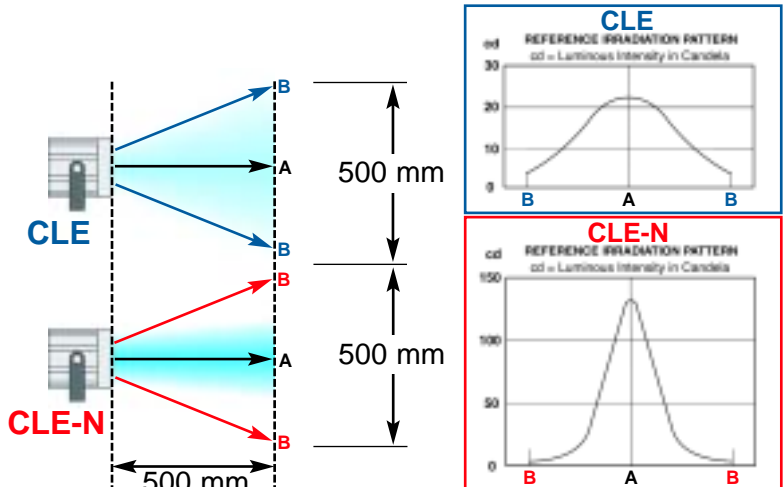
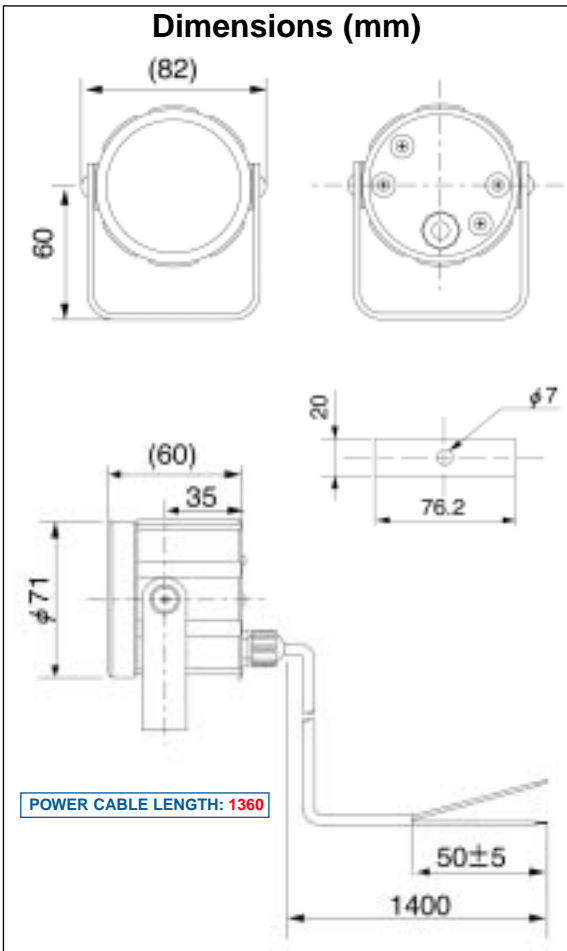

DeviceNet™ Net™

3 Signal Towers

LE-D3 / LE-E3 50mm Diameter

WEP-D3 / WEP-E3 37.5mm Profile

LHE-D3 / LHE-E3 70mm Diameter

DeviceNet™ Type:

Style	Series	Mounting	W/O Alarm	W/Alarm
3 Lights	LE	Direct	LE-D3W	LE-D3BW
	LE	Pole	LE-D3P	LE-D3BP
	LHE	Direct	LHE-D3	LHE-D3B
	WEP	Wall	WEP-D3	WEP-D3B

Other configurations available.

LED
Type
Lights

As-i Type:

Style	Series	Mounting	W/O Alarm	W/Alarm	Power Supply
3 Lights	LE	Direct	LE-E3W	LE-E3BW	Auxiliary
	LE	Pole	LE-E3P	LE-E3BP	Auxiliary
	LHE	Direct	LHE-E3	LHE-E3B	Auxiliary
	WEP	Wall	WEP-E3	WEP-E3B	Auxiliary

Other configurations available.

3 Signal Towers available with DeviceNet™ or As-i

If your control bus is a DeviceNet™ or As-i system, Patlite has three signal tower choices for you. This low cost industrial network solution is rapidly growing in popularity.

DeviceNet™ or As-i can give you the connectivity to eliminate expensive wiring while providing device-level diagnostics and control. Our DeviceNet™ and As-i series will improve machine/operator communication and increase production. These high quality LED status indicators feature bright and long lasting LEDs, as well as a modern, aesthetic design. All models have an audible alarm option. LE and LHE have pole mount capability.

"Versatile"

LE-D3
LE-E3



ø50mm

"Wall Mount"

WEP-D3
WEP-E3



37.5mm
profile

"Wide Body"

LHE-D3
LHE-E3



ø70mm

Dimensions (mm)

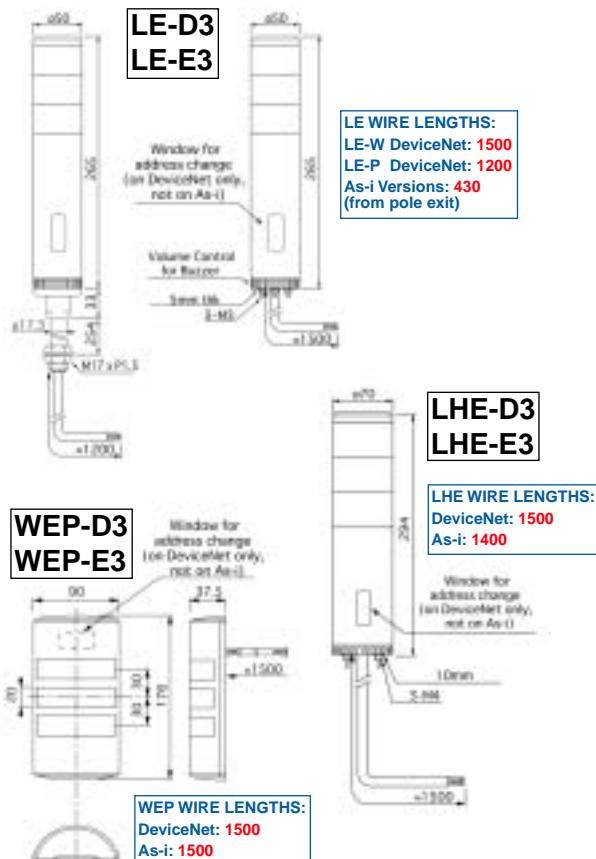

- Long lasting LEDs.
- 50mm diameter.
- LED modules are interchangeable and stackable after purchase.
- Optional buzzer.
- Colors: red, yellow, blue, green & clear.
- IP-23 rated.

- Mountable on wall or ceiling.
- Unique 37.5mm profile.
- Super bright LEDs.
- Optional buzzer.
- Colors: red, yellow, blue, green & clear
- IP-23 rated.

- LEDs consume less power.
- 70mm diameter.
- Optional buzzer.
- LED modules are interchangeable and stackable after purchase.
- Colors: red, yellow, green, blue & clear.
- IP-23 rated.



PHE

The PHE-3FB

PC-controlled Signal Tower Light—

The PHE-3FB is controlled through the RS232C port on your personal computer.

PC Controlled Light

PHE-3FB

Specifications

Voltage	24V DC (AC Adapter included)
Power Consumption (Max.)	Approx. 6.5W
Input Interface	RS-232C (or USB with converter)
Weight	PHE-3FB: 580g AC Adapter: 160g

Dimensions (mm)

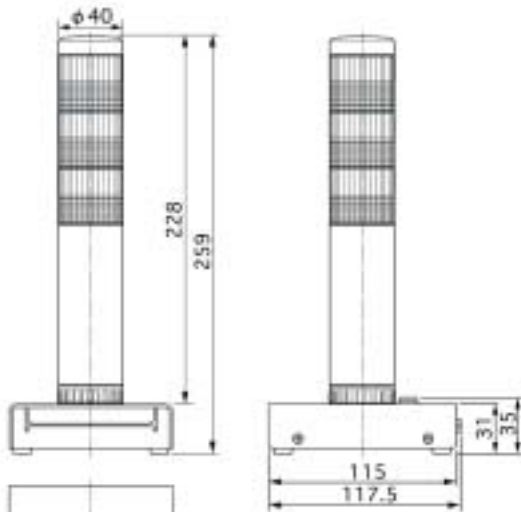

AC Adapter

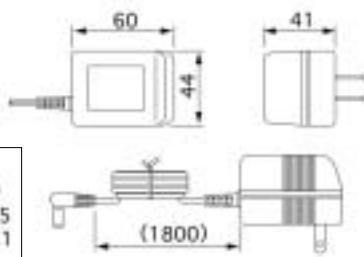

Application examples:

- ✓ To supervise your personal computer, server and/or workstation.
- ✓ To indicate the status of a process.
- ✓ RFID applications.

LED Type Light

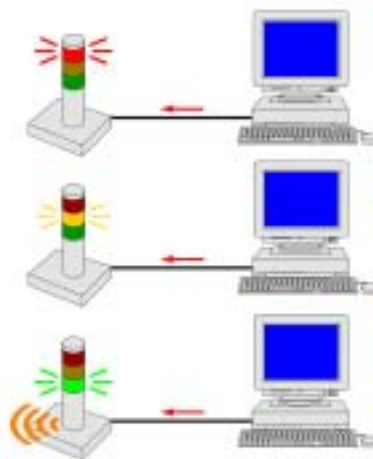

- Easy to program.
- Connect with RS232C cable directly to your PC, or by USB with converter.
- Two selectable single-tone, intermittent alarms with adjustable volume to 85dB (at 1m).
- Light has continuous and flashing options.
- A reset switch can resume the system to the original status.
- Light uses Patlite's unique Double Reflection LED system to create full and brilliant color.
- To see the Control Protocols, go to www.patlite.com.
- RS232C straight-through cable required.
- Comes with standard light configuration: red/yellow/green.

PATLITE ME

Super Slim Size

MES-T 40mm Body Size

ME-T 200mm Body Size

If longer pole is required, 500mm body size available by special order only.

STYLE	MODEL	RATED VOLTAGE	WATTAGE
1 LIGHT	ME / MES -102T	24V DC	0.6W
2 LIGHT	ME / MES -202T	24V DC	1.2W
3 LIGHT	ME / MES -302T	24V DC	1.7W
4 LIGHT	ME / MES -402T	24V DC	2.2W
5 LIGHT	ME / MES -502T	24V DC	2.7W

12V DC version available by special order.

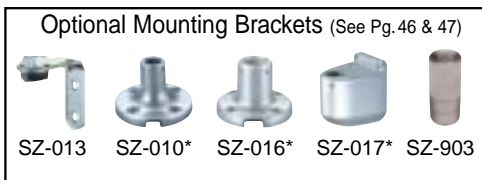

* Requires SZ-903 Adapter

NOTE: See pages 22 & 23 for wiring and dimensions.

ME Series Super Slim Indicating Light— The ME Series are direct mounted, super slim lights with rust free aluminum bodies.

LED Type Light
CE cULUS

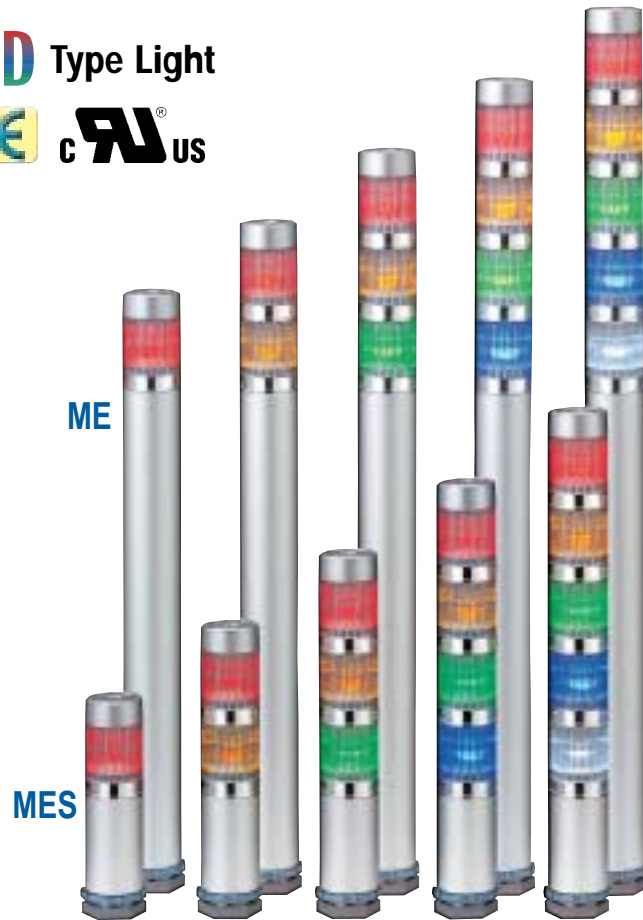

ø25mm

- Colors available: red, yellow, green, blue, and clear.
- Lenses are clear (no color) until power supplied.
- Rust & corrosion proof anodized aluminum tower body.
- Can be mounted on a flat surface with a single hole.
- IP-54 rating, and NPN open collector compatible.
- PNP open collector version is available by special order (minimum 5 pieces per order).
- Standard body size: 200mm ME.
Shorter body size: 40mm MES.
- Includes lock nut and chase nipple.
- LED modules are interchangeable and stackable after purchase (up to 5 LED modules).

PATLITE LCE

LCE Series Indicating Light—

The LCE Series offers the latest in LED technology. Versatile and energy efficient.

Pole Mount

LCE(-T) Continuous Light

LCE(-T)FB Continuous and Flashing Light with Audible Alarms

Direct Mount

LCE(-T)W Continuous Light

LCE(-T)FBW Continuous and Flashing Light with Audible Alarms

STYLE	MODEL	RATED VOLTAGE	WATTAGE
1 LIGHT	Direct Mount LCE-102TW / TFBW	24V AC/DC	1.7W
	Pole Mount LCE-102T / TFB		
	Direct Mount LCE-1M2W / FBW	90 to 250V AC	1.9W
2 LIGHT	Direct Mount LCE-202TW / TFBW	24V AC/DC	2.4W
	Pole Mount LCE-202T / TFB		
	Direct Mount LCE-2M2W / FBW	90 to 250V AC	2.6W
3 LIGHT	Direct Mount LCE-302TW / TFBW	24V AC/DC	3.0W
	Pole Mount LCE-302T / TFB		
	Direct Mount LCE-3M2W / FBW	90 to 250V AC	3.2W
4 LIGHT	Direct Mount LCE-402TW / TFBW	24V AC/DC	3.6W
	Pole Mount LCE-402T / TFB		
	Direct Mount LCE-4M2W / FBW	90 to 250V AC	3.8W
5 LIGHT	Direct Mount LCE-502TW / TFBW	24V AC/DC	4.2W
	Pole Mount LCE-502T / TFB		
	Direct Mount LCE-5M2W / FBW	90 to 250V AC	4.4W

Optional Mounting Brackets (See Pg. 46 & 47)



* Requires SZ-903 Adapter

NOTE: See pages 22 & 23 for wiring and dimensions.

LED Type Light  

LCE-W



LCE



ø40mm

- Colors available: red, yellow, green, blue, and clear.
- *LCE & LCE-FB/FBW types: IP-54. LCE-W: IP-65.
- Super high intensity LEDs and low operating costs, low power consumption & maintenance free.
- FB types: Two selectable single-tone, intermittent alarms with adjustable volume to 85dB (at 1m).
- Pole mount types include 300mm steel pole and mounting bracket (SZ-012) with nuts and washers.
- NPN or PNP open collector compatible (24V type), and NPN open collector compatible (90-250V type).
- Free-voltage style available, 90 to 250V AC.
- LED modules are interchangeable and stackable after purchase (up to 5 LED modules).

PATLITE LES

Pole Mount

LES-A Continuous Light

Direct Mount

LES-AW Continuous Light

STYLE	MODEL	RATED VOLTAGE	WATTAGE
1 LIGHT	Direct Mount	LES-102AW	24V AC/DC 0.8W
	Pole Mount	LES-102A	
2 LIGHT	Direct Mount	LES-202AW	24V AC/DC 1.2W
	Pole Mount	LES-202A	
3 LIGHT	Direct Mount	LES-302AW	24V AC/DC 1.7W
	Pole Mount	LES-302A	
4 LIGHT	Direct Mount	LES-402AW	24V AC/DC 2.2W
	Pole Mount	LES-402A	
5 LIGHT	Direct Mount	LES-502AW	24V AC/DC 2.7W
	Pole Mount	LES-502A	

Note:

- LED modules cannot be added after purchase.
- Bottom LED module cannot be removed or interchanged.

(Consult with factory if other combinations are required)

Optional Mounting Brackets (See Pg. 46 & 47)



*Requires SZ-903 adapter

NOTE: See pages 22 & 23 for wiring and dimensions.

LES Series Indicating Light—

The LES Series is a quality, cost saving, LED signal tower with prices below incandescent.

LED Type Light  



ø50mm

- Colors available: red, yellow, green, blue, and clear.
- *Meets IP-54 (Sealant required for mounting pole and bracket).
- Features high intensity LEDs, offering low costs, low power consumption and maintenance free.
- Lenses are made of acrylic resin.
- NPN or PNP open collector compatible.
- Units are shipped completely pre-wired and pre-assembled.
- Pole mount type includes 300mm steel pole and mounting bracket (SZ-012) with nuts and washers.

PATLITE

LE

LE Series Indicating Light—

The LE Series can mount up to five colors, and has an improved alarm and LED system.

Pole Mount

LE-P Continuous Light

LE-FBP Continuous and Flashing Light with Audible Alarms

Direct Mount

LEL-W Continuous Light

LEL-FBW Continuous and Flashing Light with Audible Alarms

LED Type Light
 



Available with DeviceNet or As-i

DIRECT MOUNT TYPE			
STYLE	MODEL	RATED VOLTAGE	WATTAGE
1 LIGHT	LEL-101W / FBW	12V AC/DC	1.1W
	LEL-102W / FBW	24V AC/DC	1.8W
	LEL-112W / FBW	120V AC	5.7W
2 LIGHT	LEL-201W / FBW	12V AC/DC	1.7W
	LEL-202W / FBW	24V AC/DC	3.2W
	LEL-212W / FBW	120V AC	6.7W
3 LIGHT	LEL-301W / FBW	12V AC/DC	3.2W
	LEL-302W / FBW	24V AC/DC	3.7W
	LEL-312W / FBW	120V AC	7.5W
4 LIGHT	LEL-401W / FBW	12V AC/DC	3.7W
	LEL-402W / FBW	24V AC/DC	3.2W
	LEL-412W / FBW	120V AC	6.3W
5 LIGHT	LEL-501W / FBW	12V AC/DC	3.2W
	LEL-502W / FBW	24V AC/DC	3.7W
	LEL-512W / FBW	120V AC	8.1W

FD type flashes 50 times per minute.

POLE MOUNT TYPE			
STYLE	MODEL	RATED VOLTAGE	WATTAGE
1 LIGHT	LE-101P / FBP	12V AC/DC	1.1W
	LE-102P / FBP	24V AC/DC	1.8W
2 LIGHT	LE-201P / FBP	12V AC/DC	1.7W
	LE-202P / FBP	24V AC/DC	3.2W
3 LIGHT	LE-301P / FBP	12V AC/DC	3.2W
	LE-302P / FBP	24V AC/DC	3.7W
4 LIGHT	LE-401P / FBP	12V AC/DC	3.7W
	LE-402P / FBP	24V AC/DC	3.2W
5 LIGHT	LE-501P / FBP	12V AC/DC	3.2W
	LE-502P / FBP	24V AC/DC	3.7W

ø50mm

- Colors available: red, yellow, green, blue, and clear.
- *IP Rating: Direct Mount IP-54, Pole Mount IP-23.
- LED modules are interchangeable and stackable after purchase (up to 5 LED modules).
- FB type: Two selectable single-tone, intermittent alarms with adjustable volume to 85dB (at 1m).
- LE-P: Includes 300mm steel pole with nuts and washers (optional brackets available).
- 12V version is only available by special order.
- NPN or PNP open collector compatible for 24V, NPN for 120V.
- See page 8 for DeviceNet™ or As-i versions.



Optional custom poles up to 1000mm available (SL-1000mm)
 *Requires SZ-903 adapter

NOTE: See pages 22 & 23 for wiring and dimensions.

PATLITE

SE

SE-T Series Indicating Light—

The SE-T Series LED Signal Tower is brighter than ever!

Pole Mount

SE-T Continuous Light

SEFB-T Continuous and Flashing Light with Audible Alarms

STYLE	MODEL	RATED VOLTAGE	WATTAGE
1 LIGHT	SE / SEFB -102T	24V AC/DC	1.5W
	SE / SEFB -112T	120V AC	3.0W
2 LIGHT	SE / SEFB -202T	24V AC/DC	2.5W
	SE / SEFB -212T	120V AC	5.0W
3 LIGHT	SE / SEFB -302T	24V AC/DC	3.5W
	SE / SEFB -312T	120V AC	6.5W
4 LIGHT	SE / SEFB -402T	24V AC/DC	4.5W
	SE / SEFB -412T	120V AC	7.5W
5 LIGHT	SE / SEFB -502T	24V AC/DC	5.5W
	SE / SEFB -512T	120V AC	8.5W

220V AC version available by special order only.

Optional Mounting Brackets (See Pg. 46 & 47)



NOTE: See pages 22 & 23 for wiring and dimensions.

LED Type Light



ø57mm

- Colors available: red, yellow, green, blue, and clear.
- IP Rating: IP-54.
- LED modules are interchangeable and stackable after purchase (up to 5 LED modules).
- FB type: Two selectable single-tone, intermittent alarms with adjustable volume to 90dB (at 1m).
- NPN or PNP open collector compatible (24V type), and NPN open collector compatible (120/220V type).
- The units are shipped completely pre-wired and pre-assembled.
- Includes 300mm steel pole and mounting bracket (SZ-013) with nuts and washers.



LME

LME Series Indicating Light— The LME Series provides the latest in LED technology.

Pole Mount

LME-T Continuous Light

LME-TFB Continuous and Flashing Light with Audible Alarms

Direct Mount

LME-TW Continuous Light

LME-TFBW Continuous and Flashing Light with Audible Alarms

STYLE	MODEL	RATED VOLTAGE	WATTAGE
1 LIGHT	Direct Mount LME-102TW / TFBW	24V AC/DC	2.2W
	Direct Mount LME-112TW / TFBW	120V AC	5.1W
	Pole Mount LME-102T / TFB	24V AC/DC	2.2W
	Pole Mount LME-112T / TFB	120V AC	5.1W
2 LIGHT	Direct Mount LME-202TW / TFBW	24V AC/DC	3.4W
	Direct Mount LME-212TW / TFBW	120V AC	7.1W
	Pole Mount LME-202T / TFB	24V AC/DC	3.4W
	Pole Mount LME-212T / TFB	120V AC	7.1W
3 LIGHT	Direct Mount LME-302TW / TFBW	24V AC/DC	3.8W
	Direct Mount LME-312TW / TFBW	120V AC	7.9W
	Pole Mount LME-302T / TFB	24V AC/DC	3.8W
	Pole Mount LME-312T / TFB	120V AC	7.9W
4 LIGHT	Direct Mount LME-402TW / TFBW	24V AC/DC	4.2W
	Direct Mount LME-412TW / TFBW	120V AC	8.7W
	Pole Mount LME-402T / TFB	24V AC/DC	4.2W
	Pole Mount LME-412T / TFB	120V AC	8.7W
5 LIGHT	Direct Mount LME-502TW / TFBW	24V AC/DC	4.6W
	Direct Mount LME-512TW / TFBW	120V AC	9.9W
	Pole Mount LME-502T / TFB	24V AC/DC	4.6W
	Pole Mount LME-512T / TFB	120V AC	9.9W

LED Type Light  

ø60mm

- Colors available: red, yellow, green, blue, and clear.
- *IP Rating: IP-65 / (FB Type: IP-54).
- LED modules are interchangeable and stackable after purchase, up to 5 LED modules (New shaft purchase is required).
- FB type: Two selectable single-tone, intermittent alarms with adjustable volume to 90dB (at 1m).
- Pole mount version comes with 300mm aluminum pole and plastic topmount bracket.
- NPN or PNP open collector (24V type), and NPN open collector (120V type).



Direct Mount

Optional Mounting Brackets (See Pg. 46 & 47)



NOTE: See pages 22 & 23 for wiring and dimensions.

LME-Q

The LME-Q Series — Four colors in a single stack

Pole Mount

LME-T-Q Continuous Light

LME-TFB-Q Continuous and Flashing Light with Audible Alarms

Direct Mount

LME-TW-Q Continuous Light

LME-TFBW-Q Continuous and Flashing Light with Audible Alarms

LED Type Light  

- 3 color combinations available:
Q1 : Red/Yellow/Green/Blue
Q2 : Red/Yellow/Green/Clear
Q4 : Yellow/Green/Blue/Clear
- Most features are the same as the LME series (see above).



Direct Mount

NOTE: See pages 22 & 23 for wiring and dimensions.

STYLE	FB	MODEL	RATED VOLTAGE	WATTAGE	
1 LIGHT	DIRCT MOUNT	W/O	LME-102TW-Q1 (2 or 4)	24V DC	2.2W
	DIRCT MOUNT	W/TH	LME-102TFBW-Q1 (2 or 4)	24V DC	2.2W
	POLE MOUNT	W/O	LME-102T-Q1 (2 or 4)	24V DC	2.2W
		W/TH	LME-102TFB-Q1 (2 or 4)	24V DC	2.2W
	DIRCT MOUNT	W/O	LME-112TW-Q1 (2 or 4)	120V AC	5.1W
		DIRCT MOUNT	W/TH	LME-112TFBW-Q1 (2 or 4)	120V AC
POLE MOUNT	W/O	LME-112T-Q1 (2 or 4)	120V AC	5.1W	
	POLE MOUNT	W/TH	LME-112TFB-Q1 (2 or 4)	120V AC	5.1W

FB type features 60 tones per minute.



ø70mm Round	IP-65	90 dB/m	Electronic Alarms: 2	Vibration Resistant	Open-Collector Compatible	Modular
-------------	-------	---------	----------------------	---------------------	---------------------------	---------

LU7

LU7 Series

Modular System Indicating Light—
is perfect for OEMs that offer different multi-stack versions in their machine design.

Direct Mount

LU7 Continuous Light

LU7-FB Continuous and Flashing Light with Audible Alarms

How to Order:

Base Module (including cap)		
Model	Rated Voltage	Alarm / Flash
LU7-02	24V DC	—
LU7-02FB	24V DC	2 Alarms / Flash
LU7-M2	90~250V AC	—
LU7-M2FB	90~250V AC	2 Alarms / Flash

LED Module	
Model	Color
LU7-E-R	Red
LU7-E-Y	Yellow
LU7-E-G	Green
LU7-E-B	Blue
LU7-E-C	Clear

LED Type Light



Terminal Base



Assembly Required

ø70mm

- No tools required to assemble.
- Easy wiring with spring loaded terminal block.
- NPN or PNP open collector compatible (24V type), and NPN open collector compatible (90-250V type).
- Available in 24V DC and Free-Voltage, 90 to 250V AC.
- FB type: Two selectable single-tone alarms, one intermittent and one continuous, with adjustable volume to 90dB (at 1m), and light has 60 flashes per minute.
- Pole mount options available: SZ-50L, SZ-50T (see pages 46-47).
- Once mounted on a machine, the tower can easily be removed from the terminal base for shipping, and re-installed without tools.

Terminal Wiring Chart

Terminal Number	Corresponding Unit or Operation	Ref: Wiring Diagrams (Page 22)	
		Diagrams 1 & 2	Diagram 3
CN2-1	Red LED Unit	Light Wire 1	Light Wire 1
CN2-2	Yellow LED Unit	Light Wire 2	Light Wire 2
CN2-3	Green LED Unit	Light Wire 3	Light Wire 3
CN2-4	Blue LED Unit	Light Wire 4	Light Wire 4
CN2-5	Clear LED Unit	Light Wire 5	Light Wire 5
CN2-6	Continuous Alarm	Alarm 1	Alarm 1
CN2-7	Intermittent Alarm	Alarm 2	Alarm 2
CN2-8	Power Supply	Power 1	Continuous Common
CN2-9	Flashing Common	Flashing Common	Flashing Common
CN2-10	Power Supply	Power 2	N / A
CN4-1	High Voltage Supply	N / A	Power 1
CN4-2	High Voltage Supply	N / A	Power 2
CN5	Earth Ground	N / A	Earth Ground

Wire Sizes: CN2-(1-10): AWG 26-20, UL1007, UL1430
CN4-1, CN4-2: AWG 18-16, UL1015
CN5: AWG 18-14, UL1015

Terminal Diagram

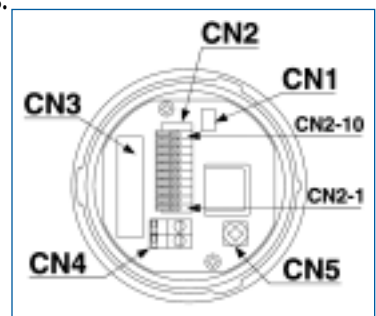

NOTE: See page 23 for dimensions.

PATLITE LGE

Light Modules

LGEM



Power Units

LGEBC

Continuous Light

LGEBC-FB

Continuous and Flashing Light with Audible Alarm

Shaft Assembly

LGSHAFT

LIGHT-MODULE

LIGHT UNIT	COLOR	RATED VOLTAGE	WATTAGE
LGEM-24-R	RED	24V AC/DC	2W
LGEM-24-Y	YELLOW		
LGEM-24-G	GREEN		
LGEM-24-B	BLUE		
LGEM-24-C	CLEAR		

POWER UNIT

POWER UNIT	RATED VOLTAGE	TYPE OPERATION
LGEBC-120	120V AC	Continuous
LGEBC-24	24V AC/DC	Continuous
LGEBC-120FB	120V AC	Continuous / Flashing with Audible Alarm option
LGEBC-24FB	24V AC/DC	Continuous / Flashing with Audible Alarm option

SHAFT ASSEMBLY

PART NO.	LIGHT-MODULES PER BASE UNIT
LGSHAFT-1	1
LGSHAFT-2	2
LGSHAFT-3	3
LGSHAFT-4	4

NOTE: See pages 22 & 23 for wiring and dimensions.

LGE Series Large Indicating Light— The LGE Series is suitable for larger machines. Increased visibility at great distances with a modular design.

LED Type Light

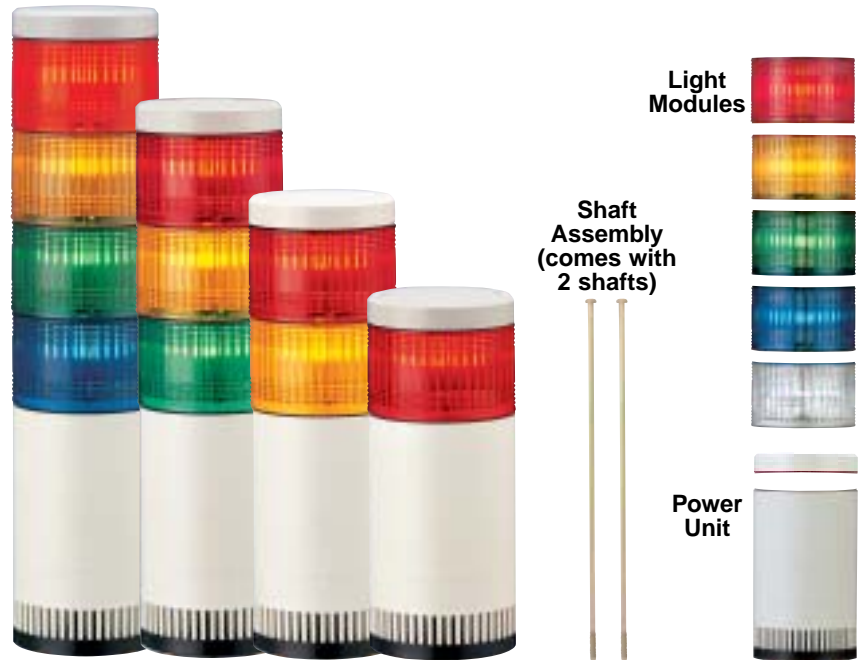

Assembly Required

ø100mm

- Colors available: red, yellow, green, blue, and clear (Blue and Clear LEDs are at a premium).
- *Meets IP-54 (Sealant required for wire entry hole and mounting area).
- Units are stackable up to 4 lights (New shaft purchase is required).
- Large diameter signal tower is visible from great distances, with lens dimensions: 100mm x 50mm.
- Available with flashing and an audible alarm of 85dB (at 1m).
- NPN or PNP open collector compatible (24V DC only).

How to Order (Example)

Three LED lights (Red, Yellow, Green) with flashing at input voltage of 120V AC:

1. Power Unit: LGEBC-120FB x 1 pc
2. Light Module: LGEM24-R x 1 pc
LGEM24-Y x 1 pc
LGEM24-G x 1 pc
3. Shaft Assembly: LGSHAFT-3 x 1 pc

Note: LGEBC contains a transformer that steps down the input voltage to 24V DC.

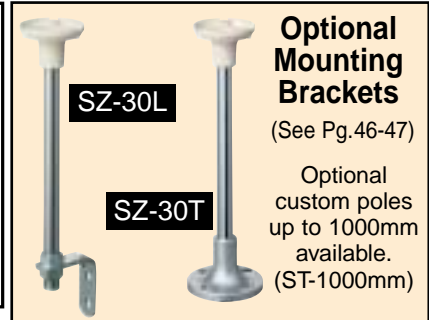

Optional Mounting Brackets

(See Pg.46-47)

Optional custom poles up to 1000mm available. (ST-1000mm)

PATLITE WE

WE Series Wall mounted Indicator—
The WE Series are Ultra-Slim Signal Lights that offer seamless integration with equipment.

Wall Mount

WE-T Continuous Light

WE-TFB Continuous and Flashing Light with Audible Alarms

WEP-T Continuous Light

WEP-TFB Continuous and Flashing Light with Audible Alarms

STYLE	MODEL	RATED VOLTAGE	WATTAGE
3 LIGHT	WE / WEP-302T-RYG	24V AC/DC	1.7 W
	WE / WEP-302T-RYB		
	WE / WEP-302T-RYC		
4 LIGHT	WE / WEP-302TFB-RYG	24V AC/DC	2.7 W
	WE / WEP-302TFB-RYB		
	WE / WEP-302TFB-RYC		
4 LIGHT	WE / WEP-402T-RYGB	24V AC/DC	2.0 W
	WE / WEP-402T-RYGC		
	WE / WEP-402T-CYGB		
5 LIGHT	WE / WEP-402TFB-RYGB	24V AC/DC	3.2 W
	WE / WEP-402TFB-RYGC		
	WE / WEP-402TFB-CYGB		
5 LIGHT	WE / WEP-502T-RYGBG	24V AC/DC	2.7 W
	WE / WEP-502TFB-RYGBG		

FB type: 60 flashes / minute.

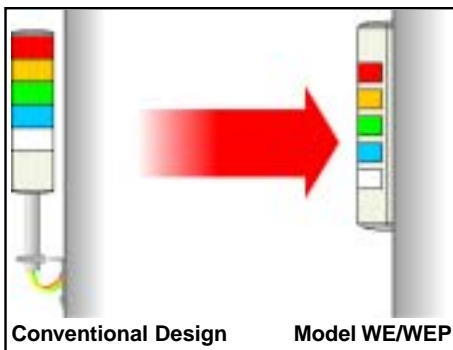

IP-65 construction is safe for wash-down environments.

LED Type Light **CE** **c** **UL** **us**



37.5mm Profile

- Colors available: red, yellow, green, blue, and clear.
- *IP Rating: IP-65 / FB type: IP-54 (FB type must be installed with alarm opening downward).
- FB type: Two selectable single-tone, intermittent alarms with volume 90dB (at 1m).
- Mounting: Vertical or Horizontal positions.
- NPN or PNP open collector compatible.
- See page 8 for DeviceNet™ and As-i versions.

NOTE: See pages 22 & 23 for wiring and dimensions.

PATLITE WM

LED Type

WME-A Continuous Light

WME-AFB Continuous and Flashing Light with Audible Alarms

Bulb Type

WM-T Continuous Light

WM-TFB Continuous and Flashing Light with Audible Alarm

LED Type:

STYLE	MODEL	RATED VOLTAGE	WATTAGE
2 LIGHT	WME-202A / WME-202AFB	24V AC/DC	See Note Below*
	WME-2M2A / WME-2M2AFB	90-250V AC	See Note Below*
3 LIGHT	WME-302A / WME-302AFB	24V AC/DC	See Note Below*
	WME-3M2A / WME-3M2AFB	90-250V AC	See Note Below*
4 LIGHT	WME-402A / WME-402AFB	24V AC/DC	See Note Below*
	WME-4M2A / WME-4M2AFB	90-250V AC	See Note Below*
5 LIGHT	WME-502A / WME-502AFB	24V AC/DC	See Note Below*
	WME-5M2A / WME-5M2AFB	90-250V AC	See Note Below*

*NOTE:

Wattage for WME-A		
	24V AC/DC	90-250V AC
Red	0.6W	1.1W
Yellow	0.7W	1.1W
Green	0.5W	1.1W
Blue	1.0W	1.5W
Clear	1.0W	1.5W
Buzzer	1.0W	1.4W
Waiting	—	0.6W

Bulb Type:

STYLE	MODEL	RATED VOLTAGE	BULB	No.
2 LIGHT	WM-202T / WM-202TFB	24V AC/DC	28V 11W	39
	WM-212T / WM-212TFB	120V AC	140V 12W	49
3 LIGHT	WM-302T / WM-302TFB	24V AC/DC	28V 11W	39
	WM-312T / WM-312TFB	120V AC	140V 12W	49
4 LIGHT	WM-402T / WM-402TFB	24V AC/DC	28V 11W	39
	WM-412T / WM-412TFB	120V AC	140V 12W	49
5 LIGHT	WM-502T / WM-502TFB	24V AC/DC	28V 11W	39
	WM-512T / WM-512TFB	120V AC	140V 12W	49

(Note) - 200-240V AC version available by special order.

WM Series Wall Mounted Indicator—

The WM Series solves your space problems! Designed for easy mounting to save you both time and money.



80mm Profile

- Colors available: red, yellow, green, blue, and clear.
- *IP Rating: IP-65 (FB versions, upright only).
- Can be mounted vertically or horizontally to either front panel or ceilings.
- Alarms: WME-AFB type includes two selectable, single-tone intermittent alarms with volume 80dB (at 1m), while WM-TFB type has 1 alarm with an alternating 2-tone.
- FB types: approx. 60 flashes per minute.
- WME-A types: Free-voltage style available, 90 to 250V AC.
- NPN or PNP open collector compatible (24V DC only).
- 1 stack versions available by special order for WME-A/AFB.

NOTE: See pages 22 & 23 for wiring and dimensions.

WSL

Manual Indicating Light

WSL Continuous Light

WSLF Continuous and Flashing Light with Audible Alarms

WSL Type:

MODEL	OVERALL HEIGHT(mm)	Color
WSL-3W-RYG (wall)	535	RED/YELLOW/GREEN
WSL-3D-RYG (desk)	487	RED/YELLOW/GREEN
WSL-4W-RYGB (wall)	565	RED/YELLOW/GREEN/BLUE
WSL-4D-RYGB (desk)	517	RED/YELLOW/GREEN/BLUE

WSLF Type:

MODEL	OVERALL HEIGHT(mm)	Color
WSLF-3W-RYG (wall)	587	RED/YELLOW/GREEN
WSLF-3D-RYG (desk)	539	RED/YELLOW/GREEN
WSLF-4W-RYGB (wall)	617	RED/YELLOW/GREEN/BLUE
WSLF-4D-RYGB (desk)	569	RED/YELLOW/GREEN/BLUE

HSST

Manual Indicating Light

HSST-312-RYG Continuous Light

The HSST-312 kit, complete as shown below:



WSL Series and HSST Work Station Lights—

LED Type Light

Application Examples:

- ✓ *Assembly workstation process indicator.*
- ✓ *Office and warehouse employee status indicator light.*
- ✓ *Cashier and bank teller availability light.*
- ✓ *Any type of manually operated assembly shop.*

NOTE: See page 23 for WSL dimensions.



WSL-3W-RYG
Wall Mount

WSL-3D-RYG
Desktop

ø50mm

- WSL/WSLF colors available: red, yellow, green, blue, and clear. HSST standard colors: red, yellow, and green.
- LED illuminating light offers maintenance-free operation.
- AC power adapter makes set-up easy in any location. (UL Listed)
- WSL/WSLF come with durable steel control box with rocker switches and 2 pole mounting options.
- WSL : Optional pole up to 1,000mm (SL-1000) available.
- WSLF version includes two separate alarms, and alarm can be added to one or all colors.
- HSST comes as a complete kit which includes:
 - 3 LED signal tower in red/yellow/green with 4 ft. cable.
 - 120V AC power supply with 6 ft. cord length.
 - 3 button switchbox with mounting screws.
 - 2 position mounting bracket with 2 adjustment screws.
 - 3 and 12 inch mounting poles.
 - Extension cable available in 10 ft. segments (DT-HSST-10).



XP

The XP-24— Large, durable strobe

Large Strobe

MODEL	RATED VOLTAGE	POWER CONSUMPTION	RECOMMENDED FUSE	FLASHES PER MINUTE	WEIGHT
XP-24	24V DC	17W	5A	110	1.3Kg

Note: Average power consumption shown. Fuse rating reflects momentary peak current drawn by Xenon lamp.

Dimensions (mm)

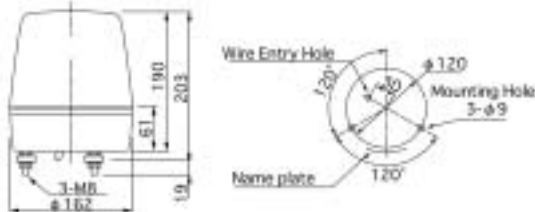

WIRE LENGTH: 300

Wiring Diagram



ø162mm Round	Xenon	Pre-Assembled Pre-Wired
--------------	-------	-------------------------

Xenon Type Light



ø162mm

- Rated Voltage: 24V DC.
- Colors available: red, yellow and blue.
- Large design increases visibility over standard strobe products.
- Xenon discharge tube provides superior visibility at great distances and is not affected by vibration.
- Lenses are made of AS resin with superior weather resistance and light translucence.
- Main body is made of ABS resin with superior resistance to impact and heat.

KX

KX Series Signal Light—

The KX Series, with Xenon discharge tube, lamp life is not affected by vibration. Superior visibility.

Mini-Size Flashing

MODEL	RATED VOLTAGE	POWER CONSUMPTION	RECOMMENDED FUSE	FLASHES PER MINUTE	WEIGHT
KX-12T	12V DC	8W	125V, 3A	30~90	0.42Kg
KX-24T	24V DC		125V, 1A		
KX-120T	120V AC	4W	250V, 0.5A		0.40Kg

Note: Average power consumption shown. Fuse rating reflects momentary peak current drawn by Xenon lamp.

Dimensions (mm)

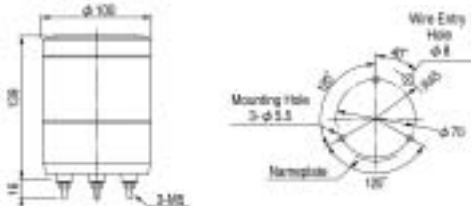

WIRE LENGTH: 250

ø100mm Round	IP-55* IP-23*	Xenon	Pre-Assembled Pre-Wired
--------------	------------------	-------	-------------------------

Xenon Type Light



ø100mm

- Colors: red, yellow, green, blue, and clear.
- Xenon lamp provides intense flash (night-time visibility 1000m or more).
- *Meets IP-23 (IP-55 with optional rubber gasket SZ-200).
- Adjustable flash rate: 30~90 flashes per minute.
- 12V and 220V versions only available by special order.



NOTE: See page 31 for wiring diagram.

Signal Tower Wiring Diagrams

Refer to the tables and wiring diagrams below, to determine wiring, wire colors and voltages available

⚠ Please Note: Light wire colors correspond to LED module colors, except that the Orange Wire is used for the Yellow Light.

Diagram #1— Continuous Only

DIAGRAM #1		WIRE COLORS	
Continuous Towers	Rated Voltage	Power 1	
MT, WM	24 / 120	Yellow	
LE, LEL, LES	24	Black	
LCE, LME, LME-Q, ME, MES, SE, WE, WEP, WME-A	24	Yellow	

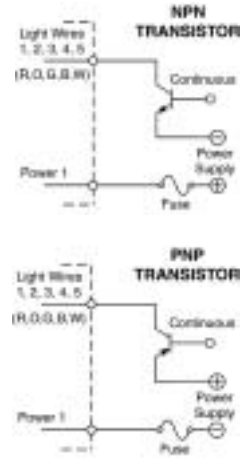
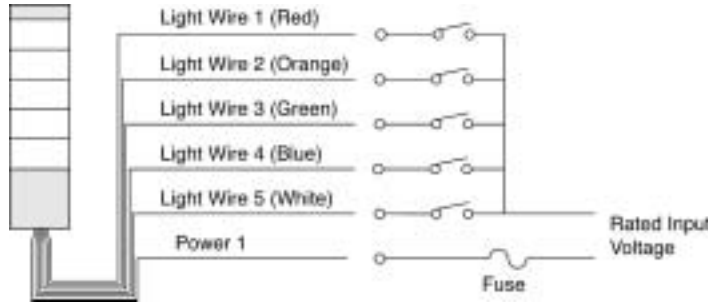

ME, MEL, MES Series: 24VDC only, with only one polarity: plus (+) on Yellow (NPN).

Opposite polarity with minus (-) on Yellow (PNP) is available by special order only.

LME-Q Series: 24V model is DC only, with only one polarity: plus (+) on Yellow (NPN).

MT Series: 12V model also available.

Diagram #2— Continuous and Flashing with Alarm(s)

DIAGRAM #2		WIRE COLORS	
Continuous and Flashing with Alarm(s)	Rated Voltage	1. Power 1 2. Power 2	1. Alarm 1 2. Alarm 2
WM-FB	24 / 120	1. Yellow 2. Gray	1. Sky Blue 2. None
LE-FB LEL-FB	24	1. Black 2. Gray	1. Purple 2. Sky Blue
LCE-FB, LME-FB, LME-FB-Q, SEFB, WE-FB, WEP-FB, WME-AFB	24	1. Yellow 2. Gray	1. Purple 2. Sky Blue

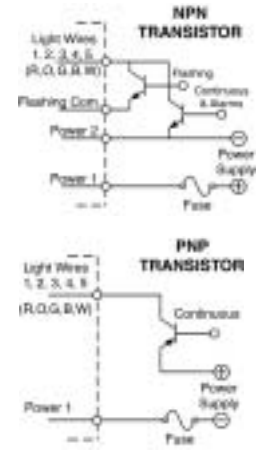
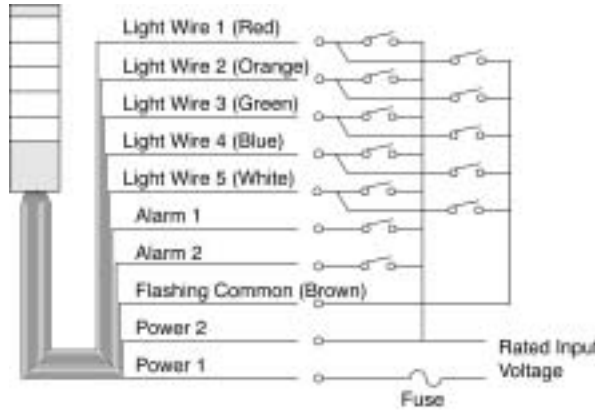

LME-FB-Q Series: 24V model is DC only, with only one polarity: plus (+) on Yellow (NPN).

Diagram #3— Continuous or Continuous and Flashing with Alarm(s)

DIAGRAM #3		WIRE COLORS	
Continuous or Continuous and Flashing with Alarm(s)	Rated Voltage	1. Power 1 2. Power 2	1. Alarm 1 2. Alarm 2
LGE, LGE-FB	24 / 120	1. Black 2. White	1. Sky Blue 2. None
LEL, LCE, SE, LME, LME-Q, WME-A	120	1. Black 2. Gray	1. None 2. None
LCE-FB, LEL-FB, LME-FB, LME-FB-Q, SEFB, WME-AFB	120	1. Black 2. Gray	1. Purple 2. Sky Blue

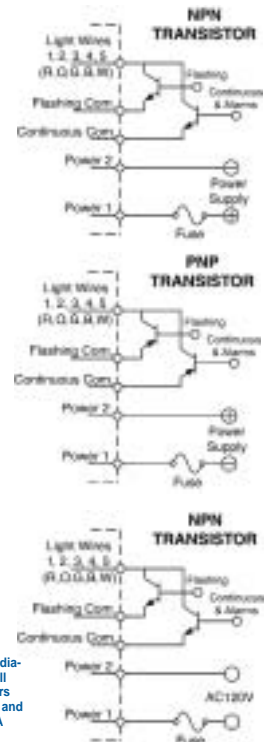
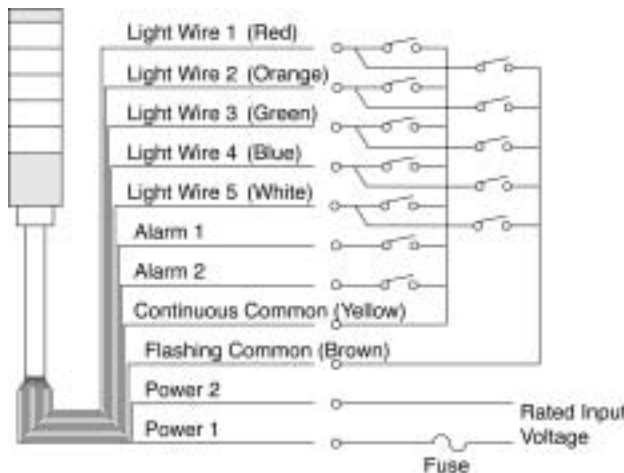

LGE Series: All wires come with the unit, but for the Continuous Only version, the Brown and Sky-blue wires are not used.

LEL, LME, LME-Q, LCE, SE, WME-A Series: Continuous Only version does not include the Flashing Common (Brown) wire.

LCE Series and WME-A: Free-Voltage version (AC90-250V model) includes ground wire (Green/Yellow).

NOTES:

1. Transistors, switches and fuses shown are to be supplied by the customer.
2. Fuse rating is 1A (WM-24V model has a 3A fuse).
3. The WM and LGE Series have a fuse installed internally.
4. Never connect Brown to Gray.
5. Open-collector transistor control is for 24VDC or 120VAC units except where noted.
6. All 5 light wires are supplied even if not all colors are used, except for the following: MT, WE / WEP, WM, and LES Series.

This transistor diagram is for all AC120V towers except the LGE and WM / WME-A Series.

Signal Tower Dimensions

Refer to the diagrams below to determine Signal Tower dimensions (in mm)

ME

WIRE LENGTH:
ME: 300
MES: 460

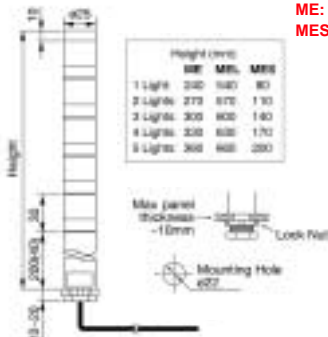

LGE

WIRE LENGTH:
LGE: 400

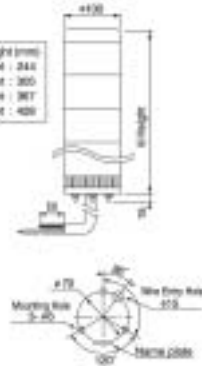

SE

WIRE LENGTH:
SE(FB)-T: 300

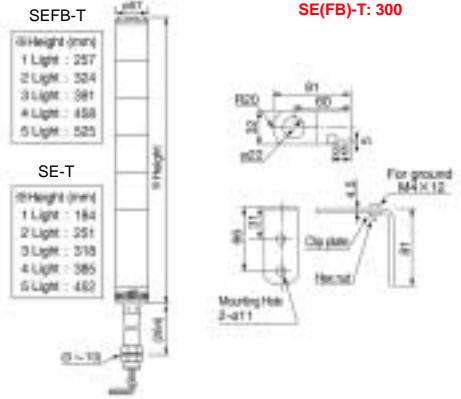

LCE

WIRE LENGTH:
LCE: 950
LCE-W: 1250

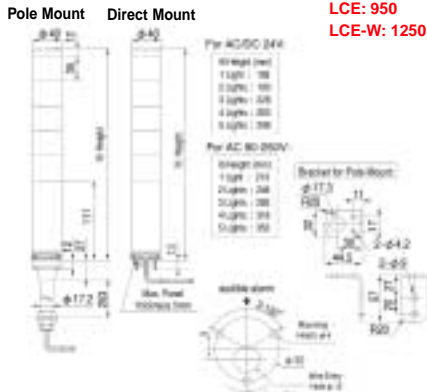

LME

WIRE LENGTH:
LME: 950
LME-W: 1250

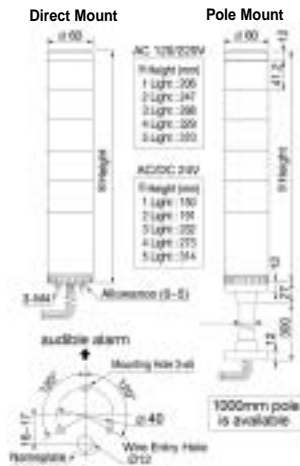

LME-Q

WIRE LENGTH:
LME-Q: 900
LME-W-Q: 1200

WE

WIRE LENGTH:
WE/WEP: 1000

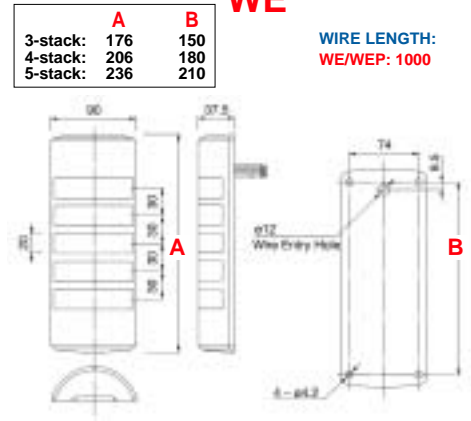

LES

WIRE LENGTH:
LES-A: 900
LES-AW: 1250

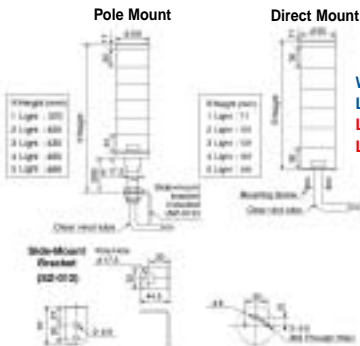

ST / STPB STF / STFPB

WIRE LENGTH: 300

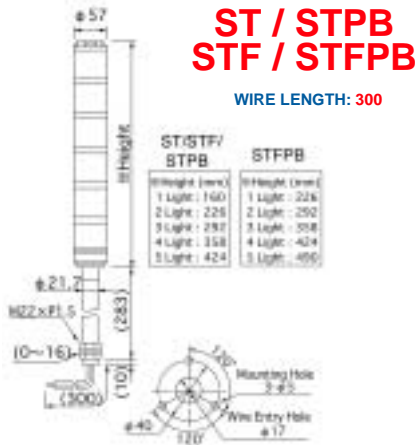

WM

WIRE LENGTH:
WM/WME-A: 900

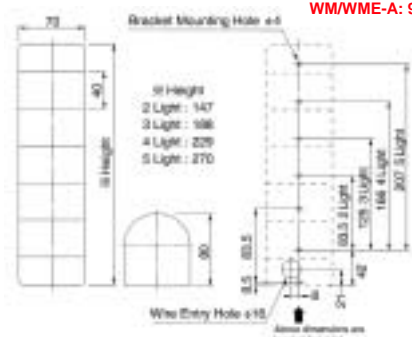

LE

WIRE LENGTH:
LE-P: 650
LEL: 700

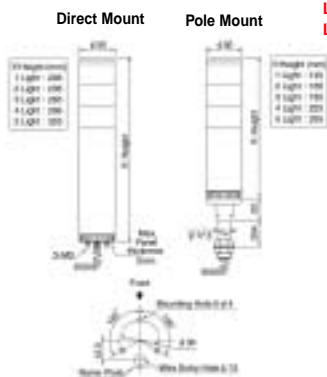

LU7

TERMINALS PROVIDED

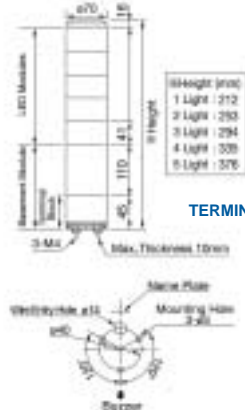

WSL

POWER CABLE LENGTH: 1800

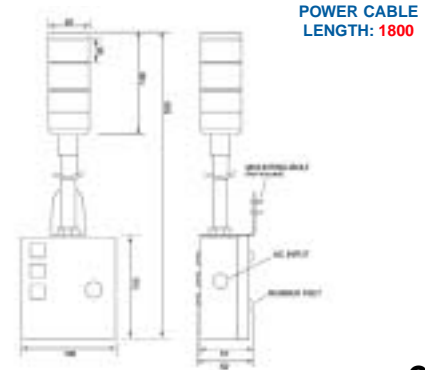

Rotating Warning Lights

Beacons & Cubes

Rotating Warning

MODEL	PAGE
RU	25
PS	25
PEW/PES	26
KP	26
RH-A/RHB-A	27
WH-A/WHB-A	27
WK-A/WKB-A	27
SKH-EA	28
SKH-A/SKHB-A	28

Cube Tower

KUS	29
KJS/KJSB	30
KJ/KJB	30
Wiring Diagrams	31



RU

Mini-Size

RU Rotating Beacon

RUP with Pole and Bracket

MODEL	RATED VOLTAGE	CURRENT DRAW	BULB	No.	ROTATION PER MINUTE	WEIGHT	
						RUBG	RUP/RP
RU/RUP-12	12V DC	0.5A	12V6W	20	120	0.4Kg	0.8Kg
RU/RUP-24	24V DC	0.3A	24V6W	21		0.6Kg	1.0Kg
RU/RUP-120	120V AC	0.1A	12V6W	20			

Dimensions (mm)

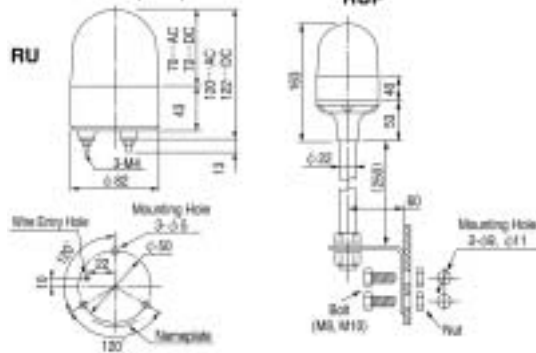

NOTE: See page 31 for wiring diagram.

RU Series Mini-Size Beacon—

The RU Series, mini-size, revolving warning lights. A bright idea for control signals and productivity.

ø82mm Round IP-55* IP-23* Pre-Assembled Pre-Wired



With Optional Rubber Gasket SZ-210

ø82mm

- Colors available: red, yellow, green, and blue.
- *IP Rating: IP-23. RU meets IP-55 with rubber gasket SZ-210.
- Uses incandescent automobile bulb for longer life.
- Lenses: Made of shock and heat resistant polycarbonate resin.
- Integral rotating parabolic reflector makes light visible from a distance.
- RUP includes 300mm steel pole and bracket (SZ-013), nuts & washers.
- Rotates 120 times a minute.
- 12 volt version is only available by special order.

PS

Mini-Size

PS Continuous Light

PSF Flashing Light

MODEL	RATED VOLTAGE	BULB	No.	CURRENT DRAW	WEIGHT
PS/PSF-12	12V AC/DC	12V 10W	9	1A	0.3Kg
PS/PSF-24	24V AC/DC	24V 10W	10	0.5A	
PS/PSF-120	120V AC	140V 10W	15	0.1A	

Dimensions (mm)

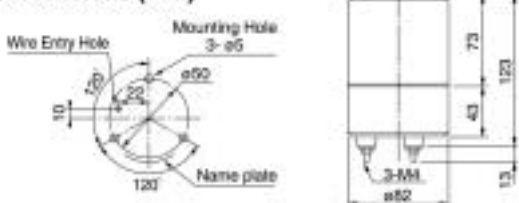

NOTE: See page 31 for wiring diagram.

PS Series Mini-Size Beacon—

The PS/PSF Series, attractively designed mini-size warning lights.

ø82mm Round IP-55* IP-23* Pre-Assembled Pre-Wired



ø82mm

- Colors available: red, yellow, green, and blue.
- *IP Rating: IP-23 (meets IP-55 with rubber gasket SZ-210).
- Rubber gasket available for wash-down application.
- PSF flashes 60 times a minute, using solid state circuitry.
- Lenses are made of heat and shock resistant polycarbonate resin.
- 12 volt version is only available by special order.
- Optional mounting brackets available (SZ-30L, SZ-30T).

With Optional Rubber Gasket SZ-210

PEW/PES

Super Mini Size

PEW Continuous and Flashing

PEW/B with Audible Alarm

PES Continuous and Flashing

MODEL	RATED VOLTAGE	WATTAGE	FREQUENCY OF FLASH	SOUND LEVEL (BUZZER TYPE ONLY)
PEW-24T(B)	24V AC/DC	2.5W	Approx. 180/120/60 times/minute	From 70dB to 85dB (at 1m)
PES-24T	24V AC/DC	1.5W		

Dimensions (mm)

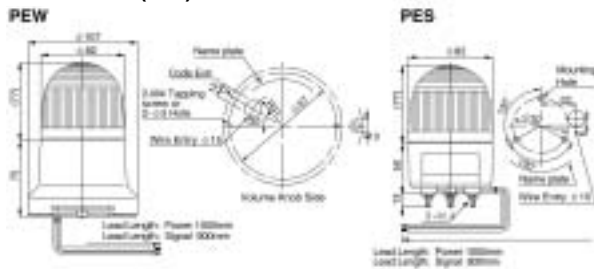

NOTE: See page 31 for wiring diagram.

PEW/PES LED Dome Indicator—

The PEW/PES dome shape provides increased visibility and the LEDs provide years of maintenance-free operation.

ø82mm Round	IP-65* IP-55* IP-23*	Electronic Alarms
85 dB/m	NPN Open-Collector Compatible	Pre-Assembled Pre-Wired

LED Type Light



ø82mm

- Colors available: red, yellow, green, and blue.
- *IP Rating: PEW meets IP-65, PES meets IP-23 (IP-55 w/gasket SZ-210).
- Flashing function available in three different flash rates: 60 fpm, 120 fpm, 180 fpm.
- Dome is visible from top and sides.
- PEW-B features 85dB/m adjustable audible alarm with volume control.
- Low power consumption.
- PES: Optional mounting brackets available (SZ-30L, SZ-30T).

KP-A

Large Size

KP-A Rotating Beacon

MODEL	RATED VOLTAGE	CURRENT DRAW	BULB	ROTATION		WEIGHT
				No.	PER MINUTE	
KP-24A	24V DC	1.5A	24V36W 57	57	160	1.1Kg
KP-120A	120V AC	0.4A	120V40W 60	60	140	1.2Kg

Dimensions (mm)

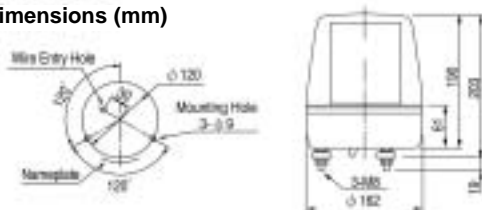

NOTE: See page 31 for wiring diagram.

KP Series Large Size—

The KP Series, large size warning light, is ideal for extreme temperatures or chemically exposed areas. All plastic and rust free.

ø162mm Round	IP-23	Pre-Assembled Pre-Wired
--------------	-------	-------------------------



ø162mm

- Colors available: red, yellow, green & blue.
- Meets IP-23 rating.
- Anti-UV coated body protects from fading, for long term use.
- Stainless steel bolts and nuts protect from rusting.
- Motor operates at extreme low temperatures of -22° F (-30° C).
- Suitable for chemically exposed areas.
- Optional mounting bracket SZ-008 available.

RH-A RHB-A

Mini-Size

RH-AUL Rotating Beacon

RHB-AUL with Audible Alarm

MODEL	RATED VOLTAGE	CURRENT DRAW	BULB	No.	ROTATION PER MINUTE	WEIGHT
RH/RHB-24AUL	24V DC	0.5A	24V10W	10	170	0.4Kg
RH/RHB-120AUL	120V AC	0.1A	12V5W	11	170	0.6Kg

Dimensions (mm)

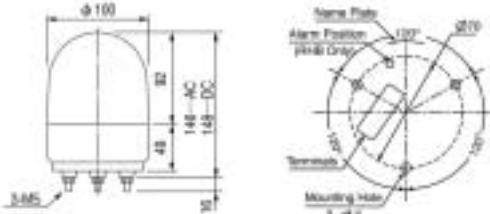

NOTE: See page 31 for wiring diagram.

RH-A/RHB-A Series Mini-Size—

The RH-A/RHB-A Series are mini-size, versatile, durable & compact revolving warning lights. Terminal block allows easy wiring.

ø100mm Round	IP-55	Electronic Alarm: 1	90 dB/m	Pre-Assembled
--------------	-------	---------------------	---------	---------------



Rubber Gasket SZ-200A

ø100mm

- Colors available: red, yellow, green, and blue.
- IP-55 rated, and comes with rubber gasket SZ-200A.
- RHB-A has an integral alarm (hi-pitch tone 90dB at 1m) that sounds with light operation.
- Integral rotating parabolic reflector makes the light visible from long distances.
- Rotates 170 times per minute.
- Optional mounting brackets available (SZ-30L, SZ-30T).

WH-A/WHB-A WK-A/WKB-A

Wall Mount Beacons

WH-A / WK-A Rotating Beacon

WHB-A / WKB-A with Audible Alarm

MODEL	RATED VOLTAGE	BULB	No.	ROTATION PER MINUTE	WEIGHT
WH-12A / WK-12A	12V DC	12V10W	9	170	0.5kg
WH-24A / WK-24A	24V DC	24V10W	10	170	0.5kg
WH-120A / WK-120A	120V AC	12V5W	11	170	0.7kg
WHB-12A / WKB-12A	12V DC	12V10W	9	170	0.5kg
WHB-24A / WKB-24A	24V DC	24V10W	10	170	0.5kg
WHB-120A / WKB-120A	120V AC	12V5W	11	170	0.7kg

Dimensions (mm)

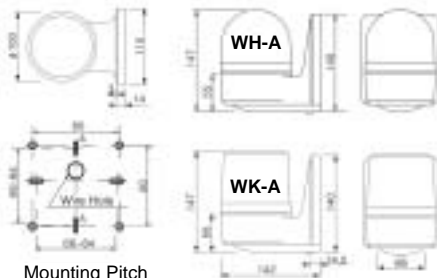

NOTE: See page 31 for wiring diagram.

WH-A and WK-A Series Wall Mount Beacons—

Colorful wall-mounted rotating beacons in 2 dome styles.

ø100mm Round	IP-54* IP-23*	Electronic Alarm: 1	90 dB/m	Pre-Assembled
--------------	------------------	---------------------	---------	---------------



WH-A / WHB-A

WK-A / WKB-A

ø100mm

- Colors available: red, yellow, green, and blue.
- *WHB-A & WKB-A (upright) meet IP-23, WH-A & WK-A meet IP-54.
- Unique beacon with side mount bracket is perfect for vertical, horizontal or inverted mounting positions.
- Electronic buzzer emits sounds intermittently as the light rotates.
- Main body is made of ABS resin and dome is made of shock and heat resistant polycarbonate resin.
- 12V versions are only available by special order.

SKH-EA

Mini-Size

SKH-EA Rotating Beacon

MODEL	RATED VOLTAGE	BULB	No.	ROTATION PER MINUTE	WEIGHT
SKH-12EA	12V DC	12V10W	9	170	0.4Kg
SKH-24EA	24V DC	24V10W	10		
SKH-120EA	120V AC	12V5W	11		

Dimensions (mm)

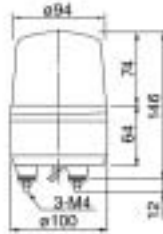

NOTE: See page 31 for wiring diagram.

SKH-EA Series Mini-Size—

The SKH-EA Series are mini-size, low cost, rotating warning lights used for a variety of applications.

ø100mm Round	IP-23	Pre-Assembled Pre-Wired
--------------	-------	-------------------------



12V and 24V only



ø100mm

- Colored acrylic lenses available in red, yellow, green, and blue.
- IP Rating: IP-23.
- Integral rotating parabolic reflector makes the light visible from long distances.
- Uses automobile bulb for longer life.
- Contains a spare bulb inside the housing.
- 12V version is only available by special order.
- Optional mounting brackets available (SZ-30L, SZ-30T).

SKH-A SKHB-A

Standard Size

SKH-A Rotating Beacon

SKHB-A with Audible Alarm

MODEL	RATED VOLTAGE	BULB	No.	ROTATION PER MINUTE	WEIGHT
SKH-101A / SKHB-12A	12V DC	12V10W	9	170	0.4Kg
SKH-102A / SKHB-24A	24V DC	24V10W	10		
SKH-110A / SKHB-100A	100V AC	12V5W	11		
SKH-112A / SKHB-120A	120V AC	12V5W	11	0.6Kg	
SKH-120A / SKHB-220A	220V AC	12V5W	11		

Dimensions (mm)

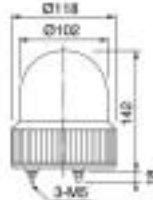

SKH-120A

NOTE: See page 31 for wiring diagram.

SKH-A Series Standard Size—

The SKH-A Series, economic rotating lights, come with one-piece lens and base.

ø118mm Round	IP-23	Electronic Alarm: 1	90 dB/m	Pre-Assembled Pre-Wired
--------------	-------	---------------------	---------	-------------------------



12V and 24V only



ø118mm

- Colored acrylic lenses available in red, yellow, green, and blue.
- Integral rotating parabolic reflector makes the light visible from long distances.
- Uses automobile bulb for longer life.
- SKHB-A has an integral alarm (Hi-pitch tone 90dB/m) that sounds with light operation.
- 12V, 100V and 220V versions are only available by special order.
- IP Rating: IP-23.
- Optional mounting brackets available (SZ-30L, SZ-30T).

PATLITE KUS

KUS Series Multi-Layer Units—

The KUS Series cube tower, with advanced technology, combines two different lights on one unit and has a modular design.

Light Units

KUS-S Incandescent Bulb Type



KUS-EA LED Type



Alarm Unit

KUS-B

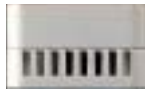

Base Units

KUS Continuous Light

KUS-F Continuous or Flashing Light

LED Type Light



Assembly Required

ø70mm

- *IP Rating: IP-54 (except the KUS-B).
- Lenses: Made of heat & shock resistant polycarbonate resin.
- Light modules can be stacked up to 4 high in any color combination.
- Each light module has a built-in dip switch to control the light, on or off.
- Light units and base unit sold separately.
- Maximum operating capacity of base unit is 21 watts.
- KUS-F flashes 60 times a minute.

KUS-S (Incandescent)					KUS-F (Continuous or Flashing)			
LIGHT UNIT	COLOR	RATED VOLTAGE	WATTAGE	BASE UNIT	RATED VOLTAGE	WATTAGE		
KUS-S-R	RED	24V DC	0.5W	21W MAX	KUS-24	24V AC/DC		
KUS-S-Y	YELLOW				KUS-120	120V AC		
KUS-S-G	GREEN				KUS-24F	24V AC/DC		
KUS-S-B	BLUE				KUS-120F	120V AC		
KUS-S-C	CLEAR							
KUS-B					KUS-EA (LED)			
ALARM UNIT		RATED VOLTAGE	WATTAGE	VOLUME	LIGHT UNIT	COLOR	RATED VOLTAGE	WATTAGE
KUS-B		24V DC	0.5W	70dB/90dB	KUS-EA-R	RED	24V DC	1.2W
					KUS-EA-Y	YELLOW	24V DC	1.2W
					KUS-EA-G	GREEN	24V DC	0.8W

Dimensions (mm)

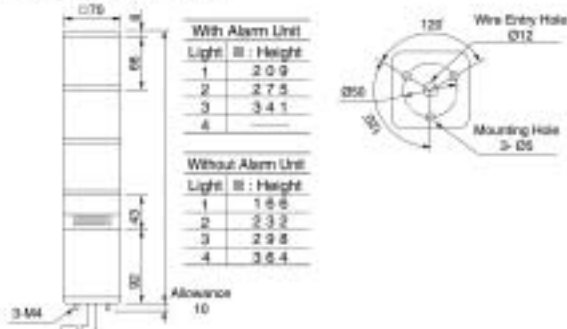

How to Order (Example)

Three LED lights (Red, Yellow, Green) with flashing at input voltage of 24V AC/DC:

- Power Unit: KUS-24F x 1 pc
- Light Module: KUS-EA-R x 1 pc
KUS-EA-Y x 1 pc
KUS-EA-G x 1 pc

NOTE: See page 31 for wiring diagram.

Optional Mounting Brackets (See Pg. 46-47)



KJS/KJSB

Slim Size

KJS Rotating Beacon

KJSB with Audible Alarm

STYLE	MODEL	RATED VOLTAGE	WATTAGE	BULB No.	WEIGHT
1 LIGHT	KJS/KJSB-102	24V DC	12W	24V 15W 10	0.59kg
	KJS/KJSB-112	120V AC	9W	12V 5W 11	0.79kg
2 LIGHT	KJS/KJSB-202	24V DC	24W	24V 15W 10	0.89kg
	KJS/KJSB-212	120V AC	18W	12V 5W 11	1.29kg
3 LIGHT	KJS/KJSB-302	24V DC	36W	24V 15W 10	1.29kg
	KJS/KJSB-312	120V AC	23W	12V 5W 11	1.69kg

KJ/KJB

Standard Size

KJ Rotating Beacon

KJB with Audible Alarm

STYLE	MODEL	RATED VOLTAGE	WATTAGE	BULB No.	WEIGHT
1 LIGHT	KJ/KJB-102	24V DC	12W	24V 10W 10	1.29kg
	KJ/KJB-112	120V AC	7W	12V 5W 11	1.29kg
2 LIGHT	KJ/KJB-202	24V DC	20W	24V 10W 10	1.54kg
	KJ/KJB-212	120V AC	13W	12V 5W 11	2.04kg
3 LIGHT	KJ/KJB-302	24V DC	34W	24V 10W 10	2.04kg
	KJ/KJB-312	120V AC	18W	12V 5W 11	2.54kg
4 LIGHT	KJ/KJB-402	24V DC	40W	24V 10W 10	2.54kg
	KJ/KJB-412	120V AC	20W	12V 5W 11	3.04kg

NOTE: See page 31 for wiring diagrams.

KJS/KJSB Slim Size—

Mirrored parabolic reflector increases visibility on this slim rotating beacon.

ø82mm Square	IP-23	Electronic Alarm: 1	85 dB/m	Pre-Assembled Pre-Wired
--------------	-------	---------------------	---------	-------------------------



ø82mm

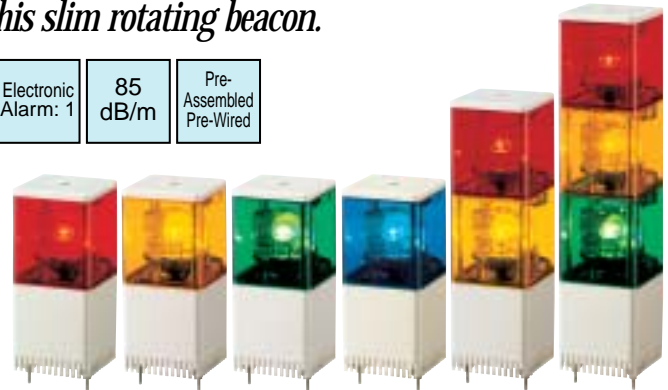

KJ/KJB Series Standard Size—

Larger beacon uses mirrored parabolic reflector for increased visibility.

ø116mm Square	IP-23	Electronic Alarm: 1	90 dB/m	Pre-Assembled Pre-Wired
---------------	-------	---------------------	---------	-------------------------



ø116mm



- Colors available: red, yellow, green, and blue.
- IP Rating: IP-23.
- Integral rotating parabolic reflector makes the light visible from a distance. KJS/KJSB rotates 160 times/minute, KJ/KJB 130 times/minute.
- Lenses can be arranged in any combination desired.
- Each light can be operated separately.
- KJSB and KJB have an integral alarm that sounds intermittently.
- KJS/KJSB: Optional mounting brackets available (SZ-30L, SZ-30T) & SZ-007.

KJ/KJB Dimensions (mm)

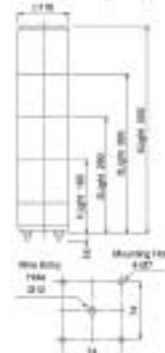

KJS/KJSB Dimensions (mm)



Beacon/Cube Wiring Diagrams

Refer to the wiring diagrams below to determine wiring and wire colors

KX WIRE LENGTH: 250

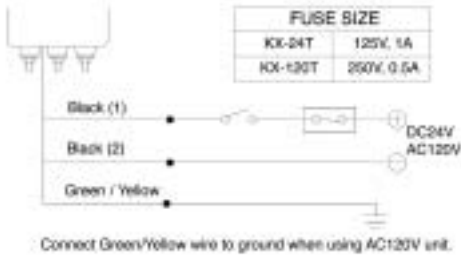

PEW / PES WIRE LENGTH: PEW: 850 PES: 800

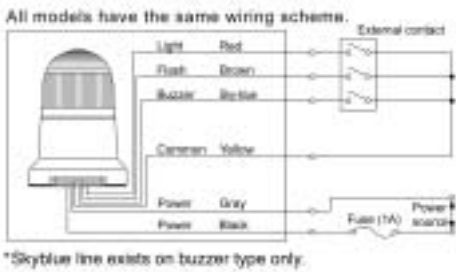

RH-A **RHB-A**

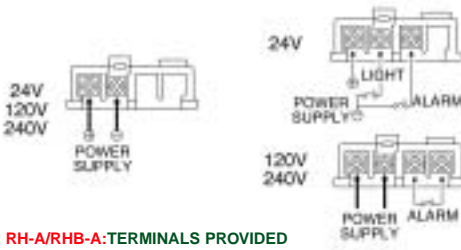

KP WIRE LENGTH: 300

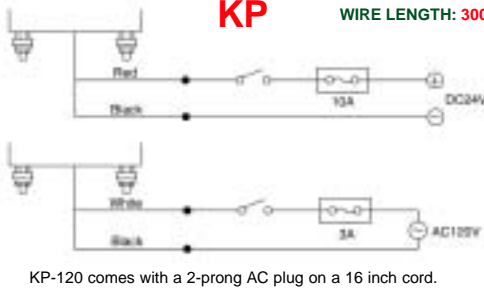

PS / PSF WIRE LENGTH: PS / PSF: 300

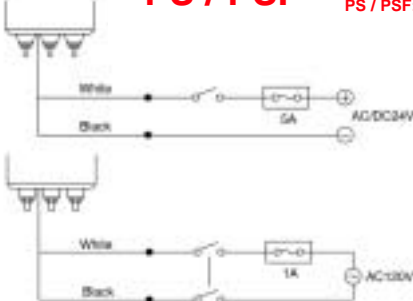

KUS / KUS-F WIRE LENGTH: KUS / KUS-F: 450

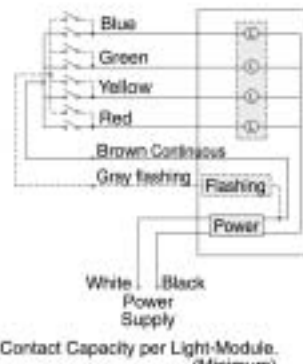

Model	KUS-S	KUS-EA
Current Capacity	1c ≥ 1A	1c ≥ 0.2A
Withstand Voltage	Vc ≥ 45V	

KJ / KJB (24VDC, 12VDC)

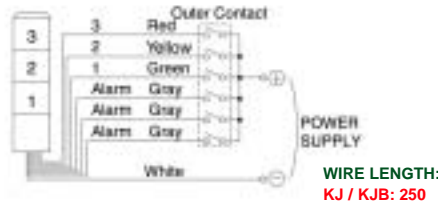

KJ / KJB (120VAC, 220VAC)

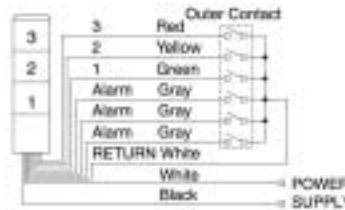

(Note) Gray lead wires do not exist in KJ type.

KJS / KJSB WIRE LENGTH: KJS / KJSB: 250

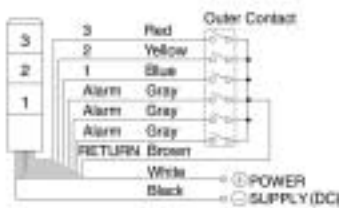

(Note) Gray lead wires do not exist in KJS type.

Open collector NPN transistor

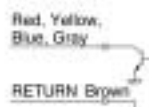

Transistor Capacity (NPN)	
Model	KJS (KJSB)
Current Capacity	Ic ≥ 50mA (Ic ≥ 400mA)
Withstand Voltage	Vc ≥ 45V

SKH-A
SKH-EA
RU / RUP WIRE LENGTH: SKH-A: 300 SKH-EA: 250 RU/RUP: 250

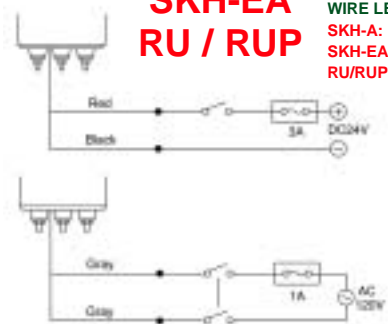

WH-A / WHB-A
WK-A / WKB-A

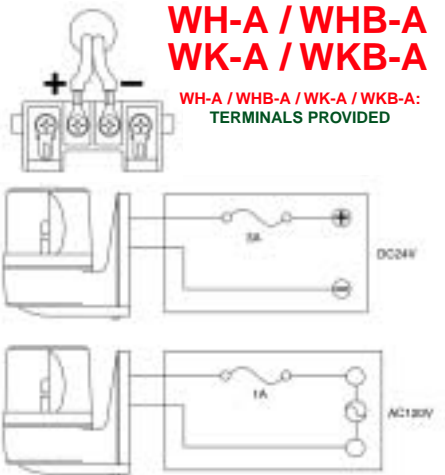

MS / MSF

WIRE LENGTH: 300

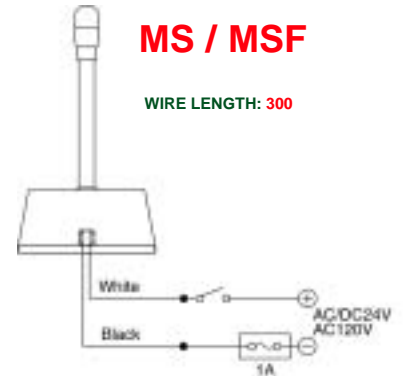

SKHB-A

WIRE LENGTH: SKHB-A: 300

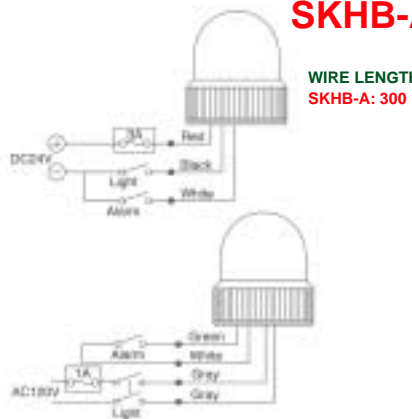

Audible Alarms

Voice Synthesizers

Melody • Chime • Alarm Sound

Voice Synthesizer

MODEL	PAGE
BT	33
PV	34-35
EVB	36
EVW	37
PVW	38
EW/EWS	39
EB-K, EB-L, EMB, ESB, ETB-B	40
BM	41
BA/BC	41

Alarm w/ Rotating Light

RT	42
LGEH	43
KJT	44
Sound Selection	45



PATLITE BT

BT Series Audible Alarm—

The BT Series, with voice, melody, chime and alarm capability, has variable audible control. Includes a compact, but loud speaker.



Alarm

BT-KA Alarm

- BT-KA has 8 distinctive alert sounds.

Chime

BT-L Chime Phone

- BT-L has 6 melodies and 2 chime sounds.
- Choose from F, Q, or S type combinations.

Melody

BT-M Melody Phone

- BT-M has 8 different popular melodies.
- Choose from G, H, or P type combinations.

Voice Synthesizer

BT-V Signal Voice

- BT-V is a programmable voice unit that can replay up to 4 messages with 64 sec. of total program time.
- Produces a clear 64Kbit/sec. sound
- Select voice messages, alarms, chimes and melodies from our command library.
- Custom message programming is also available.

108mm square

- Meets IP-54 rating.
- NPN open collector transistor compatible.
- One-shot contact closure (>100mS) replays selected channel one time only (BT-V).
- Continuous contact closure replays selected channel repeatedly.
- Mounts anywhere with 3 position bracket.
- Moisture proof structure, suitable for moist environments.

Dimensions (mm)

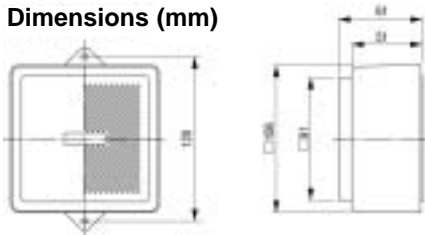

Wiring Diagram

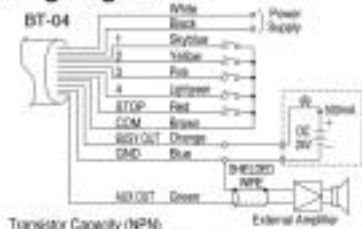

Transistor Capacity (NPN)

Model	BT-04
Current Capacity	Ic: 180mA
Withstand Voltage	Vc: 20V
Signal line current	Ic: 3mA

WIRE LENGTH: 400

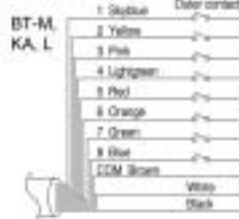

BT has a 3 Position Mounting Bracket:



Install directly to the panel enclosure w/ detachable mount



Permanent tamper-free mount



Flush mount for concealed look

BT-KA: Has 8 distinctive alert sounds.

MODEL	RATED VOLTAGE	POWER CONSUMPTION	VOLUME	WEIGHT
BT-24KA	24V AC/DC	3.5W	Max. 85dB/m	0.43kg
BT-120KA	120V AC	3W	85dB/m	0.5kg

BT-L: 6 melodies and 2 chime sounds. Choose from F, Q, or S types.

MODEL	RATED VOLTAGE	POWER CONSUMPTION	VOLUME	WEIGHT
BT-24L	24V AC/DC	3.5W	Max. 85dB/m	0.43kg
BT-120L	120V AC	3W	85dB/m	0.5kg

BT-M: 8 different popular melodies. Choose from G, H, or P types.

MODEL	RATED VOLTAGE	POWER CONSUMPTION	VOLUME	WEIGHT
BT-24M	24V AC/DC	3.5W	Max. 85dB/m	0.43kg
BT-120M	120V AC	3W	85dB/m	0.5kg

BT-V: Select voice messages.

MODEL	RATED VOLTAGE	POWER CONSUMPTION	VOLUME	WEIGHT
BT-24V	24V AC/DC	7W	Approx. 85dB/m	0.43kg
BT-120V	120V AC	4W	85dB/m	0.5kg

NOTE: 100V AC, 220V AC versions available by special order.

PATLITE PV

PV Series— Programmable Voice/Message Annunciator



Multi-Message Controller

PV Voice Synthesizer



Dimensions (mm)

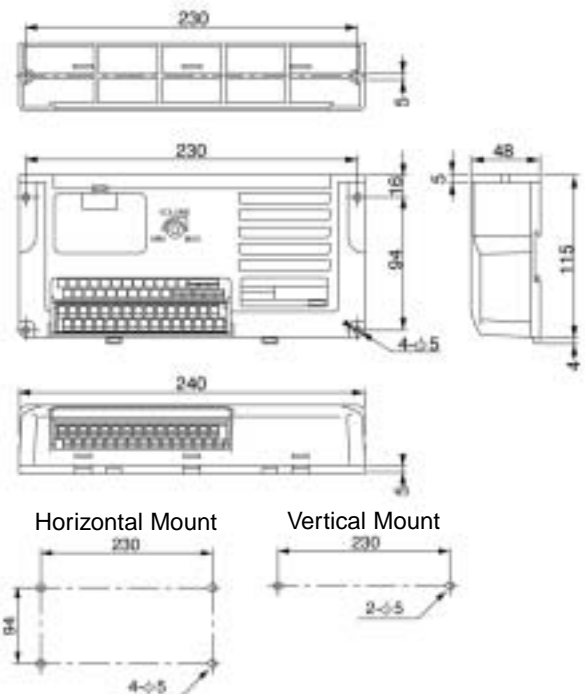

- Up to 32 channel programming with a choice of 64 seconds or 128 seconds of total program time.
- High quality 64Kbit/sec. speech chip creates clear playback.
- 1-bit (1 to 16 channel only with a single contact closure) or 6-bit (1 to 32). Binary input system.
- Maximum output level of 110dB/m with an adjustable volume.
- DIN rail or standalone, vertical or horizontal mounting available.
- Auxiliary output allows connection to external amplifier.
- NPN or PNP open collector transistor compatible.

Programming

Command Library: The Command Library is a compilation of over 3000 pre-recorded industry words and numbers (female voice), and sounds. Each command from the library is in alphabetical order and provides the length of words in seconds to assist in creating the message.

Library Programming: Choose up to 8 words from the Command Library to create your message for each channel. A maximum of 32 channels can be programmed.

Custom Programming: Give us the messages that apply to your particular application, up to 64 seconds or 128 seconds of total program time and up to 32 individual channels.

The PV Series, programmable multi-message controller, is a unique audible controller that allows the flexibility of programming voice messages or any type of sounds to indicate machine status.

Mountings

The PV can be mounted vertically, horizontally or simply mount to DIN rail.



Wiring Diagrams

● Example of wiring by external power supply

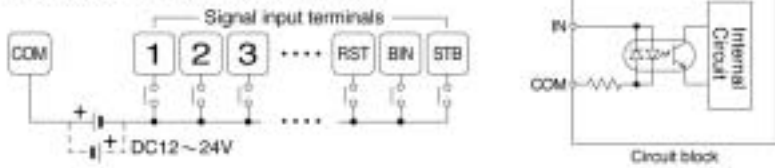

Input contact

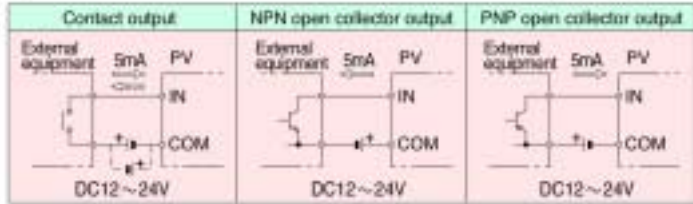

● Example of wiring by internal power supply

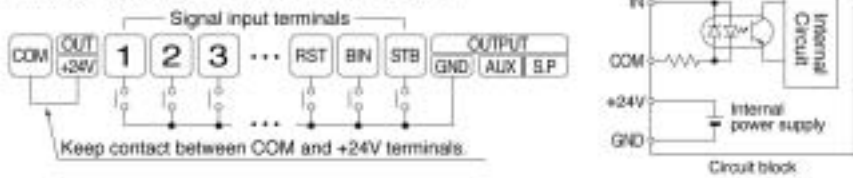

- One-Shot contact closure (≥100ms.) replays selected channel one time only.
- Continuous contact closure replays selected channel repeatedly.

Input contact

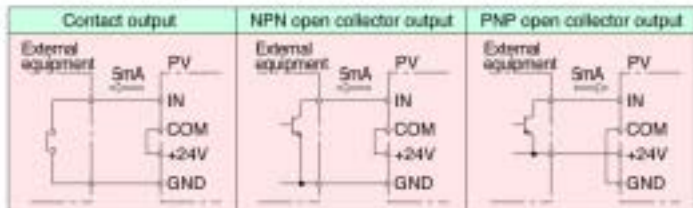

Terminal Block Diagrams

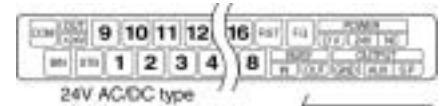

① Power supply

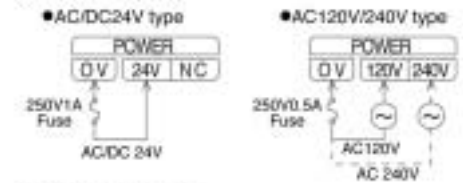

② Speaker output

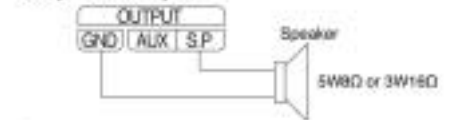

③ AUX output

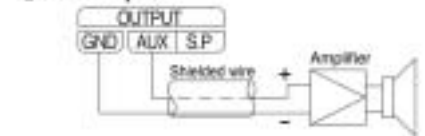

④ BUSY output

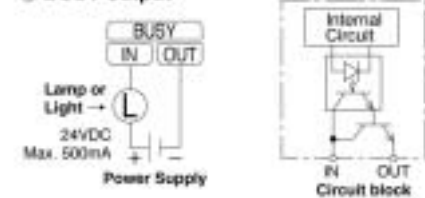

Example of Library Programming by Factory Software

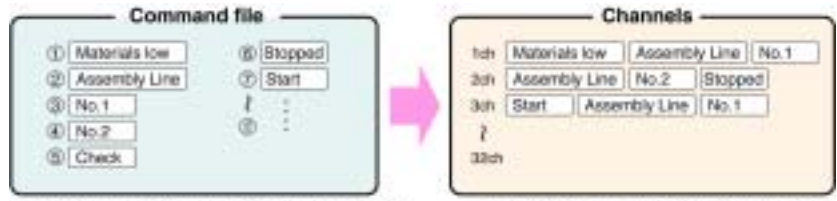

Up to 127 commands with a total of 128 seconds are programmed into the PV's internal library.

Up to 32 channels with a maximum of 8 commands per channel.

Optional Parts



Speaker (5W8Ω): SPW-5E



Speaker (3W16Ω): SPB-3D

MODEL	RATED VOLTAGE	POWER CONSUMPTION		CHANNEL	MAX. OUTPUT	MESSAGE INPUTS	OPERATING TEMPERATURE RANGE	VOLUME	TOTAL PROGRAM TIME	WEIGHT
		ELEMENT MODE	PLAYBACK MODE							
PV-32JEX	24V AC/DC	4W	15W	16 / 1 Bit or 32 / Binary	5W 8Ω	16 / 1 Bit or 6 / Binary	-10°C ~ +55°C (Less than 85% RH)	Approx. 110dB with optional speaker (SPW-5E)	64 or 128 sec.	0.46kg
PV-32TEX	120V AC	6W	15W							0.61kg

PATLITE EVB

Self-Recordable Voice Annunciator

EVB-04 Voice Synthesizer

MODEL	RATED VOLTAGE	CHANNEL	MSG MESSAGE TIME	WATTAGE	OPERATING TEMPERATURE RANGE	VOLUME	WEIGHT
EVB-04JF	24V AC/DC	4	60 SEC.	9W	-10°C~+55°C	Max. 90dB/m	0.8Kg
EVB-04TF	120V 220V AC						1.0Kg

KF/100-220V versions are available by special order.

Dimensions (mm)

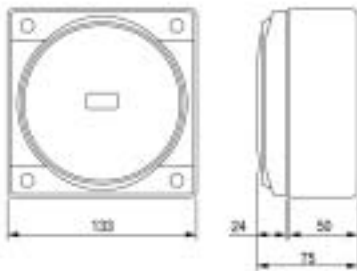

Wiring Diagram

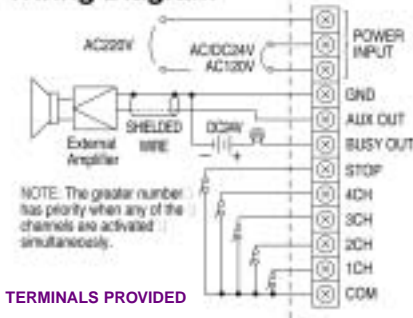

TERMINALS PROVIDED

Mounting Pitch

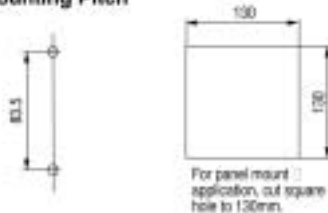

EVB-D Series Self-Recordable Annunciator—

The EVB Series is a box design with easy self-recording. Record up to 4 messages with 60 seconds total recording time.



133mm square

- Program in the field with optional microphone (MC-EV).
- High quality voice synthesizer replays up to 4 messages with 60 seconds of total program time.
- Maximum output level of 90dB/m with an adjustable volume.
- NPN open collector transistor compatible.
- Two mounting options: wall mount or panel mount.
- Auxiliary output allows connection to external amplifier.
- Easy recording and playback.
- NPN open collector permits direct connection to a PLC.
- Using BUSY terminals, a revolving light or display can be operated during voice output.

PATLITE EVW

Recording and Playback

EVW-04 Voice Synthesizer

MODEL	RATED VOLTAGE	POWER CONSUMPTION	VOLUME	WEIGHT
EVW-04JF	120/24V AC/DC	12W	105dB (at 1m)	1.2kg
EVW-04KF	100V AC	18W		1.4kg
EVW-04QF	220V AC	18W		1.4kg

220V version is only available by special order.

EVW Series Recording and Playback—

The EVW Series has easy recording with attached microphone. Record up to 4 messages with 60 seconds total recording time.



Microphone (Optional)

Dimensions (mm)

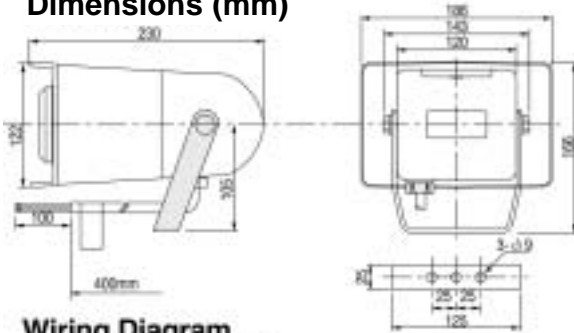

Wiring Diagram

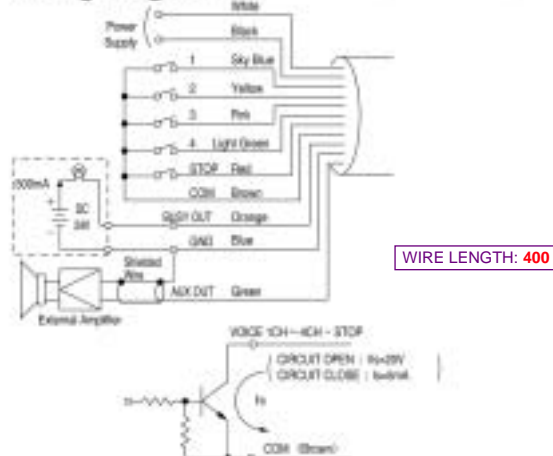

- Easy recording and playback with optional microphone (MC-EV).
- Meets IP-53 for washdown requirements.
- Anti-corrosive stainless steel bracket.
- Clear sound with original wide horn style.
- High quality voice synthesizer replays up to 4 messages with 60 seconds of total program time.
- High volume, maximum 105dB at 1m, adjustable.
- NPN open collector permits direct connection to a PLC.
- Auxiliary output allows connection to external amplifier.

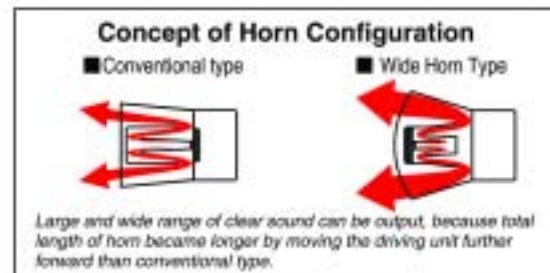

PATLITE PVW

Playback Only

PVW-04 / 15 Voice Synthesizer

MODEL	RATED VOLTAGE	POWER CONSUMPTION	VOLUME	WEIGHT
PVW-04JF	12/24V AC/DC	12W	Approx. 105dB (at 1m)	1.3kg
PVW-04DF	48V DC	10W		1.3kg
PVW-04KF	100V AC	18W		1.4kg
PVW-04QF	220V AC	18W		1.4kg
PVW-15JF	12/24V AC/DC	12W	Approx. 105dB (at 1m)	1.3kg
PVW-15DF	48V DC	10W		1.3kg
PVW-15KF	100V AC	18W		1.4kg
PVW-15QF	220V AC	18W		1.4kg

48V and 220V versions only available by special order.

Dimensions (mm)

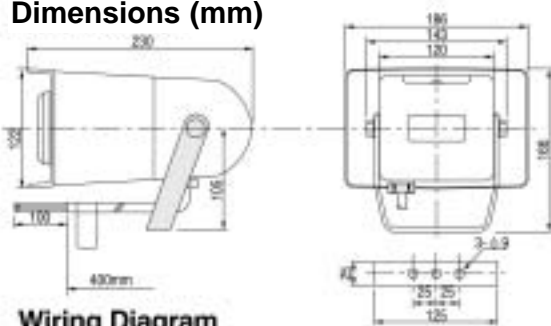

Wiring Diagram

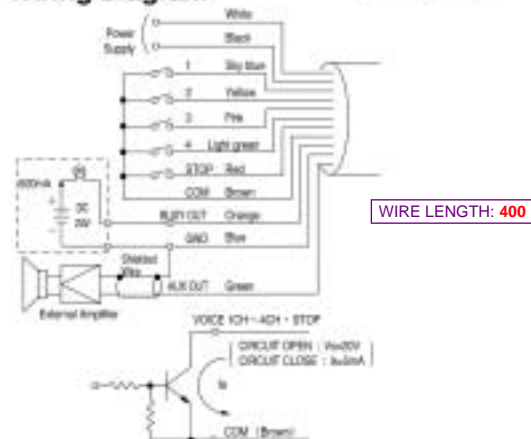

PVW Series Playback Only—

The PVW Series is perfect for use in noisy environments. They can replay messages up to 64 seconds long.



- Meets IP-53.
- Anti-corrosive stainless steel bracket.
- Clear sound with original wide horn style.
- High volume, maximum 105dB at 1m.
- NPN open collector permits direct connection to a PLC.
- Internal adjustable volume control to match a range of environments.
- PVW-04: Up to 4 messages for a total of 64 seconds can be set.
- PVW-15: Up to 15 messages for a total of 64 seconds can be set.
- Clear sound from voice synthesizers is given by the high bit rate (ADPCM 64 bit/s).
- Available with optional extension amplifier (PVA-30=30W) connected to AUX OUT.
- Replaying message may be stopped by "stop" input.
- The playback start signal is input from a switch on an external device. If the signal is received once, the message will be played once; and if the signal is continued, the message will be repeated.

PATLITE EW/EWS

EW/EWS Series Horn Style Alarm—

The EW/EWS Series with large volume, is perfect for use in noisy factories.

Horn Style Alarm

EW-KA / EWS-KA	Alarm
EW-L / EWS-L	Chime Choose from Sound Types: F, Q, S
EW-M / EWS-M	Melody Choose from Sound Types: G, H, P



Dimensions (mm)

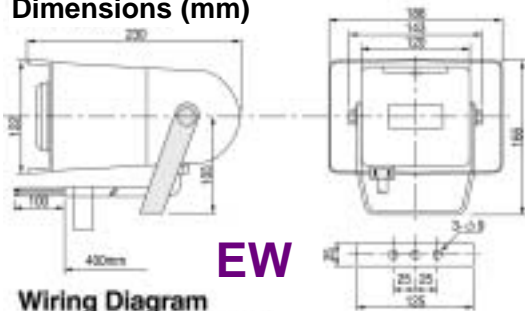

EW

Wiring Diagram

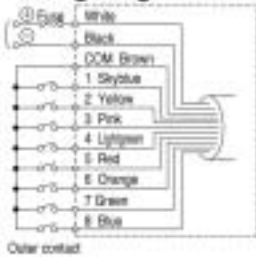

Fuse Capacity

Voltage	Fuse
12V	1A
24V	0.5A
48V	0.3A
100V	0.3A
220V	0.15A

WIRE LENGTH: 400

- Meets IP-65.
- NPN open collector permits direct connection to a PLC.
- EW-K & EWS-K: has 8 distinctive alert sounds.
- EW-L & EWS-L: has 6 melodies and 2 chime sounds.
- EW-M & EWS-M: has 8 different world familiar melodies.
- Integral volume control.
- Universal mounting bracket permits easy installation in any location.
- LSI digital synthesizer assures continuous high quality sound reproduction for the life of the system.
- EWS: Select one sound by dip switch from 8 pre-installed sounds.

Dimensions (mm)

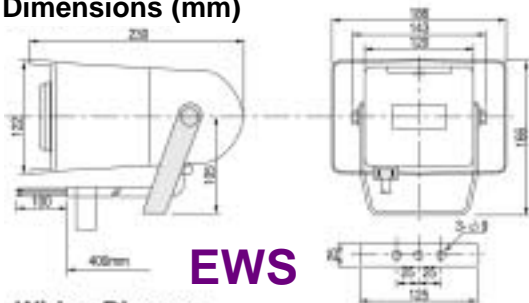

EWS

Wiring Diagram



Fuse Capacity

Voltage	Fuse
12V	1A
24V	0.5A
48V	0.3A
100V	0.3A
220V	0.15A

Sound selection is made by dip switch selection (Caution) polarity of power supply in case of DC.

WIRE LENGTH: 400

MODEL	RATED VOLTAGE	POWER CONSUMPTION	VOLUME	WEIGHT
EW/EWS-24M	12/24V AC/DC	8W	Max. 105dB (at 1m)	1.2kg
EW/EWS-48M	48V DC	10W		1.2kg
EW/EWS-100M	100V AC	12W		1.4kg
EW/EWS-220M	220V AC	13W		1.4kg
EW/EWS-24L	12/24V AC/DC	8W		1.2kg
EW/EWS-48L	48V DC	10W		1.2kg
EW/EWS-100L	100V AC	12W		1.4kg
EW/EWS-200L	200V AC	13W		1.4kg
EW/EWS-24K	12/24V AC/DC	8W		1.2kg
EW/EWS-48K	48V DC	10W		1.2kg
EW/EWS-100K	100V AC	12W		1.4kg
EW/EWS-200K	200V AC	13W		1.4kg

48V, 200V and 220V versions only available by special order.

NOTE: See Page 45 for the Sound Type Selection Chart.

EB-K, EB-L EMB, ESB ETB-B

EB, EMB, ESB & ETB Series Box Style Alarms, Wall or Panel Mounts—

The EB, EMB, ESB and ETB Series have a simple box design that fits with various types of machinery.

Box Style Alarm

EB-K	8 Output	Alarm
EB-L	8 Output	Chime Choose from Sound Types: F, Q, S
EMB	8 Output	Melody Choose from Sound Types: G, H, P
ESB	1 Output	Alarm
ETB-B	4 Output	Alarm



Dimensions (mm)

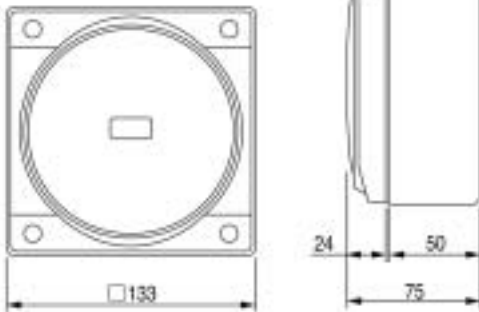

133mm square

- LSI digital synthesizer assures continuous high quality sound reproduction for the life of the system.
- Two mounting options: wall or panel mount.
- Units are operated by a continuous contact closure and replay selected channel repeatedly.
- **EB-K** has 8 distinctive alert sounds.
- **EB-L** has 6 melodies and 2 chimes.
- **EMB** has 8 different popular melodies.
- **ESB** has 1 output, alarm.
- **ETB-B** has 4 different alarm sounds.

Wiring Diagram

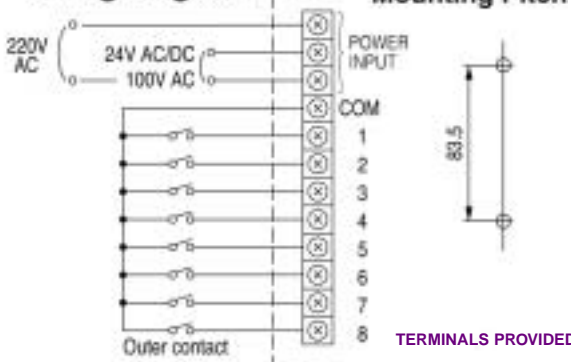

ESB has 1 output.

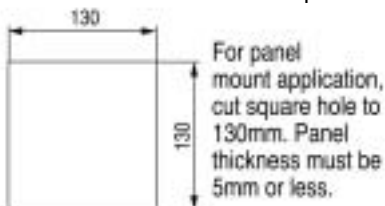

MODEL	RATED VOLTAGE	POWER CONSUMPTION	VOLUME	WEIGHT
EB-24KA	24V AC/DC	6W	Max. 95dB/m	0.7kg
EB-120KA	120V AC	7W		0.9kg
EB-24L	24V AC/DC	6W	Max. 90dB/m	0.7kg
EB-120L	120V AC	7W		0.9kg
EMB-24	24V AC/DC	6W	Max. 93dB/m	0.7kg
EMB-120	120V AC	7W		0.9kg
ESB-24P	24V AC/DC	4W	Max. 93dB/m	0.7kg
ESB-120P	120V AC	5W		0.9kg
ETB-24B	24V AC/DC	6W	Max. 95dB/m	0.7kg
ETB-120B	120V AC	7W		0.9kg

NOTE: See Page 45 for the Sound Type Selection Chart.

BM

Compact Panel Mount Alarm

BM

Signal Phone



Dimensions (mm)

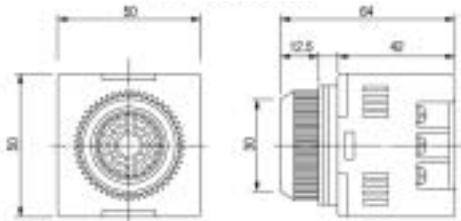

Wiring Diagram

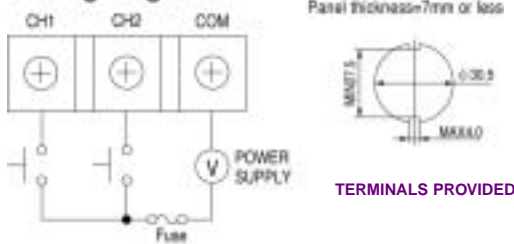

BM Compact Panel Mount Alarm—

The BM Series, extremely small design complete with two buzzer sounds. Ideal for use with control panels or production equipment.

IP-34	90 dB/m	Open-Collector	Pre-Assembled
-------	---------	----------------	---------------

50mm square (ø30mm)

- Ultra compact size.
- Provided with 2 selectable, distinctive alert sounds.
- High volume in a compact unit (volume is not adjustable).
- NPN or PNP open collector transistor compatible (24 V type only).
- Continuous contact closure replays selected channel repeatedly.
- Channel 1 has priority.



MODEL	RATED VOLTAGE	POWER CONSUMPTION	VOLUME
BM-202H	24V AC/DC	0.4W	85dB/m (Approx.)
BM-212H	120V AC	2.5W	90dB/m (Approx.)

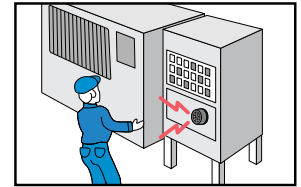

BA/BC

Compact Panel Mount Alarm

BA-K

Alarm Four
Choose from Sound Types: A, D

BC-L

Chime Phone
Choose from Sound Types:
F, G, H, J, L, P, Q, S, W

Dimensions (mm)

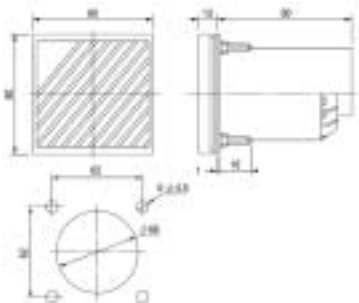

Wiring Diagram

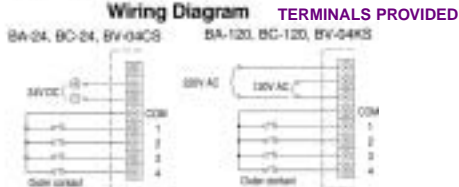

BA/BC Compact Panel Mount Alarm—

The BA/BC Series, dust and waterproof design (IP-54) allows trouble-free use in harsh environments.

IP-65	85 dB/m	Open-Collector	Pre-Assembled
-------	---------	----------------	---------------

80mm square

- IP Rating: IP-65.
- BA has 4 distinctive alert alarms, BC has 2 melodies and 2 chimes.
- Integral volume control.
- NPN open collector transistor compatible, PNP compatible by special order only.
- Utilizes a mylar cone speaker for dust resistance.



MODEL	RATED VOLTAGE	POWER CONSUMPTION	VOLUME
BA-24K	24V DC	5W	Max. 85dB/m
BA-120K	120V AC	4.5W	Max. 83dB/m
BC-24L	24V DC	5W	Max. 83dB/m
BC-120L	120V DC	4.5W	Max. 83dB/m

NOTE: See Page 45 for the Sound Type Selection Chart.

PATLITE RT

RT Series Alarm with Rotating Light—
The RT Series is a large horn and rotating light combination for increased plant floor coverage.

Alarm with Rotating Light

RT-KA	Alarm Comes with 8 alarm sounds
RT-L	Chime: Comes with 6 melodies and 2 chimes Choose from Sound Types: F, Q, S
RT-VS	Voice Synthesizer Can replay 4 messages with 64 sec. of total program time

TYPE OF MODEL	MODEL	RATED VOLTAGE	BULB (318BA155)	VOLUME	WEIGHT
Voice Synthesizer	RT-24VS	24V AC/DC	24V20W	6 Max.	2.0kg
Chime Phone	RT-120VS	120V AC	12V15W	5 100dB/m	2.3kg
Alarm Sound	RT-24KA	24V AC/DC	24V20W	6 Max.	2.0kg
	RT-120KA	120V AC	12V15W	5 105dB/m	2.3kg



Dimensions (mm)

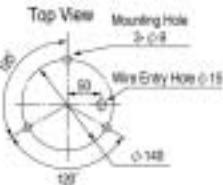
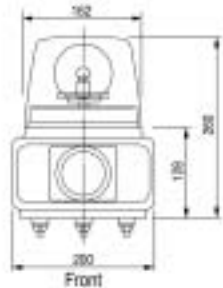

Wiring Diagram

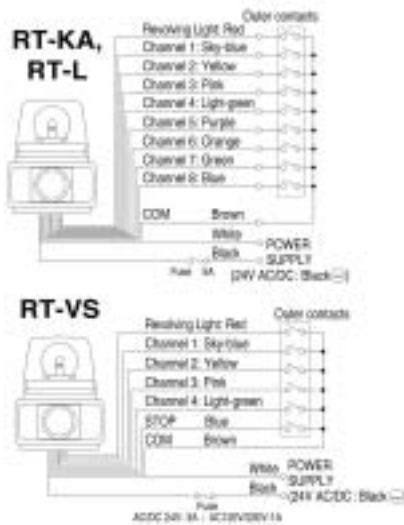

WIRE LENGTH: 250

NOTE: See Page 45 for the Sound Type Selection Chart.

ø162mm Dome

- Colors available: red, yellow, green, and blue.
- IP Rating: IP-23.
- Adjustable volume control: Max. 105dB/m* (*Max. 100dB/m for RT-VS).
- Lenses are made of acrylic resin.
- NPN open collector transistor compatible.
- RT-VS requires message programming from the command library (free) or custom messages (optional).
- Clear, distortion-free playback.
- Eight Outputs: RT-L & RT-K.
- Four Outputs: RT-VS.
- Optional mounting bracket: SZ-008.
- 220V version is available by special order only.
- IP-54 rated version by special order only.

PATLITE LGEH

Horn/Signal Tower

- | | |
|-----------------|--|
| LGEH-FKA | Alarm
Comes with 8 alarm sounds |
| LGEH-FL | Chime: Comes with 6 melodies and 2 chimes
Choose from Sound Types: F, Q, S |
| LGEH-FM | Melody: Comes with 8 melodies
Choose from Sound Types: G, H, P |
| LGEH-FV | Voice Synthesizer
Can replay 4 messages with 64 sec. of total program time |

LGEH Series Indicating Light w/Horn —

The LGEH Series is a large horn and signal tower combination that supplies greater sound and visibility.



ø100mm

- Colors available: red, yellow, green, blue, clear.
- IP Rating: IP-53.
- Stacking: 1 to 4 lights.
- LED light is effectively diffused to create a full and brilliant color with a triple reflection system.
- Large diameter signal tower is visible from great distances (lens dimension is 100mm x 50mm).
- Lenses are made of heat & shock resistant polycarbonate resin.
- LSI digital voice synthesizer assures continuous high quality sound reproduction for the life of the system.
- Maximum output level of 102dB/m with an adjustable volume.
- Auxiliary output allows connection to an external amplifier.
- 220V version is only available by special order.

Dimensions (mm)

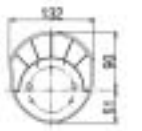
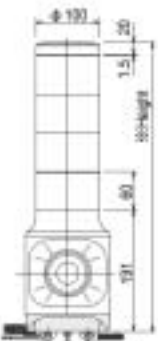

Height (mm)
1 Light : 274
2 Lights : 336
3 Lights : 397
4 Lights : 459

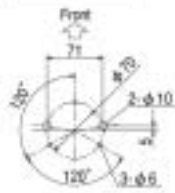

Wiring Diagram in Direct Power Connection

FM, FKA, FL type

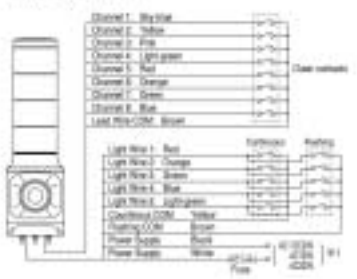

FV type



Wiring Diagram in Direct Power Connection

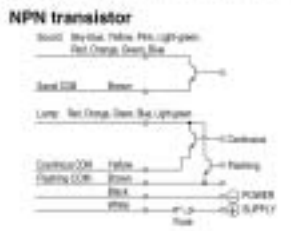

WIRE LENGTH: 300

NOTE: See Page 45 for the Sound Type Selection Chart.

TYPE OF LIGHT	MODEL	RATED VOLTAGE	LIGHT POWER CONSUMPTION
1 LIGHT	LGEH-102F	24V AC/DC	2W
	LGEH-112F	120V AC	3W
	LGEH-120F	220V AC	3W
2 LIGHTS	LGEH-202F	24V AC/DC	4W
	LGEH-212F	120V AC	6W
	LGEH-220F	220V AC	6W
3 LIGHTS	LGEH-302F	24V AC/DC	6W
	LGEH-312F	120V AC	9W
	LGEH-320F	220V AC	9W
4 LIGHTS	LGEH-402F	24V AC/DC	8W
	LGEH-412F	120V AC	12W
	LGEH-420F	220V AC	12W

PATLITE KJT

KJT Series Alarm with Rotating Light—
The KJT Series combines highly visible multi-stack rotating lights with sound. Gives doubly effective warning signals.

Alarm with Rotating Light

KJT-KA Alarm Eight

KJT-L Chime Phone
 Choose from Sound Types: F, Q, S

TYPE OF MODEL	MODEL	STACKED LIGHT			RATED VOLTAGE	BULB (S/BA15S)	No.	VOLUME
		1 LIGHT	2 LIGHT	3 LIGHT				
Chime Phone	KJT-L	102	202	302	24V AC/DC	24V10W	10	Max.
		112	212	312	120V AC	12V5W	11	90dB/m
Alarm Eight	KJT-KA	102	202	302	24V AC/DC	24V10W	10	Max.
		112	212	312	120V AC	12V5W	11	90dB/m

Note: 100V AC, 220V AC versions available by special order.

WEIGHT	RATED VOLTAGE	1 LIGHT	2 LIGHT	3 LIGHT
		24V AC/DC	1.3kg	2.0kg
	120V AC	1.6kg	2.5kg	3.0kg

Dimensions (mm)

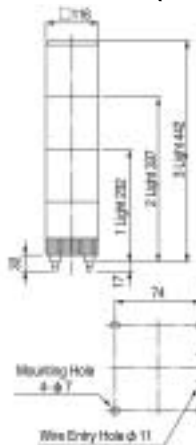

Wiring Diagram

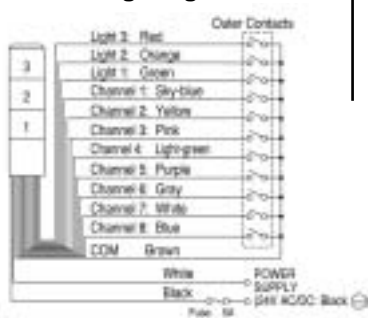

WIRE LENGTH:
 Power Wire: 270
 Signal Wire: 380



ø116mm

- Colors available: red, yellow, green, and blue.
- IP Rating: IP-23.
- Integral alarm control.
- Each alarm and each light in the tower can be operated separately or together.
- Lenses are made of acrylic resin.
- NPN open collector transistor compatible.
- KJT-KA has 8 distinctive alert sounds.
- KJT-L has 6 melodies and 2 chime sounds.
- Optional mounting bracket: SZ-008.

NOTE: See Page 45 for the Sound Type Selection Chart.

Sound List Selection Charts / Audible Products

PATLITE offers a variety of audible products with: ALARMS (such as KA or KD), MELODIES/CHIMES (such as LF or LQ) and MELODIES (such as MG or MH). For ordering, choose the Product and the Alarm type in the tables below. (Example: **EMB H-Type**)

Model	ESB	ETB
Ch		
1	Stutter (1 sound)	Stutter
2		Chime
3		Beep
4		Yelp

Model	BA	
Ch	KA-Type	KD-Type
1	Beep	Rapid Hi-Lo
2	Stutter	Melody Chime
3	Bell	Synthesized Piano
4	Yelp	Synthesized Bell

Model	BT / EW / EWS / LGEH-F						
Ch	KA-Type	LF-Type	LQ-Type	LS-Type	MG-Type	MH-Type	MP-Type
1	Beep	Fur Elise	Mary Had a Little Lamb	Amaryllis	Runner	Happy Birthday	She Wore a Yellow Ribbon
2	Stutter	Maiden's Prayer	Camptown Races	Symphony No. 40	I Want to Take Care of You	Mickey Mouse Club March	My Darling Clementine
3	Bell	Minuet	Cuckoo	Silent Lakeside	Listening to Olivia	It's a Small World	The Yellow Rose of Texas
4	Yelp	Annie Laurie	Blacksmith in the Village	Mountain Musician	September	Forest Bear	Yankee Doodle
5	Rapid Hi-Lo	London Bridge is Falling Down	On the Avignon Bridge	Romance De Amour	Saturday Lovers	Cha Cha Toy	When the Saints Go Marching In
6	Melody Chime	Holdiridia	Ob-La-Di, Ob-La-Da	Petrouchka	Autumn	Is There a Kid Like This?	Londonderry Air
7	Synthesized Piano	Chime			Surf Heaven, Ski Heaven	Schubert's Lullaby	Havah Nagilah
8	Synthesized Bell	Call Sign			Color / White Blend	Rudolf the Red-Nosed Reindeer	Jamaica Farewell

Model	EB / KJT / RT			
Ch	KA-Type	LF-Type	LQ-Type	LS-Type
1	Beep	Fur Elise	Mary Had a Little Lamb	Amaryllis
2	Stutter	Maiden's Prayer	Camptown Races	Symphony No. 40
3	Bell	Minuet	Cuckoo	Silent Lakeside
4	Yelp	Annie Laurie	Blacksmith in the Village	Mountain Musician
5	Rapid Hi-Lo	London Bridge is Falling Down	On the Avignon Bridge	Romance De Amour
6	Melody Chime	Holdiridia	Ob-La-Di, Ob-La-Da	Petrouchka
7	Synthesized Piano	Chime		
8	Synthesized Bell	Call Sign		

Model	BC								
Ch	LF-Type	LG-Type	LH-Type	LJ-Type	LL-Type	LP-Type	LQ-Type	LS-Type	LW-Type
1	Fur Elise	Romance De Amour	Minuet	Cuckoo	London Bridge is Falling Down	Silent Lakeside	Mary Had a Little Lamb	Amaryllis	On the Avignon Bridge
2	Maiden's Prayer	Petrouchka	Annie Laurie	Blacksmith in the Village	Holdiridia	Mountain Musician	Camptown Races	Symphony No. 40	Ob-La-Di, Ob-La-Da
3	Chime								
4	Call Sign								

Model	EMB		
Ch	G-Type	H-Type	P-Type
1	Runner	Happy Birthday	She Wore a Yellow Ribbon
2	I Want to Take Care of You	Mickey Mouse Club March	My Darling Clementine
3	Listening to Olivia	It's a Small World	The Yellow Rose of Texas
4	September	Forest Bear	Yankee Doodle
5	Saturday Lovers	Cha Cha Toy	When the Saints Go Marching In
6	Autumn	Is There a Kid Like This?	Londonderry Air
7	Surf Heaven, Ski Heaven	Schubert's Lullaby	Havah Nagilah
8	Color / White Blend	Rudolf the Red-Nosed Reindeer	Jamaica Farewell

Optional Parts

Mounting Poles & Brackets (mm)



PART No.	MODEL	PART No.	MODEL	PART No.	MODEL	PART No.	MODEL
SZ-70L	LME-W	SZ-60L	LEL	SZ-50L	LHE-A, LU7	SZ-40L	KUS
SZ-80L	LCE-W	SZ-60T	LES-AW	SZ-50T		SZ-30L	KJS, KX, LGE, PES, PS, SKH-A, SKH-EA, RH-A, RU
						SZ-30T	

Mounting Brackets (mm)

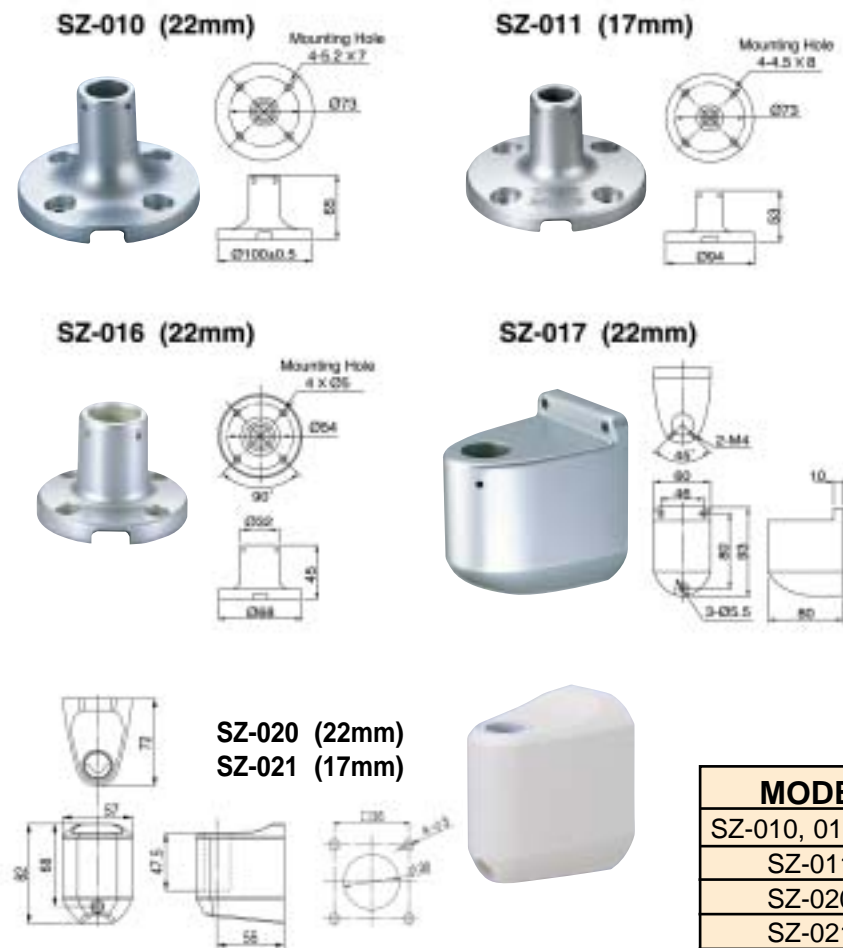

Rubber Gaskets (mm)

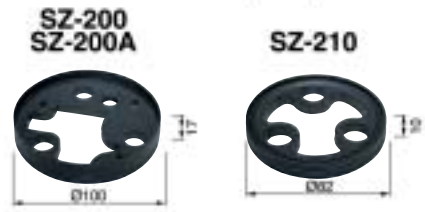

MODEL	PRODUCT
SZ-200A	KX-T, RHB-A, SKH-EA
SZ-210	PES, PS, PSF, RU



MODEL	PRODUCT
SZ-010, 016, 017	LME, LME-L, RUP, SE-T, ST, STPB
SZ-011	LCE, LE-P, LES-A
SZ-020	LME
SZ-021	LCE, LE-P, LES-A
SZ-903	LCE, LE-P, LES-A, ME, MEL, MES, MT
SZ-904	LME-L, RUP, SE-T, ST, STPB

Mounting Brackets (mm)

SZ-012

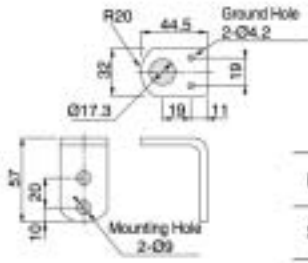

(Pole is not included)

MODEL	PRODUCT
SZ-012	LCE, LE-P, LES-A

SZ-013

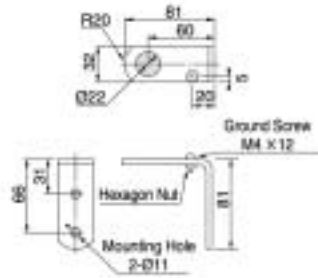

(Pole is not included)

MODEL	PRODUCT
SZ-013	LME-L, ME, MEL, MES, MT, RUP, SE-T, ST, STPB

SZ-007

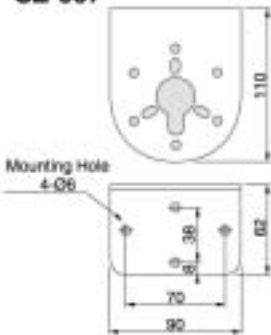

MODEL	PRODUCT
SZ-007	KJS, KJS, KX, LGE, LHE-A, LME, LU PES, PS, RH-A, RU, SKH-A, SKH-EA

SZ-008

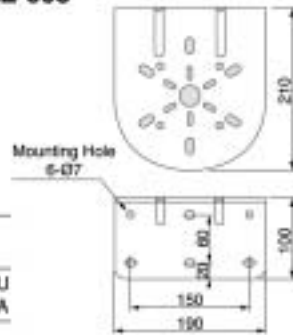

MODEL	PRODUCT
SZ-008	KJ, K/JT, KP, RT

Replacement Bulbs

TYPE	BULB No.	WATTAGE	PART No.	TYPE	BULB No.	WATTAGE	PART No.			
G18/BA15S	5	12V15W	LMP-0071	T20/BA15D	50	28V20W	LMP-0328			
	6	24V20W	LMP-0072		52	140V20W	LMP-0314			
	9	12V10W	LMP-0099		53	250V20W	LMP-0325			
	10	24V10W	LMP-0100	RP35/BA15S	56	12V35W	LMP-0004			
	11	12V5W	LMP-0093		57	24V35W	LMP-0005			
T20/E12	7	12V10W	LMP-0097	RP35/BA15D	60	120V40W	LMP-0092			
	8	12V5W	LMP-0091		61	240V30W	LMP-0062			
	12	30V10W	LMP-0098		62	48V35W	LMP-0008			
	13	24V5W	LMP-0090		63	220V30W	LMP-0007			
	14	110V10W	LMP-0094	T10/BA15S	70	12V55W	LMP-0079			
	15	140V10W	LMP-0086		71	24V70W	LMP-0080			
	16	140V5W	LMP-0061	LED-Lamps						
	17	110V15W	LMP-0119	TYPE	COLOR	VOLTAGE	PART NO.			
	18	220V15W	LMP-0120	27, 43.7	ST/STPB CS	RED	24V	DE24E-R		
19	240V10W	LMP-0053	YELLOW			24V	DE24E-Y			
G14/BA9S	20	12V6W	LMP-0116			27, 47.4	E12	GREEN	24V	DE24E-G
	21	24V6W	LMP-0117					BLUE	24V	DE24E-B
T10/E10	22	140V3W	LMP-0121					LGSM	BA15D	CLEAR
	23	140V5W	LMP-0125	RED	24V					DE24D-R
	24	110V5W	LMP-0110	YELLOW	24V					DE24D-Y
	25	240V5W	LMP-0112	GREEN	24V	DE24D-G				
	26	240V5W	LMP-0112	BLUE	24V	DE24D-B				
	27	12V0.11A	LMP-0113	CLEAR	24V	DE24D-C				
	28	24V0.11A	LMP-0108							
T20/BA15D	39	28V11W	LMP-0228							
	40	110V12W	LMP-0211							
	41	250V11W	LMP-0225							
	49	140V13W	LMP-0214							



Manufacturing Plant, Japan



Head Office, Japan



Technical Center, Japan



PATLITE (U.S.A.) Corp., California



PATLITE (U.S.A.) Corp., Illinois

PATLITE (U.S.A.) Corporation:

Website: www.patlite.com

E-mail: sales@patlite.com

3860 Del Amo Blvd., Suite 401, Torrance, CA 90503

Tel: (310) 214-3222 • Fax: (310) 214-9999

500 East Remington Rd., Suite 107, Schaumburg, IL 60173

Tel: (847) 781-6999 • Fax: (847) 781-6996

PATLITE Corporation (Japan):

Website: www.patlite.co.jp/int/

2-58 Wakabayashi-cho, Yao-Shi, Osaka 581-0038 Japan

Tel: (81) 729-48-3211 • Fax: (81) 729-48-5533

Specifications are subject to change without notice.

ISO14001 / ISO9001 Certified

(PATLITE Corporation - Head Office / Sanda Plant / Techno Center)



PATLITE