



Designed for those applications requiring higher amperage and voltage handling capability in a compact design. Available with American Standard or Metric Threaded Stud terminals, or Saddle Clamp screw terminals. Available with optional mid-trip handle style actuator, solid color rocker actuators and Visi-rocker two color actuators. Visi-rocker can be specified to indicate either the ON or TRIPPED/OFF mode. Rockerguard and Push-To-Reset bezel help prevent inadvertent actuation.

The C-Series UL489 breakers employ a unique arc chute design which results in obtaining higher interrupting capacities, up to 50,000 amps. Thermoset glass filled polyester half shell construction for increased mechanical & electrical strength; Wiping Contacts - Mechanical linkage with two-step actuation – cleans contacts, provides high, positive contact pressure & longer contact life; 1-6 poles, 0.02 - 100 amps, up to 480 VAC or 80 VDC, UL489 up to 240 VAC or 125 VDC, with choice of time delays and actuator colors.

Agency Certifications

UL Recognized

UL Standard 1077



Component Recognition Program as Protectors, Supplementary (Guide QVNU2, File E75596)

UL Standard 508



Manual Motor Controls (Guide NLRV2, File E135367)

UL Standard 1500



Protectors, Supplementary for Marine Electrical & Fuel Systems (Guide PEQZ2, File E75596) Ignition Protection

UL Listed

UL Standard 489



Circuit Breakers, Molded Case, (Guide DIVQ, File E129899)

UL Standard 489A



Communications Equipment (Guide CCN/DITT, File E189195)

CSA Certified



Component Supplementary Protector (Class 3215 30, File 047848 0 000 CSA Standard C22.2 No. 235)

Circuit Breaker Molded Case (Class 1432 01, File 093910), CSA Standard C22.2 No. 5.1 - M



VDE Certified

EN60934, VDE 0642 under File No. 10537

Electrical
Table A: Lists UL Recognized & CSA Certified configurations and performance capabilities as a Component Supplementary Protector.

C-SERIES TABLE A: COMPONENT SUPPLEMENTARY PROTECTOR								
CIRCUIT CONFIGURATION	VOLTAGE			CURRENT RATING		INTERRUPTING CAPACITY (AMPS)		CONSTRUCTION NOTES
	MAX RATING	FREQUENCY	PHASE	FULL LOAD AMPS	GENERAL PURPOSE AMPS	UL / CSA		
						WITH BACKUP FUSE ¹	WITHOUT BACKUP FUSE	
SERIES	65	D.C.	---	0.02 - 70	71 - 100	---	5000	
	80	D.C.	---	0.02 - 70	---	---	7500	
	80	D.C.	---	---	71 - 100	---	10,000	Must have Agency Code "L"
	125	50/60	1	0.02 - 100	---	---	5000	Must have Agency Code "L"
	125	50/60	1	71 - 100	---	---	3000	1 Pole
	125/250	50/60	1	0.02 - 50	---	---	3000	2 or 3 Poles Breaking 1Ø
	125/250	50/60	1	51 - 100	---	---	1000	2 or 3 Poles Breaking 1Ø
	125/250	50/60	1	0.02 - 100	---	---	5000	2-3 Poles Breaking 1Ø "L" Agency Code
	250	50/60	1	0.02 - 100	---	---	5000	Must have Agency Code "L"
	250	50/60	1	51 - 70	---	5000	---	
	250	50/60	3	0.02 - 70	---	5000	---	3 Poles Breaking 3Ø
	240	50/60	3	71 - 90	---	---	5000	Must have Agency Code "L"
	277	50/60	1	0.02 - 50	---	5000	---	
DUAL COIL	480/277	50/60	3	0.02 - 30	31 - 50	5000	---	3 Poles breaking 3 Ø
	480	50/60	1	0.02 - 30	31 - 50	5000	---	2 Poles breaking 1 Ø
	80	DC	---	0.02 - 50	---	7500	---	
SHUNT	277	50/60	1	0.02 - 50	---	5000	---	
	250	50/60	3	0.02 - 50	---	5000	---	
	480/277	50/60	3	0.02 - 30	31 - 50	5000	---	3 Poles breaking 3Ø
	480	50/60	1	0.02 - 30	31 - 50	5000	---	2 Poles breaking 1Ø
RELAY	80	DC	---	0.02 - 50	---	7500	---	
	250	50/60	3	0.02 - 50	---	5000	---	
	277	50/60	1	0.02 - 50	---	5000	---	
SWITCH ONLY	65	DC	---	0.02 - 100	---	---	---	
	80	DC	---	0.02 - 70	71 - 100	---	---	
	125	50/60	1	71 - 100	---	---	---	
	125/250	50/60	1	0.02 - 100	---	---	---	2 or 3 Poles Breaking 1Ø
	250	50/60	1 & 3	0.02 - 70	---	---	---	
	277	50/60	1	0.02 - 50	---	---	---	
480/277	50/60	3	0.02 - 30	31 - 50	---	---	3 Poles breaking 3 Ø	

Notes for Table A:

- Requires branch circuit backup with a UL LISTED Type K5 or RK5 fuse rated 15A minimum and no more than 4 times full load amps not to exceed 125A for 50 Amp or less rating and not to exceed 175 for 51 through 100 Amp rating.

Table B: Lists UL Recognized and CSA Certified configurations and performance capabilities as a Manual Motor Controller.

C-SERIES TABLE B: MANUAL MOTOR CONTROLLER					
CIRCUIT CONFIGURATION	VOLTAGE			CURRENT RATING	HORSEPOWER RATINGS
	MAX RATING	FREQUENCY	PHASE	FULL LOAD AMPS	MAX.
SERIES, SHUNT & SWITCH ONLY	277 ¹	50/60	1	0.02 - 20	3 HP
	480 ²	50/60	3	0.02 - 20	5 HP
	250 ¹	50/60	1	0.02 - 20	3 HP
	250 ¹	50/60	3	0.02 - 20	5 HP
	120 ¹	50/60	1	0.02 - 50	3 HP
	120 ¹	50/60	3	0.02 - 50	7 1/2 HP

Notes for Table B:

- Requires branch circuit backup with a UL LISTED Type K5 or RK5 fuse rated 15A minimum and no more than 4 times full load amps not to exceed 125A for 50 Amp or less rating and not to exceed 175 for 51 through 100 Amp rating.
- UL recognized and CSA Certified at 480V refers to 3 & 4 pole versions used in a 3Ø, wye connected circuit or 2-pole version connected with 2 poles breaking, 1Ø and backed up with series fusing as stated above in note 1.

Electrical
Table C: Lists UL Recognized, CSA, VDE and TUV Certified configurations and performance capabilities as a Component Supplementary Protector.

C-SERIES TABLE C: COMPONENT SUPPLEMENTARY PROTECTOR										
CIRCUIT CONFIGURATION	VOLTAGE			CURRENT RATING		INTERRUPTING CAPACITY (AMPS)				CONSTRUCTION NOTES
	MAX RATING	FREQUENCY	PHASE	FULL LOAD AMPS	GENERAL PURPOSE AMPS ¹	UL / CSA		VDE		
						WITH BACKUP FUSE ²	WITHOUT BACKUP FUSE	(Inc) WITH BACKUP FUSE	(Inc) WITHOUT BACKUP FUSE	
SERIES	80	DC	---	0.10 - 70	---	---	7500	---	5000	---
	80	DC	---	71 - 100	71 - 100	---	10,000	---	5000	Agency Code "F" or "H" Only
	250	50/60	1 & 3	0.10 - 70	---	5000	---	3000	1500	---
	415Y/240	50/60	3	0.10 - 30	---	5000	---	3000	1500	Rocker Actuator
	415Y/240	50/60	3	0.10 - 30	---	5000	---	5000	2500	Handle Actuator/ Agency Code H only
DUAL COIL	80	DC	---	0.10 - 30	---	7500	---	---	5000	---
	250	50/60	1 & 3	0.10 - 30	---	5000	---	3000	1500	---
SHUNT	80	DC	---	0.10 - 70	---	---	7500	---	5000	---
	250	50/60	1 & 3	0.10 - 70	---	5000	---	3000	1500	---
	415Y/240	50/60	3	0.10 - 30	---	5000	---	3000	1500	Rocker Actuator
	415Y/240	50/60	3	0.10 - 30	---	5000	---	5000	2500	Handle Actuator/ Agency Code H only

Notes for Table C:

- General Purpose ratings for UL/CSA only.
- Requires branch circuit backup with a UL LISTED Type K5 or RK5 fuse rated 15A minimum and no more than 4 times full load amps not to exceed 125A for 50 Amp or less rating and not to exceed 175 for 51 through 100 Amp rating.

Table D: Lists UL Listed (489), CSA Certified (C22.2 No. 5.1-M) configuration and performance capabilities as a Molded Case Circuit Breaker.

C-SERIES TABLE D: UL489 LISTED BRANCH CIRCUIT BREAKER						
CIRCUIT CONFIGURATION	VOLTAGE			CURRENT RATING	INTERRUPT CAPACITY (AMPS)	CONSTRUCTION NOTES
	MAX RATING	FREQUENCY	PHASE	FULL LOAD AMPS	WITHOUT BACKUP FUSE	
SERIES	80	D.C.	---	0.10 - 100	50,000 ¹	Limited to 2 Poles max from 71 - 100 Amps
	80	D.C.	---	0.10 - 100	10,000	Limited to 2 Poles max from 71 - 100 Amps
	125	D.C.	---	0.01 - 60	5,000	1 - 3 Poles
	120	50 / 60	1	0.10 - 70	10,000	1 - 3 Poles
	240	50 / 60	1	0.10 - 20	5,000	1 or 2 Poles
	240	50 / 60	1	21 - 30	5,000	1 Pole
	80DC/240AC	DC-50/60	1	0.10 - 20	5,000	1 or 2 Poles
	120/240	50 / 60	1	0.10 - 50	5,000	2 or 3 poles. 1 Pole of a 3 Pole Unit is Neutral
DUAL COIL	120	50/60	1	0.10 - 30	10,000	---

Notes from Table D:

- Special catalog number required. Consult factory.

Table E: Lists UL Recognized, CSA Certified configurations and performance capabilities as Protectors, Supplementary for Marine Electrical and Fuel Systems (Guide PEQZ2, File E75596). Ignition Protected per UL 1500. UL Classified Small Craft Electrical Devices, Marine in accordance with ISO 8846 (Guide UZMK, File MQ1515) as Marine Supplementary Protectors.

C-SERIES TABLE E: UL1500 (MARINE IGNITION PROTECTED)						
CIRCUIT CONFIGURATION	VOLTAGE			CURRENT RATING	INTERRUPTING CAPACITY (AMPS)	CONSTRUCTION NOTES
	MAX RATING	FREQUENCY	PHASE	FULL LOAD AMPS	WITHOUT BACKUP FUSE	
SERIES	48	DC	---	0.02 - 100	5000	---
	65	DC	---	0.02 - 100	1500	---
	80	DC	---	0.02 - 70	1500	---
	125	50/60	1	0.02 - 100	1500	---
	250	50/60	1	0.02 - 70	1500	---
	250	50/60	1	71 - 100	1500	2 Poles Breaking 1Ø

Table F: Lists UL Listed configurations and performance capabilities as Circuit Breakers for use in Communications Equipment (Guide DITT, File E189195), under UL489A.

C-SERIES TABLE F: PARALLEL POLE CONSTRUCTION UL489A LISTED FOR COMMUNICATIONS EQUIPMENT					
CIRCUIT CONFIGURATION	VOLTAGE			CURRENT RATING	INTERRUPTING CAPACITY (AMPS)
	MAX RATING	FREQUENCY	PHASE	UL GENERAL PURPOSE (AMPS)	WITHOUT BACKUP FUSE
SERIES	80	DC	---	110 - 250	50,000

Electrical

Maximum Voltage AC, 480 WYE/277 VAC, 50/60 Hz (see Table A.)
UL489: AC, 240 VAC. (See Table D), 50/60 Hz, 125 VDC

Current Rating Standard current coils: 0.100, 0.250, 0.500, 0.750, 1.00, 2.50, 5.00, 7.50, 10.0, 15.0, 25.0, 30.0, 35.0, 40.0, 50.0, 60.0, 70.0, 80.0, 90.0 and 100 amps. Other ratings available, see Ordering Scheme.

Standard Voltage Coils DC - 6V, 12V; AC - 120V; other ratings available, see Ordering Scheme.

Auxiliary Switch Rating SPDT; 10.1 amps-250VAC, DC Aux. Switch 1.0A, 65 VDC. 0.5A, 80VDC, 1/4 HP, 125VAC, VDE & TUV 1.0 125 VAC.

Insulation Resistance Dielectric Strength Minimum of 100 Megohms at 500 VDC. UL, CSA: 1960 V 50/60 Hz for one minute between all electrically isolated terminals. C-Series Circuit Breakers comply with the 8mm spacing and 3750V 50/60 Hz dielectric requirements from hazardous voltage to operator accessible surfaces, between adjacent poles and from main circuits to auxiliary circuits per Publications EN 60950 and VDE 0805.

Resistance, Impedance Values from Line to Load Terminal - based on Series Trip Circuit Breaker.

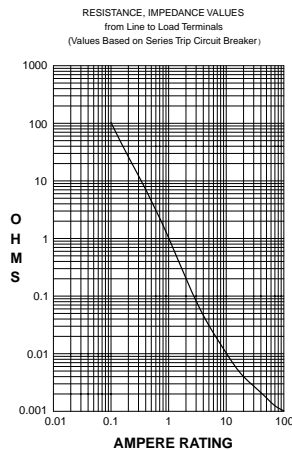

CURRENT (AMPS)	TOLERANCE (%)
0.10 - 5.0	± 15%
5.1 - 20.0	± 25%
20.1 - 100.0	± 35%

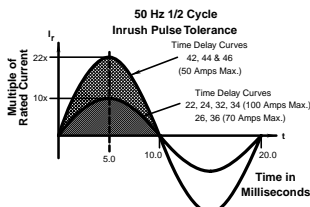
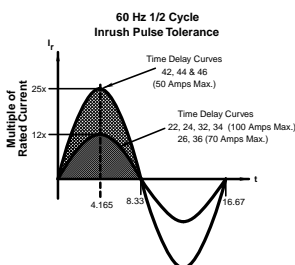
Mechanical

Endurance 10,000 ON-OFF operations @ 6 per minute; with rated current & voltage.

Trip Free All C-Series circuit breakers will trip on overload, even when actuator is forcibly held in the ON position.

Trip Indication The operating actuator moves positively to the OFF position when an overload causes the breaker to trip. With mid-trip, handle moves to the mid position on electrical trip of the circuit breaker. With mid trip handle with alarm switch, handle moves to the mid position and the alarm switch actuates when the circuit

Physical

Number of Poles 1-6 poles ≤ 50A; 1-4 poles @ 51-70A; 1-2 poles 71-100A. UL489 Handle: 1 pole ≤ 100A, 2 pole ≤ 50A; Rocker: 1 pole ≤ 100A.

Internal Circuit Configurations Series (with or without auxiliary switch, mid trip & mid trip with alarm switch) Shunt & Relay with current or voltage trip coils, Dual Coil, Switch Only (with or without aux. switch). UL489: Series (with or without auxiliary switch, mid-trip & mid-trip with alarm switch).

Weight Approx. 112 grams/pole (3.95 oz).

Standard Colors Housing: Black

Environmental

Designed and tested in accordance with requirements of specification MIL-PRF-55629 & MIL-STD-202 as follows:

Shock Withstands 100 Gs, 6ms sawtooth while carrying rated current per Method 213, Test Condition "I". Instantaneous and ultrashort curves tested @ 90% of rated current.

Vibration Withstands 0.060" excursion from 10-55 Hz & 10 Gs 55-500 Hz, @ rated current per Method 204C, Test Cond. A. Instantaneous & ultrashort curves tested @ 90% of rated current.

Moisture Resistance Method 106D, i.e., ten 24-hour cycles @ +25°C to +65°C, 80-98% RH.

Salt Spray Method 101, Condition A (90-95% RH @ 5% NaCl Solution, 96 hrs).

Thermal Shock Method 107D, Condition A (five cycles @ -55°C to +25°C to +85°C to

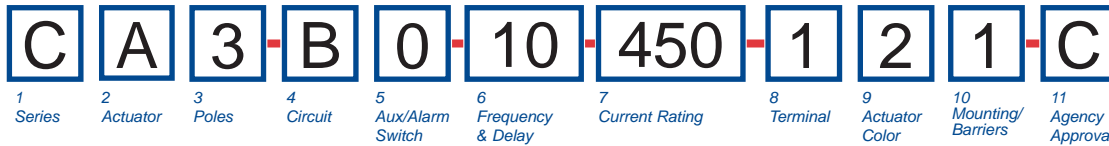

1 SERIES
C

2 ACTUATOR¹
A Handle, one per pole
B Handle, one per multipole unit
S Mid-Trip Handle, one per pole
T Mid-Trip Handle, one per pole & Alarm Switch

3 POLES²		
1 One	3 Three	5 Five
2 Two	4 Four	6 Six

4 CIRCUIT³		
A³ Switch Only (No Coil)	F⁴	Relay Trip (Current)
B Series Trip (Current)	G⁴	Relay Trip (Voltage)
C Series Trip (Voltage)	H^{4,5}	Dual Coil with Shunt Trip Voltage Coil
D⁴ Shunt Trip (Current)	K^{4,5}	Dual Coil with Relay Trip Voltage Coil
E⁴ Shunt Trip (Voltage)		

5 AUXILIARY/ALARM SWITCH⁶		
0 w/o Aux Switch	5	S.P.S.T., 0.110 Q.C. Term. (Gold Contacts)
2 S.P.D.T., 0.110 Q.C. Term.	6	S.P.S.T., 0.139 Solder Lug
3 S.P.D.T., 0.139 Solder Lug	7	S.P.S.T., 0.110 Q.C. Term. (Gold Contacts)
4 S.P.D.T., 0.110 Q.C. Term. (Gold Contacts)	8	S.P.S.T., 0.187 Q.C. Term.
	9	S.P.D.T., 0.187 Q.C. Term.

6 FREQUENCY & DELAY		
03³ DC 50/60Hz, Switch Only	30	DC, 50/60Hz Instantaneous
10⁷ DC Instantaneous	31	DC, 50/60Hz Ultra Short
11 DC Ultra Short	32	DC, 50/60Hz Short
12 DC Short	34	DC, 50/60Hz Medium
14 DC Medium	36	DC, 50/60Hz Long
16 DC Long	42⁸	50/60Hz Short, Hi-Inrush
20⁷ 50/60Hz Instantaneous	44⁸	50/60Hz Medium, Hi-Inrush
21 50/60Hz Ultra Short	46⁸	50/60Hz Long, Hi-Inrush
22 50/60Hz Short	52⁸	DC, Short, Hi-Inrush
24 50/60Hz Medium	54⁸	DC, Medium, Hi-Inrush
26 50/60Hz Long	56	DC, Long, Hi-Inrush

7 CURRENT RATING (AMPERES)⁷									
020	0.020	235	0.350	430	3.000	614	14.000		
025	0.025	240	0.400	435	3.500	615	15.000		
030	0.030	245	0.450	440	4.000	616	16.000		
035	0.035	250	0.500	445	4.500	617	17.000		
040	0.040	255	0.550	450	5.000	618	18.000		
045	0.045	260	0.600	455	5.500	620	20.000		
050	0.050	265	0.650	460	6.000	622	22.000		
055	0.055	270	0.700	465	6.500	624	24.000		
060	0.060	275	0.750	470	7.000	625	25.000		
065	0.065	280	0.800	475	7.500	630	30.000		
070	0.070	285	0.850	480	8.000	635⁵	35.000		
075	0.075	290	0.900	485	8.500	640⁵	40.000		
080	0.080	295	0.950	490	9.000	650⁵	50.000		
085	0.085	410	1.000	495	9.500	660⁵	60.000		
090	0.090	512	1.250	610	10.000	670⁵	70.000		
095	0.095	415	1.500	710	10.500	680⁵	80.000		
210	0.100	517	1.750	611	11.000	685⁵	85.000		
215	0.150	420	2.000	711	11.500	690⁵	90.000		
220	0.200	522	2.250	612	12.000	695⁵	95.000		
225	0.250	425	2.500	712	12.500	810⁵	100.000		
230	0.300	527	2.750	613	13.000				

OR VOLTAGE COIL (NOMINAL RATED VOLTAGE)⁷									
A06	6 DC	A32	32 DC	J12	12 AC	J65	65 AC		
A12	12 DC	A48	48 DC	J18	18 AC	K20	120 AC		
A18	18 DC	A65	65 DC	J24	24 AC	L40	240 AC		
A24	24 DC	J06	6 AC	J48	48 AC				

8 TERMINAL¹⁵		
1¹⁰ Stud 10-32, threaded .625 long	5¹¹	Screw M5 x 0.8 w/saddle & washer clamp
2¹¹ Screw 8-32 w/saddle & washer clamps	6¹²	Stud M6 threaded, 17mm long
3¹² Stud 1/4-20, threaded .625 long	7¹³	0.250 Double Quick Connect
4¹¹ Stud M5 x 0.8, threaded 16mm long	8	1/4" Clip Terminal
	9	7/16" Clip Terminal
	A¹⁴	Plug-In Stud
	C	5/16" Clip Terminal

9 ACTUATOR COLOR & LEGEND¹⁶				
Actuator Color	I-O	ON-OFF	Dual	Legend Color
White	A	B	1	Black
Black	C	D	2	White
Red	F	G	3	White
Green	H	J	4	White
Blue	K	L	5	White
Yellow	M	N	6	Black
Gray	P	Q	7	Black
Orange	R	S	8	Black
Black (short handle) ¹⁷	T	U	9	White

10 MOUNTING/BARRIERS			
	MOUNTING STYLE	BARRIERS	VOLTAGE
	Threaded Insert		
1	6-32 x 0.195 inches	no	< 300
A	6-32 X 0.195 inches	yes	< 300
C¹⁸	6-32 X 0.195 inches	yes	≥ 300
2	ISO M3 x 5mm	no	< 300
B	ISO M3 x 5mm	yes	< 300
D¹⁸	ISO M3 x 5mm	yes	≥ 300
	Front panel Snap-In, 1.00" [25.4mm] wide bezel		
E¹⁷	with Handleguard	no	< 300

11 AGENCY APPROVAL	
C	UL Recognized & CSA Certified
D	VDE Certified, UL Recognized & CSA Certified
H	UL489 Construction: VDE Certified, UL Recognized & CSA Certified
I	UL Rec. STD 1077, UL Rec. 1500 (ignition protected), & CSA Certified

- Notes:
- Actuator Code:
 - A: Handle tie pin spacer(s) and retainers provided unassembled with multi-pole units.
 - B: Handle location as viewed from front of breaker:
 - 2 pole - left pole
 - 3 pole - center pole
 - 4 pole - two handles at center poles
 - 5 pole - three handles at center poles
 - 6 pole - four handles at center poles
 - S: Handle moves to mid-position only upon electrical trip of the breaker. Available with circuit codes B, C, D, E, F, G, H and K.
 - T: Handle moves to mid-position and alarm switch activates only upon electrical trip of the breaker. Available with circuit codes B & C.
 - Standard multipole units have all poles identical except when specifying auxiliary switch and/or mixed poles. 4 pole max w/VDE. 5th pole available as Series Trip w/Voltage Coil only.
 - Switch Only circuits, rated up to 50 amps and 6 poles, and only available with VDE Certification when tied to a protected pole (Circuit Code B, C, D or H.). For .02 to 30 amps, select Current Code 630. For 35 - 50 amps, select Current Code 650.
 - Circuit Codes D,E,F,G,H & K available with Terminal Codes 1,2,4 & 5 only. Circuit Codes D, F, H & K available up to 50 amps maximum Current Rating.
 - Consult factory for available Dual Coil options, as special catalog number is required. Dual Coil Voltage Coils with Shunt Trip Construction trip instantaneously on line voltage. Dual Coil Voltage Coils require 30VA minimum power to trip instantaneously and are rated for intermittent duty only.
 - Auxiliary Switch available with Series Trip and Switch Only circuits. On multi-pole breakers, one aux. switch is supplied, mounted in the extreme right pole.
 - Voltage coils not rated for continuous duty. Available only with delay codes 10 and 20.
 - Available with Circuit Codes B & D only, and up to 50 amps maximum.
 - Current rating Codes 660 through 810 are available with Circuit Codes A & B only. Current Ratings 60 - 70 are available up to four poles maximum. Ratings 71 - 100 are available up to two poles maximum.
 - Terminal Code 1 available to 60 amps maximum.
 - Terminal Codes 2,4,5 and C available to 50 amps maximum.
 - Terminal Codes 3,6 & 9 available to 100 amps maximum.
 - Terminal Code 7 available to 25 amps maximum.
 - Terminal Code A available to 100 amps maximum.
 - Terminal Codes 7,8,9 & C are not VDE approved.
 - No marking available. Consult factory. VDE Approval requires dual (I-O, ON-OFF) or I-O markings on all handles.
 - Single pole only.
 - VDE/TUV: 30 amps max.; UL/CSA: 50 amps max.; Available in 2 - 4 poles only and limited to AC Delays. "General Purpose amps" not rated for "full load amps" or to be used in applications with a motor.

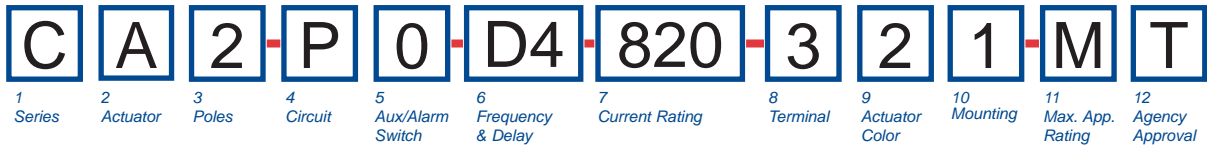

1 SERIES	
C	
2 ACTUATOR¹	
A	Handle, one per pole
S	Mid-Trip Handle, one per pole
T	Mid-Trip Handle, one per pole & Alarm Switch
3 POLES³	
2	Two
3	Three
4 CIRCUIT	
P Series Trip (Parallel Pole)	
5 AUXILIARY/ALARM SWITCH	
0	w/o Aux Switch
2	S.P.D.T., 0.110 Q.C. Term.
3	S.P.D.T., 0.139 Solder Lug
4	S.P.D.T., 0.110 Q.C. Term. (Gold Contacts)
5	S.P.S.T., 0.093 Q.C. Term. (Gold Contacts)
6	S.P.S.T., 0.139 Solder Lug
7	S.P.S.T., 0.110 Q.C. Term. (Gold Contacts)
8	S.P.S.T., 0.187 Q.C. Term.
9	S.P.D.T., 0.187 Q.C. Term.
6 FREQUENCY & DELAY	
D1	DC Ultra Short
D2	DC Short
D4	DC Medium
D6	DC Long
7 CURRENT RATING (AMPERES)	
811	110.000
812	120.000
912	125.000
813	130.000
814	140.000
815	150.000
816	160.000
817	170.000
917	175.000
818	180.000
819	190.000
820	200.000
922²	225.000
825²	250.000

8 TERMINAL²			
3	1/4 - 20 Threaded Stud, .675 long		
6	M6 Threaded Stud, 17 mm long		
A	Plug-In Stud		
9 ACTUATOR COLOR			
LEGEND			
	ON-OFF	Dual	Legend Color
White	B	1	Black
Black	D	2	White
Red	G	3	White
Green	J	4	White
Blue	L	5	White
Yellow	N	6	Black
Gray	Q	7	Black
Orange	S	8	Black
10 MOUNTING			
MOUNTING STYLE			
Threaded Insert			
1	6-32 x 0.195 inches		
2	ISO M3 x 5mm		
11 MAXIMUM APPLICATION RATING			
M	80 DC		
12 AGENCY APPROVAL			
T	UL489A Listed		

Notes:

- Actuator Code:
 A: Handle tie pin spacer(s) and retainers provided unassembled with multi-pole units.
 S: Handle moves to mid-position only upon electrical trip of the breaker.
 T: Handle moves to mid-position and alarm switch activates only upon electrical trip of the breaker.
- Terminal Code:
 3 & 6: Supplied with bus bars connecting the Line and Load Terminals.
 A: Line and Load Terminals must be connected to a copper bus bar having a minimum cross section of 0.078 square inches.
- Above 200 amps, 3 poles are required.

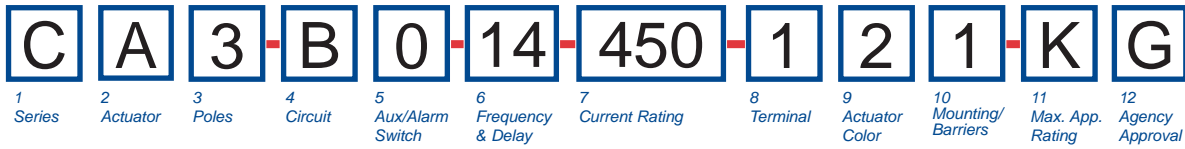

1 SERIES	
C	
2 ACTUATOR¹	
A	Handle, one per pole
B	Handle, one per multipole unit
S	Mid-Trip Handle, one per pole
T	Mid-Trip Handle, one per pole & Alarm Switch
3 POLES²	
1	One
2	Two
3	Three
4 CIRCUIT	
B Series Trip (Current)	
5 AUXILIARY/ALARM SWITCH³	
0	w/o Aux Switch
2	S.P.D.T., 0.110 Q.C. Term.
3	S.P.D.T., 0.139 Solder Lug
4	S.P.D.T., 0.110 Q.C. Term. (Gold Contacts)
5	S.P.S.T., 0.110 Q.C. Term. (Gold Contacts)
6	S.P.S.T., 0.139 Solder Lug
7	S.P.S.T., 0.110 Q.C. Term. (Gold Contacts)
8	S.P.S.T., 0.187 Q.C. Term.
9	S.P.D.T., 0.187 Q.C. Term.

6 FREQUENCY & DELAY			
11	DC Ultra Short	26	50/60Hz Long
12	DC Short	42 ⁴	50/60Hz Short, Hi-Inrush
14	DC Medium	44 ⁴	50/60Hz Medium, Hi-Inrush
16	DC Long	46 ⁴	50/60Hz Long, Hi-Inrush
21	50/60Hz Ultra Short	52 ⁴	DC, Short, Hi-Inrush
22	50/60Hz Short	54 ⁴	DC, Medium, Hi-Inrush
24	50/60Hz Medium	56 ⁴	DC, Long, Hi-Inrush

7 CURRENT RATING (AMPERES)⁵							
020	0.020	235	0.350	430	3.000	614	14.000
025	0.025	240	0.400	435	3.500	615	15.000
030	0.030	245	0.450	440	4.000	616	16.000
035	0.035	250	0.500	445	4.500	617	17.000
040	0.040	255	0.550	450	5.000	618	18.000
045	0.045	260	0.600	455	5.500	620	20.000
050	0.050	265	0.650	460	6.000	622	22.000
055	0.055	270	0.700	465	6.500	624	24.000
060	0.060	275	0.750	470	7.000	625	25.000
065	0.065	280	0.800	475	7.500	630	30.000
070	0.070	285	0.850	480	8.000	635	35.000
075	0.075	290	0.900	485	8.500	640	40.000
080	0.080	295	0.950	490	9.000	650	50.000
085	0.085	410	1.000	495	9.500	660	60.000
090	0.090	512	1.250	610	10.000	670	70.000
095	0.095	415	1.500	710	10.500	680	80.000
210	0.100	517	1.750	611	11.000	685	80.000
215	0.150	420	2.000	711	11.500	690	90.000
220	0.200	522	2.250	612	12.000	695	90.000
225	0.250	425	2.500	712	12.500	810	100.000
230	0.300	527	2.750	613	13.000		

8 TERMINAL⁶			
1 ⁷	Stud 10-32, threaded .625	5 ⁸	Screw M5 x 0.8 w/saddle & washer clamp
2 ⁸	Screw 8-32 w/saddle & washer clamps	6 ⁹	Stud M6 threaded, 17mm long
3 ⁹	Stud 1/4-20, threaded .625 long	8	1/4" Clip Terminal
4 ⁸	Stud M5 x 0.8, threaded 16mm long	9 ⁹	7/16" Clip Terminal
		A ¹⁰	Push-In Stud
		C	5/16" Clip Terminal

9 ACTUATOR COLOR & LEGEND¹¹			
Actuator Color	ON-OFF	Dual	Legend Color
White	B	1	Black
Black	D	2	White
Red	G	3	White
Green	J	4	White
Blue	L	5	White
Yellow	N	6	Black
Gray	Q	7	Black
Orange	S	8	Black

10 MOUNTING/BARRIERS		
MOUNTING STYLE		BARRIERS
<i>Threaded Insert</i>		
1	6-32 x 0.195 inches	yes
2	ISO M3 x 5mm	yes

11 MAXIMUM APPLICATION RATING	
A	65 DC
B	125 DC
C	120/240 AC ²
D	240 AC
K	120 AC
M	80 DC

12 AGENCY APPROVAL¹¹	
A	w/o approvals
F	UL489 Listed, CSA Certified & VDE Certified
G	UL489 Listed & CSA Certified
J	UL489 Listed, CSA Certified & TUV Certified

- Notes:
- Actuator Code:
A: Handle tie pin spacer(s) and retainers provided unassembled with multi-pole units.
B: Handle located, as viewed from front of breaker in left pole. 2 pole maximum.
S: Handle moves to mid-position only upon electrical trip of the breaker.
T: Handle moves to mid-position and alarm switch activates only upon electrical trip of the breaker.
 - Standard multipole units have all poles identical except when specifying auxiliary switch and/or mixed poles.
2 & 3 pole circuit breakers required for 120/240 VAC (Maximum application rating code C) applications, have all poles identical except when specifying auxiliary / alarm switch which is normally supplied in extreme right pole per figure B. These units are available with one handle per pole only and terminal barrier is required.
Third pole is for 120/240 VAC applications requiring neutral disconnect. The 3rd pole has the same construction as poles 1 & 2.
 - On multi-pole breakers, one auxiliary, switch is supplied, mounted in the extreme right pole. VDE approval on auxiliary switch codes 2, 3 & 4 only.
Auxiliary / Alarm Switch with Independent Circuit ie: separate from breaker circuit, only available with circuit breakers rated 50 amp maximum at 80 VDC, 125 VDC, and 120 VAC.
Auxiliary / Alarm Switch with Dependent Circuit ie: same as circuit breaker, is supplied from factory with common terminal of auxiliary / alarm switch connected to line terminal on 120/240 and 240 VAC ratings. Circuit breakers rated 120 VAC 50 amp maximum can be supplied with Auxiliary/Alarm switch common terminal connected to breaker line terminal. Consult factory for special catalog number.
Available up to 50 amps maximum.
 - Current ratings 71 - 100 with VDE approvals are available up to two poles maximum.
 - Terminal Codes 8, 9 & C are not VDE approved.
 - Terminal Code 1 available to 60 amps maximum.
 - Terminal Codes 2, 4, 5 & C available to 50 amps maximum.
 - Terminal Codes 3, 6 & 9 available to 100 amps maximum.
 - Terminal Code A available to 100 amps maximum.
 - VDE and TUV approvals require Dual (I-O, ON-OFF) markings on all handles.

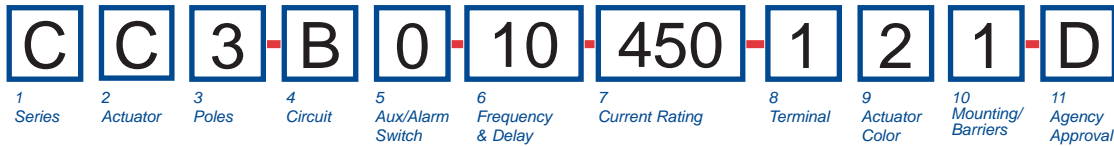

1 SERIES
C

2 ACTUATOR ¹
Two Color Visi-Rocker

C Indicate ON, vertical legend	J Vertical legend
D Indicate ON, horizontal legend	K Horizontal legend
E Indicate ON, no legend	L No legend
F Indicate OFF, vertical legend	
G Indicate OFF, horizontal legend	
H Indicate OFF, no legend	

Push-To-Reset, Visi-Rocker

N Indicate OFF, vertical legend	R Vertical legend
O Indicate OFF, horizontal legend	U Horizontal legend
P Indicate OFF, no legend	V No legend

Single color

Push-To-Reset, Single color

ROCKER STYLE DESCRIPTIONS

	INDICATE 'ON'	INDICATE 'OFF'	SINGLE COLOR
VERTICAL STYLE	CODE 'C'	CODE 'J', 'N'	CODE 'U', 'R'
	CODE 'D'	CODE 'G', 'O'	CODE 'K', 'L', 'V'
HORIZONTAL STYLE	CODE 'C'	CODE 'J', 'N'	CODE 'U', 'R'
	CODE 'D'	CODE 'G', 'O'	CODE 'K', 'L', 'V'

3 POLES²
1 One **2** Two **3** Three

4 CIRCUIT

A³ Switch Only (No Coil)	F⁴ Relay Trip (Current)
B Series Trip (Current)	G⁴ Relay Trip (Voltage)
C Series Trip (Voltage)	H^{4,5} Dual Coil with Shunt Trip Voltage Coil
D⁴ Shunt Trip (Current)	K^{4,5} Dual Coil with Relay Trip Voltage Coil
E⁴ Shunt Trip (Voltage)	

5 AUXILIARY/ALARM SWITCH⁶

0 w/o Aux Switch	5 S.P.S.T., 0.093 Q.C. Term. (Gold Contacts)
2 S.P.D.T., 0.110 Q.C. Term.	6 S.P.S.T., 0.139 Solder Lug
3 S.P.D.T., 0.139 Solder Lug	7 S.P.S.T., 0.110 Q.C. Term. (Gold Contacts)
4 S.P.D.T., 0.110 Q.C. Term. (Gold Contacts)	8 S.P.S.T., 0.187 Q.C. Term.
	9 S.P.D.T., 0.187 Q.C. Term.

6 FREQUENCY & DELAY

03 DC 50/60Hz, Switch Only	30 DC, 50/60Hz Instantaneous
10⁷ DC Instantaneous	31 DC, 50/60Hz Ultra Short
11 DC Ultra Short	32 DC, 50/60Hz Short
12 DC Short	34 DC, 50/60Hz Medium
14 DC Medium	36 DC, 50/60Hz Long
16 DC Long	42⁸ 50/60Hz Short, Hi-Inrush
20⁷ 50/60Hz Instantaneous	44⁸ 50/60Hz Medium, Hi-Inrush
21 50/60Hz Ultra Short	46⁸ 50/60Hz Long, Hi-Inrush
22 50/60Hz Short	52⁸ DC, Short, Hi-Inrush
24 50/60Hz Medium	54⁸ DC, Medium, Hi-Inrush
26 50/60Hz Long	56⁸ DC, Long, Hi-Inrush

Notes:

- Push-To-Reset actuators have OFF portion of rocker shrouded.
- Multi-pole breakers have all poles identical except when specifying Aux. switch and/or mixed poles, and have one rocker per breaker. Rocker location as viewed from front panel: 2 pole – left pole; 3 pole – center pole.
- Switch Only circuits, rated up to 50 amps and 3 poles, and only available with VDE Certification when tied to a protected pole (Circuit Code B, C, D or H.). For .02 to 30 amps, select Current Code 630. For 35 - 50 amps, select Current Code 650.
- Circuit Codes D,E,F,G,H & K available with Terminal Codes 1,2,4 & 5 only. Circuit Codes D,F,H & K available up to 50 amps maximum Current Rating.
- Consult factory for available Dual Coil options, as special catalog number is required. Dual Coil Voltage Coils with Shunt Trip Construction trip instantaneously on line voltage. Dual Coil Voltage Coils require 30VA minimum power to trip instantaneously and are rated for intermittent duty only.
- Auxiliary Switch available with Series Trip and Switch Only circuits. On multi-pole breakers, one aux. switch is supplied, mounted in the extreme right pole. Auxiliary switch codes 2,3 & 4 are VDE approved.
- Voltage coils not rated for continuous duty. Available only with delay codes 10 and 20.
- Available with Circuit Codes B & D only, and up to 50 amps maximum.
- Current rating Codes 660 through 810 are available with Circuit Codes A & B only. Ratings 71 - 100 are available up to two poles maximum. Ratings 60-70 are available up to four poles maximum.
- Terminal Code 1 available to 60 amps maximum.
- Terminal Codes 2,4,5 & C available to 50 amps maximum.
- Terminal Codes 3,6 & 9 available to 100 amps maximum.
- Terminal Code 7 available to 25 amps maximum.
- Terminal Code A available to 100 amps maximum.
- Terminal Codes 7,8,9 & C are not VDE approved.
- Color shown is visi and legend with remainder of rocker black
- Legend on Push-to-reset bezel/shroud is white when single color rocker is ordered. Dual = ON-OFF/I-O legend with actuator codes C - G, and J, K, N, O, R, & U. None = no legend with actuator codes H, L, P, V. Rockerguard available with actuator codes C - L. Push-to-reset available with actuator codes N, O, P, R, U, V.
- VDE approval requires Dual (I-O, ON-OFF) or I-O markings on rocker.
- VDE/TUV: 30 amps max.; UL/CSA: 50 amps max.; Available in 2 - 4 poles only and limited to AC Delays.
- "General Purpose amps" not rated for "full load amps" or to be used in applications with a motor.

7 CURRENT RATING (AMPERES)⁹

020	0.020	235	0.350	430	3.000	614	14.000
025	0.025	240	0.400	435	3.500	615	15.000
030	0.030	245	0.450	440	4.000	616	16.000
035	0.035	250	0.500	445	4.500	617	17.000
040	0.040	255	0.550	450	5.000	618	18.000
045	0.045	260	0.600	455	5.500	620	20.000
050	0.050	265	0.650	460	6.000	622	22.000
055	0.055	270	0.700	465	6.500	624	24.000
060	0.060	275	0.750	470	7.000	625	25.000
065	0.065	280	0.800	475	7.500	630	30.000
070	0.070	285	0.850	480	8.000	635⁵	35.000
075	0.075	290	0.900	485	8.500	640⁵	40.000
080	0.080	295	0.950	490	9.000	650⁵	50.000
085	0.085	410	1.000	495	9.500	660⁵	60.000
090	0.090	512	1.250	610	10.000	670⁵	70.000
095	0.095	415	1.500	710	10.500	680⁵	80.000
210	0.100	517	1.750	611	11.000	685⁵	85.000
215	0.150	420	2.000	711	11.500	690⁵	90.000
220	0.200	522	2.250	612	12.000	695⁵	95.000
225	0.250	425	2.500	712	12.500	810⁵	100.000
230	0.300	527	2.750	613	13.000		

OR VOLTAGE COIL (NOMINAL RATED VOLTAGE)¹⁰

A06 6 DC	A32 32 DC	J12 12 AC	J65 65 AC
A12 12 DC	A48 48 DC	J18 18 AC	K20 120 AC
A18 18 DC	A65 65 DC	J24 24 AC	L40 240 AC
A24 24 DC	J06 6 AC	J48 48 AC	

8 TERMINAL

1¹⁰ Stud 10-32, threaded .625 long	5¹¹ Screw M5 x 0.8 w/saddle & washer clamp
2¹¹ Screw 8-32 w/saddle & washer clamps	6¹² Stud M6 threaded, 17mm long
3¹² Stud 1/4-20, threaded .625 long	7¹³ 0.250 Double Quick Connect
4¹¹ Stud M5 x 0.8, threaded 16mm long	8 1/4" Clip Terminal
	9 7/16" Clip Terminal
	A¹⁴ Plug-In Stud
	C 5/16" Clip Terminal

9 ACTUATOR COLOR & LEGEND^{16, 17, 18}

Actuator or Visi-Color	Marking:	Marking Color:	Single Color Rocker/Handle	Visi-Rocker
Color:	I-O	ON-OFF	Dual/None	
White	A	B	1	Black
Black	C	D	2	White
Red	F	G	3	White
Green	H	J	4	White
Blue	K	L	5	White
Yellow	M	N	6	Black
Gray	P	Q	7	Black
Orange	R	S	8	Black

10 MOUNTING/BARRIERS¹

	STANDARD ROCKER BEZEL	BARRIERS	VOLTAGE
1	6-32 x 0.195 inches	no	<300
2	6-32 x 0.195 inches	yes	<300
3¹⁹	6-32 x 0.195 inches	yes	≥300
4	ISO M3 x 5mm	no	<300
5	ISO M3 x 5mm	yes	<300
6¹⁹	ISO M3 x 5mm	yes	≥300
ROCKERGARD BEZEL			
A	6-32 x 0.195 inches	no	<300
C	6-32 x 0.195 inches	yes	<300
E¹⁹	6-32 x 0.195 inches	yes	≥300
G	ISO M3 x 5mm	no	<300
J	ISO M3 x 5mm	yes	<300
L¹⁹	ISO M3 x 5mm	yes	≥300
PUSH-TO-RESET BEZEL			
B	6-32 x 0.195 inches	no	<300
D	6-32 x 0.195 inches	yes	<300
F¹⁹	6-32 x 0.195 inches	yes	≥300
H	ISO M3 x 5mm	no	<300
J	ISO M3 x 5mm	yes	<300
M¹⁹	ISO M3 x 5mm	yes	≥300

11 AGENCY APPROVAL

C	UL Recognized & CSA Certified
D	VDE Certified, UL Recognized & CSA Certified
H	UL489 Construction: VDE Certified, UL Recognized & CSA Certified
I	UL Rec. STD 1077, UL Rec. 1500 (ignition protected), & CSA Certified

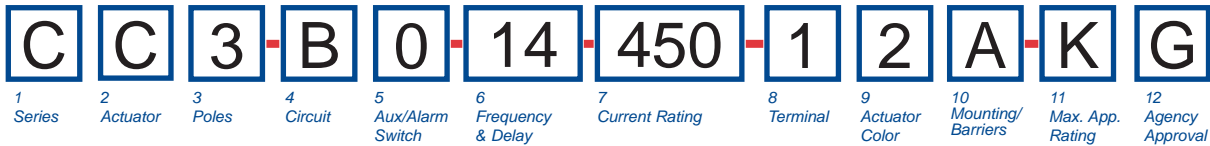

1 SERIES
C

2 ACTUATOR¹
Two Color Visi-Rocker

Single color

C Indicate ON, vertical legend J Vertical legend
D Indicate ON, horizontal legend K Horizontal legend
F Indicate OFF, vertical legend
G Indicate OFF, horizontal legend

ROCKER STYLE DESCRIPTIONS

VERTICAL STYLE	INDICATE "ON" CODE "C" 	INDICATE "OFF" CODE "F" 	SINGLE COLOR CODE "J"
	INDICATE COLOR LOCATION 	CODE "D" 	CODE "G"
HORIZONTAL STYLE	CODE "K" 	CODE "G" 	CODE "K"

3 POLES¹

1	One	2	Two	3	Three
---	-----	---	-----	---	-------

4 CIRCUIT

B Series Trip (Current)

5 AUXILIARY/ALARM SWITCH²

0	w/o Aux Switch	5	S.P.S.T., 0.093 Q.C. Term. (Gold Contacts)
2	S.P.D.T., 0.110 Q.C. Term.	6	S.P.S.T., 0.139 Solder Lug
3	S.P.D.T., 0.139 Solder Lug	7	S.P.S.T., 0.110 Q.C. Term. (Gold Contacts)
4	S.P.D.T., 0.110 Q.C. Term. (Gold Contacts)	8	S.P.S.T., 0.187 Q.C. Term.
		9	S.P.D.T., 0.187 Q.C. Term.

6 FREQUENCY & DELAY

11	DC Ultra Short	26	50/60Hz Long
12	DC Short	42 ³	50/60Hz Short, Hi-Inrush
14	DC Medium	44 ³	50/60Hz Medium, Hi-Inrush
16	DC Long	46 ³	50/60Hz Long, Hi-Inrush
21	50/60Hz Ultra Short	52 ³	DC, Short, Hi-Inrush
22	50/60Hz Short	54 ³	DC, Medium, Hi-Inrush
24	50/60Hz Medium	56 ³	DC, Long, Hi-Inrush

7 CURRENT RATING (AMPERES)⁴

020	0.020	235	0.350	430	3.000	614	14.000
025	0.025	240	0.400	435	3.500	615	15.000
030	0.030	245	0.450	440	4.000	616	16.000
035	0.035	250	0.500	445	4.500	617	17.000
040	0.040	255	0.550	450	5.000	618	18.000
045	0.045	260	0.600	455	5.500	620	20.000
050	0.050	265	0.650	460	6.000	622	22.000
055	0.055	270	0.700	465	6.500	624	24.000
060	0.060	275	0.750	470	7.000	625	25.000
065	0.065	280	0.800	475	7.500	630	30.000
070	0.070	285	0.850	480	8.000	635	35.000
075	0.075	290	0.900	485	8.500	640	40.000
080	0.080	295	0.950	490	9.000	650	50.000
085	0.085	410	1.000	495	9.500	660	60.000
090	0.090	512	1.250	610	10.000	670	70.000
095	0.095	415	1.500	710	10.500	680	80.000
210	0.100	517	1.750	611	11.000	685	85.000
215	0.150	420	2.000	711	11.500	690	90.000
220	0.200	522	2.250	612	12.000	695	95.000
225	0.250	425	2.500	712	12.500	810	100.000
230	0.300	527	2.750	613	13.000		

8 TERMINAL

1 ⁵	Stud 10-32, threaded .625 long	5 ⁶	Screw M5 x 0.8 w/saddle & washer clamp
2 ⁶	Screw 8-32 w/saddle & washer clamps	6 ⁷	Stud M6 threaded, 17mm long
3 ⁷	Stud 1/4-20, threaded .625 long	8 ⁸	1/4" Clip Terminal
4 ⁶	Stud M5 x 0.8, threaded 16mm long	9 ^{7,8}	7/16" Clip Terminal
		A ^{7,8}	Push-In Stud
		C ^{6,8}	5/16" Clip Terminal

9 ACTUATOR COLOR & LEGEND¹¹

Actuator or Visi-Color ⁹	Marking:		Marking Color:	
Color:	ON-OFF	Dual ¹⁰	Single Color	Rocker/Handle
White	B	1	Black	White
Black	D	2	White	n/a
Red	G	3	White	Red
Green	J	4	White	Green
Blue	L	5	White	Blue
Yellow	N	6	Black	Yellow
Gray	Q	7	Black	Gray
Orange	S	8	Black	Orange

10 MOUNTING/BARRIERS¹²

	STANDARD ROCKER BEZEL Threaded Insert, 2 per pole	BARRIERS
A	6-32 X 0.195 inches	yes
C	ISO M3 x 5mm	yes
	ROCKERGUARD BEZEL Threaded Insert, 2 per pole	
B	6-32 x 0.195 inches	yes
D	ISO M3 x 5mm (multi-pole units only)	yes

11 MAXIMUM APPLICATION RATING

A	65 DC
B	125 DC
C	120/240 AC
D	240 AC
K	120 AC
M	80 DC

12 AGENCY APPROVAL

A	without approvals
F	UL 489 Listed, CSA Certified, & VDE Certified
G	UL 489 Listed & CSA Certified
J	UL489 Listed, CSA Certified & TUV Certified

Notes:

- Multi-pole breakers have all breakers identical except when specifying Aux. switch and/or mixed poles, and have one rocker per breaker.
- On multi-pole breakers, one aux. switch is supplied, mounted in the extreme right pole.
- Available up to 50 amps maximum.
- Current ratings 71 - 100 with VDE approvals are available up to two poles maximum.
- Terminal Code 1 available to 60 amps maximum.
- Terminal Codes 2, 4, 5 & C available to 50 amps maximum.
- Terminal Codes 3, 6, 9 & A available to 100 amps maximum.
- Terminal Codes 8, 9 & C are not VDE approved.
- Color shown is visi and legend with remainder of rocker black
- Dual = ON-OFF/I-O legend on actuator.
- VDE and TUV approval requires Dual (I-O, ON-OFF) markings on rocker.
- Rockerguard available with all actuator codes.

DESCRIPTION	CODE	DIMENSIONAL DETAIL	RATING (AMPS)		
			25	50	100
#10-32 STUD	1				
M5 STUD	4				
#1/4-20 STUD	3				
M6 STUD	6				
#10-32 SCREW	2				
M-5 SCREW	5				
.250 DOUBLE Q.C.	7				
1/4" CLIP TERMINALS	8				
7/16" CLIP TERMINALS	9				
PUSH-IN STUD	A				

NOTE: TOLERANCE ON STUD LENGTHS IS ±.031 [±.79] UNLESS OTHERWISE SPECIFIED

CIRCUIT BREAKER MODE	HANDLE POSITION VS. AUX/ALARM SWITCH MODE					
	STANDARD C/B			MID TRIP C/B		
	HANDLE POSITION	AUX. SWITCH MODE	HANDLE POSITION	STANDARD ALARM SWITCH MODE	REVERSE ALARM SWITCH MODE ⁴	
OFF						
ON						
ELECTRICAL TRIP						

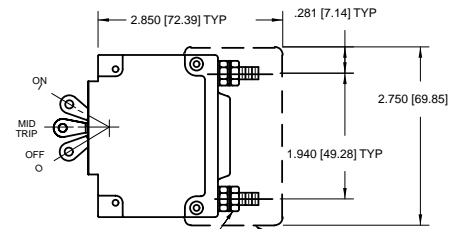

STUD TERMINAL VERSION IS SUPPLIED WITH 2 HEX NUTS AND FLAT WASHERS/TERMINAL SCREW TERMINAL VERSION IS SUPPLIED WITH #10-32 SCREW, FLAT WASHER AND SADDLE CLAMP/TERMINAL. THE SADDLE CLAMP IS FOR DIRECT WIRE CONNECTION USE. DISCARD SADDLE CLAMP IF WIRE TERMINAL LUG IS USED

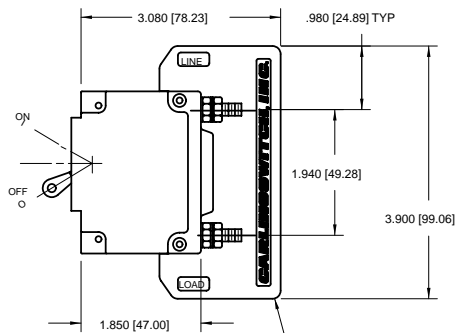

AUXILIARY / ALARM SWITCH TERMINAL DETAIL³

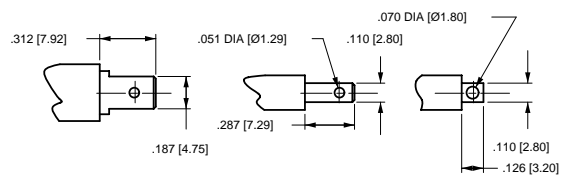

TAB (Q.C.) .187 TAB (Q.C.) .110 SOLDER TYPE

Notes:

- All dimensions are in inches [millimeters].
- Tolerance ±.010 [0.25] unless otherwise specified.
- Available on Series Trip and Switch Only Circuits when called for on multi-pole units. Only one aux. switch is normally supplied, as viewed in multi-pole identification scheme.
- Available only as special catalog number.

	CIRCUIT SCHEMATIC		CIRCUIT CODE	AUX SWITCH CODE	CIRCUIT SCHEMATIC		CIRCUIT CODE	AUX SWITCH CODE
	ANSI	IEC			ANSI	IEC		
	SWITCH ONLY (NO COIL)				SERIES TRIP			
			A	O			B C	O
			A	2 3 4			B C	2 3 4
			D E	0			H	0
			F G	0			K	0

TABLE A	
TIGHTENING TORQUE SPECIFICATIONS	
THREAD SIZE	TORQUE
#6-32 [M3] MOUNTING INSERTS	7-9 IN-LBS [0.8-1.0 NM]
#10-32 & M5 THD STUDS	15-20 IN-LBS [1.7-2.3 NM]
#10-32 THD SCREW	15-20 IN-LBS [1.7-2.3 NM]
#1/4-20 & M6 THD STUDS	30-35 IN-LBS [3.4-4.0 NM]

Notes:
 1 All dimensions are in inches [millimeters].
 2 Tolerance ±.015 [.38] unless otherwise specified.
 3 Schematic shown represents current trip circuits.

PARALLEL POLE (CA2-P)

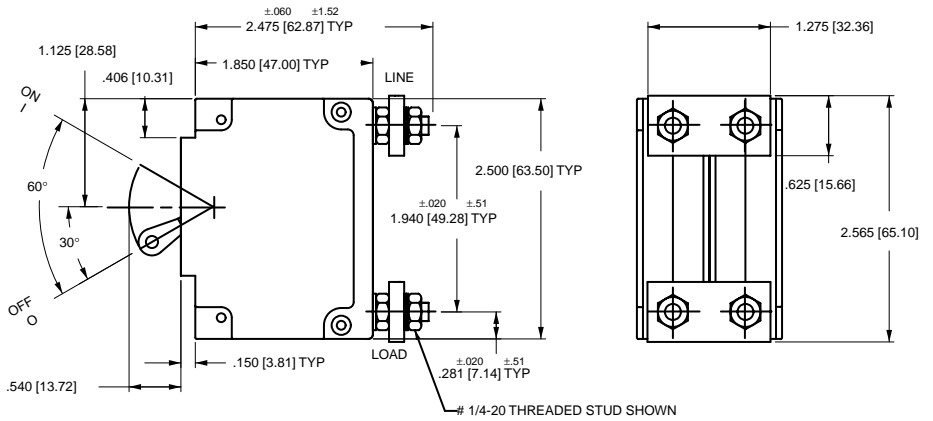
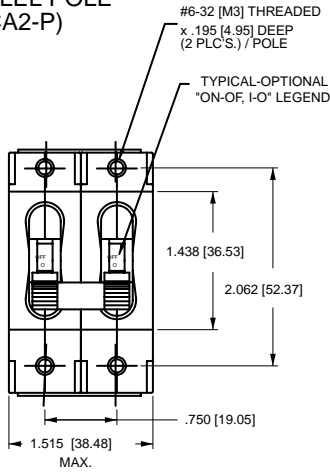

PARALLEL POLE (CA3-P)

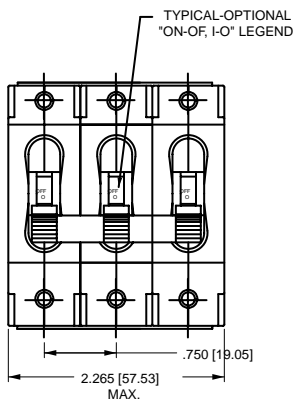

CIRCUIT BREAKER PROFILE	CIRCUIT SCHEMATIC		CIRCUIT CODE	AUX SWITCH CODE
	ANSI	IEC		
	SERIES TRIP 		P	0
PUSH-IN STUD 	SERIES TRIP WITH AUXILIARY SWITCH 		P	2 3 4

TERMINAL DETAILS

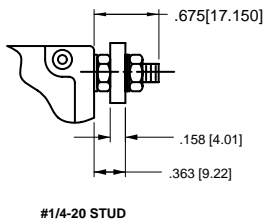
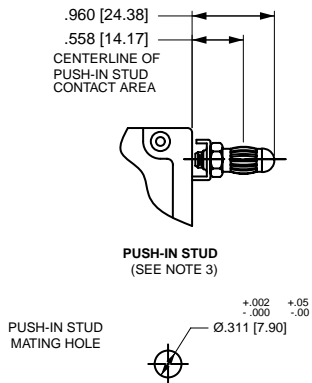

PANEL CUTOUT DETAIL

TOLERANCES ±.005 [.12]

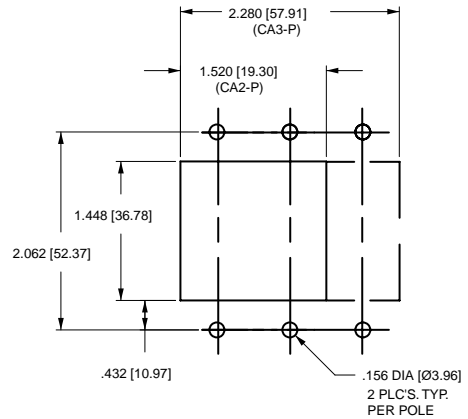

Notes:

- 1 All dimensions are in inches [millimeters].
- 2 Tolerance ±.010 [.25] unless otherwise specified.
- 3 Line and Load terminals must be paralleled with copper bus with a minimum cross section of .078 square inches [50.32 sq. mm.].

CIRCUIT BREAKER PROFILE	CIRCUIT SCHEMATIC		CIRCUIT CODE	AUX SWITCH CODE	CIRCUIT SCHEMATIC		CIRCUIT CODE	AUX SWITCH CODE
	ANSI	IEC			ANSI	IEC		
<p>SERIES TRIP (2 TERMS.)</p>	<p>SWITCH ONLY (NO COIL)</p>		A	0	<p>SWITCH TRIP</p>		BC	0
<p>SERIES TRIP W/AUX. SWITCH (5 TERMS.)</p>	<p>SWITCH ONLY (NO COIL) WITH AUXILIARY SWITCH</p>		A	2 3 4	<p>SERIES TRIP WITH AUXILIARY SWITCH</p>		BC	2 3 4
<p>SHUNT TRIP (3 TERMS.)</p>	<p>SHUNT TRIP</p>		DE	0	<p>DUAL COIL; SERIES TRIP CURRENT COIL, SHUNT TRIP VOLTAGE COIL</p>		H	0
<p>SHUNT TRIP (4 TERMS.)</p>	<p>RELAY TRIP</p>		FG	0	<p>DUAL COIL; SERIES TRIP CURRENT COIL, RELAY TRIP VOLTAGE COIL</p>		K	0

TIGHTENING TORQUE SPECIFICATIONS	
THREAD SIZE	TORQUE
#6-32 [M3] MOUNTING INSERTS	7-9 IN-LBS [0.8-1.0] NM
#10-32 & M5 THD STUDS	15-20 IN-LBS [1.7-2.3] NM
#10-32 & M5 THD SCREW	15-20 IN-LBS [1.7-2.3] NM
#1/4-20 & M6 THD STUDS	30-35 IN-LBS [3.4-4.0] NM

Notes:
 1 All dimensions are in inches [millimeters].
 2 Tolerance ± 0.015 [.38] unless otherwise specified.

DESCRIPTION	CODE	DIMENSIONAL DETAIL	RATING (AMPS)		
			25	50	100
#10-32 STUD	1				
M5 STUD	4				
#1/4-20 STUD	3				
M6 STUD	6				
#10-32 SCREW	2				
M-5 SCREW	5				
.250 DOUBLE Q.C.	7				
1/4" CLIP TERMINALS	8				
PUSH-IN STUD	A				

NOTE: TOLERANCE ON STUD LENGTHS IS ±.031 [±.79] UNLESS OTHERWISE SPECIFIED

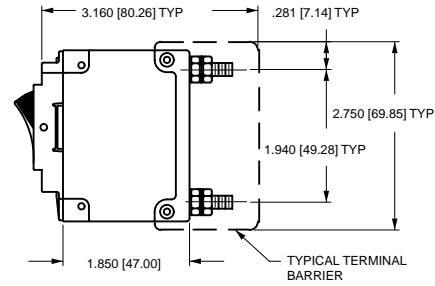

STUD TERMINAL VERSION IS SUPPLIED WITH 2 HEX NUTS AND FLAT WASHERS / TERMINAL SCREW TERMINAL VERSION IS SUPPLIED WITH #10-32 SCREW, FLAT WASHER AND SADDLE CLAMP / TERMINAL. THE SADDLE CLAMP IS FOR DIRECT WIRE CONNECTION USE. DISCARD SADDLE CLAMP IF WIRE TERMINAL LUG IS USED

AUXILIARY / ALARM SWITCH TERMINAL DETAIL³

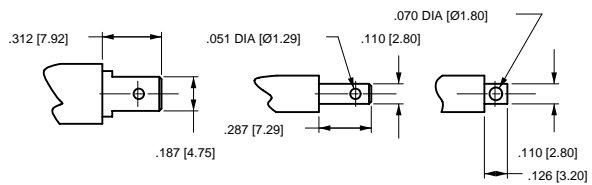

TAB (Q.C.) .187 TAB (Q.C.) .110 SOLDER TYPE

- NOTES:
1. ALL DIMENSIONS ARE IN INCHES [mm]
 2. TOLERANCE ±.020 [.51] UNLESS OTHERWISE SPECIFIED.
 3. AVAILABLE ON SERIES TRIP AND SWITCH ONLY CIRCUITS WHEN CALLED FOR ON MULTI-POLE UNITS, ONLY ONE AUX. SWITCH IS NORMALLY SUPPLIED, AS VIEWED IN MULTI-POLE IDENTIFICATION SCHEME.

TIGHTENING TORQUE SPECIFICATIONS	
THREAD SIZE	TORQUE
#6-32 [M3] MOUNTING INSERTS	7-9 IN-LBS
#10-32 & M5 THD STUDS	15-20 IN-LBS
#10-32 & M5 THD SCREW	15-20 IN-LBS
#1/4-20 & M6 THD STUDS	30-35 IN-LBS

- Notes:
- 1 All dimensions are in inches [millimeters].
 - 2 Tolerance ±.010 [.25] unless otherwise specified.

INDICATE "ON"

SCREW TYPE TERMINALS IN SERIES TRIP CIRCUIT CONFIGURATION SHOWN. FOR OTHER CONFIGURATIONS SEE CIRCUIT AND TERM. DIAGRAMS

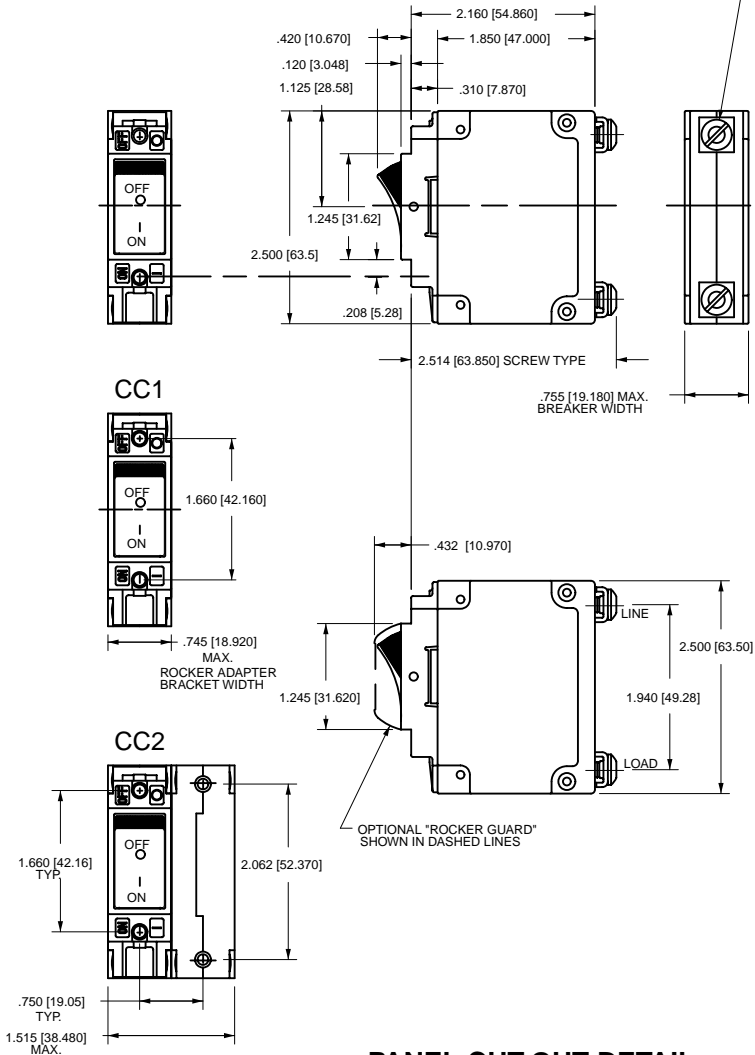

INDICATE "OFF" & SINGLE COLOR
(INDICATE "OFF" SHOWN)

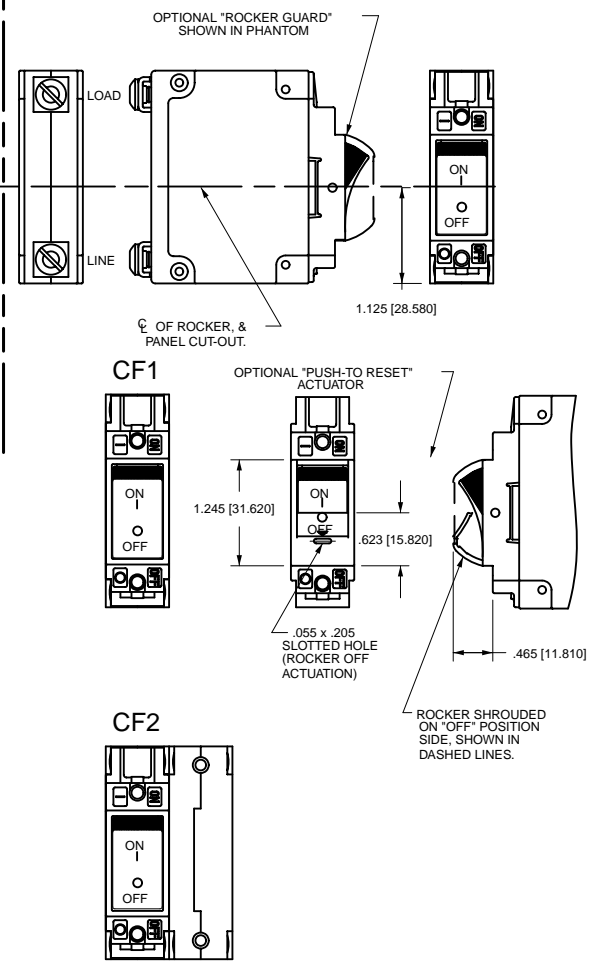

PANEL CUT-OUT DETAIL

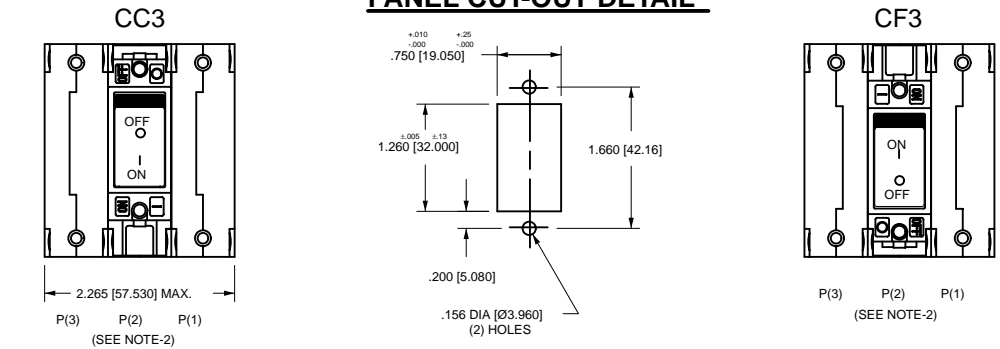

- Notes:
- 1 Dimensions apply to all variations shown. Notice that circuit breaker line and load terminal orientation on indicate OFF is opposite of indicate ON.
 - 2 For pole orientation with horizontal legend, rotate front view clockwise 90°.
 - 3 All dimensions are in inches [millimeters].
 - 4 Tolerance ±.015 [.38] unless otherwise specified.