

5

4

3

2

1

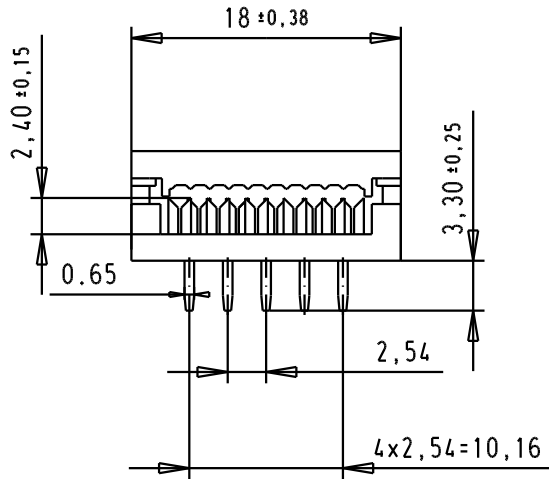
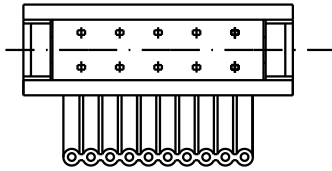
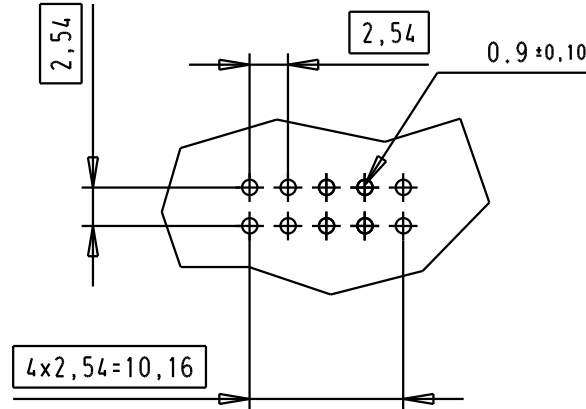

Printed board layout, component side

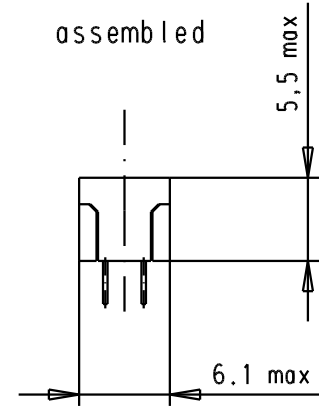
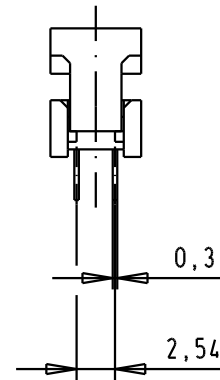

pre assembled

assembled



						 All Dim. in mm Orig. Size DIN A 4	SEK 18, P.C.B Transition 10 poles connector 2 rows - Low Profile	Maßstab/ Scale 2:1	
				Detail.	02/04/04				JH
				Insp.					
				Stand.					
				31884	02/04/04	JH	 TB 09181109622	Blatt/ Page 1 /	
				Mod.	Del.	Name			HARTING EURL F-95972 Paris Sub.

D

C

B

A