

5mm × 5mm 0.2W SMD Type

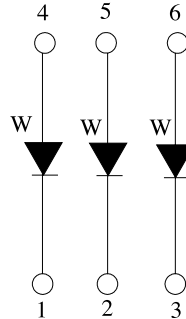

Package Dimensions:

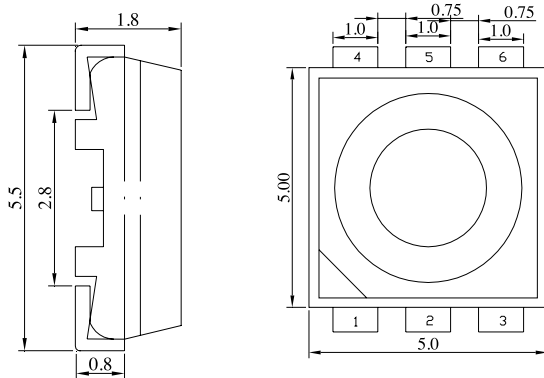

All dimensions are in mm
Tolerance: ±0.25mm

Absolute Maximum Ratings at Ta=25°C

Parameter	Symbol	Rating	Unit
Power Dissipation*	P _D	120	mW
Reverse Voltage*	V _R	5	V
D.C. Forward Current*	I _f	30	mA
Pulsed Forward Current (1 / 10 Duty Cycle, 0.1ms Pulse Width)*	I _f (Peak)	100	mA
Operating Temperature Range	T _{opr.}	-40 to +100	°C
Storage Temperature Range	T _{stg.}	-40 to +100	°C
Soldering Temperature	T _{sld.}	Reflow Soldering: 260°C for 10sec. Hand Soldering: 350°C for 3sec.	
Electric Static Discharge Threshold (HBM)	ESD	6,000	V

* The values are based on 1 die performance.

Electrical & Optical Characteristics:

Parameter	Symbol	Condition	Min.	Typ.	Max.	Unit	
Luminous Intensity* ²	I _v	I _f = 20mA* ¹	2,750	6,020	-	mcd	
Luminous Flux* ²	Φ _v	I _f = 20mA* ¹	-	13,700	-	lm	
Forward Voltage* ¹	V _f	I _f = 20mA* ¹	-	3.2	4	V	
Correlated Colour Temperature* ²	WA	CCT	I _f = 20mA* ¹	5,000	-	5,250	K
	WB			5,250	-	5,500	
	WC			5,500	-	5,750	
	WD			5,750	-	6,000	
Colour Rendering Index (Ra)	CRI	I _f = 20mA* ¹	-	64	-	Ra	
Reverse Current* ¹	I _r	V _r = 5V	-	-	50	μA	
Viewing Angle* ²	2θ ½	I _f = 20mA* ¹	-	120	-	deg	

- Notes: 1. The data is tested by an IS tester.
 2. Customer's special requirements are also welcome.
 3. *¹ For each die.
 4. *² When all LED dies are operated simultaneously.



5mm × 5mm 0.2W SMD Type



Typical Electrical & Optical Characteristics Curves:

(25°C Ambient temperature unless otherwise noted)

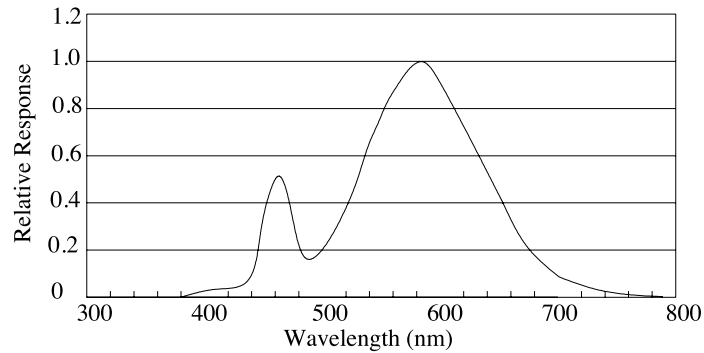
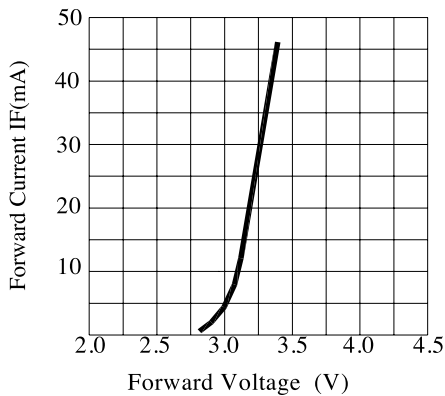
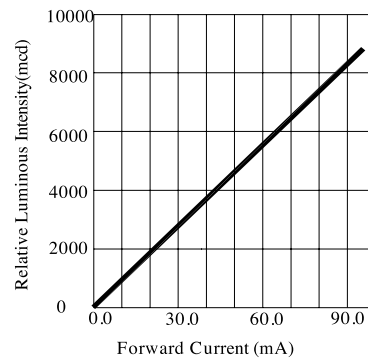

Fig.1 WHITE LED Spectrum VS. WAVELENGTH



Forward Current VS. Applied Voltage



Forward Current VS. Luminous Intensity

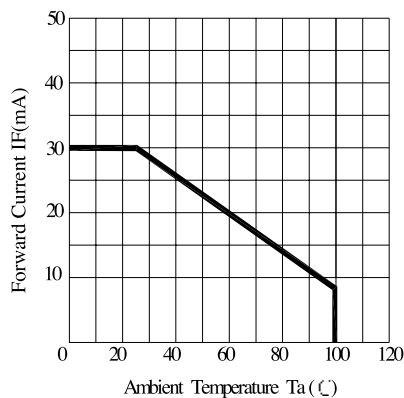

Ambient Temperature VS. Forward Current

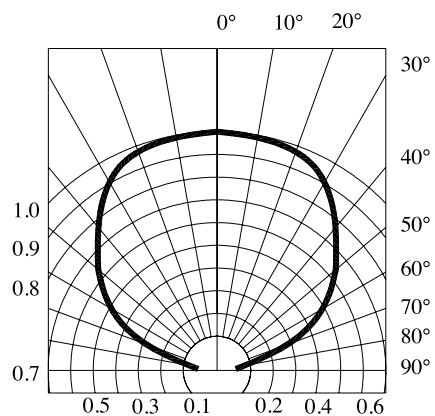

Radiation Diagram

5mm × 5mm 0.2W SMD Type



Recommended Storage Environment:

- Temperature: 5°C to 30°C (41°F to 86°F)
- Humidity: 60% RH Max.
- Use within 7 days after opening of sealed vapour/ESD barrier bags

If moisture absorbent material (silica gel) has faded away or LEDs have exceeded the storage time, baking treatment should be performed using the following conditions:

- Baking Treatment : 60 ± 5°C for 24 hours
- Fold the opened bag firmly and keep in dry environment

Soldering

Reflow Soldering			Hand Soldering	
	Lead Solder	Lead-free Solder		
Pre-heat	12°C ~ 150°C	180°C ~ 200°C	Temperature	350°C Max.
Pre-heat Time	120sec. max.	120sec. max	Soldering Time	3sec. Max (one time only)
Peak Temperature	240°C max.	260°C max.		
Soldering Time	10sec max.	10sec. max		
Condition	Refer to Temperature Profile 1	Refer to Temperature Profile 2		

*After reflow soldering rapid cooling should be avoided.

Temperature-profile (surface of circuit board)

Use the conditions shown under figure.

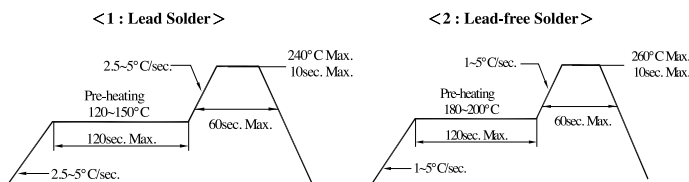

Recommended Soldering Pad Design

Use the conditions shown under figure.

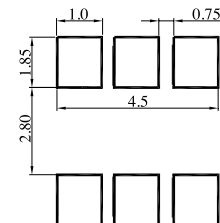

Part Number Table

LED Chip		Lens Colour	Part Number
Material	Emitting Colour		
InGaN / Sapphire	White	Yellow diffused	703-1040

Important Notice : This data sheet and its contents (the "Information") belong to the members of the Premier Farnell group of companies (the "Group") or are licensed to it. No licence is granted for the use of it other than for information purposes in connection with the products to which it relates. No licence of any intellectual property rights is granted. The Information is subject to change without notice and replaces all data sheets previously supplied. The Information supplied is believed to be accurate but the Group assumes no responsibility for its accuracy or completeness, any error in or omission from it or for any use made of it. Users of this data sheet should check for themselves the Information and the suitability of the products for their purpose and not make any assumptions based on information included or omitted. Liability for loss or damage resulting from any reliance on the Information or use of it (including liability resulting from negligence or where the Group was aware of the possibility of such loss or damage arising) is excluded. This will not operate to limit or restrict the Group's liability for death or personal injury resulting from its negligence. Multicomp is the registered trademark of the Group. © Premier Farnell plc 2012.

