

PLEASE CHECK WWW.MOLEX.COM FOR LATEST PART INFORMATION

Part Number: **502380-0600**
Status: **Active**
Overview: CLIK-Mate™ Wire-to-Board Connectors
Description: 1.25mm Pitch CLIK-Mate™ Wire-to-Board Housing, Single Row, Positive Lock, 6 Circuits

Documents:

3D Model	Application Specification AS-502380-001 (PDF)
Drawing (PDF)	Application Specification AS-502380-002 (PDF)
Product Specification PS-502382-001 (PDF)	RoHS Certificate of Compliance (PDF)

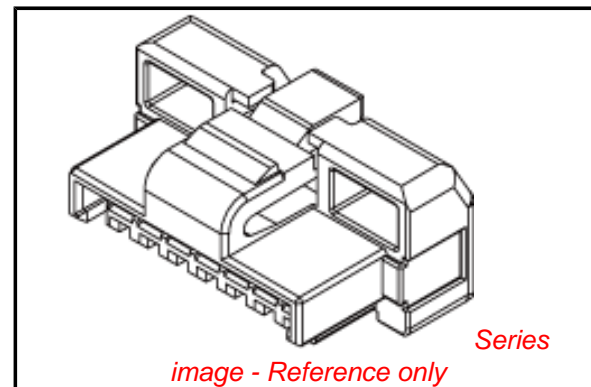

General

Product Family	Crimp Housings
Series	502380
Application	Signal, Wire-to-Board
MolexKits	Yes
Overview	<u>CLIK-Mate™ Wire-to-Board Connectors</u>
Product Name	CLIK-Mate™

Physical

Breakaway	No
Circuits (maximum)	6
Color - Resin	White
Gender	Plug
Glow-Wire Compliant	No
Keying to Mating Part	Yes
Lock to Mating Part	Yes
Material - Resin	Polyester
Number of Rows	1
Packaging Type	Bag
Panel Mount	No
Pitch - Mating Interface	1.25mm
Polarized to Mating Part	Yes
Stackable	No
Temperature Range - Operating	-25°C to +85°C

Electrical

Current - Maximum per Contact	1A
-------------------------------	----

Material Info

UPC	822350894883
-----	--------------

Reference - Drawing Numbers

Application Specification	AS-502380-001, AS-502380-002
Product Specification	PS-502382-001, RPS-502382-003, RPS-502382-004, RPS-502382-005, RPS-502382-006, RPS-502382-008, RPS-502382-010, RPS-502382-011, RPS-502382-012, RPS-502382-013, RPS-502382-016, RPS-502382-017, RPS-502386-001, RPS-502386-002
Sales Drawing	SD-502380-001, SD-502380-002

EU RoHS

ELV and RoHS Compliant
REACH SVHC Contains SVHC: No
Low-Halogen Status Not Reviewed

China RoHS



Need more information on product environmental compliance?

Email productcompliance@molex.com
 For a multiple part number RoHS Certificate of Compliance, [click here](#)

Please visit the [Contact Us](#) section for any non-product compliance questions.

Search Parts in this Series

502380Series

Mates With

502382 PCB Receptacle, 502386 PCB Receptacle

Use With

502381 Crimp Terminal