

PLEASE CHECK WWW.MOLEX.COM FOR LATEST PART INFORMATION

Part Number: [52207-0960](#)
Status: **Active**
Overview: FFC-FPC (SMT)
Description: 1.00mm Pitch FFC/FPC Connector, SMT, Right Angle, ZIF, Top Contact Style Receptacle, 9 Circuits, Lead-Free, Gold Contact Plating, High Barrier Packaging

Documents:

[3D Model](#) [Packaging Specification SPK-52207-002 \(PDF\)](#)
[Drawing \(PDF\)](#) [RoHS Certificate of Compliance \(PDF\)](#)
[Product Specification PS-52207-048 \(PDF\)](#)

Agency Certification

CSA LR19980
 UL E29179

General

Product Family FFC/FPC Connectors
 Series [52207](#)
 Overview [FFC-FPC \(SMT\)](#)
 Product Name N/A

Physical

Circuits (Loaded) 9
 Color - Resin Natural
 Contact Position Top
 Durability (mating cycles max) 30
 Entry Angle 90° Angle
 Flammability 94V-0
 Mated Height 2.70mm
 Material - Metal Phosphor Bronze
 Material - Plating Mating Gold
 Material - Plating Termination Tin
 Material - Resin Nylon
 Number of Rows 1
 Orientation Right Angle
 PC Tail Length 2.00mm
 PCB Locator No
 PCB Retention Yes
 Packaging Type Embossed Tape on Reel
 Pitch - Mating Interface 1.00mm
 Pitch - Termination Interface 1.00mm
 Polarized to PCB Yes
 Stackable No
 Temperature Range - Operating -30°C to +85°C
 Termination Interface: Style Surface Mount
 Wire/Cable Type FFC/FPC

Electrical

Current - Maximum per Contact 1A
 Voltage - Maximum 125V

Material Info

Reference - Drawing Numbers

[Packaging Specification](#) SPK-52207-002
[Product Specification](#) PS-52207-048, RPS-52207-073, RPS-52207-075,
 RPS-52207-078, RPS-52207-084, RPS-52207-090,

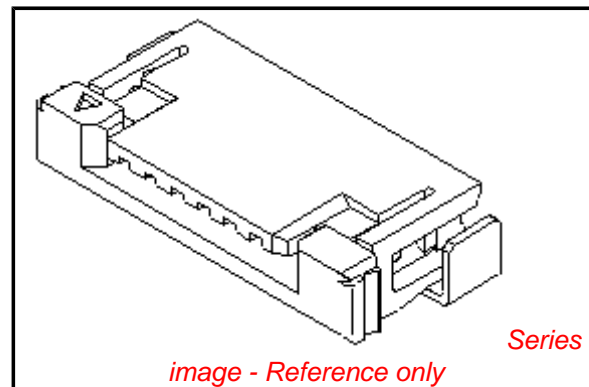

image - Reference only

EU RoHS

**ELV and RoHS
 Compliant**
**REACH SVHC
 Contains SVHC: No
 Low-Halogen Status
 Not Low-Halogen**

China RoHS



**Need more information on product
 environmental compliance?**

Email productcompliance@molex.com
 For a multiple part number RoHS Certificate of Compliance, [click here](#)

Please visit the [Contact Us](#) section for any non-product compliance questions.

Search Parts in this Series
[52207Series](#)

Sales Drawing

RPS-52207-092, RPS-52207-094, RPS-52207-099,
RPS-52207-101, RPS-52207-106
SD-52207-064, SD-52207-065

This document was generated on 03/30/2012

PLEASE CHECK WWW.MOLEX.COM FOR LATEST PART INFORMATION