

PLEASE CHECK WWW.MOLEX.COM FOR LATEST PART INFORMATION

Part Number: [501331-0907](#)
Status: **Active**
Overview: [Pico-Clasp™](#)
Description: 1.00mm Pitch Pico-Clasp™ Wire-to-Board Header, Surface Mount, Single Row, Vertical, with Positive Lock, 9 Circuits, with Cover Tape, Lead-Free

Documents:

[3D Model](#) [Packaging Specification SPK-501331-001 \(PDF\)](#)
[Drawing \(PDF\)](#) [RoHS Certificate of Compliance \(PDF\)](#)
[Product Specification PS-501331-001 \(PDF\)](#)

General

Product Family	PCB Headers
Series	501331
Application	Signal, Wire-to-Board
Overview	Pico-Clasp™
Product Name	Pico-Clasp™

Physical

Breakaway	No
Circuits (Loaded)	9
Color - Resin	Natural
Durability (mating cycles max)	30
Glow-Wire Compliant	No
Lock to Mating Part	Yes
Material - Metal	Phosphor Bronze
Material - Plating Mating	Tin
Material - Plating Termination	Tin
Material - Resin	Nylon
Number of Rows	1
Orientation	Vertical
PCB Locator	No
PCB Retention	Yes
Packaging Type	Embossed Tape on Reel
Pitch - Mating Interface	1.00mm
Polarized to Mating Part	Yes
Polarized to PCB	No
Robotic Placement	Vacuum Pick-Up Tape
Stackable	No
Temperature Range - Operating	-40°C to +85°C
Termination Interface: Style	Surface Mount

Electrical

Current - Maximum per Contact	1A
Voltage - Maximum	50V AC (RMS)/DC

Material Info

Reference - Drawing Numbers

Packaging Specification	SPK-501331-001
Product Specification	PS-501331-001, RPS-501331-001, RPS-501331-002, RPS-501331-003, RPS-501331-005, RPS-501331-006, RPS-501331-007, RPS-501331-009, RPS-501940-001, RPS-501940-002
Sales Drawing	SD-501331-002, SD-501331-004

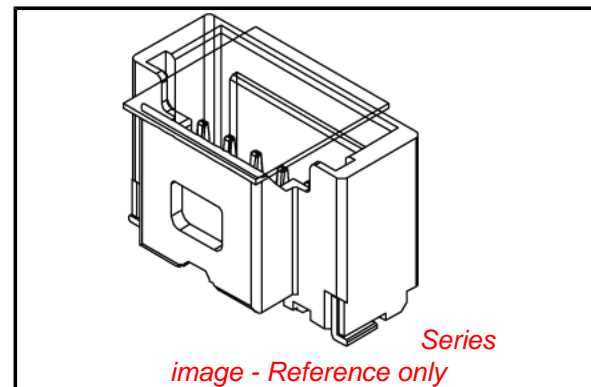

EU RoHS

ELV and RoHS Compliant
REACH SVHC
Contains SVHC: No
Low-Halogen Status
Not Low-Halogen

China RoHS



Need more information on product environmental compliance?

Email productcompliance@molex.com
 For a multiple part number RoHS Certificate of Compliance, [click here](#)

Please visit the [Contact Us](#) section for any non-product compliance questions.

Search Parts in this Series

[501331Series](#)

Mates With

[501330 Pico-Clasp™ Wire-to-Board Female Housing](#)

This document was generated on 05/01/2012

PLEASE CHECK WWW.MOLEX.COM FOR LATEST PART INFORMATION