

Elco Europe (A Division of AVX Ltd) CONFIDENTIAL PROPRIETY
 The document on this print and information therewith are PROPRIETY
 to Elco Europe (A Division of AVX Ltd) and shall not be copied
 or disclosed in whole or in part without Elco Europe's written consent.

24-9159-XXX-1X2-XX6

PREFIX

CODE	TYPE
24	RIGHT ANGLE WIRED SOCKET IDC TERMINATIONS

SERIES

NO. OF WAYS

CODE	NO. OF WAYS	DETAILS
002	2	SHEET 2&7
003	3	SHEET 3&8
004	4	SHEET 4&9
005	5	SHEET 5&10
006	6	SHEET 6&11



2 PART PCB STRIP CONNECTOR

CODE	DESCRIPTION
1	2 PART WIRED IDC STRIP CONNECTOR

WIRE GAUGE

CODE	WIRE GAUGE
2	22AWG
3	24AWG

WIRE INSULATION DIAMETER

CODE	WIRE INSULATION SIZE RANGE
2	Ø1.10mm TO Ø1.60mm

COLOUR OPTIONS

CODE	COLOUR	AVAILABILITY
0	BLACK	SPECIAL ORDER
1	WHITE	STANDARD
8	BLACK	UL APPROVED - SPECIAL ORDER
9	WHITE	UL APPROVED - SPECIAL ORDER

CAP OPTIONS

CODE	CAP OPTION	AVAILABILITY
0	THROUGH WIRE	ALLOWS WIRES TO BE TERMINATED AT ANY POINT
9	WIRE STOP	TERMINATES END OF WIRE END PROTECTED WITH STOP FACE

PLATING OPTION

CODE	CONTACT
6	GOLD ON CONTACT, TIN ON IDC



SHEET 1 OF 14

FORM-106-01-056-6 ISS 7

Release No.	History
102727	21.07.2011
102844	05.12.2011
102862	09.01.2012
	23.01.2012
	13.03.2012

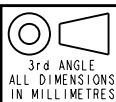

ELCO
 © COPYRIGHT ELCO EUROPE
 NOT TO BE DISCLOSED OR COPIED
 WITHOUT WRITTEN PERMISSION

Drawn	Size
N.C.H.	CV

Description	Part Number
9159 TWO PART - ORDERING CODE	24-9159-01_100S

DATE	Issue
01-July-11	3

A

B

**SOCKET - WIRED - 2 WAY
THROUGH WIRE CAP**

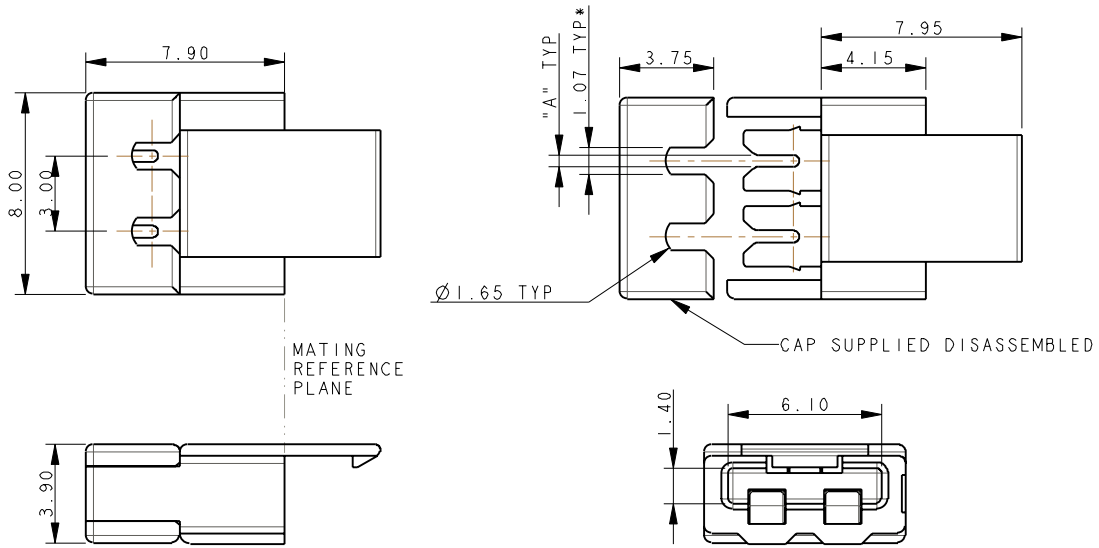

WIRE GAUGE	CODE (SHEET 1)	DIMENSION "A"	WIRE INSULATION DIAMETER
22AWG (STRANDED WIRE)	122	0.47	1.10 TO 1.60
24AWG (STRANDED WIRE)	132	0.37	1.10 TO 1.60

NOTES:

- FOR MORE INFORMATION REFER TO PRODUCT SPEC 201-01-119. FOR WIRE ASSEMBLY REFER TO APPLICATION NOTES 201-01-123.
- THROUGH WIRE CAP, FOR TERMINATION OF WIRE IN ANY POSITION.
- CAP ACTS AS WIRE ASSEMBLY TOOL. *WIRE PREFIT TO CAP, NARROW SLOT TO GRIP WIRE. PERMANENT ASSEMBLY.
- GENERAL TOLERANCE ± 0.20 UNLESS SPECIFIED..
- INSULATOR MATERIAL :- NYLON 46, GLASS FILLED, UL94 V-0, COLOUR REFER TO SHEET 1.
- CONTACT MATERIAL :- COPPER ALLOY, PLATING NICKEL BASE ALL OVER, GOLD ON CONTACT, TIN ON IDC.
- PACKING IN TAPE AND REEL. QTY PER REEL 700, POCKET CONTAINS 1 CONNECTOR AND 1 CAP.
- WIRE GAUGE OPTIONS, SEE TABLE.
- ASSEMBLY AIDS, REFER TO SHEETS 12 AND 13.

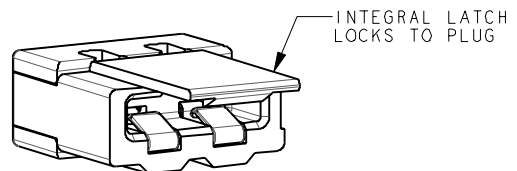
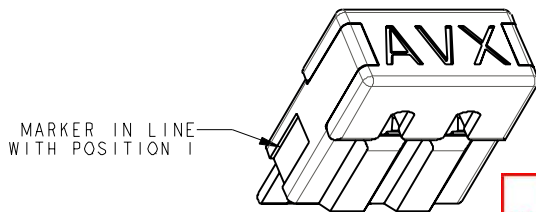

Elco Europe (A Division of AVX Ltd) CONFIDENTIAL PROPRIETY
The document on this print and information therewith are PROPRIETY
to Elco Europe (A Division of AVX Ltd) and shall not be copied
or disclosed in whole or in part without Elco Europe's written consent.

PACKING DETAILS
CAP AND CONNECTOR SUPPLIED TOGETHER (TWO PARTS)

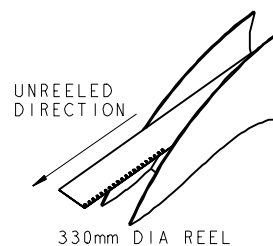
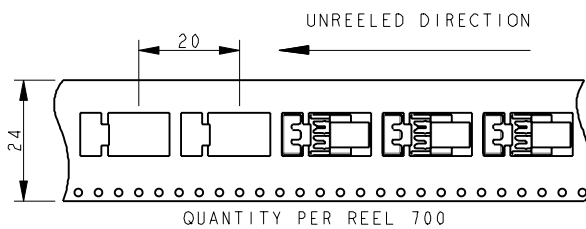

SHEET 2 OF 14

FORM-106-01-056-6 ISS 7

Release No.	102727
History	21.07.2011
	25.08.2011
	05.12.2011
	09.01.2012
	102844
	23.01.2012
	102862
	13.03.2012

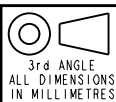

ELCO
 © COPYRIGHT ELCO EUROPE
 NOT TO BE DISCLOSED OR COPIED
 WITHOUT WRITTEN PERMISSION

Drawn	N.C.H.
Size	CV

Description	9159 TWO PART - ORDERING CODE
Part Number	24-9159-01_100S

DATE	01-July-11
Issue	3

A

B

SOCKET - WIRED - 3 WAY THROUGH WIRE CAP

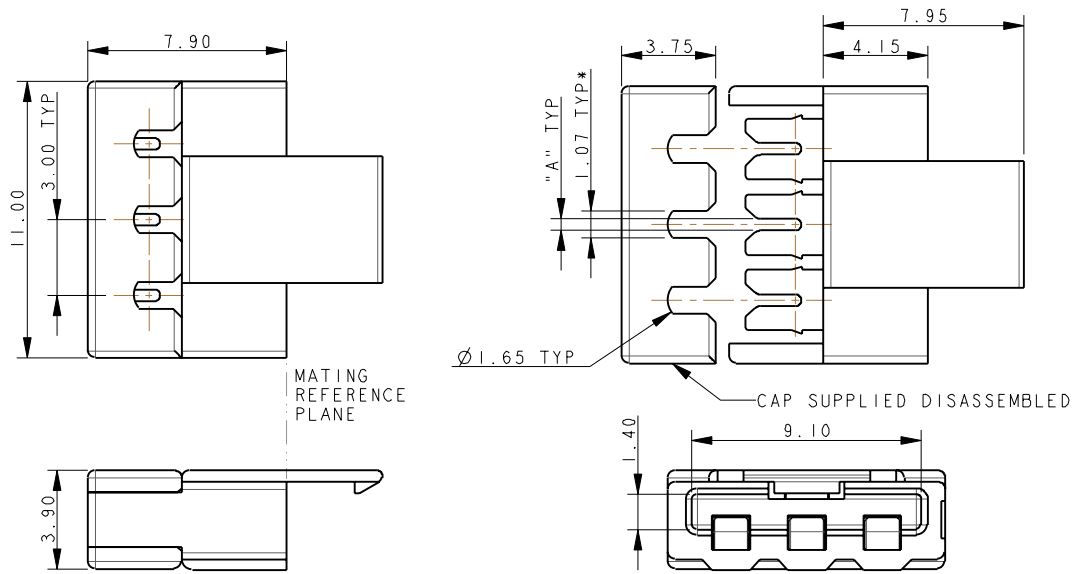

WIRE GAUGE	CODE (SHEET 1)	DIMENSION "A"	WIRE INSULATION DIAMETER
22AWG (STRANDED WIRE)	122	0.47	1.10 TO 1.60
24AWG (STRANDED WIRE)	132	0.37	1.10 TO 1.60

NOTES:

- FOR MORE INFORMATION REFER TO PRODUCT SPEC 201-01-119. FOR WIRE ASSEMBLY REFER TO APPLICATION NOTES 201-01-123.
- THROUGH WIRE CAP, FOR TERMINATION OF WIRE IN ANY POSITION.
- CAP ACTS AS WIRE ASSEMBLY TOOL. *WIRE PREFIT TO CAP, NARROW SLOT TO GRIP WIRE. PERMANENT ASSEMBLY.
- GENERAL TOLERANCE ± 0.20 UNLESS SPECIFIED..
- INSULATOR MATERIAL :- NYLON 46, GLASS FILLED, UL94 V-0, COLOUR REFER TO SHEET 1.
- CONTACT MATERIAL :- COPPER ALLOY, PLATING NICKEL BASE ALL OVER, GOLD ON CONTACT, TIN ON IDC.
- PACKING IN TAPE AND REEL. QTY PER REEL 700, POCKET CONTAINS 1 CONNECTOR AND 1 CAP.
- WIRE GAUGE OPTIONS, SEE TABLE.
- ASSEMBLY AIDS, REFER TO SHEETS 12 AND 13.

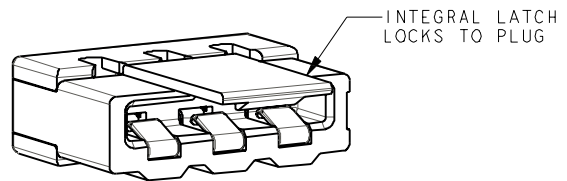
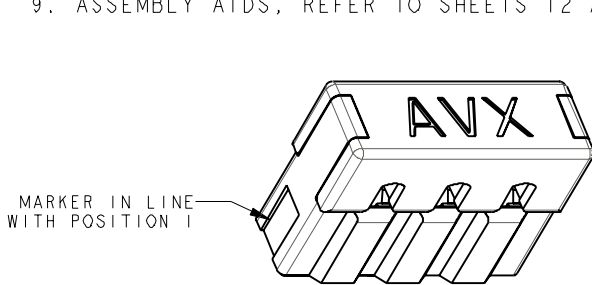

Elco Europe (A Division of AVX Ltd) CONFIDENTIAL PROPRIETY
The document on this print and information therewith are PROPRIETY
to Elco Europe (A Division of AVX Ltd) and shall not be copied
or disclosed in whole or in part without Elco Europe's written consent.

PACKING DETAILS CAP AND CONNECTOR SUPPLIED TOGETHER (TWO PARTS)

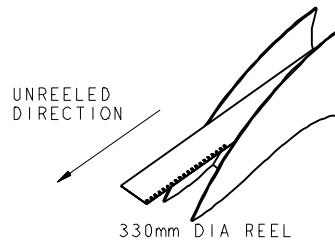
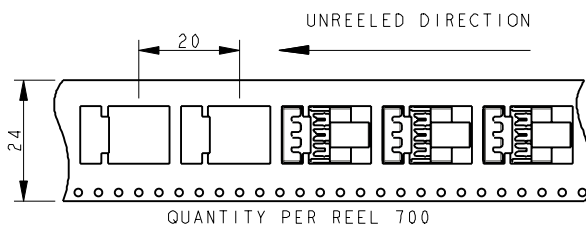

SHEET 3 OF 14

FORM-106-01-056-6 ISS 7

Release No.	102727
History	21.07.2011
	25.08.2011
	05.12.2011
	09.01.2012
	102844
	23.01.2012
	102862
	13.03.2012

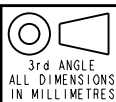

ELCO
© COPYRIGHT ELCO EUROPE
NOT TO BE DISCLOSED OR COPIED
WITHOUT WRITTEN PERMISSION

Drawn
N.C.H.
Size
CV

Description
9159 TWO PART - ORDERING CODE
Part Number
24-9159-01_100S

DATE
01-July-11
Issue
3

A

B

SOCKET - WIRED - 4 WAY THROUGH WIRE CAP

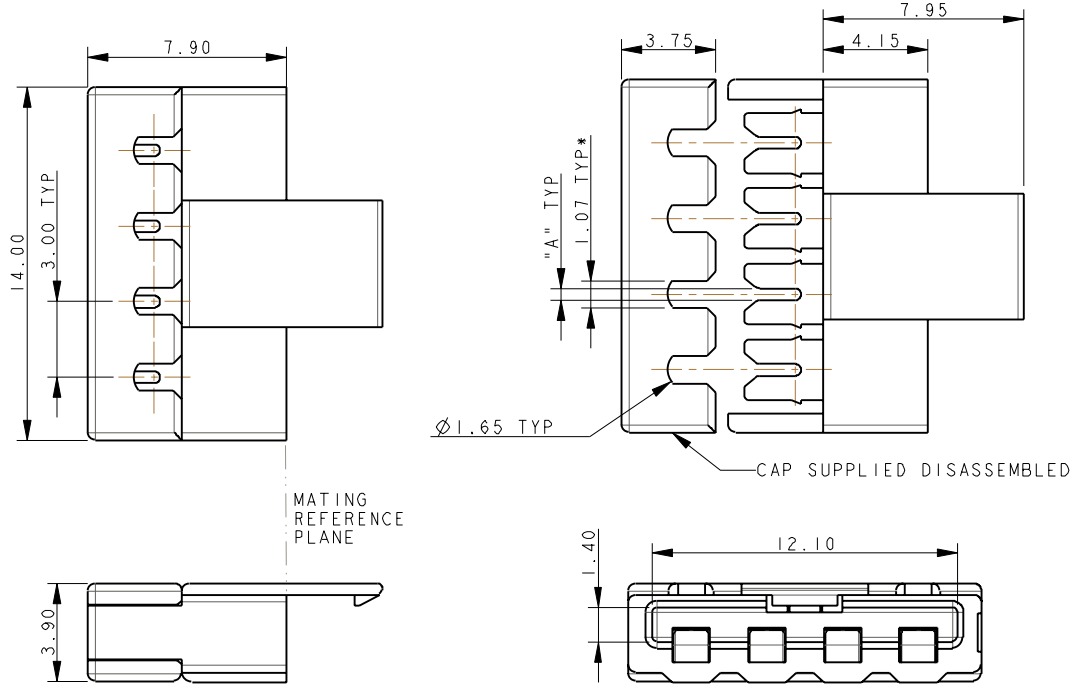

WIRE GAUGE	CODE (SHEET 1)	DIMENSION "A"	WIRE INSULATION DIAMETER
22AWG (STRANDED WIRE)	122	0.47	1.10 TO 1.60
24AWG (STRANDED WIRE)	132	0.37	1.10 TO 1.60

NOTES:

- FOR MORE INFORMATION REFER TO PRODUCT SPEC 201-01-119. FOR WIRE ASSEMBLY REFER TO APPLICATION NOTES 201-01-123.
- THROUGH WIRE CAP, FOR TERMINATION OF WIRE IN ANY POSITION.
- CAP ACTS AS WIRE ASSEMBLY TOOL. *WIRE PREFIT TO CAP, NARROW SLOT TO GRIP WIRE. PERMANENT ASSEMBLY.
- GENERAL TOLERANCE ± 0.20 UNLESS SPECIFIED..
- INSULATOR MATERIAL :- NYLON 46, GLASS FILLED, UL94 V-0, COLOUR REFER TO SHEET 1.
- CONTACT MATERIAL :- COPPER ALLOY, PLATING NICKEL BASE ALL OVER, GOLD ON CONTACT, TIN ON IDC.
- PACKING IN TAPE AND REEL. QTY PER REEL 700, POCKET CONTAINS 1 CONNECTOR AND 1 CAP.
- WIRE GAUGE OPTIONS, SEE TABLE.
- ASSEMBLY AIDS, REFER TO SHEETS 12 AND 13.

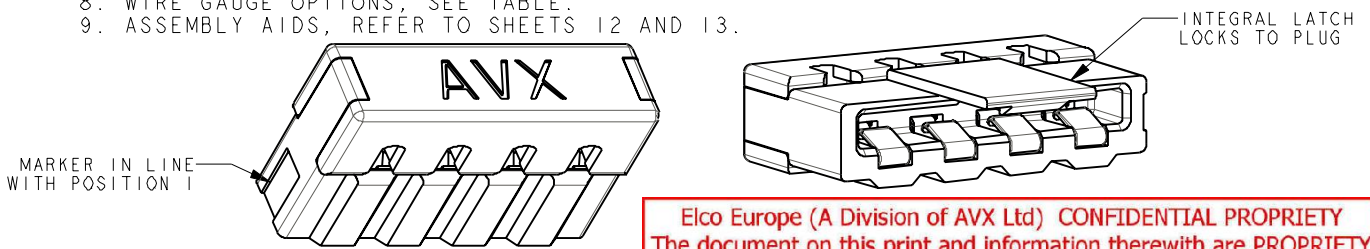

Elco Europe (A Division of AVX Ltd) CONFIDENTIAL PROPRIETY
 The document on this print and information therewith are PROPRIETY to Elco Europe (A Division of AVX Ltd) and shall not be copied or disclosed in whole or in part without Elco Europe's written consent.

PACKING DETAILS CAP AND CONNECTOR SUPPLIED TOGETHER (TWO PARTS)

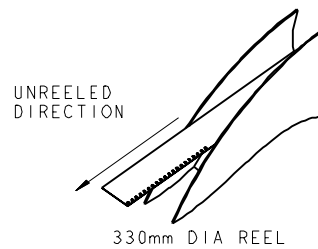
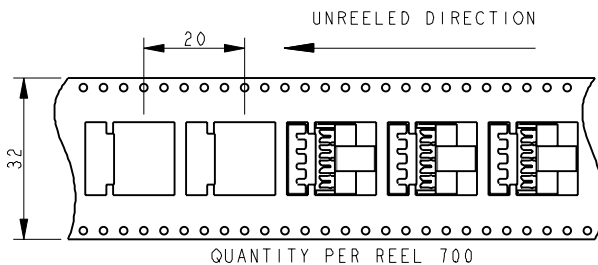

SHEET 4 OF 14

FORM-106-01-056-6 ISS 7

Release No.	102727
History	21.07.2011
	25.08.2011
	05.12.2011
	09.01.2012
	102844
	23.01.2012
	102862
	13.03.2012

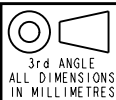

ELCO
 © COPYRIGHT ELCO EUROPE
 NOT TO BE DISCLOSED OR COPIED
 WITHOUT WRITTEN PERMISSION

Drawn	N.C.H.
Size	CV

Description	9159 TWO PART - ORDERING CODE
Part Number	24-9159-01_100S

DATE	01-July-11
Issue	3

A

B

SOCKET - WIRED - 5 WAY THROUGH WIRE CAP

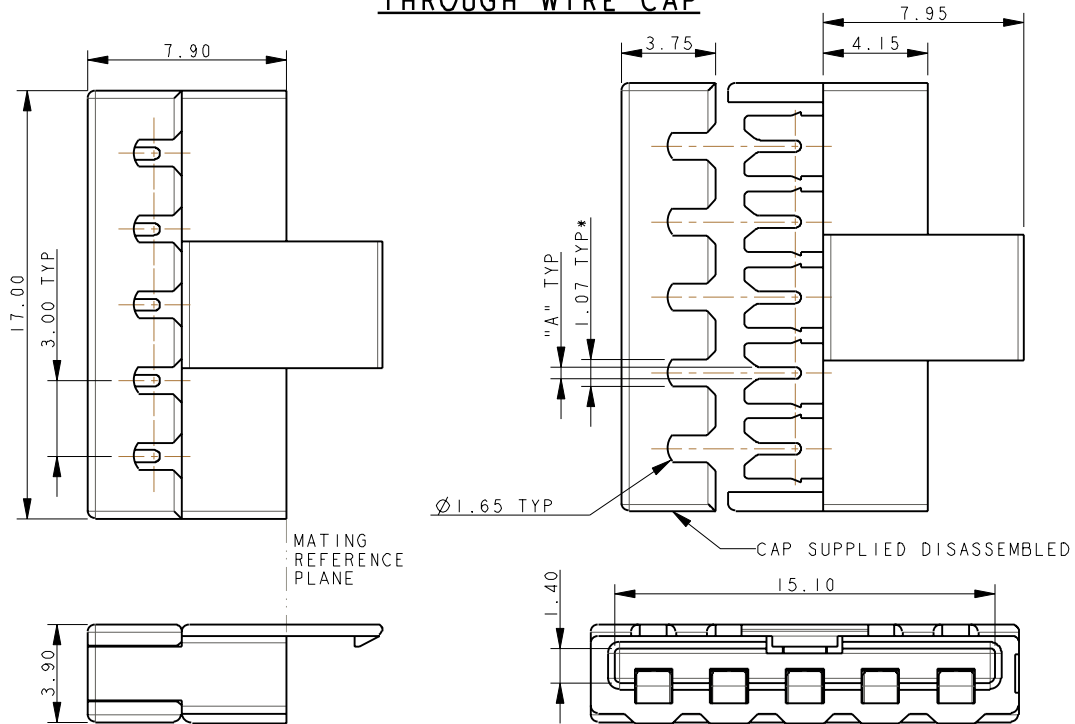

WIRE GAUGE	CODE (SHEET 1)	DIMENSION "A"	WIRE INSULATION DIAMETER
22AWG (STRANDED WIRE)	122	0.47	1.10 TO 1.60
24AWG (STRANDED WIRE)	132	0.37	1.10 TO 1.60

NOTES:

- FOR MORE INFORMATION REFER TO PRODUCT SPEC 201-01-119. FOR WIRE ASSEMBLY REFER TO APPLICATION NOTES 201-01-123.
- THROUGH WIRE CAP, FOR TERMINATION OF WIRE IN ANY POSITION.
- CAP ACTS AS WIRE ASSEMBLY TOOL. *WIRE PREFIT TO CAP, NARROW SLOT TO GRIP WIRE. PERMANENT ASSEMBLY.
- GENERAL TOLERANCE ± 0.20 UNLESS SPECIFIED..
- INSULATOR MATERIAL :- NYLON 46, GLASS FILLED, UL94 V-0, COLOUR REFER TO SHEET 1.
- CONTACT MATERIAL :- COPPER ALLOY, PLATING NICKEL BASE ALL OVER, GOLD ON CONTACT, TIN ON IDC.
- PACKING IN TAPE AND REEL. QTY PER REEL 700, POCKET CONTAINS 1 CONNECTOR AND 1 CAP.
- WIRE GAUGE OPTIONS, SEE TABLE.
- ASSEMBLY AIDS, REFER TO SHEETS 12 AND 13.

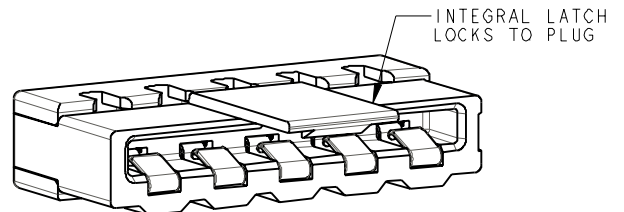
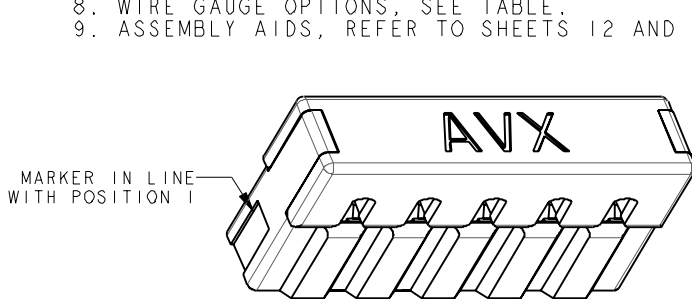

Elco Europe (A Division of AVX Ltd) CONFIDENTIAL PROPRIETY
The document on this print and information therewith are PROPRIETY
to Elco Europe (A Division of AVX Ltd) and shall not be copied
or disclosed in whole or in part without Elco Europe's written consent.

PACKING DETAILS CAP AND CONNECTOR SUPPLIED TOGETHER (TWO PARTS)

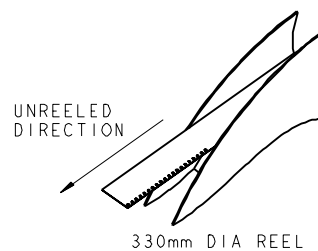
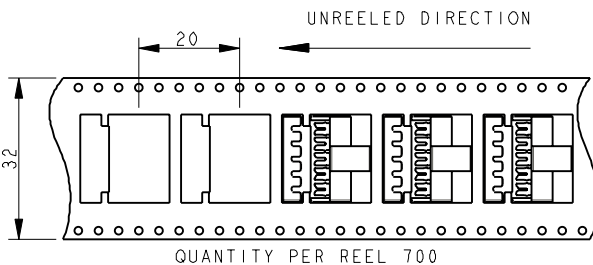

SHEET 5 OF 14

FORM-106-01-056-6 ISS 7

Release No.	102727
History	21.07.2011
	25.08.2011
	05.12.2011
	09.01.2012
	102844
	23.01.2012
	102862
	13.03.2012

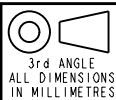

ELCO

© COPYRIGHT ELCO EUROPE
NOT TO BE DISCLOSED OR COPIED
WITHOUT WRITTEN PERMISSION

Drawn
N.C.H.

Size
CV

Description
9159 TWO PART - ORDERING CODE

Part Number
24-9159-01_100S

DATE
01-July-11

Issue
3

A

B

SOCKET - WIRED - 6 WAY THROUGH WIRE CAP

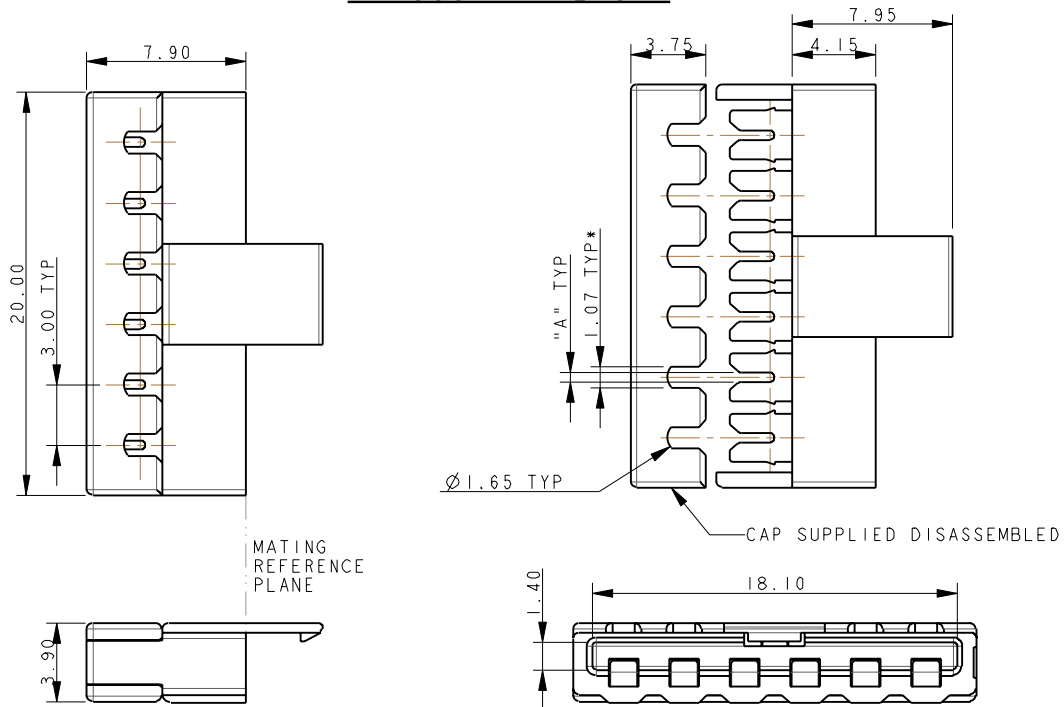

WIRE GAUGE	CODE (SHEET 1)	DIMENSION "A"	WIRE INSULATION DIAMETER
22AWG (STRANDED WIRE)	122	0.47	1.10 TO 1.60
24AWG (STRANDED WIRE)	132	0.37	1.10 TO 1.60

NOTES:

- FOR MORE INFORMATION REFER TO PRODUCT SPEC 201-01-119. FOR WIRE ASSEMBLY REFER TO APPLICATION NOTES 201-01-123.
- THROUGH WIRE CAP, FOR TERMINATION OF WIRE IN ANY POSITION.
- CAP ACTS AS WIRE ASSEMBLY TOOL. *WIRE PREFIT TO CAP, NARROW SLOT TO GRIP WIRE. PERMANENT ASSEMBLY.
- GENERAL TOLERANCE ± 0.20 UNLESS SPECIFIED..
- INSULATOR MATERIAL :- NYLON 46, GLASS FILLED, UL94 V-0, COLOUR REFER TO SHEET 1.
- CONTACT MATERIAL :- COPPER ALLOY, PLATING NICKEL BASE ALL OVER, GOLD ON CONTACT, TIN ON IDC.
- PACKING IN TAPE AND REEL. QTY PER REEL 700, POCKET CONTAINS 1 CONNECTOR AND 1 CAP.
- WIRE GAUGE OPTIONS, SEE TABLE.
- ASSEMBLY AIDS, REFER TO SHEETS 12 AND 13.

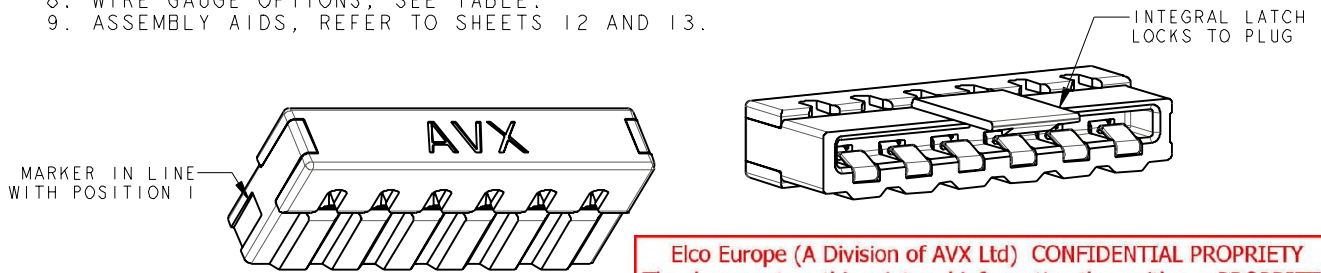

Elco Europe (A Division of AVX Ltd) CONFIDENTIAL PROPRIETY
The document on this print and information therewith are PROPRIETY
to Elco Europe (A Division of AVX Ltd) and shall not be copied
or disclosed in whole or in part without Elco Europe's written consent.

PACKING DETAILS CAP AND CONNECTOR SUPPLIED TOGETHER (TWO PARTS)

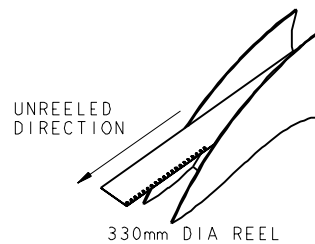
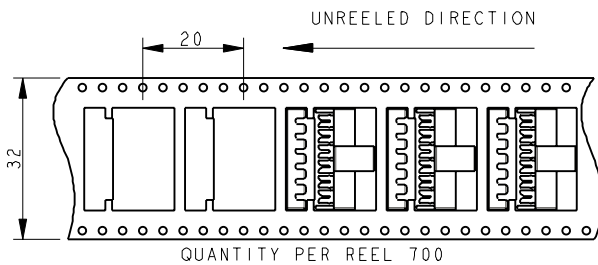

SHEET 6 OF 14

FORM-106-01-056-6 ISS 7

Release No.	102727
History	21.07.2011
	25.08.2011
	05.12.2011
	09.01.2012
	102844
	23.01.2012
	102862
	13.03.2012



ELCO
© COPYRIGHT ELCO EUROPE
NOT TO BE DISCLOSED OR COPIED
WITHOUT WRITTEN PERMISSION

Drawn	N.C.H.	Description	9159 TWO PART - ORDERING CODE
Size	CV	Part Number	24-9159-01_100S

DATE	01-July-11
Issue	3

A

B

SOCKET - WIRED - 2 WAY WIRE STOP CAP

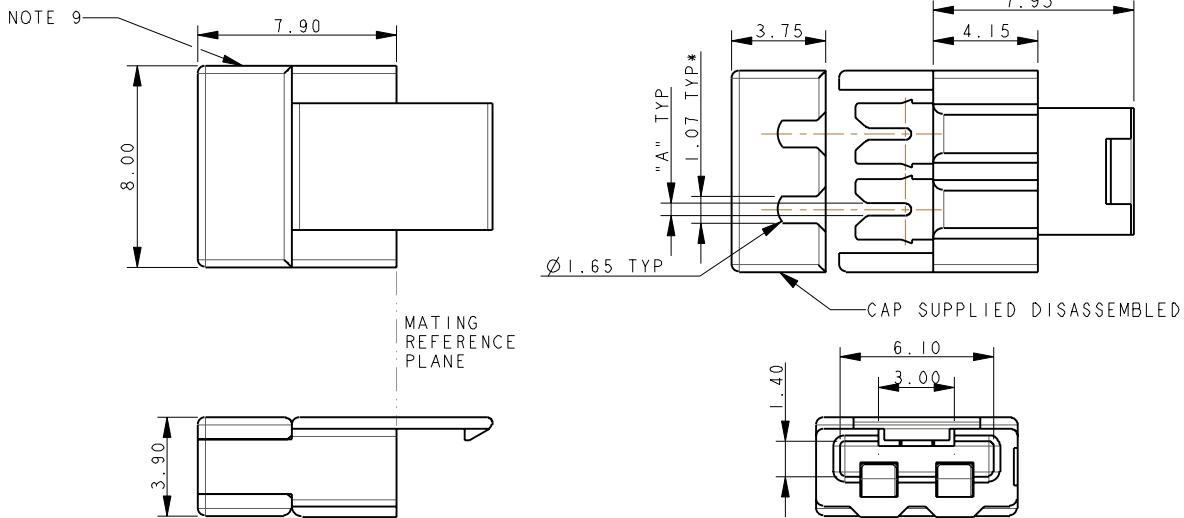

WIRE GAUGE	CODE (SHEET 1)	DIMENSION "A"	WIRE INSULATION DIAMETER
22AWG (STRANDED WIRE)	122	0.47	1.10 TO 1.60
24AWG (STRANDED WIRE)	132	0.37	1.10 TO 1.60

NOTES:

- FOR MORE INFORMATION REFER TO PRODUCT SPEC 201-01-119. FOR WIRE ASSEMBLY REFER TO APPLICATION NOTES 201-01-123.
- WIRE STOP CAP, WITH STOP FACE ON ONE SIDE TO PROTECT END OF WIRE.
- CAP ACTS AS WIRE ASSEMBLY TOOL. *WIRE PREFIT TO CAP, NARROW SLOT TO GRIP WIRE. PERMANENT ASSEMBLY.
- GENERAL TOLERANCE ± 0.20 UNLESS SPECIFIED.
- INSULATOR MATERIAL :- NYLON 46, GLASS FILLED, UL94 V-0, COLOUR REFER TO SHEET 1.
- CONTACT MATERIAL :- COPPER ALLOY, PLATING NICKEL BASE ALL OVER, GOLD ON CONTACT, TIN ON IDC.
- PACKING IN TAPE AND REEL. QTY PER REEL 700, POCKET CONTAINS 1 CONNECTOR AND 1 CAP.
- WIRE GAUGE OPTIONS, SEE TABLE.
- SHOWN WITH WIRE ENTRY FROM UNDERSIDE, CAP CAN BE ASSEMBLED FOR EITHER TOP OR UNDERSIDE WIRE ENTRY.
- ASSEMBLY AIDS, REFER TO SHEETS 12 AND 13.

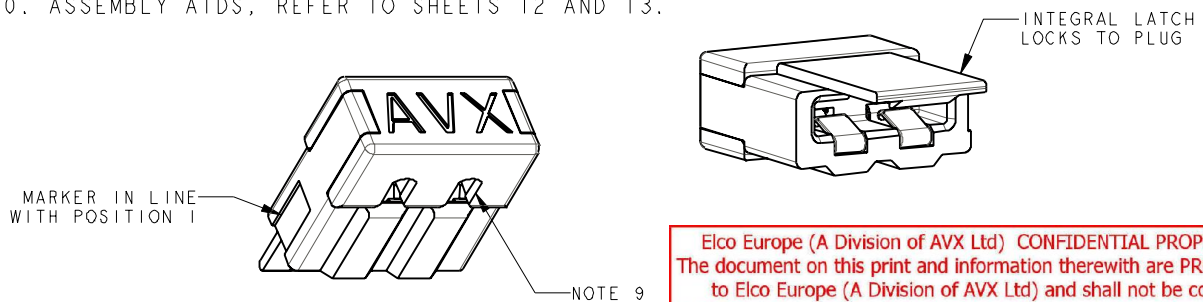

Elco Europe (A Division of AVX Ltd) CONFIDENTIAL PROPRIETY
The document on this print and information therewith are PROPRIETY to Elco Europe (A Division of AVX Ltd) and shall not be copied or disclosed in whole or in part without Elco Europe's written consent.

PACKING DETAILS CAP AND CONNECTOR SUPPLIED TOGETHER (TWO PARTS)

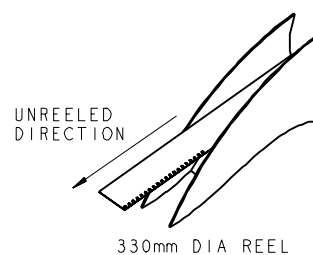
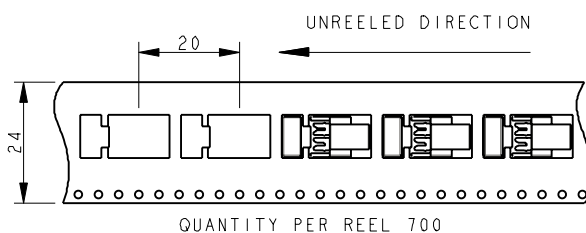

SHEET 7 OF 14

FORM-106-01-056-6 ISS 7

Release No.	102727
History	21.07.2011
	25.08.2011
	05.12.2011
	09.01.2012
	102844
	23.01.2012
	102862
	13.03.2012

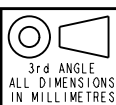

ELCO
© COPYRIGHT ELCO EUROPE
NOT TO BE DISCLOSED OR COPIED
WITHOUT WRITTEN PERMISSION

Drawn	N.C.H.
Size	CV

Description	9159 TWO PART - ORDERING CODE
Part Number	24-9159-01_100S

DATE	01-July-11
Issue	3

SOCKET - WIRED - 3 WAY WIRE STOP CAP

NOTE 9

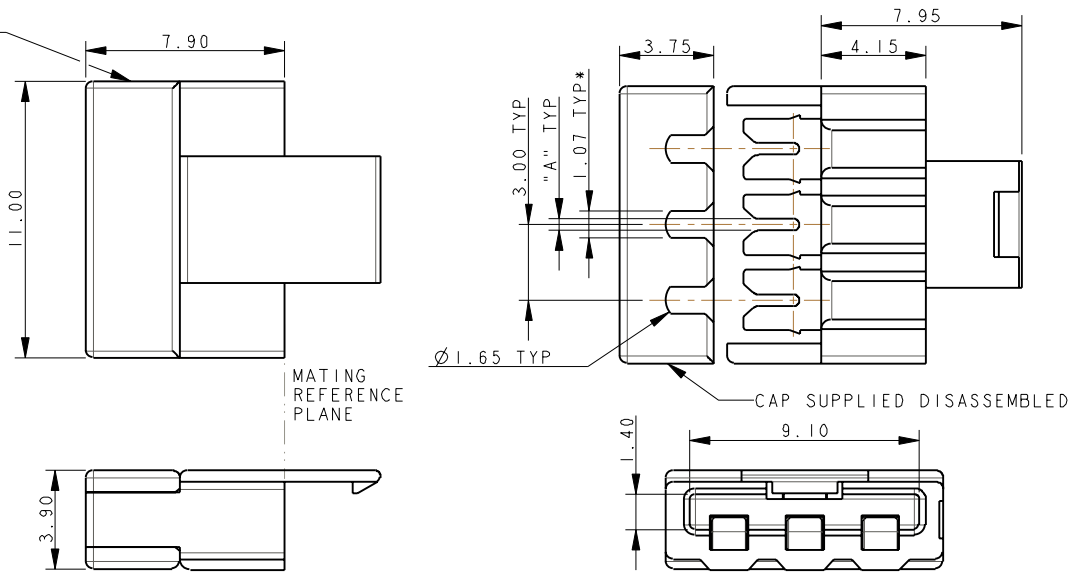

WIRE GAUGE	CODE (SHEET 1)	DIMENSION "A"	WIRE INSULATION DIAMETER
22AWG (STRANDED WIRE)	122	0.47	1.10 TO 1.60
24AWG (STRANDED WIRE)	132	0.37	1.00 TO 1.60

NOTES:

1. FOR MORE INFORMATION REFER TO PRODUCT SPEC 201-01-119. FOR WIRE ASSEMBLY REFER TO APPLICATION NOTES 201-01-123.
2. WIRE STOP CAP, WITH STOP FACE ON ONE SIDE TO PROTECT END OF WIRE.
3. CAP ACTS AS WIRE ASSEMBLY TOOL. *WIRE PREFIT TO CAP, NARROW SLOT TO GRIP WIRE. PERMANENT ASSEMBLY.
4. GENERAL TOLERANCE ± 0.20 UNLESS SPECIFIED..
5. INSULATOR MATERIAL :- NYLON 46, GLASS FILLED, UL94 V-0, COLOUR REFER TO SHEET 1.
6. CONTACT MATERIAL :- COPPER ALLOY, PLATING NICKEL BASE ALL OVER, GOLD ON CONTACT, TIN ON IDC.
7. PACKING IN TAPE AND REEL. QTY PER REEL 700, POCKET CONTAINS 1 CONNECTOR AND 1 CAP.
8. WIRE GAUGE OPTIONS, SEE TABLE.
9. SHOWN WITH WIRE ENTRY FROM UNDERSIDE, CAP CAN BE ASSEMBLED FOR EITHER TOP OR UNDERSIDE WIRE ENTRY.
10. ASSEMBLY AIDS, REFER TO SHEETS 12 AND 13.

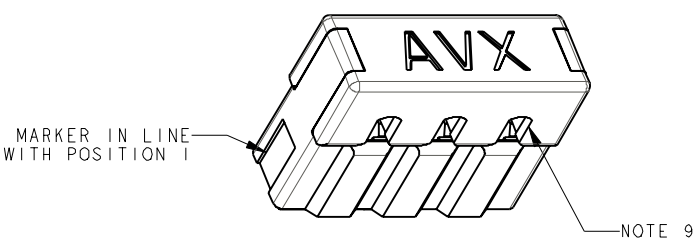
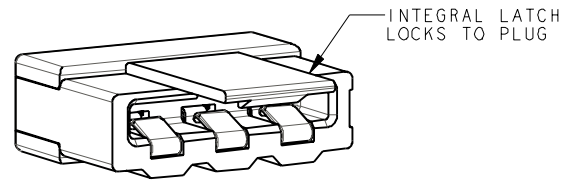

Elco Europe (A Division of AVX Ltd) CONFIDENTIAL PROPRIETY
The document on this print and information therewith are PROPRIETY to Elco Europe (A Division of AVX Ltd) and shall not be copied or disclosed in whole or in part without Elco Europe's written consent.

PACKING DETAILS CAP AND CONNECTOR SUPPLIED TOGETHER (TWO PARTS)

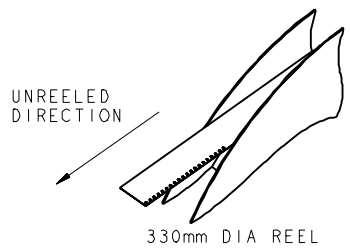
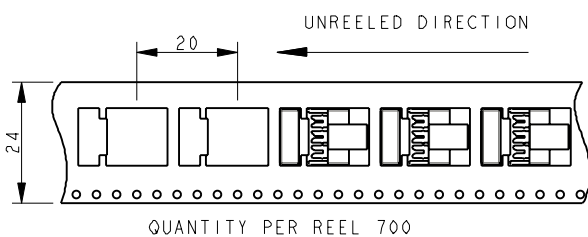

SHEET 8 OF 14

FORM-106-01-056-6 ISS 7

Release No.	102727
History	21.07.2011
	25.08.2011
	05.12.2011
	09.01.2012
	102844
	23.01.2012
	102862
	13.03.2012



ELCO
© COPYRIGHT ELCO EUROPE
NOT TO BE DISCLOSED OR COPIED
WITHOUT WRITTEN PERMISSION

Drawn
N.C.H.
Size
CV

Description	9159 TWO PART - ORDERING CODE
Part Number	24-9159-01_100S

DATE
01-July-11
Issue
3

A

B

SOCKET - WIRED - 4 WAY WIRE STOP CAP

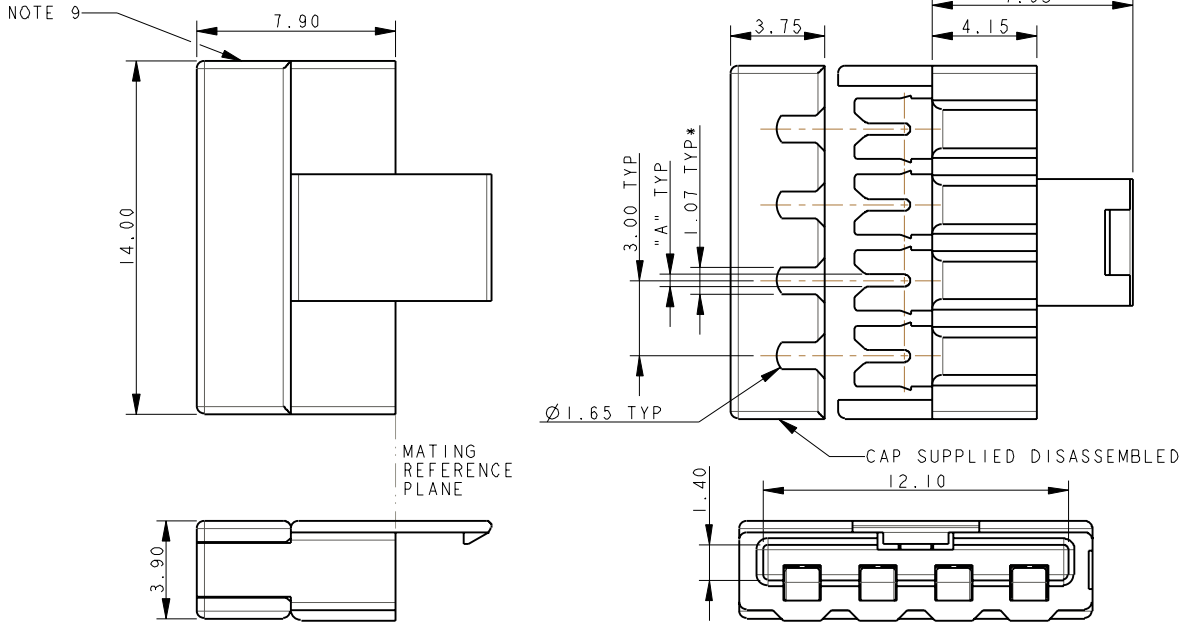

WIRE GAUGE	CODE (SHEET 1)	DIMENSION "A"	WIRE INSULATION DIAMETER
22AWG (STRANDED WIRE)	122	0.47	1.10 TO 1.60
24AWG (STRANDED WIRE)	132	0.37	1.10 TO 1.60

NOTES:

1. FOR MORE INFORMATION REFER TO PRODUCT SPEC 201-01-119. FOR WIRE ASSEMBLY REFER TO APPLICATION NOTES 201-01-123.
2. WIRE STOP CAP, WITH STOP FACE ON ONE SIDE TO PROTECT END OF WIRE.
3. CAP ACTS AS WIRE ASSEMBLY TOOL. *WIRE PREFIT TO CAP, NARROW SLOT TO GRIP WIRE. PERMANENT ASSEMBLY.
4. GENERAL TOLERANCE ± 0.20 UNLESS SPECIFIED.
5. INSULATOR MATERIAL :- NYLON 46, GLASS FILLED, UL94 V-0, COLOUR REFER TO SHEET 1.
6. CONTACT MATERIAL :- COPPER ALLOY, PLATING NICKEL BASE ALL OVER, GOLD ON CONTACT, TIN ON IDC.
7. PACKING IN TAPE AND REEL. QTY PER REEL 700, POCKET CONTAINS 1 CONNECTOR AND 1 CAP.
8. WIRE GAUGE OPTIONS, SEE TABLE.
9. SHOWN WITH WIRE ENTRY FROM UNDERSIDE, CAP CAN BE ASSEMBLED FOR EITHER TOP OR UNDERSIDE WIRE ENTRY.
10. ASSEMBLY AIDS, REFER TO SHEETS 12 AND 13.

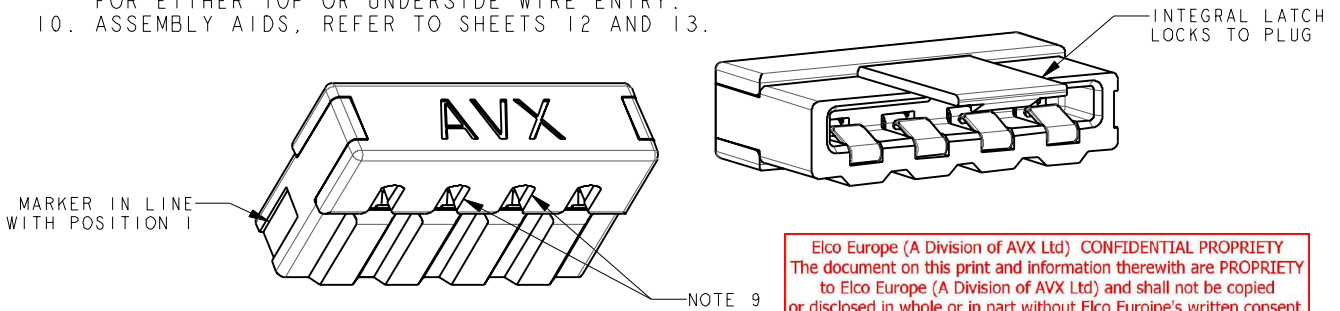

PACKING DETAILS CAP AND CONNECTOR SUPPLIED TOGETHER (TWO PARTS)

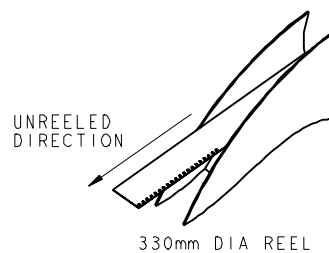
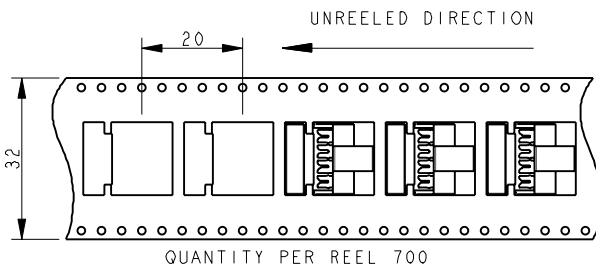

SHEET 9 OF 14

FORM-106-01-036-6 ISS 7

Release No.	102727
History	21.07.2011
	25.08.2011
	05.12.2011
	09.01.2012
	102844
	23.01.2012
	102862
	13.03.2012

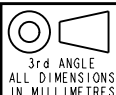

ELCO
© COPYRIGHT ELCO EUROPE
NOT TO BE DISCLOSED OR COPIED
WITHOUT WRITTEN PERMISSION

Drawn	N.C.H.
Size	CV

Description	9159 TWO PART - ORDERING CODE
Part Number	24-9159-01_100S

DATE	01-July-11
Issue	3

A

B

SOCKET - WIRED - 5 WAY WIRE STOP CAP

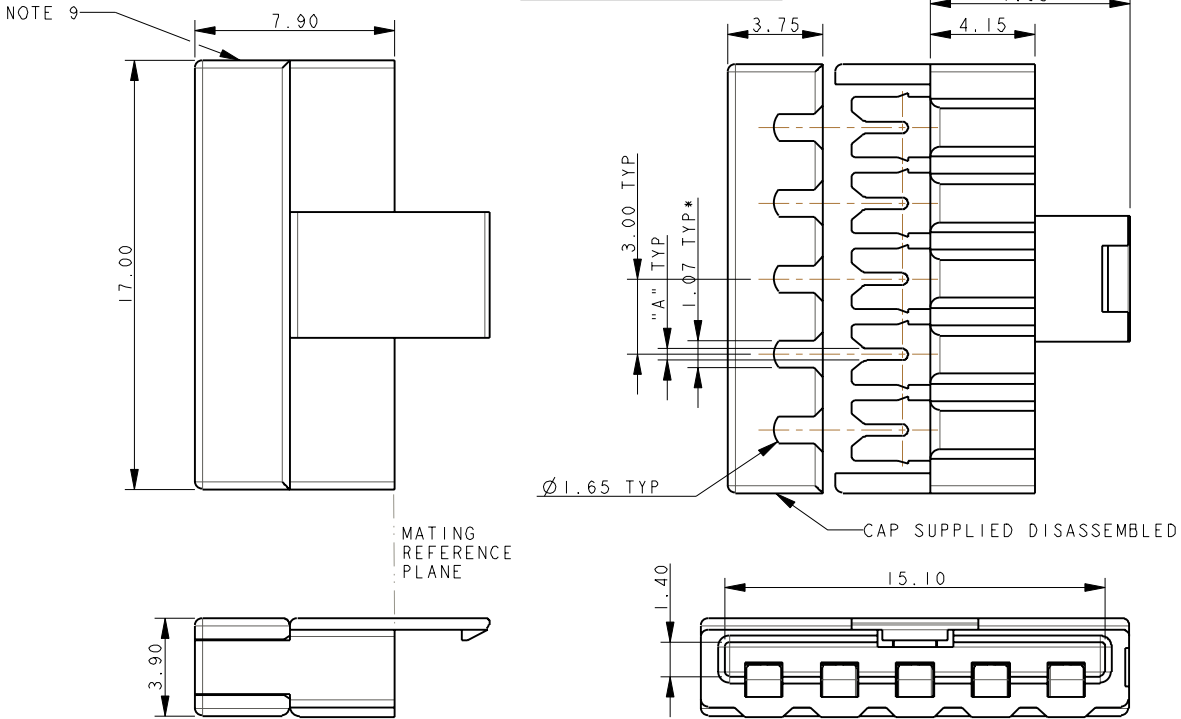

WIRE GAUGE	CODE (SHEET 1)	DIMENSION "A"	WIRE INSULATION DIAMETER
22AWG (STRANDED WIRE)	122	0.47	1.10 TO 1.60
24AWG (STRANDED WIRE)	132	0.37	1.10 TO 1.60

NOTES:

1. FOR MORE INFORMATION REFER TO PRODUCT SPEC 201-01-119. FOR WIRE ASSEMBLY REFER TO APPLICATION NOTES 201-01-123.
2. WIRE STOP CAP, WITH STOP FACE ON ONE SIDE TO PROTECT END OF WIRE.
3. CAP ACTS AS WIRE ASSEMBLY TOOL. *WIRE PREFIT TO CAP, NARROW SLOT TO GRIP WIRE. PERMANENT ASSEMBLY.
4. GENERAL TOLERANCE ± 0.20 UNLESS SPECIFIED.
5. INSULATOR MATERIAL :- NYLON 46, GLASS FILLED, UL94 V-0, COLOUR REFER TO SHEET 1.
6. CONTACT MATERIAL :- COPPER ALLOY, PLATING NICKEL BASE ALL OVER, GOLD ON CONTACT, TIN ON IDC.
7. PACKING IN TAPE AND REEL. QTY PER REEL 700, POCKET CONTAINS 1 CONNECTOR AND 1 CAP.
8. WIRE GAUGE OPTIONS, SEE TABLE.
9. SHOWN WITH WIRE ENTRY FROM UNDERSIDE, CAP CAN BE ASSEMBLED FOR EITHER TOP OR UNDERSIDE WIRE ENTRY.
10. ASSEMBLY AIDS, REFER TO SHEETS 12 AND 13.

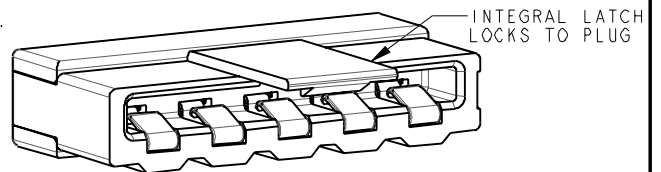
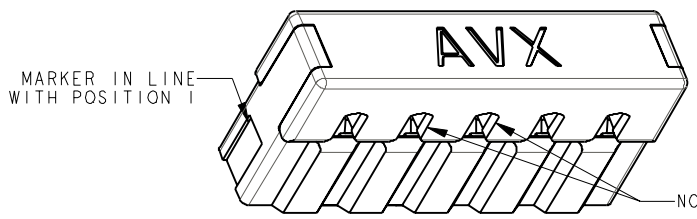

Elco Europe (A Division of AVX Ltd) CONFIDENTIAL PROPRIETY
The document on this print and information therewith are PROPRIETY
to Elco Europe (A Division of AVX Ltd) and shall not be copied
or disclosed in whole or in part without Elco Europe's written consent.

PACKING DETAILS CAP AND CONNECTOR SUPPLIED TOGETHER (TWO PARTS)

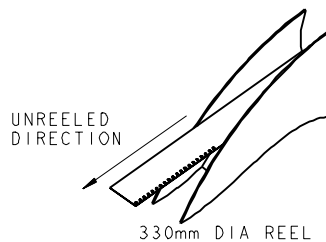
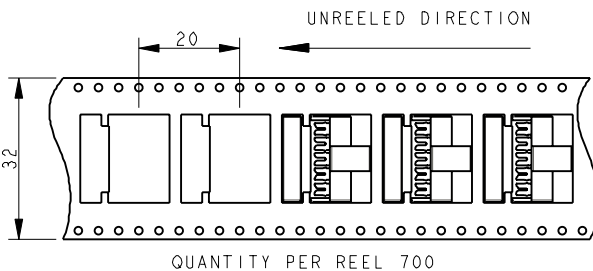

SHEET 10 OF 14

FORM-106-01-036-6 ISS 7

Release No.	102727
History	21.07.2011
	25.08.2011
	05.12.2011
	09.01.2012
	102844
	23.01.2012
	102862
	13.03.2012

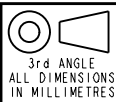

ELCO
© COPYRIGHT ELCO EUROPE
NOT TO BE DISCLOSED OR COPIED
WITHOUT WRITTEN PERMISSION

Drawn	N.C.H.
Size	CV

Description	9159 TWO PART - ORDERING CODE
Part Number	24-9159-01_100S

DATE	01-July-11
Issue	3

A

B

SOCKET - WIRED - 6 WAY WIRE STOP CAP

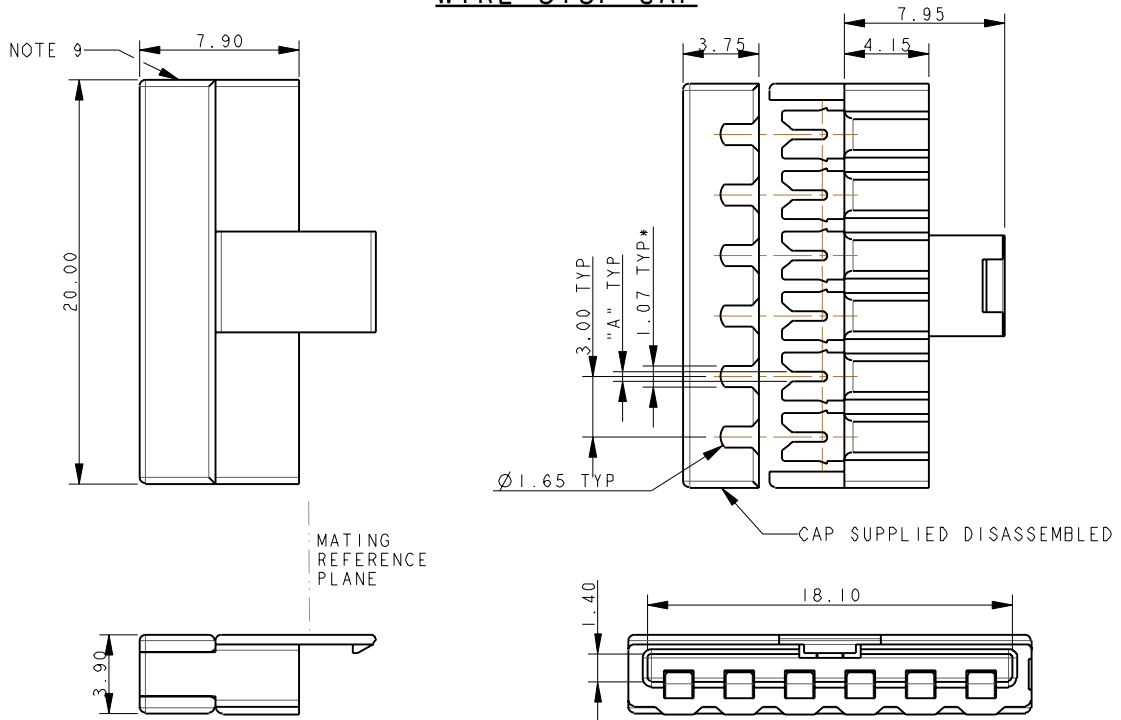

WIRE GAUGE	CODE (SHEET 1)	DIMENSION "A"	WIRE INSULATION DIAMETER
22AWG (STRANDED WIRE)	122	0.47	1.10 TO 1.60
24AWG (STRANDED WIRE)	132	0.37	1.10 TO 1.60

NOTES:

1. FOR MORE INFORMATION REFER TO PRODUCT SPEC 201-01-119. FOR WIRE ASSEMBLY REFER TO APPLICATION NOTES 201-01-123.
2. WIRE STOP CAP, WITH STOP FACE ON ONE SIDE TO PROTECT END OF WIRE.
3. CAP ACTS AS WIRE ASSEMBLY TOOL. *WIRE PREFIT TO CAP, NARROW SLOT TO GRIP WIRE. PERMANENT ASSEMBLY.
4. GENERAL TOLERANCE ± 0.20 UNLESS SPECIFIED.
5. INSULATOR MATERIAL :- NYLON 46, GLASS FILLED, UL94 V-0, COLOUR REFER TO SHEET 1.
6. CONTACT MATERIAL :- COPPER ALLOY, PLATING NICKEL BASE ALL OVER, GOLD ON CONTACT, TIN ON IDC.
7. PACKING IN TAPE AND REEL. QTY PER REEL 700, POCKET CONTAINS 1 CONNECTOR AND 1 CAP.
8. WIRE GAUGE OPTIONS, SEE TABLE.
9. SHOWN WITH WIRE ENTRY FROM UNDERSIDE, CAP CAN BE ASSEMBLED FOR EITHER TOP OR UNDERSIDE WIRE ENTRY.
10. ASSEMBLY AIDS, REFER TO SHEETS 12 AND 13.

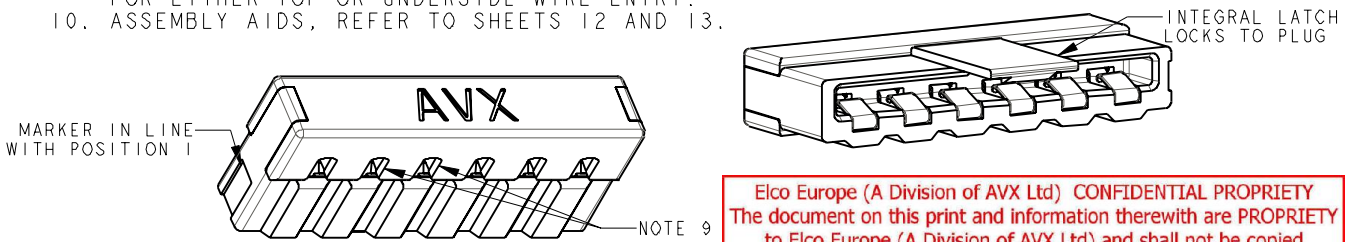

Elco Europe (A Division of AVX Ltd) CONFIDENTIAL PROPRIETY
The document on this print and information therewith are PROPRIETY
to Elco Europe (A Division of AVX Ltd) and shall not be copied
or disclosed in whole or in part without Elco Europe's written consent.

PACKING DETAILS CAP AND CONNECTOR SUPPLIED TOGETHER (TWO PARTS)

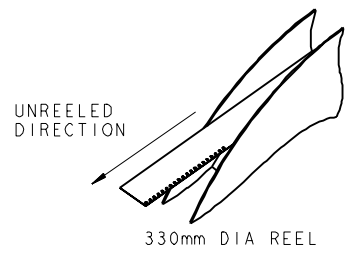
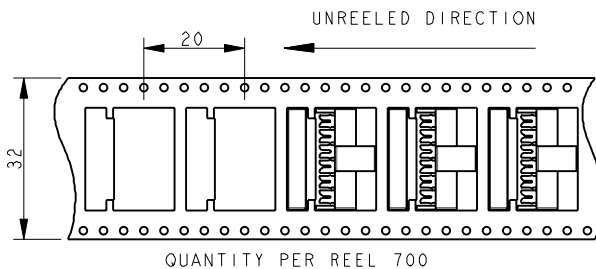

FORM-106-01-036-6 ISS 7

Release No.	102727
History	21.07.2011
	25.08.2011
	05.12.2011
	09.01.2012
	102844
	23.01.2012
	102862
	13.03.2012

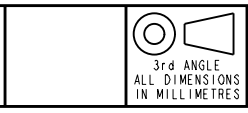

ELCO
© COPYRIGHT ELCO EUROPE
NOT TO BE DISCLOSED OR COPIED
WITHOUT WRITTEN PERMISSION

Drawn	N.C.H.	Description	9159 TWO PART - ORDERING CODE	DATE	01-July-11
Size	CV	Part Number	24-9159-01_100S	Issue	3

SHEET 11 OF 14

A | B

SOCKET - WIRED - ASSEMBLY SUPPORT BLOCK

Elco Europe (A Division of AVX Ltd) CONFIDENTIAL PROPRIETY
 The document on this print and information therewith are PROPRIETY
 to Elco Europe (A Division of AVX Ltd) and shall not be copied
 or disclosed in whole or in part without Elco Europe's written consent.

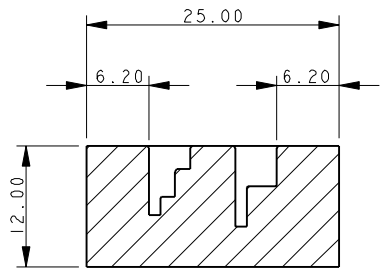
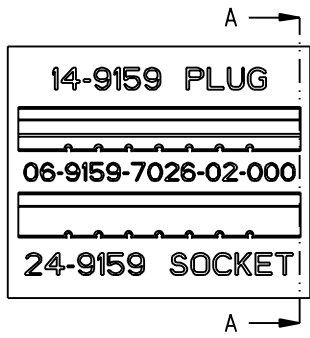

SECTION ON A-A

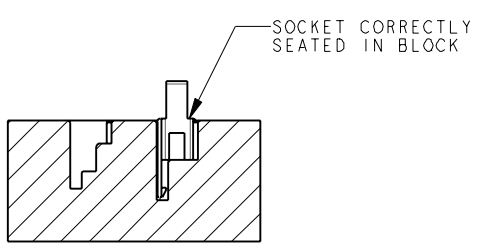

SECTION ON A-A

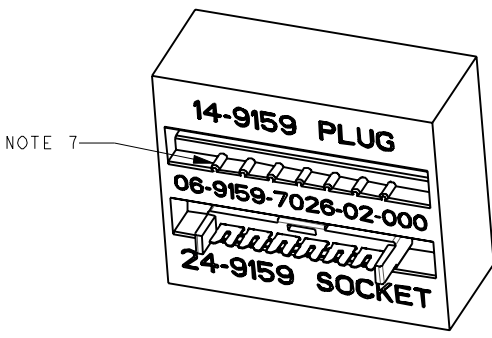

- NOTES :-
1. BLOCK TO SUPPORT 9159 IDC WIRED CONNECTORS DURING ASSEMBLY OF CAP/WIRE.
 2. PART NUMBER 06-9159-7026-01-000, MATERIAL ALUMINIUM.
PART NUMBER 06-9159-7026-02-000, MATERIAL NYLON 46.
 3. CAN BE USED WITH EITHER PLUG OR SOCKET CONNECTORS. USE THE CORRECT SLOT AS IDENTIFIED.
 4. FOR FULL WIRE ASSEMBLY DETAILS REFER TO APPLICATION NOTES 201-01-123.
 5. ONLY SIMPLE FLAT BOTTOMED TOOL REQUIRED TO PUSH CAP DOWN (NOT SUPPLIED).
 6. ALL DIMENSIONS ± 0.20 UNLESS TOLERANCED.
 7. 06-9159-7026-02-000 HAS RIBS TO HELP LOCATE CONTACT/INSULATOR SUB-ASSEMBLY.

ELCO EUROPE (A DIVISION OF AVX LTD.) CONFIDENTIAL PROPRIETY
 THE DRAWING ON THIS PRINT AND INFORMATION THEREWITH ARE
 PROPRIETARY TO ELCO EUROPE (A DIVISION OF AVX LTD.) AND
 SHALL NOT BE USED OR DISCLOSED IN WHOLE OR IN PART
 WITHOUT ELCO EUROPE'S WRITTEN CONSENT.

Release No.	
History	
102727	
21.07.2011	
25.08.2011	
05.12.2011	
09.01.2012	
102844	
23.01.2012	
102862	
13.03.2012	

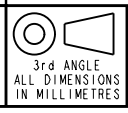

ELCO

© COPYRIGHT ELCO EUROPE
NOT TO BE DISCLOSED OR COPIED
WITHOUT WRITTEN PERMISSION

Drawn	N.C.H.	Description	9159 TWO PART - ORDERING CODE	DATE	18-Jul-11
Size	CV	Part Number	24-9159-01_100S	Issue	3

A

B



SOCKET - WIRED - WIRE INSERTION TOOL

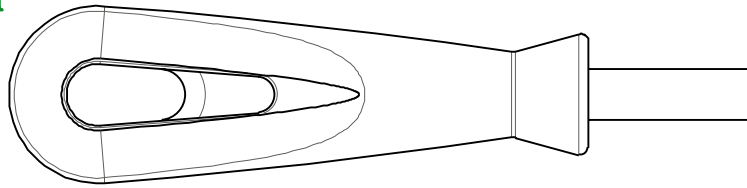

UNIVERSAL HANDLE 06-7000-7730-01-000

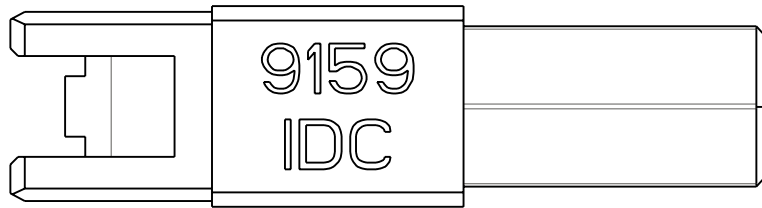
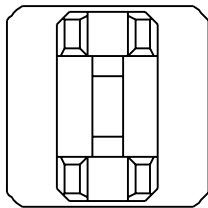

WIRE INSERTION TOOL 06-9159-7027-01-000

Elco Europe (A Division of AVX Ltd) CONFIDENTIAL PROPRIETY
The document on this print and information therewith are PROPRIETY
to Elco Europe (A Division of AVX Ltd) and shall not be copied
or disclosed in whole or in part without Elco Europe's written consent.

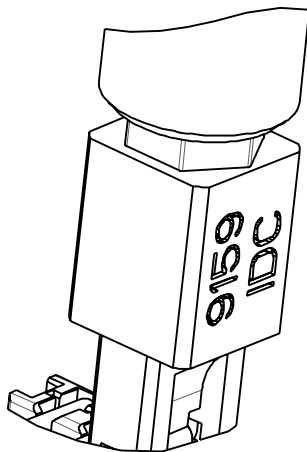

- NOTES :-
1. TOOL 06-9159-7027-01-000 TO INSERT WIRES INTO CAP.
 2. FOR USE WITH UNIVERSAL HANDLE 06-7000-7730-01-000.
 3. CAN BE USED WITH BOTH THROUGH WIRE AND WIRE STOP CAPS.
 2. REFER TO APPLICATION NOTES 201-01-123 FOR FURTHER DETAILS.

FORM-106-01-036-6 ISS 7

ELCO EUROPE (A DIVISION OF AVX LTD.) CONFIDENTIAL PROPRIETY
THE DRAWING ON THIS PRINT AND INFORMATION THEREWITH ARE
PROPRIETARY TO ELCO EUROPE (A DIVISION OF AVX LTD.) AND
SHALL NOT BE USED OR DISCLOSED IN WHOLE OR IN PART
WITHOUT ELCO EUROPE'S WRITTEN CONSENT.

Release No.	
History	
102844	23.01.2012
102862	13.03.2012

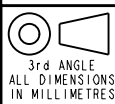

ELCO
© COPYRIGHT ELCO EUROPE
NOT TO BE DISCLOSED OR COPIED
WITHOUT WRITTEN PERMISSION

Drawn	N.C.H.
Size	CV

Description	9159 IDC CONNECTOR - WIRE INSERTION
Part Number	24-9159-01_100S

DATE	19-Jan-12
Issue	3

A

B

A

B

SOCKET - WIRED - ASSEMBLY

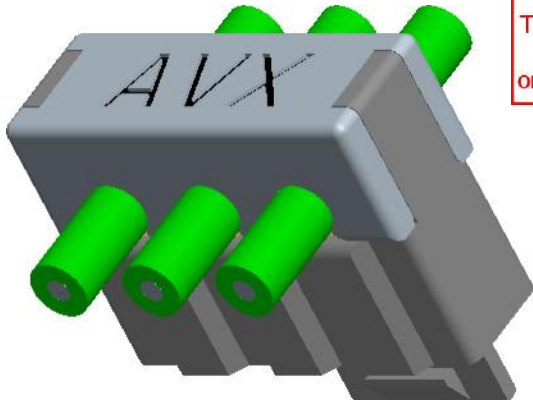

Elco Europe (A Division of AVX Ltd) CONFIDENTIAL PROPRIETY
The document on this print and information therewith are PROPRIETY
to Elco Europe (A Division of AVX Ltd) and shall not be copied
or disclosed in whole or in part without Elco Europe's written consent.

SOCKET - WIRED - ASSEMBLY
THROUGH WIRE

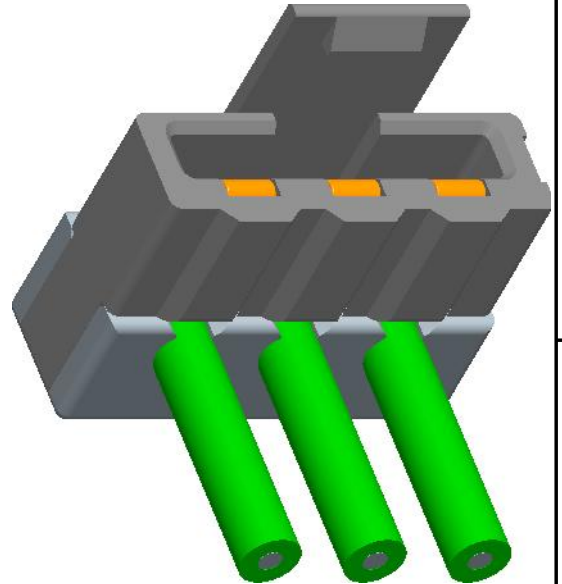

SOCKET - WIRED - ASSEMBLY
WIRE STOP - WIRE ENTRY UNDERSIDE

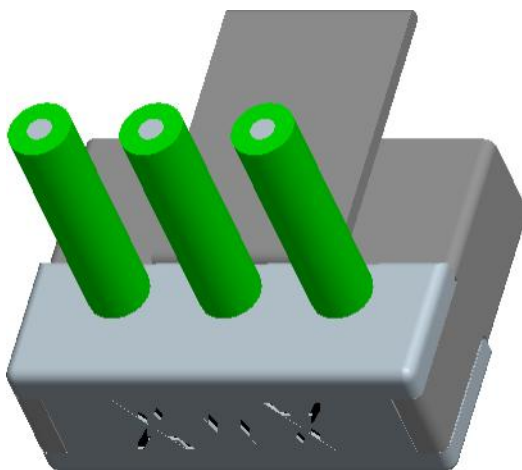

SOCKET - WIRED - ASSEMBLY
WIRE STOP - WIRE ENTRY TOP



FORM-106-01-036-6 ISS 7

ELCO EUROPE (A DIVISION OF AVX LTD.) CONFIDENTIAL PROPRIETARY
THE DRAWING ON THIS PRINT AND INFORMATION THEREWITH ARE
PROPRIETARY TO ELCO EUROPE (A DIVISION OF AVX LTD.) AND
SHALL NOT BE USED OR DISCLOSED IN WHOLE OR IN PART
WITHOUT ELCO EUROPE'S WRITTEN CONSENT.

Release No.
History
102727
21.07.2011
25.08.2011
05.12.2011
09.01.2012
102844
23.01.2012
102862
13.03.2012

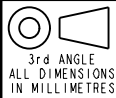

3rd ANGLE
ALL DIMENSIONS
IN MILLIMETRES

ELCO
© COPYRIGHT ELCO EUROPE
NOT TO BE DISCLOSED OR COPIED
WITHOUT WRITTEN PERMISSION

Drawn	N.C.H.
Size	CV

Description	9159 TWO PART - ORDERING CODE
Part Number	24-9159-01_100S

DATE	01-July-11
Issue	3

SHEET 14 OF 14

A

B