

MOUNTING DIMENSIONS

XXX = inches
(XXX) = millimeters

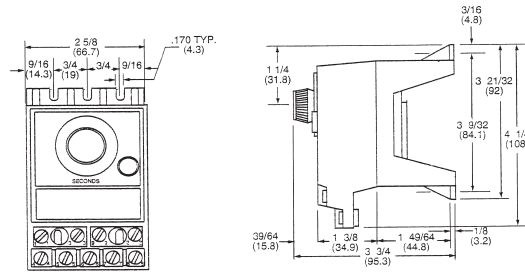

ENCLOSURES

PART NUMBER	DESCRIPTION
1701-0893	NEMA1 (General purpose)

BRE Dimensions Enclosed Construction
w/9 Position Terminal Block

ACCESSORIES

PART NUMBER	DESCRIPTION
HP50-103	120 VAC 50/60 Hz Repeat Cycle Kit
HP50-105	240 VAC 50/60 Hz Repeat Cycle Kit

ORDERING INFORMATION

SYMBOL	DESCRIPTION
E	Surface mounted with dial knob and 9 point screw type terminal block.

TIME RANGE

Sym.	Time Range	Sym.	Time Range
1	5 Sec. ***	7	5 Min.
3	15 Sec.	8	10 Min.
4	30 Sec.	9	30 Min.
5	60 Sec.	10	60 Min.
6	150 Sec.	11	5 Hr.
		12	10 Hr.

*** Not available in B6 version

VOLTAGE & FREQUENCY

SYMBOL	VOLTAGE & FREQUENCY
A6	120V 50/60 Hz
B6	240V 50/60 Hz

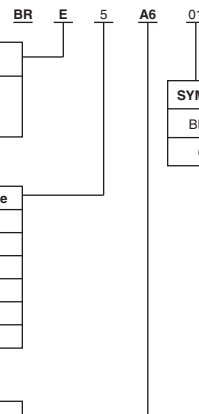

FEATURES

SYMBOL	DESCRIPTION
Blank	Standard Timer
01	Reverse Start

BRE SERIES RESET TIMER



BRE enclosed construction with front facing dial and knob.

The BRE timer has a heavy duty terminal block, with 9 screw terminals that will readily accept 16 gauge wire commonly used in industrial circuit wiring.

The case of the BR series timer is injection molded Lexan®. This material is recognized by Underwriters Laboratories for use as the sole support of current carrying components. Lexan is self-extinguishing, has a high impact strength, and high dimensional stability.

OPERATION

The NEW BRE series reset timers are micro processor driven. They provide an accurate adjustable time delay between the actuation of the control circuit and the operation of the load switches. New standard pilot light is on during timing period.

SPECIFICATIONS

Time Ranges

SYMBOL	MAXIMUM SETTING	MINIMUM SETTING	DIAL MARK DIVISIONS
1	5 sec.	.05 sec.	1/4 sec.
3	15 sec.	.15 sec.	1 sec.
4	30 sec.	.3 sec.	2 sec.
5	60 sec.	.6 sec.	2 sec.
6	150 sec.	1.5 sec.	5 sec.
7	5 min.	3 sec.	15 sec.
8	10 min.	6 sec.	30 sec.
9	30 min.	18 sec.	2 min.
10	60 min.	.6 min.	2 min.
11	5 hr.	3 min.	15 min.
12	10 hr.	6 min.	30 min.

Repeatability

Typical ± 1/4% of full scale

Reset Time

1 ms

Voltage/Frequency

120V (+10, -15%), 50/60 Hz
240V (+10, -15%), 50/60 Hz

Power Consumption

1.5 Watts

Output Rating

10 Amp - 1/4HP 120/240 VAC
1/2 Amp - 125 VDC
1/4 Amp - 240 VDC

Activation Time

150 ms

Dial Setting Accuracy

3% of Full Scale

Minimum Setting

2% of Full Scale

Operating Temperatures

-10° to 140° F (-23° to 60° C)

Laboratory Testing

U.L. Recognition E61735
F.M. Approved 21038



DAHAGER CONTROLS

2100 West Broad Street
Elizabethtown, N.C. 28337
Phone: (910) 862-2511

Printed U.S.A. 0793

BRE

BULLETIN 116E REV. 2

OPERATION

Standard Start

Instantaneous contact 8-9 and 8-3 operates directly with energization of 1 & 2, (CRI), offering different sequences of operation depending on the control circuit configuration.

Delayed contacts 6-5 close and 6-7 and 1-4 open when timer reaches a timed out condition. Contacts 6-7 and 3-4 close and 6-5 open when timer is reset.

Schematic Diagram "STANDARD START"

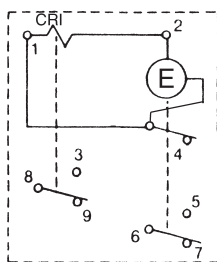

Basic Sequence of Contact Operation for BR-E "Standard Start" Timer

X – Closed Contact
O – Open Contact

	Standard Start	Reset	Timing	Timed Out
A	CRI	OFF	ON	ON
	E	OFF	ON	ON
B	8-3	O	X	X
	8-9	X	O	O
C	6-5	O	O	X
	6-7	X	X	O
	1-4	X	X	O

A. Timer Control Functions
B. Instantaneous Contacts
C. Delayed Contacts

Reverse Start

Instantaneous contact 8-9 operates directly with the energization of 1 & 2 (CRI).

Delayed contacts 6-5 close and 6-7 and 3-4 open when timer reaches a timed out position. Contacts 6-7 and 3-4 close and 6-5 open when timer is reset.

Schematic Diagram "REVERSE START"

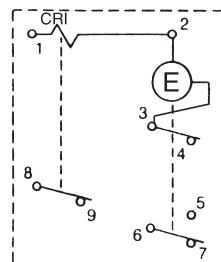

Basic Sequence of Contact Operation for BR-E "Reverse Start" Timer

X – Closed Contact
O – Open Contact

	Reverse Start	Reset	Timing	Timed Out
A	CRI	ON	OFF	OFF
	E	ON	ON	ON
B	8-9	O	X	X
	6-5	O	O	X
C	6-7	X	X	O
	3-4	X	X	O

A. Timer Control Functions
B. Instantaneous Contacts
C. Delayed Contacts

BRE WIRING DIAGRAMS
Bold Lines are Internal Wiring

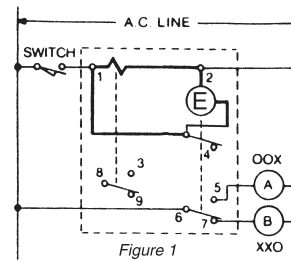

Figure 1

Standard Start Sustained Control Switch - Close to start. Open to reset. Simple delayed closing and opening of load circuits.

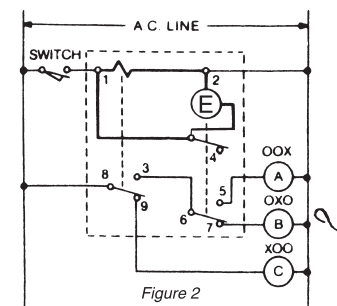

Figure 2

Standard Start - Sustained Control Switch - Close to start. Open to reset. Various control circuit operations obtained by connecting contacts in series.

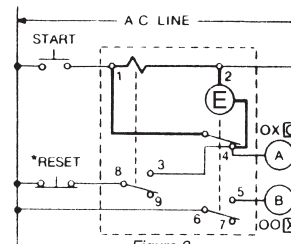

Figure 3

Momentary Start, Automatic Reset - Switch 6-5-7 transfers to timed out condition indicated by X for 3/4% of maximum dial setting.

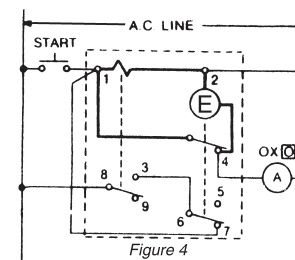

Figure 4

Momentary Start Automatic Reset - With motor shut-off protection. Use this circuit when the start switch may not always be opened before end of timing. This insures that power is removed from motor at end of timing.

* Optional RESET switch - open to reset timer during timing. If reset switch is not used, connect terminal 8 directly to line.

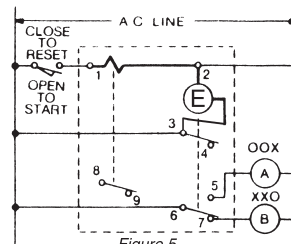

Figure 5

Reverse Start. Close switch to reset open to start timing. Timer remains in timed out condition until switch is closed to reset.

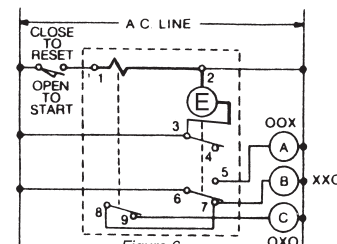

Figure 6

Reverse Start. Close switch to reset. Various control circuit operations obtained by connecting controls in series.