



# HD30 & HDP20 Series

## Contents

HD30 & HDP20 Series Overview 80

---

Dimensions 80

---

Part Numbering System 81

---

Configurations 82-83

---

Wire Insulation 83

---

Special Modifications 84-85

---

Accessories 85-87

---

Mounting 88

---

How To Instructions 89-90

---



## HD30 & HDP20 Series Overview

Designed specifically for the truck, bus, and off-highway industry, the HD30 & HDP20 Series are heavy duty, environmentally sealed, multi-pin circular connectors. Available in metal or thermoplastic housings, these connectors offer multiple pin configurations that accept contact sizes 4 through 20.

The HD30 is a metal shell while the HDP20 Series shells are thermoplastic. Both feature quick connect-disconnect bayonet coupling, single hole bulkhead mounting, silicone seals, and a rear insertion/rear removal contact system.

### HD30 Series Overview



The Deutsch HD30 Series connectors are constructed from a metal shell developed to meet the needs of the heavy duty equipment and transportation industries. The HD30 features include quick connect-disconnect bayonet coupling, single hole bulkhead mounting, silicone seals, and a rear insertion/rear removal contact system.

### HDP20 Series Overview

The HDP20 Series is a heavy duty rated, environmentally sealed, composite shell, multi-pin connector. The composite thermoplastic shell is ideal in applications where chemicals can damage a connector housing. HDP20 features quick connect-disconnect bayonet coupling, single hole bulkhead mounting, silicone seals, and a rear insertion/rear removal contact system.



### HD30 & HDP20 Series Dimensions

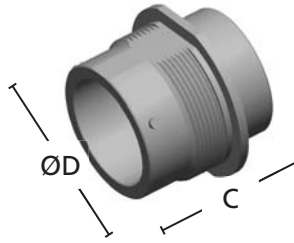
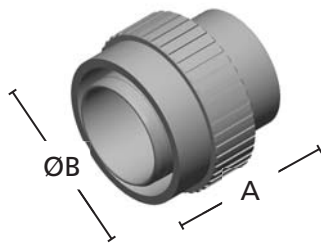

Shell Size	HD/HDP Plug		HD/HDP Receptacle	
	Overall Length A	Overall Height ØB	Overall Length C	Overall Height ØD
18	1.521 (38.63)	1.700 (43.17)	1.648 (41.86)	1.750 (44.45)
24	1.521 (38.63)	1.950 (49.53)	1.648 (41.86)	2.000 (50.80)

Dimensions are for reference only.

■ HD30 Series Part Numbering System

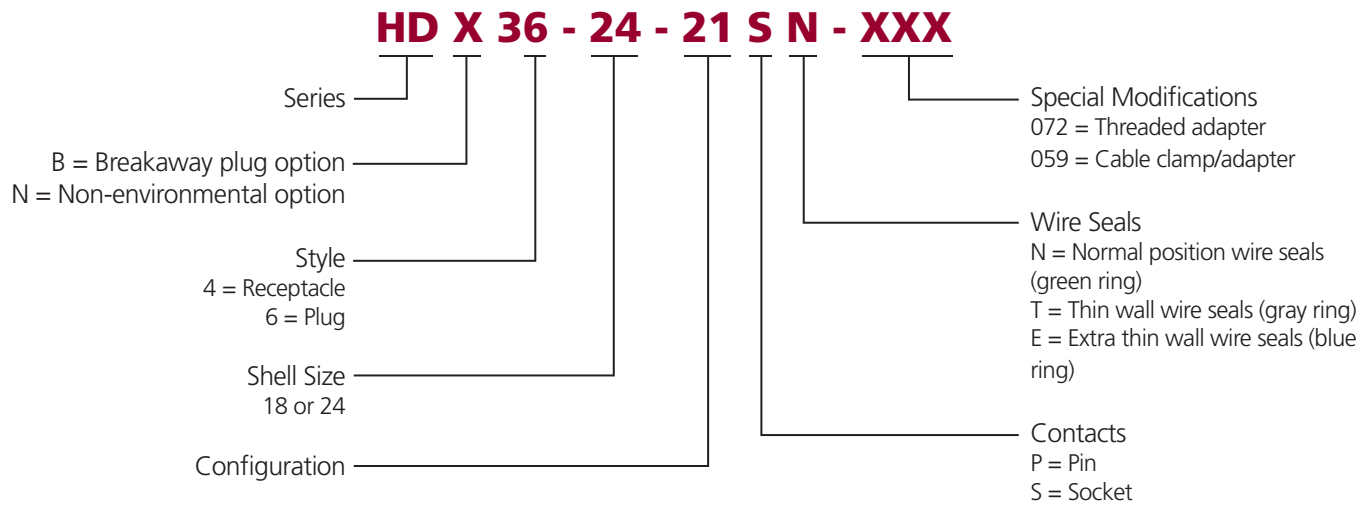

**Notice**  
Reverse arrangements are available as a keying option for the HD30 & HDP20 Series.

■ HDP20 Series Part Numbering System

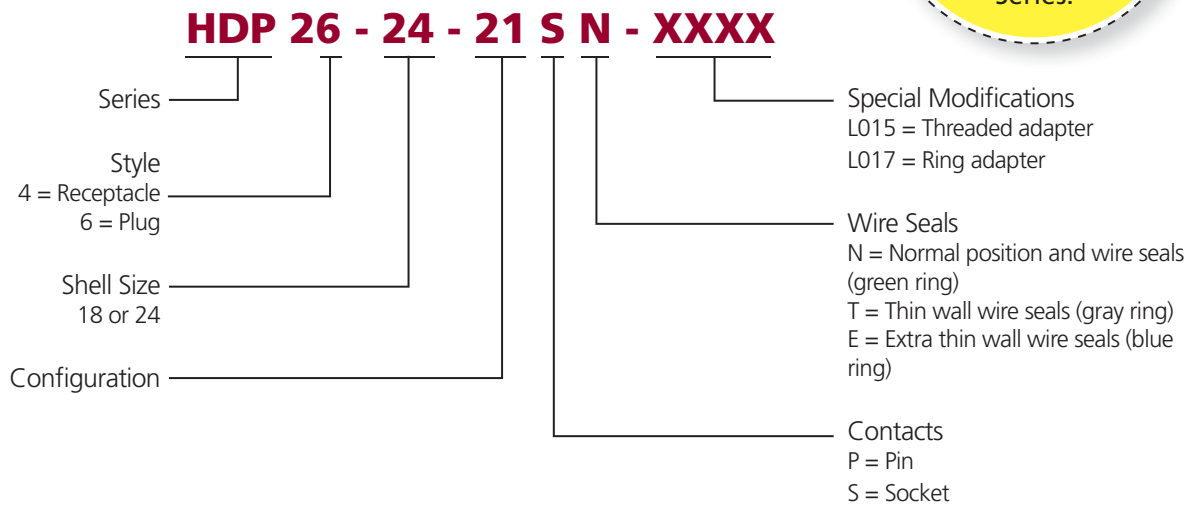

*helpful hint*

Making the socket contact side the "hot side" can reduce the danger of electric shock.

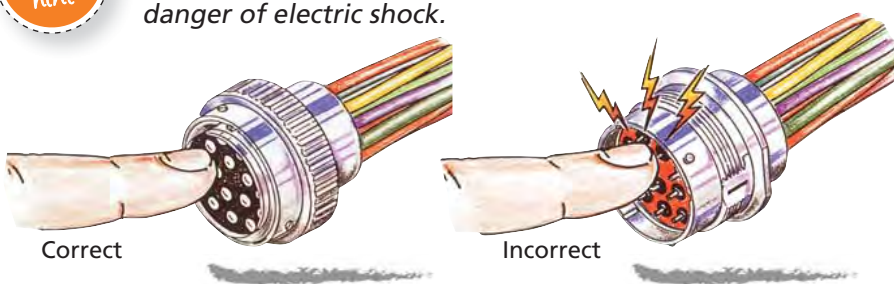



## HD30 & HDP20 Series Configurations

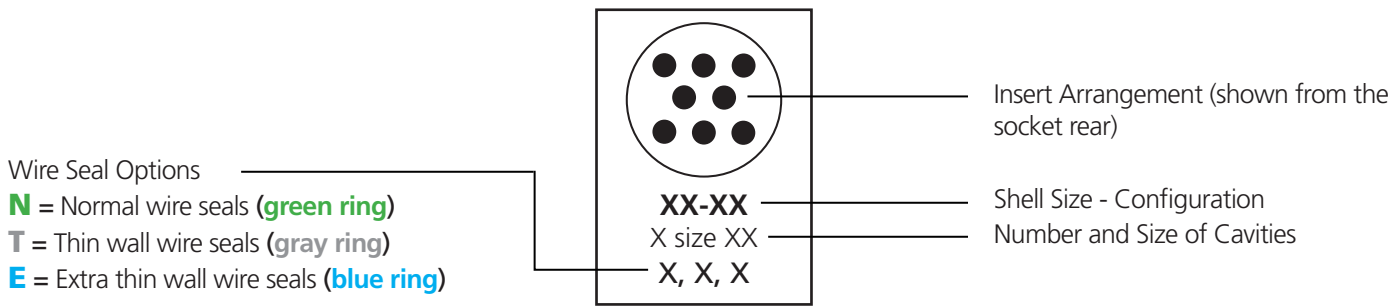

### 18 Shell Size Configurations

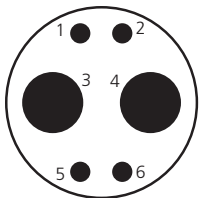

**18-6**  
2 size 4 & 4 size 16  
**N, E**

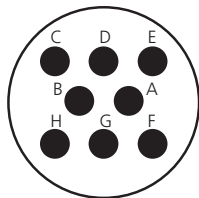

**18-8**  
8 size 12  
**N, E**

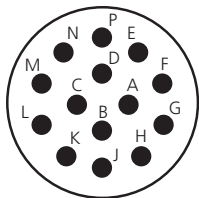

**18-14**  
14 size 16  
**N, T, E**

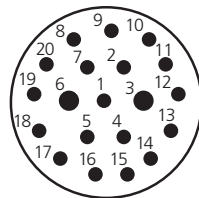

**18-20**  
2 size 16 & 18 size 20  
**N, E**

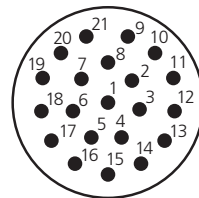

**18-21**  
21 size 20  
**N**

### 24 Shell Size Configurations

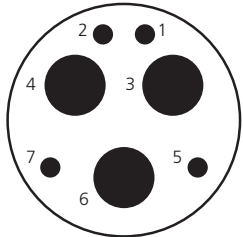

**24-7(-C038 only)**  
3 size 4† & 4 size 16  
**N**

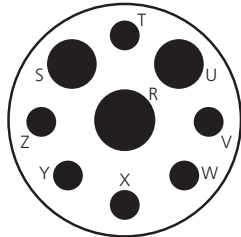

**24-9**  
1 size 4, 2 size 8  
& 6 size 12  
**N, E**

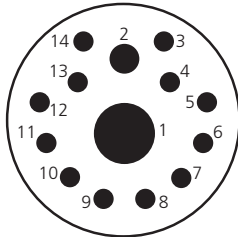

**24-14**  
1 size 4, 1 size 12  
& 12 size 16  
**N, E**

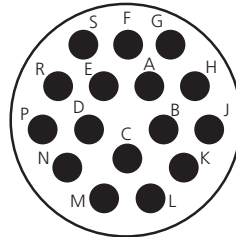

**24-16**  
16 size 12  
**N, E**

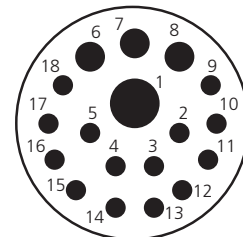

**24-18**  
1 size 8, 3 size 12  
& 14 size 16  
**N, E**

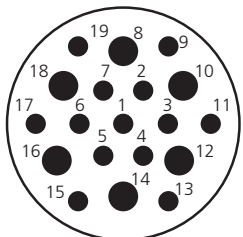

**24-19**  
6 size 12  
& 13 size 16  
**N, E**

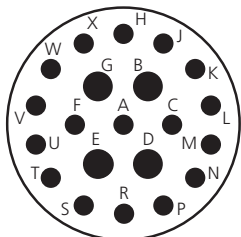

**24-21**  
4 size 12  
& 17 size 16  
**N, E**

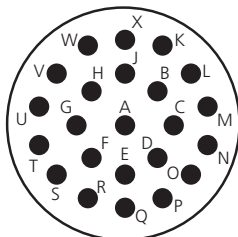

**24-23**  
23 size 16  
**N, T, E**

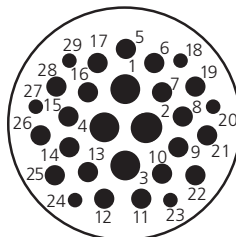

**24-29**  
4 size 12, 19 size 16  
& 6 size 20  
**E\***

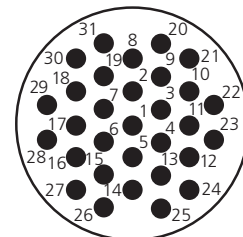

**24-31**  
31 size 16  
**T\*, E\***

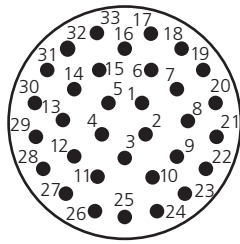

**24-33**  
33 size 20  
**N**

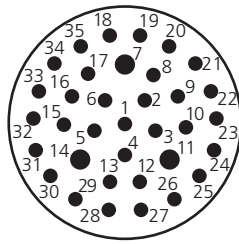

**24-35**  
3 size 16 & 32 size 20  
**N, E**

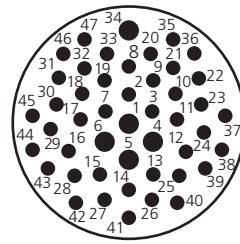

**24-47**  
5 size 16 & 42 size 20  
**E\***

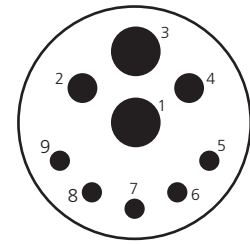

**24-91-P064‡**  
2 size 8, 2 size 12 &  
5 size 16  
**N, E**

\*Modified seal, see drawing

‡Without P064 modification, plug cavities 4 and 5 are internally connected

**Wire Insulation**

Contact Size	Recommended Wire Insulation O.D.		
	N Seal Green Ring	T Seal Gray Ring	E Seal Blue Ring
20	.040-.095 (1.02-2.41)	.040-.095 (1.02-2.41)	.040-.095 (1.02-2.41)
16	.100-.134 (2.54-3.40)	.088-.134 (2.23-3.40)	.053-.120 (1.35-3.05)
12	.134-.170 (3.40-4.32)	.113-.170 (2.87-4.32)	.097-.158 (2.46-4.01)
8	.190-.240 (4.83-6.10)	.170-.240 (4.32-6.10)	.135-.220 (3.43-5.59)
4	.280-.292 (7.11-7.42)	.261-.292 (6.63-7.42)	.261-.292 (6.63-7.42)

**Connector Identification**



Mating Slot Positions



Color Coded Ring

**Notice**  
Undersized wire insulation is a major cause for leakage.

Color code is visible from the rear of the receptacle or plug.

- Green:** Normal Seal
- Gray:** Thin Wall Seal
- Blue:** Extra Thin Seal



## Special Modifications

The HD30 & HDP20 Series connectors offer several modifications to enhance design flexibility and meet application specific needs. Options include breakaway plugs, adapters, and high amperage options just to mention a few. By combining the HD30 & HDP20 Series connectors with the available modifications and accessories, the design possibilities are greatly expanded.

### ■ HDB - Breakaway Plug (HD30 Series Only)



The HDB is designed to provide an emergency disconnect between farm tractors and implements that require power connections. The HDB breakaway plug is designed to break the connection before damaging the wiring system. These plugs can be specified with pin or socket contacts and connect only with the HD30 Series receptacles. As an added design convenience, the HDB is also available with an optional cable clamp (059 mod). Breakaway function occurs at an axial load of 50-100 lbs.

### ■ L015/L017 Modifications

The L015 threaded adapter and L017 ring adapter modifications are available for the Deutsch HDP20 Series. These adapter modifications provide simple, low cost assembly solutions for applications that require a backshell or conduit. The L015/L017 modifications must be ordered with the initial connector, as it is factory assembled. The adapters are designed to be used with the backshell of your choice.

- The L015 threaded adapter is available on size 24 shells in the HDP20 Series.
- The L017 ring adapter is available on size 24 or size 18 shells in the HDP20 Series.



L015  
Threaded Adapter



L017  
Ring Adapter

### ■ C030 Modification



Originally designed for multiplexing and battery cable applications, Deutsch's C030 modification is an environmentally sealed, heavy duty two cavity connector that accepts size 4 solid contacts rated up to 100 amps for each cavity.

The C030 modification is available in size 18 shell in both metal (HD30 Series) and thermoplastic (HDP20 Series) to provide the perfect solution to all of your heavy wire gauge applications.



**■ Cable Clamp/Backshell Modifications**

Deutsch cable clamps provide positive support to the wire bundle while reducing strain on the connector. The backshell is available with or without drain holes.



Part Number Suffix	Description
-072	Adapter only
-059	Adapter and cable clamp assembly with drain holes
-L006	Adapter and cable clamp assembly without drain holes

**Accessories**

Deutsch Industrial offers several accessory items that are used to complement the connectors. The HD30 & HDP20 family accessories include items such as boots, backshells, gaskets, and protective caps. Accessories are designed to complete the application and meet a wide array of design requirements such as solutions for mounting, providing additional protection, and offering increased aesthetics.

**■ Protective Dust Caps**

Protective caps are available for both plug and receptacle halves of the connectors. The metal caps, for use with the HD30 Series, come with a mounting chain and are used to protect the connector while not mated. The thermoplastic caps, for use with the HDP20 Series, are available with or without a lanyard.



Shell Size	Part Number*	Connector
18	HDC26-18	Plug cap for receptacle protection
24	HDC26-24	Plug cap for receptacle protection
18	HDC36-18	Plug cap for receptacle protection
24	HDC36-24	Plug cap for receptacle protection
18	HDC34-18	Receptacle cap for plug protection
24	HDC34-24	Receptacle cap for plug protection

\*To order HD30(HD3\*-\*\*) protective caps without the mounting chain, add -1E to the end of the part number

**■ Boots**



Boots provide a professional looking finishing touch for the Deutsch HD30 & HDP20 family of connectors. Made of durable plastisol, these slip-on boots are not only aesthetically appealing, but also provide increased protection from dirt, paint overspray, and pressure washing. The plastisol boots are rated from -20° F to +212° F and offer a slip-on design making installation quick and easy.



**Boot**

Part Number	Description
HD30-18BT	18 shell size boot, gray
LC-90BT-HT	18 shell size boot, 90° bend, high temperature material, yellow
HD30-18BT-90-BK	18 shell size boot, 90° bend, black
HD30-24BT	24 shell size boot, gray
HD30-24BT-BK	24 shell size boot, black
MT-90BT-HT-24	24 shell size boot, 90° bend, high temperature material, yellow
HD30-24BT-90-BK	24 shell size boot, 90° bend, black



## Strain Relief

The Deutsch HD30 & HDP20 Series offer several backshell options to meet your design needs. Backshell options include straight or 90° and plastic or metal. The metal backshells work best with the HD30 Series. It is attached to the rear of the connector using an adjustable screw and is secured to the wire bundle with the use of a tie wrap. The plastic backshells work best with the HDP20 Series and attach to the rear of the connector with either a clamshell snap closure or by screwing them on to a threaded adapter. The rigid, durable backshells offer a high level of protection, provide strain relief, and improve aesthetics.



### HD30 Series Backshell

Shell Size	Orientation	Part Number
18	Straight	WHDS-18-1
24		WHDS-24-1
18	90°	WHDS-18-2
24		WHDS-24-2



### HDP20 Series L017 Backshell

Shell Size	Orientation	Part Number	Conduit Size
18	Straight	2428-016-1805	13, 17, 19 (mm) NW
	90°	2428-015-1805	13, 17, 19 (mm) NW
24	Straight	2428-008-2405	1"
	90°	2428-004-2405	1"
24	Straight	2428-010-2405	17, 19, 23, 26 (mm) NW
	90°	2428-011-2405	17, 19, 23, 26 (mm) NW

NW = Nominal Width of the conduit's inside diameter. See drawings for full specifications.



Seal Ring

Cap Nut

### HDP20 Series L015 Conduit Adapter

Shell Size	L015 Conduit Adapter Part Numbers		Conduit Size
24	Seal Ring: SRN21	Cap Nut: CN21	22 (mm) NW

## Backshells for L015 Modification



The Deutsch HDP20 Series backshells are designed to screw onto connectors with the L015 modification, which adds a threaded adapter. Rated for temperatures from -40°C to +134°C, the rigid, durable backshells offer a high level of protection, provide strain relief, and improve aesthetics.



Backshell

Compression Nut

### HDP20 Series L015 Backshell

Shell Size	Cable Diameter	Backshell	Compression Nut
24	.430-.570	M902-2243	M902-2053
	.570-.710	M902-2244	M902-2054

#### Backshell Technical Specifications:

Material - PC/PET Polyester Blend, UV-Stabilized, Flame Retardant, Black  
Flammability - UL94-VO, Weatherability - UL746C



**Mounting Hardware**

Deutsch offers lockwashers and panel nuts to aid in mounting the HD30 and HDP20 Series connectors. The lockwashers are used to add tension between the threads and the nut to provide a secure mount. The lockwasher and the panel nut should be used together.

**Panel Lockwasher**

Shell Size	Part Number	ØA	B
18	114021*	1.886	.062 (1.57)
	2414-002-1886**	(47.90)	.020 (0.51)
24	112264*	2.074	.062 (1.57)
	2414-001-2486**	(52.68)	.020 (0.51)

Dimensions are for reference only.  
 \*For use on HD30 Series only.  
 \*\*For use on HDP20 Series only.

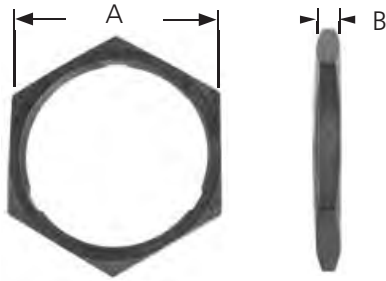
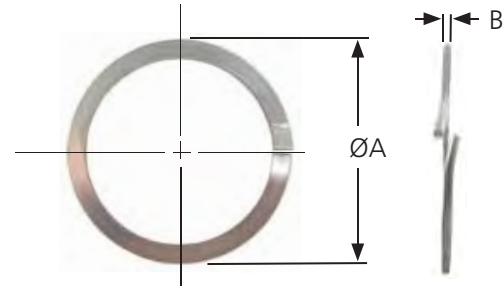

**Panel Nut**

Shell Size	Part Number	Material	A	B
18	114020-90*	Metal	1.685	.178 (4.52)
	2411-002-1805	Plastic	(42.80)	.250 (6.35)
24	112263-90*	Metal	1.875	.178 (4.52)
	2411-001-2405	Plastic	(47.63)	.250 (6.35)

Dimensions are for reference only.  
 \*For use on HD30 Series only.

**Panel Nut Mounting Torque**



HD30 18 Shell Size	260-280 IN. LB. (29.4-31.6 N.M.)
HDP20 18 Shell Size	45-55 IN. LB. (5.1-6.1 N.M.)
HD30 24 Shell Size	350-375 IN. LB. (39.5-42.6 N.M.)
HDP20 24 Shell Size	65-75 IN. LB. (7.4-8.4 N.M.)

**Gaskets**



Moisture, dirt, salt, sand, and road debris can all work their way into electrical panels through unsealed mounting flanges. Rated to operate in environments from -70°F to +225°F, these rugged high quality neoprene gaskets form a tight seal between the panel face and connector flange to help keep out destructive elements. The gaskets have a thickness of .125" and meet the UL-94-HBF, Mil-R-6130C, and FMVSS-302 flammability specifications.



	
16-04978 (18 Shell Size Receptacle)	16-04477 (24 Shell Size Receptacle)



## Mounting

### Receptacle Mounting

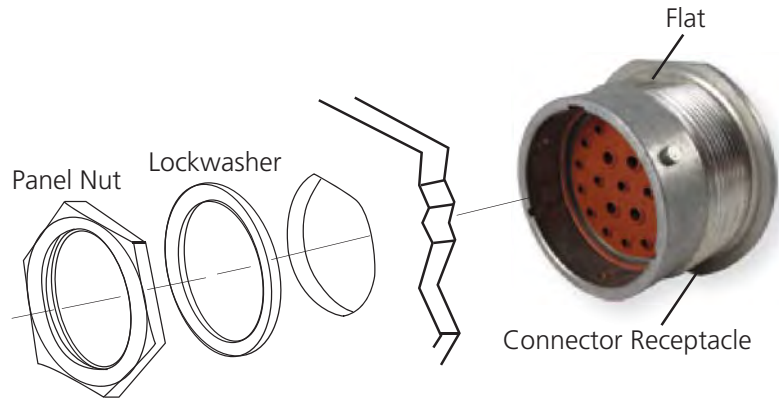
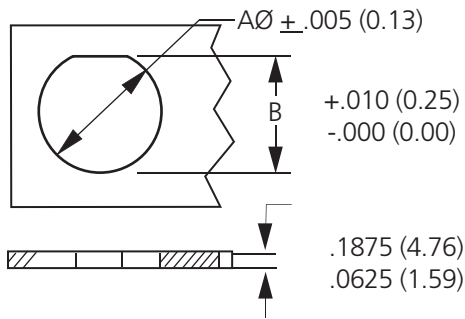

### Recommended Size of Mounting Hole

Shell Size	A $\varnothing$	B
18	1.507 (38.28)	1.442 (36.63)
24	1.696 (43.08)	1.632 (41.45)

### D Hole Punch



The D hole punch is a hand tool used to cut a D shaped hole. The D shaped hole allows the connector to be securely mounted and prevents the connector from spinning.



#### Punchable Material:

Up to .078" mild steel or aluminum. Up to .1875" plastic, wood, paneling, or other soft material.

#### Tool Material:

A2 material heat treated to a Rockwell hardness of 60 to 62.

#### Tool Size: (rough dimensions)

5.5" L x 2" H x 2" D

#### Sharpening:

The tool can be sharpened as needed.

#### Usability:

A .625" minimum pilot hole is required to accommodate the draw stud. Air tools can be used.

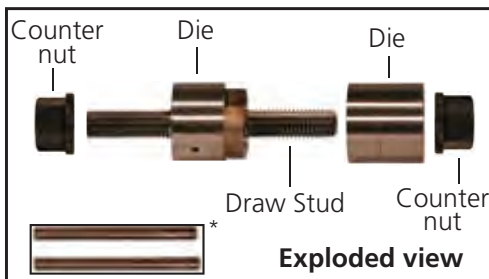

\*The rods included with the "D" hole punch are used to remove the cutout and are not used in the cutting process.

Shell Size	Part Number
18	18-D-PUNCH
24	24-D-PUNCH

## How To Instructions

### ■ Contact Insertion



**Step 1:**  
Grasp contact approximately one inch behind the contact crimp barrel.



**Step 2:**  
Hold connector with rear grommet facing you.



**Step 3:**  
Push contact straight into connector grommet until a positive stop is felt. A slight tug will confirm that it is properly locked in place.

### ■ Contact Removal

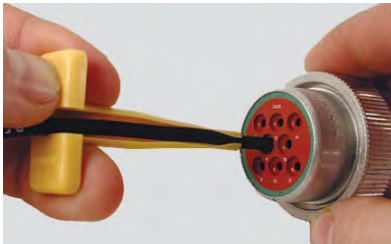

**Step 1:**  
With rear insert toward you, snap appropriate size removal tool over the wire of contact to be removed.



**Step 2:**  
Slide tool along the wire until it engages contact and resistance is felt.



**Step 3:**  
Pull contact wire assembly out of connector.

*Notice*  
Do not twist or insert tool at an angle.



*Mounting connectors horizontally allows proper water drainage.*

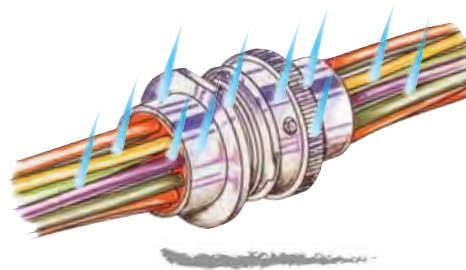



## ■ Mating Instructions

To mate the plug and the receptacle, line up the index groove on the plug with the flat surface on the receptacle, turn 1/4 turn clockwise. You will feel and hear the pieces snap into the locked position. To unmate the plug and receptacle, release the coupling ring by turning it counter-clockwise.

### *Notice*

When mating or unmating connectors, disassemble by hand. Do not use pliers or any other tool.

