

LEB Connector

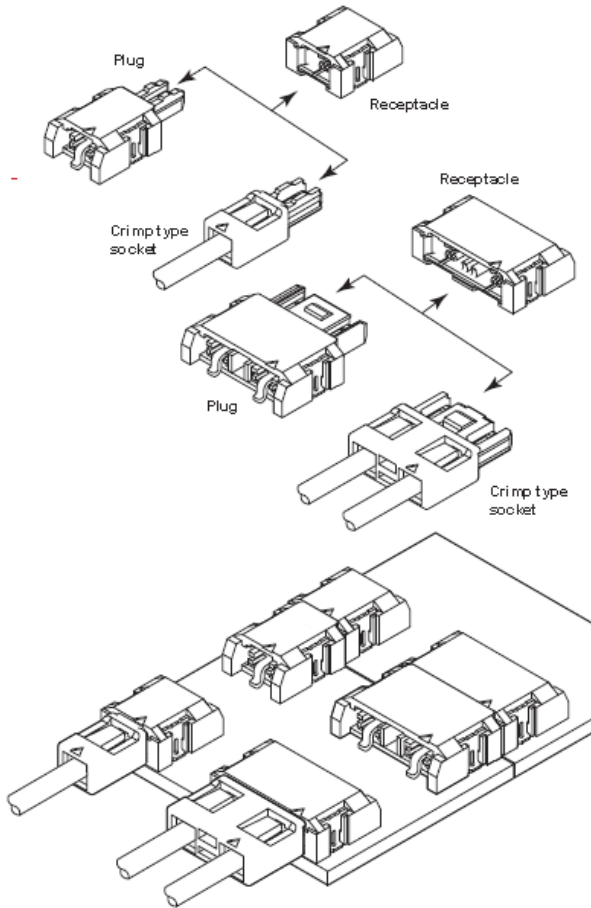

1.8mm pitch / Board-Board and Wire-Board Crimp Disconnectable



Designed for LED light bar applications, the low profile of the connector does not interfere with the *luminescence angle of LED dies*. The LEB Series provides both board-to-board and wire-to-board capabilities. The board-to-board plug and receptacle connectors allows continuous connection of LED light bars

Features

- Absorption misalignment mechanism
- Prevention of mismatching.
- Common PCB layout for both plug and receptacle connectors.
- Both board-to board and wire-to-board interconnection capability.
- Meets the requirement of JIS C 8121-2-2-2009 and IEC 60838-2-2-2006 for Miscellaneous lamp holders -Part 2-2: Particular requirements- Connectors for printed circuit board based LED-modules.

Specifications

- Current rating: 3A AC, DC (AWG#22)
- Voltage rating: 300V AC,DC
- Temperature range: -55°C to $+105^{\circ}\text{C}$
(including temperature range rise in applying electrical current)
- Contact resistance: Initial value/10m Ω max.
After environmental testing/20m Ω max.
- Insulation resistance: 1,000M Ω min.
- withstanding voltage: AC 1,700V / 1minute
- Applicable wire: Conductor size/AWG#30 to AWG#22
Insulation O.D./0.7 to 1.3mm dia.
- Refer to "General Instruction and Notice when using Terminals and Connectors at the end of the catalog.
- Contact JST for details.

Standards



Recognized E60389

LEB connector

Socket Housing

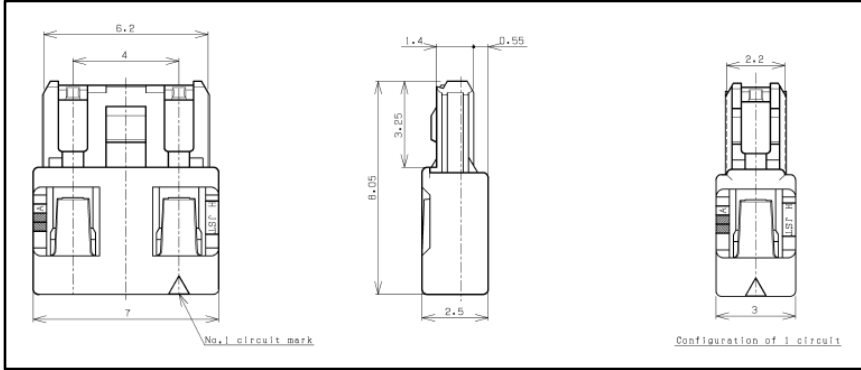

Circuits	Model No.
1	LEBRP-01V-S
2	LEBRP-02V-S

Material	
PBT, UL 94V-0	

Contact

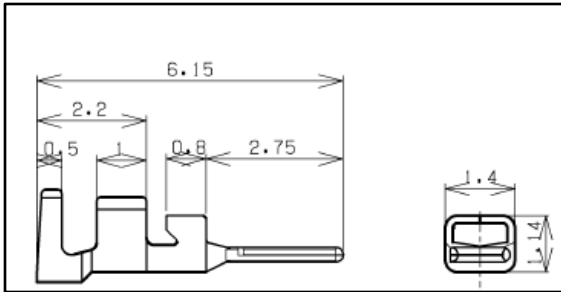

Model No.	Applicable wire			Qty/reel
	mm ²	AWG #	Insulation O.D. (mm)	
SLEB-001T-P0.2	0.13~0.33	26~22	0.95~1.3	15,000

Material and Finish	
Copper alloy, tin-plated (reflow treated)	

PC Board Layouts

Receptacle Headers

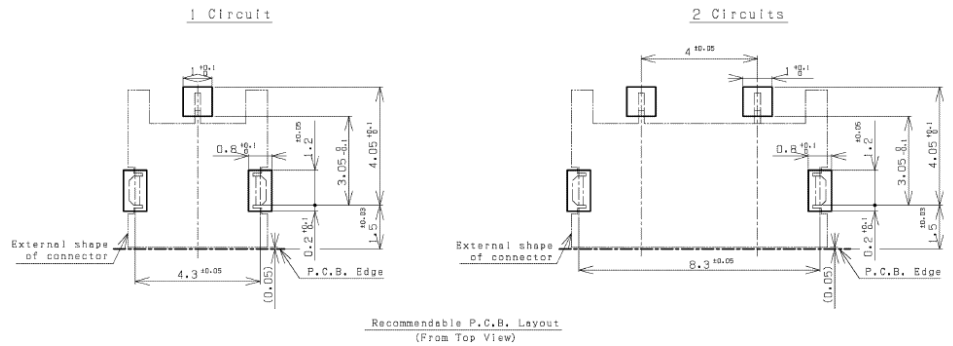

Plug Headers

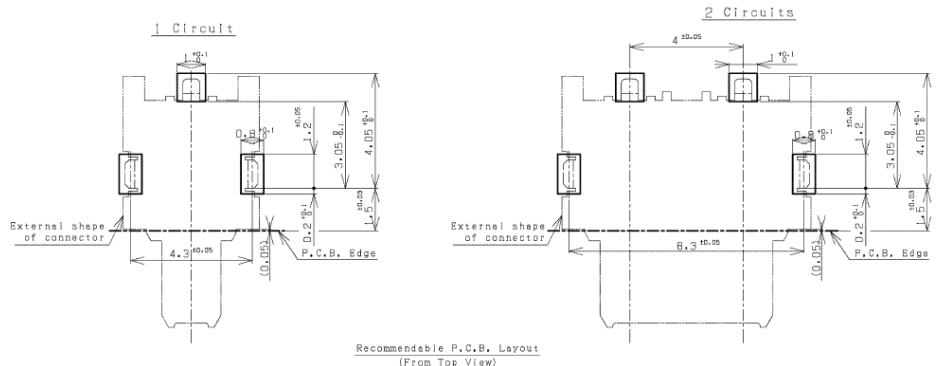

LEB connector

Receptacle SMT Headers

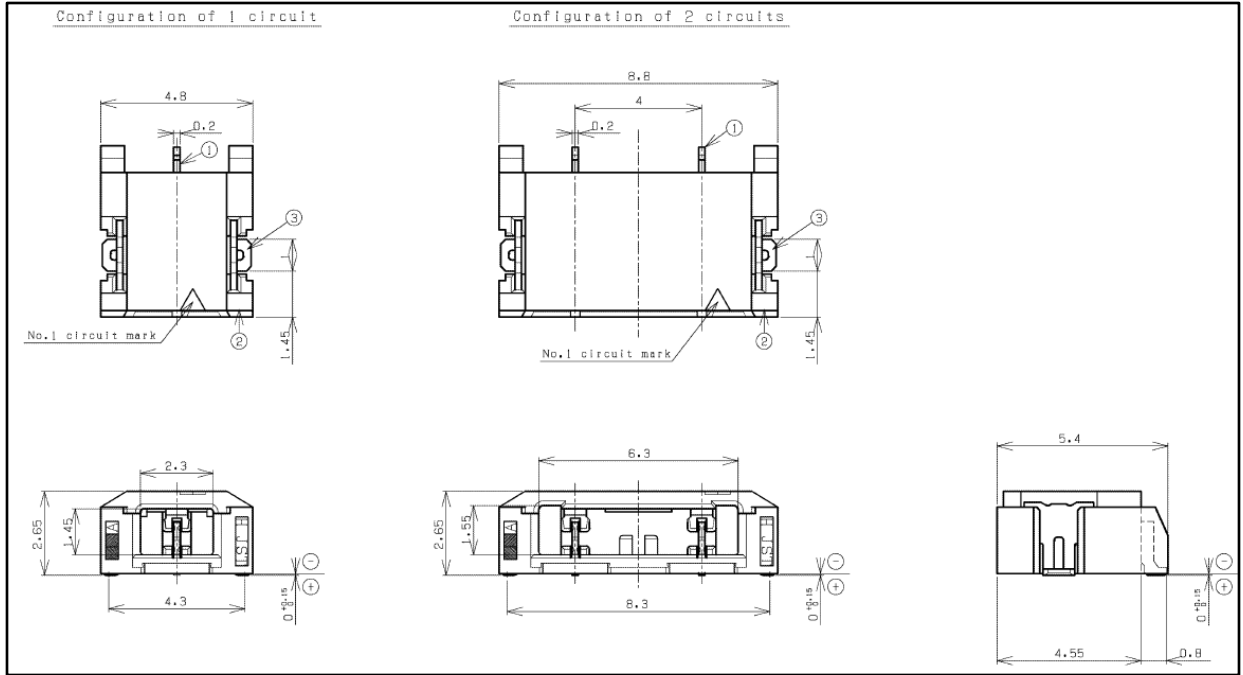

Circuits	Model No.	Qty./reel	Material and Finish
1	01R-LEBSS-TB (LF)(SN)	2,000	Copper alloy, tin plated, 9T Nylon UL 94v-0
2	02R-LEBSS-TB (LF)(SN)	2,000	

Plug SMT Headers

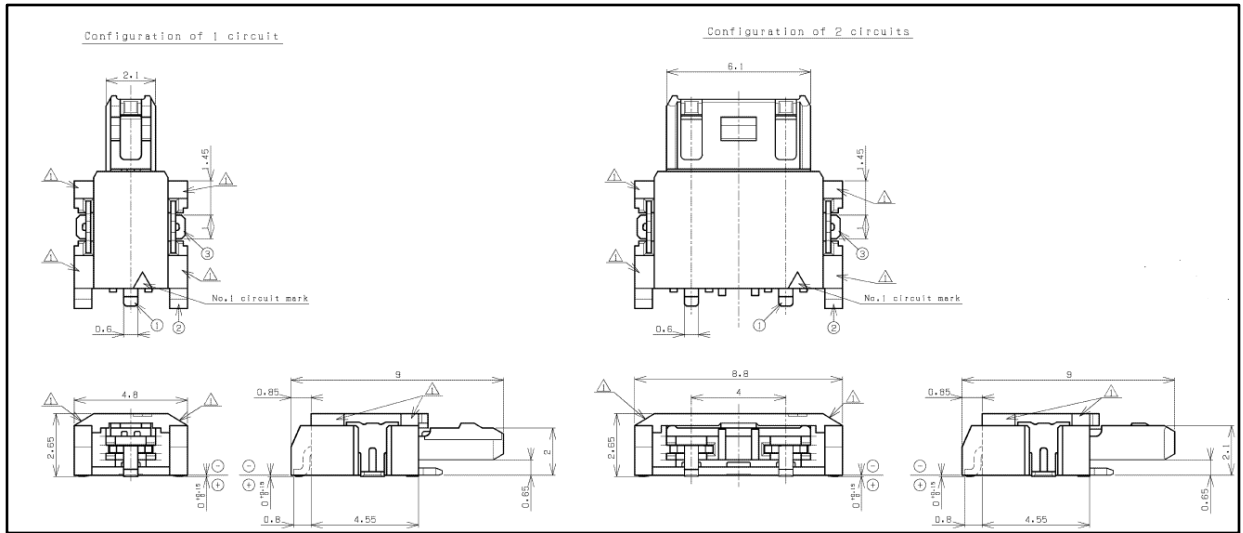

Circuits	Model No.	Qty./reel	Material and Finish
1	01P-LEBSS-TF (LF)(SN)	2,000	Copper alloy, tin plated, 9T Nylon UL 94v-0
2	02P-LEBSS-TF (LF)(SN)	2,000	