

# Mini control relays

K control relays  
Control circuit : a.c. or d.c.



References

## Mini control relays

- Mounted on 35 mm rail or Ø 4 mm screw fixing.
- Screws in open "ready-to-tighten" position.

Control circuit	Type of connection	Auxiliary contacts		Basic reference. Complete with code indicating control circuit voltage (2)	Weight kg			
		N/O	N/C					
a.c.	4.5 VA	Screw clamp	4	–	CA2-KN40●●	0.180		
			3	1	CA2-KN31●●	0.180		
			2	2	CA2-KN22●●	0.180		
		Faston	1 x 6.35	or 2 x 2.8	4	–	CA2-KN407●●	0.180
					3	1	CA2-KN317●●	0.180
					2	2	CA2-KN227●●	0.180
					Solder pins for printed circuit board	4	–	CA2-KN405●●
		3	1	CA2-KN315●●		0.210		
		d.c.	2.4 W	Screw clamp	4	–	CA3-KN40●●	0.225
					3	1	CA3-KN31●●	0.225
2	2				CA3-KN22●●	0.225		
Faston	1 x 6.35			or 2 x 2.8	4	–	CA3-KN407●●	0.225
					3	1	CA3-KN317●●	0.225
					2	2	CA3-KN227●●	0.225
					Solder pins for printed circuit board	4	–	CA3-KN405●●
3	1			CA3-KN315●●		0.255		
2	2	CA3-KN225●●	0.255					



CA2-KN40●●



CA3-KN407●●

## Low consumption mini control relays

- Compatible with PLC outputs.
- LED operation indicator incorporated.
- Wide range coil (0.7...1.30 Uc), suppressor fitted as standard.
- Mounting on 35 mm rail or Ø 4 mm screw fixing.
- Screws in open "ready-to-tighten" position.

d.c.	1.5 W	Screw clamp	4	–	CA4-KN40●●●	0.235		
			3	1	CA4-KN31●●●	0.235		
			2	2	CA4-KN22●●●	0.235		
		Faston	1 x 6.35	or 2 x 2.8	4	–	CA4-KN407●●●	0.235
					3	1	CA4-KN317●●●	0.235
					2	2	CA4-KN227●●●	0.235
					Solder pins for printed circuit board	4	–	CA4-KN405●●●
		3	1	CA4-KN315●●●		0.265		
		2	2	CA4-KN225●●●	0.265			

(2) Standard control circuit voltages (for other voltages, please consult your Regional customer centre).

CA2-K mini control relays (0.8...1.15 Uc) (0.85...1.1 Uc)

Volts ~	12	24	36	42	48	110	127	220/ 230	230/ 380/ 400	400/ 440	500	660/ 690				
Code	J7	B7	C7	D7	E7	F7	FC7	M7	P7	U7	Q7	V7	N7	R7	S7	Y7

Up to and including 240 V, coil with integral suppression device available: add 2 to the code required.  
Example: J72

CA3-K mini control relays (0.8...1.15 Uc)

Volts =	12	20	24	36	48	60	72	100	110	125	200	220	230	240	250
Code	JD	ZD	BD	CD	ED	ND	SD	KD	FD	GD	LD	MD	MPD	MUD	UD

Coil with integral suppression device available: add 3 to the code required. Example: JD3.

CA4-K, low consumption mini control relays (wide range coil: 0.7...1.3 Uc)

Volts =	12	24	48	72
Code	JW3	BW3	EW3	SW3

### Mini control relays CA2-K, CA3-K, CA4-K

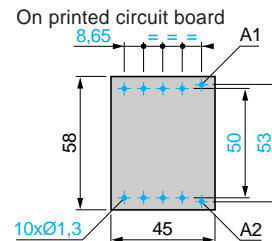
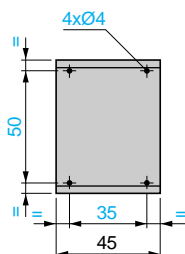
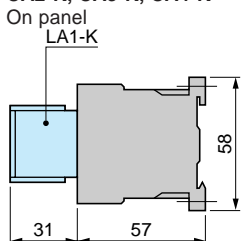



# Mini control relays

K control relays  
Instantaneous and time delay auxiliary contact blocks

## References

### Instantaneous auxiliary contact blocks

#### Clip-on front mounting, 1 block per mini control relay

Type of connection	Composition		Reference	Weight
				
	N/O	N/C		kg
<b>Screw clamp</b>	2	–	<b>LA1-KN20</b>	0.045
	–	2	<b>LA1-KN02</b> (1)	0.045
	1	1	<b>LA1-KN11</b> (2)	0.045
	4	–	<b>LA1-KN40</b> (3)	0.045
	3	1	<b>LA1-KN31</b> (3)	0.045
	2	2	<b>LA1-KN22</b> (3)	0.045
<b>Faston</b> 1 x 6.35 or 2 x 2.8	1	3	<b>LA1-KN13</b> (4)	0.045
	–	4	<b>LA1-KN04</b> (5)	0.045
	2	–	<b>LA1-KN207</b>	0.045
	–	2	<b>LA1-KN027</b>	0.045
	1	1	<b>LA1-KN117</b>	0.045
	4	–	<b>LA1-KN407</b> (3)	0.045
3	1	<b>LA1-KN317</b> (3)	0.045	
2	2	<b>LA1-KN227</b> (3)	0.045	
1	3	<b>LA1-KN137</b> (3)	0.045	
–	4	<b>LA1-KN047</b> (3)	0.045	



LA1-KN40

- (1) Cannot be used on control relays : CA4-KN22, CA4-KN31.  
 (2) Cannot be used on control relays : CA4-KN22.  
 (3) Cannot be used on control relays : CA4-KN●●●●●.  
 (4) Cannot be used on control relays : CA3-KN22, CA4-KN●●●●●.  
 (5) Cannot be used on control relays : CA3-KN22, CA3-KN31, CA4-KN●●●●●.

### Electronic time delay contact blocks

- Relay output with common point changeover contact, 2 A maximum
- Control voltage :  $\sim$  or  $\equiv$  24...48 V,  $\sim$  110...240 V, 0.85...1.1 U<sub>c</sub>
- Maximum switching capacity : 250 VA or 150 W
- Operating temperature : - 10...+ 60 °C
- Reset time : 1.5 s during the time delay period, 0.5 s after the time delay period.

#### Clip-on front mounting, 1 block per mini control relay

Voltage	Type	Timing range	Composition	Reference	Weight
					
V		s	C/O		kg
$\sim$ or $\equiv$ 24...48	On-delay	1...30	1	<b>LA2-KT2E</b>	0.040
$\sim$ 110...240	On-delay	1...30	1	<b>LA2-KT2U</b>	0.040

### Electronic time delay blocks LA2-KT

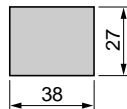
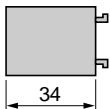

On mini control relays

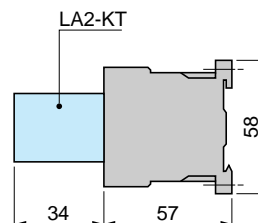

# Mini control relays

## K control relays Suppressor modules incorporating LED indicator

### References

1

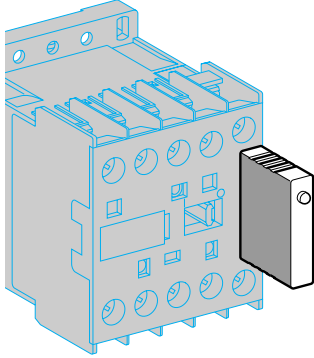

LA4-K●●●

Mounting and connection	Type	For voltages	Sold in lots of	Unit reference	Weight kg
Clips onto front of relay with locating device.	Varistor (1)	~ and --- 12...24 V	5	<b>LA4-KE1B</b>	0.010
		~ and --- 32...48 V	5	<b>LA4-KE1E</b>	0.010
		~ and --- 50...129 V	5	<b>LA4-KE1FC</b>	0.010
		~ and --- 130...250 V	5	<b>LA4-KE1UG</b>	0.010
		Diode	---	5	<b>LA4-KC1B</b>
	+ Zener diode (2)	12...24 V	5	<b>LA4-KC1E</b>	0.010
		32...48 V	5	<b>LA4-KC1E</b>	0.010
	RC (3)	~	5	<b>LA4-KA1U</b>	0.010
			220...250 V		

(1) Protection by limitation of the transient voltage to 2  $U_c$  max.  
Maximum reduction of transient voltage peaks.

Slight time delay on drop-out (1.1 to 1.5 times the normal time).

(2) No overvoltage or oscillation frequency.

Polarised component.

Slight time delay on drop-out (1.1 to 1.5 times the normal time).

(3) Protection by limitation of the transient voltage to 3  $U_c$  max. and limitation of the oscillation frequency.  
Slight time delay on drop-out (1.2 to 2 times the normal time).

### Suppressor modules LA4-K

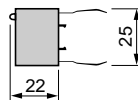

On mini control relays

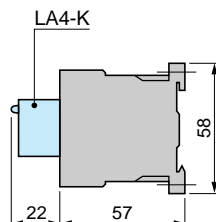

# Mini control relays

K control relays  
Mounting and marking accessories

## References

### Mounting accessories

Description	Application		Sold in lots of	Unit reference	Weight kg
<b>Mounting plates</b>	On 1 □ rail	Clip-on fixing	1	<b>LA9-D973</b>	0.025
	On 2 □ rails	110/120 mm fixing centres	10	<b>DX1-AP25</b>	0.065

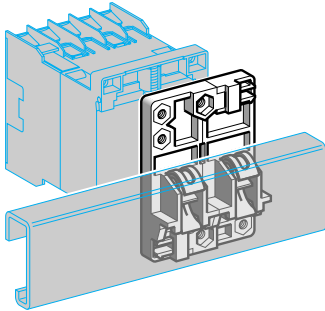

LA9-D973

### Marking accessories

Description	Application		Sold in lots of	Unit reference	Weight kg
<b>Marker holder</b>	Clip-on fixing	–	100	<b>LA9-D90</b>	0.001
<b>Clip-in markers</b>	4 maximum per relay	Strips of 10 identical numbers 0 to 9	25	<b>AB1-R●</b> (1)	0.002
		Strips of 10 identical capital letters A to Z	25	<b>AB1-G●</b> (1)	0.002

(1) Complete the reference with the required character.

On asymmetrical rail with clip-on mounting plates  
**LA9-D973**

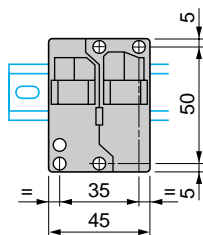
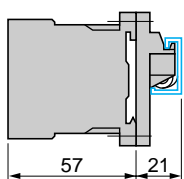

**DX1-AP25**

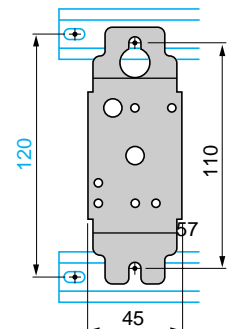
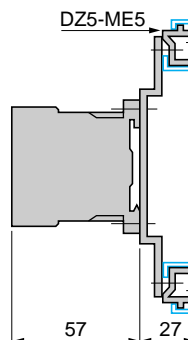

# Control relays

CA2-D and CA3-D  
Control circuit : a.c.



References

1



CA2-DK22●●



CA2-DN31●●

Control circuit : a.c.

Type	Number of contacts	Composition		Basic reference. Complete with code indicating control circuit voltage (2)	Weight kg
Instantaneous	4	4	—	CA2-DN40●●	0.320
		3	1	CA2-DN31●●	0.320
		2	2	CA2-DN22●●	0.320
		2	2	CA2-DC22●●	0.320
		including 1 N/O and 1 N/C make before break			
Mechanical latch/memory	4	2	2	CA2-DK22●●	0.580

### Specifications

Protective treatment	"TH" as standard
Fixing	On 35 mm rail or Ø 4 mm screw fixing
Cabling	By screw clamp terminals
Terminals	Protected against direct finger contact with ready-to-tighten captive screws (1)

Marking and contact positions conforming to CENELEC EN 50005, EN 50011.

(1) Telemecanique patented system which prevents screws from tightening themselves (e.g. due to vibration during transport).

(2) Standard control circuit voltages (for other voltages, please consult your Regional customer centre).

Volts ~	24	42	48	110	220/230	230	240	380/400	400	415	440	500	660
50 Hz	B5	D5	E5	F5	M5	P5	U5	Q5	V5	N5	R5	S5	Y5
60 Hz	B6	—	E6	F6	M6	—	U6	Q6	—	N6	R6	—	—
50/60 Hz	B7	D7	E7	F7	M7	P7	U7	Q7	V7	N7	R7	—	—

### CA2-DN, DC

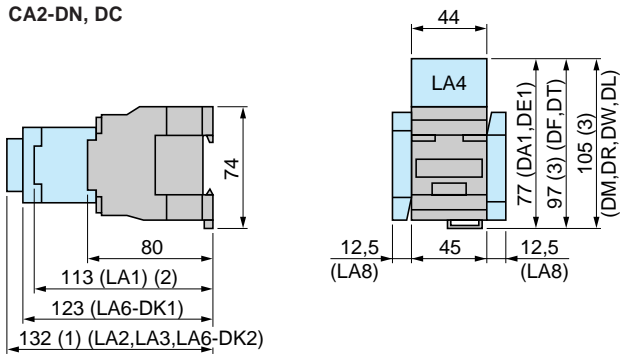

(1) + 4 mm with lead sealing kit LA9-D901

(2) With 2 or 4 contacts

(3) With or without combined use of coil suppressor module : LA4-DA1●, DE1●

### CA2-DK22

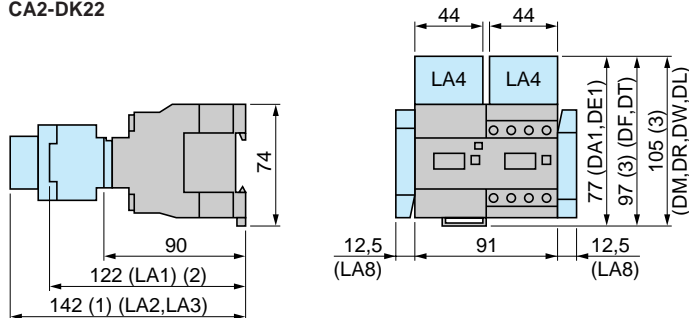

(1) + 4 mm with lead sealing kit LA9-D901

(2) With 2 or 4 contacts

(3) With or without combined use of coil suppressor module LA4-DA1●, DE1●

### CA2, CA3-DN, DC, DK Panel mounting

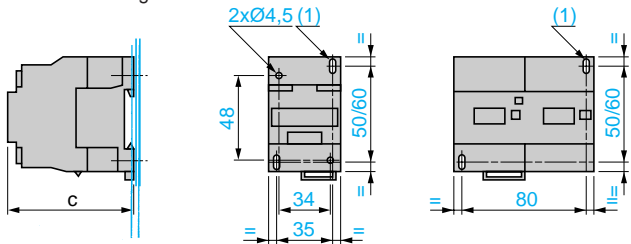

c	CA2-			CA3-		
	DN	DC	DK	DN	DC	DK
	80	80	90	115	115	125

(1) 2 elongated holes 4.5 x 9

### CA2, CA3-DN, DC, DK

Mounting on rail AM1-DP200 or DE200

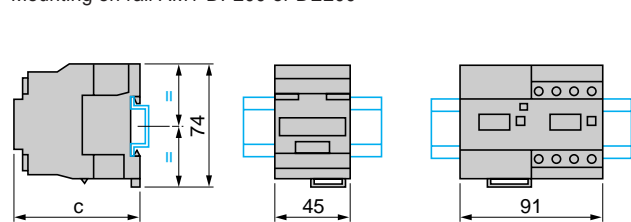

c	CA2-			CA3-		
	DN	DC	DK	DN	DC	DK
(AM1-DP200)	82	82	91	117	117	127
(AM1-DE200)	89	89	98	124	124	134

# Control relays

CA2-D and CA3-D  
Control circuit : d.c.

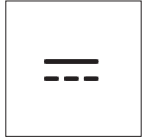

References

Control circuit : d.c.



CA3-DK22●●



CA3-DN31●●

Type	Number of contacts	Composition		Basic reference. Complete with code indicating control circuit voltage (2)	Weight kg
Instantaneous	4	4	–	CA3-DN40●●	0.320
		3	1	CA3-DN31●●	0.320
		2	2	CA3-DN22●●	0.320
		2	2	CA3-DC22●●	0.320
		including 1 N/O and 1 N/C make before break			
Mechanical latch/memory	4	2	2	CA3-DK22●●	0.580

**Specifications**

Protective treatment	"TH" as standard
Fixing	On 35 mm rail or Ø 4 mm screw fixing
Cabling	By screw clamp terminals
Terminals	Protected against direct finger contact with ready-to-tighten captive screws (1)

Marking and contact positions conforming to CENELEC EN 50005, EN 50011.  
(1) Telemecanique patented system which prevents screws from tightening themselves (e.g. due to vibration during transport).

(2) Standard control circuit voltages (for other voltages, please consult your Regional customer centre).

Volts ---	12	24	36	48	60	72	110	125	220	250	440
U from 0.8 to 1.1 Uc	JD	BD	CD	ED	ND	SD	FD	GD	MD	UD	RD
U from 0.7 to 1.25 Uc	JW	BW	CW	EW	–	SW	FW	–	MW	–	–

CA3-DN, CA3-DC

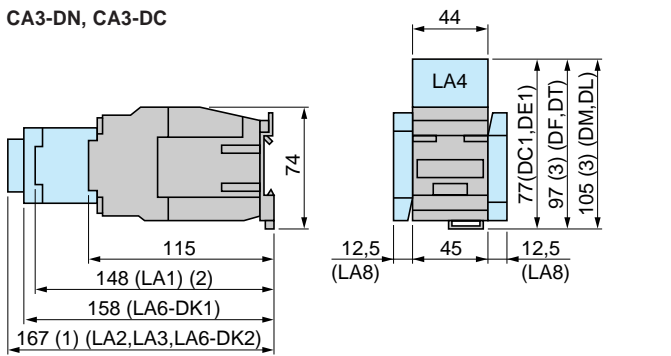

- (1) + 4 mm with lead sealing kit LA9-D901
- (2) With 2 or 4 contacts
- (3) With or without combined use of coil suppressor module LA4-DC1●, DE1●

CA3-DK22

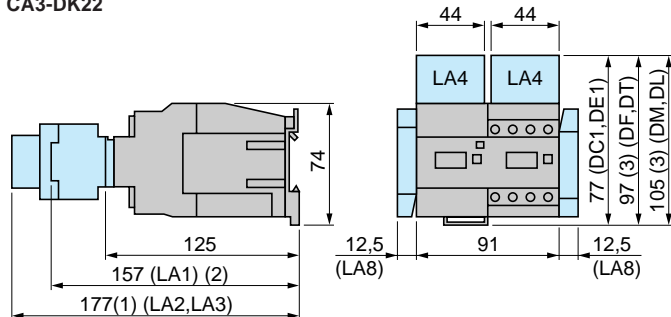

- (1) + 4 mm with lead sealing kit LA9-D901
- (2) With 2 or 4 contacts
- (3) With or without combined use of coil suppressor module LA4-DC1●, DE1●

CA2, CA3-DN, DC, DK  
Mounting on plate AM1-P

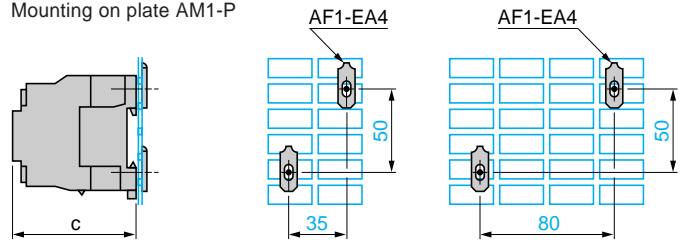

c (AM1-P)	CA2-			CA3-		
	DN	DC	DK	DN	DC	DK
	80	80	90	115	115	125

Delayed capacitive opening devices  
LA9-Z90●

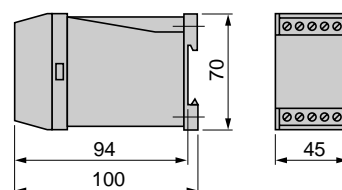

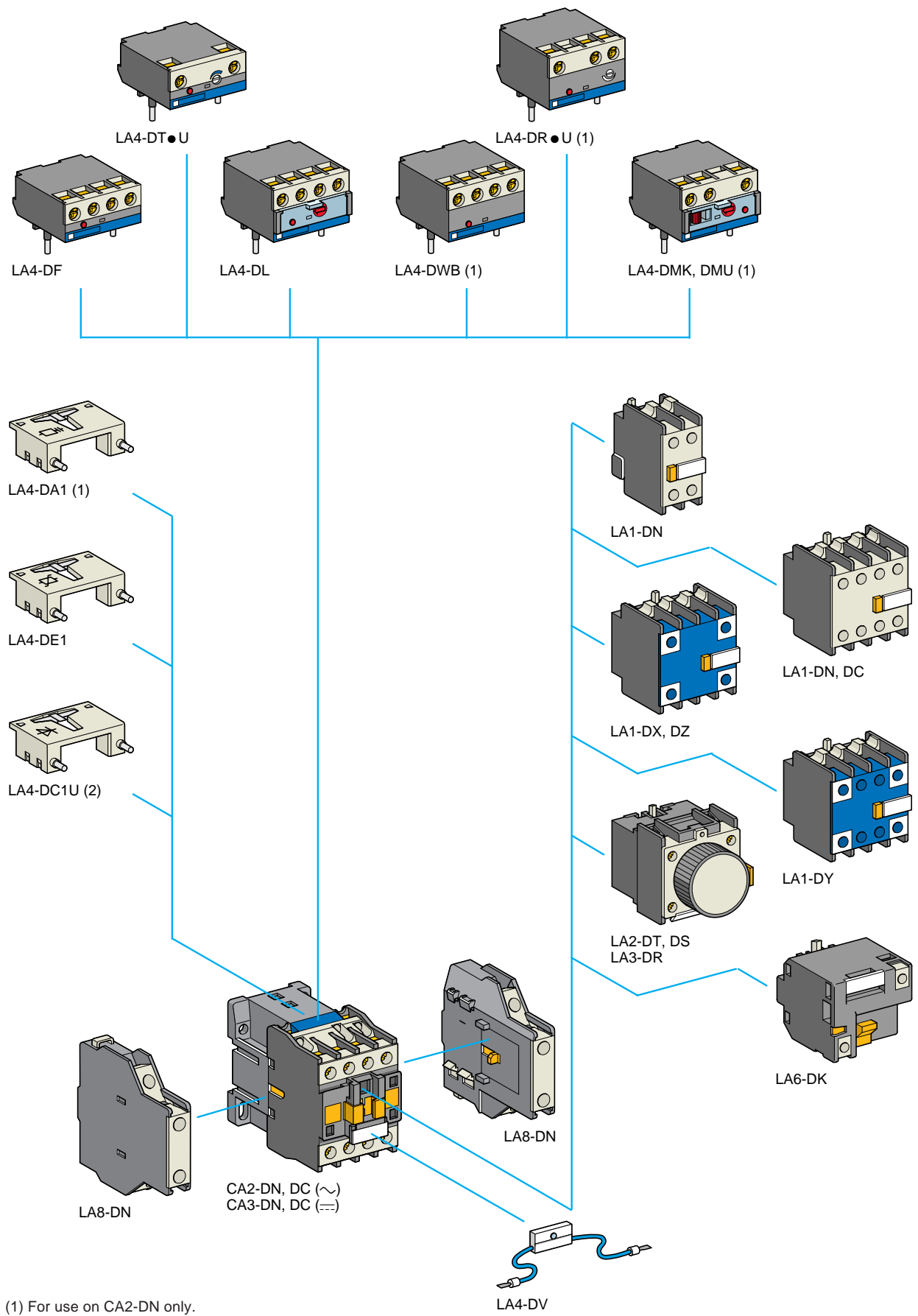

(1) For use on CA2-DN only.  
(2) For use on CA3-DN only.



# Control relays

## CA2 and CA3-D Add-on auxiliary contact blocks and mechanical latch blocks

Illustrations :  
page 1/176  
Dimensions :  
pages 1/174 and 1/175





### References

#### Instantaneous auxiliary contact blocks

Number of contacts	Maximum number per relay (1)		Composition		Reference	Weight kg
	Clip-on mounting front	side				
<b>For standard applications</b>						
2	1	–	1	1	LA1-DN11	0.030
	–	2	1	1	LA8-DN11	0.030
	1	–	2	–	LA1-DN20	0.030
	–	2	2	–	LA8-DN20	0.030
	1	–	–	2	LA1-DN02	0.030
4	1	–	2	2	LA1-DN22	0.050
			1	3	LA1-DN13	0.050
			4	–	LA1-DN40	0.050
			–	4	LA1-DN04	0.050
			3	1	LA1-DN31	0.050
			2	2 (3)	LA1-DC22	0.050

#### Instantaneous auxiliary contact blocks (with dust and damp protected contacts)

##### For use in particularly harsh industrial environments

Number of contacts	Maximum number per relay (1) Front mounting	Composition				Reference	Weight kg
							
protected (4)							
2	1	2	–	–	–	LA1-DX20	0.040
		2	2	–	–	LA1-DY20	0.040
4	1	2	–	2	–	LA1-DZ40	0.050
		2	–	1	1	LA1-DZ31	0.050

#### Time delay auxiliary contact blocks

Number and type of contacts	Maximum number per relay (1) Front mounting	Time delay Type	Range	Reference	Weight kg
			0.1...30 s	LA2-DT2	0.060
			10...180 s	LA2-DT4	0.060
			1...30 s (6)	LA2-DS2	0.060
		Off-delay	0.1...3 s (5)	LA3-DR0	0.060
			0.1...30 s	LA3-DR2	0.060
			10...180 s	LA3-DR4	0.060

(Sealing kit : see page 1/179)

#### Mechanical latch blocks

Tripping control	Maximum number per relay (1) Front mounting	Basic reference. Complete with voltage code (2)	Weight kg
<b>Manual or electric</b>	1	LA6-DK10●	0.070

(1) Maximum mounting possibility (see below).

Type of device	Type of coil	For guaranteed operation from	Max. number of add-on blocks Clip-on mounting	
			front	side
CA2-D	50 or 60 Hz	0.8...1.1 Uc	1	2
	50/60 Hz	0.8...1.1 Uc	1	2
		0.85...1.1 Uc	1	2
CA3-D	≡	0.8...1.1 Uc	1	2
	≡ (wide range)	0.7...1.25 Uc	1	2

(2) Standard control circuit voltages (for other voltages, please consult your Regional customer centre).  
Volts ~ or ≡ 12 24 32/36 42/48 60/72 100 110/127 220/240 255/277 380/415

Code J B C E EN K F M U Q

(3) Including 1 N/O and 1 N/C make before break.

(4) Device fitted with 4 screening continuity terminals.

(5) With extended scale from 0.1 to 0.6 s.

(6) With switching time of 40 ms ± 15 ms between opening of the N/C contact and closing of the N/O contact (suitable for use with star-delta circuits).



# Control relays

## CA2-D and CA3-D

Interface, control modules and delayed capacitive opening devices

Illustrations :  
page 1/176  
Dimensions :  
pages 1/174 and 1/175

## References

1



LA4-DR0U



LA4-DFE



LA4-DLE



LA4-DMU



LA4-DVM

## Electronic serial timer modules

Type	Mounted at top on	Time delay	Reference	Weight kg
On-delay	CA2-D, CA3-D	0.1...2 s	LA4-DT0U	0.040
		1.5...30 s	LA4-DT2U	0.040
		25...500 s	LA4-DT4U	0.040
Off-delay	CA2-D	0.1...2 s	LA4-DR0U	0.050
		1.5...30 s	LA4-DR2U	0.050
		25...500 s	LA4-DR4U	0.050

## Amplifier interface modules

Type	Mounted at top on	Supply voltage (1) of module	of control relay	Reference	Weight kg
Relay interface	CA2-D, CA3-D	≡ 24 V	24...250 V	LA4-DFB	0.050
		≡ 48 V	24...250 V	LA4-DFE	0.050
	CA2-D	≡ 24 V	380...415 V	LA4-DFBQ	0.055
Relay interface with manual override switch (output forced "ON")	CA2-D, CA3-D	≡ 24 V	24...250 V	LA4-DLB	0.045
		≡ 48 V	24...250 V	LA4-DLE	0.045
Solid state	CA2-D	≡ 24 V		LA4-DWB	0.045

## "Auto-Manual-Stop" control modules

### For local override operation tests with 2-position "Auto-Man" switch and "O-I" switch

Description	Mounted at top on	Control relay supply voltage	Reference	Weight kg
With "O-I" switch and 2-position "Auto-Man" switch	CA2-D, CA3-D	24/100 V	LA4-DMK	0.040
	CA2-D	100/250 V	LA4-DMU	0.040

## Indicators

Type	Clips into legend plate location on	Control relay supply voltage	Sold in lots of	Unit reference	Weight kg
Red LED	CA2-D, CA3-D	12/72 V	5	LA4-DVE	0.010
		72/250 V	5	LA4-DVM	0.010
		250/440 V	5	LA4-DVR	0.010

## Delayed capacitive opening devices

### For use on control relays CA3-D to prevent inadvertent opening in the event of a brief volt drop or momentary supply failure

Supply voltage 50/60 Hz	Control relay reference. To be completed (2)	Replacement coil reference	Corresponding delayed opening device Delay time (Tr) Non adjustable	Reference	Weight kg
110-115 V	CA3-DN●●PD	LX4-D2PD	1...3 s	LA9-Z90F	0.215
120-127 V	CA3-DN●●QD	LX4-D2QD	1.5...3 s	LA9-Z90F	0.215
220 V	CA3-DN●●TD	LX4-D2TD	2.5...5 s	LA9-Z90M	0.215
240 V	CA3-DN●●VD	LX4-D2VD	3...6 s	LA9-Z90M	0.215
380 V	CA3-DN●●WD	LX4-D2WD	2.5...5 s	LA9-Z90Q	0.215
415-440 V	CA3-DN●●XD	LX4-D2XD	3.5...8 s	LA9-Z90Q	0.215

## Accessories (to be ordered separately)

Description	Reference	Weight kg
<b>Add-on block for doubling the time delay</b> Example : LA9-Z90F = 1 to 3 s LA9-Z90F + LA9-Z91F = 1 to 6 s	LA9-Z91● (3)	0.215

(1) For 24 V, the control relay must be fitted with a 21 V coil. See page 1/180.

(2) See page 1/175.

(3) Replace ● in reference with required voltage code; this will be the same as the code for the delayed opening device.

# Control relays

## CA2-D and CA3-D Coil suppressor modules and accessories

Illustrations :  
page 1/176  
Dimensions :  
pages 1/174 and 1/175

### References

#### Coil suppressor modules

These modules clip onto the top of the control relay and the electrical connection is instantly made. Fitting of an input module is still possible.

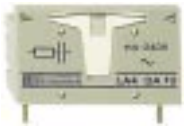

LA4-DA1●



LA4-DE1●

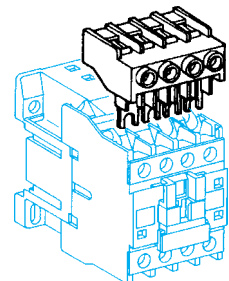

LA9-D1260

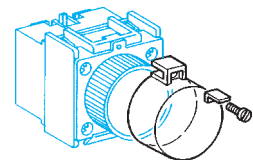

LA9-D901

#### RC circuits (Resistor-Capacitor) (1)

For mounting on	Operational voltage	Reference	Weight kg
CA2-DN (2)	~ 24/48 V	<a href="#">LA4-DA1E</a>	0.012
	~ 50/127 V	<a href="#">LA4-DA1G</a>	0.012
	~ 110/240 V	<a href="#">LA4-DA1U</a>	0.012

#### Varistors (peak limiting) (3)

CA2-DN, CA3-DN (2)	~ or ~ 24/48 V	<a href="#">LA4-DE1E</a>	0.012
	~ or ~ 50/127 V	<a href="#">LA4-DE1G</a>	0.012
	~ or ~ 110/250 V	<a href="#">LA4-DE1U</a>	0.012

#### Diode (4)

CA3-DN (2)	~ 24/250 V	<a href="#">LA4-DC1U</a>	0.012
------------	------------	--------------------------	-------

#### Accessories (to be ordered separately)

##### For connection

Description	For mounting on	Reference	Weight kg
<b>4-pole connector</b> for connection of 10 mm <sup>2</sup> cables	CA2-DN, CA3-DN	<a href="#">LA9-D1260</a>	0.030

##### For marking

For mounting on	Description	Sold in lots of	Unit reference	Weight kg
<b>CA2-DN, CA3-DN and add-on blocks</b> except LA1-DN (2 contacts)	Clip-in marker holder 8 x 22 mm	100	<a href="#">LA9-D92</a>	0.001
	Bag of 300 blank self-adhesive labels 7 x 21 mm	1	<a href="#">LA9-D93</a>	0.001
<b>LA1-DN (2 contacts)</b>	Clip-in marker holder 8 x 17 mm	100	<a href="#">LA9-D90</a>	0.001
	Bag of 400 blank self-adhesive labels 7 x 16 mm	1	<a href="#">LA9-D91</a>	0.001

##### For sealing

Description	For mounting on	Reference	Weight kg
<b>Sealing kit</b>	LA2-D, LA3-D	<a href="#">LA9-D901</a>	0.005

(1) An RC circuit provides effective protection for circuits highly sensitive to high frequency interference. Voltage limited to 3 Uc maximum, oscillating frequency limited to 400 Hz maximum. Slight increase in drop-out time (1.2 to 2 times the usual time).

(2) For satisfactory protection, a suppressor module must be fitted across the coil of each control relay. (3) Protection is provided by limiting the transient voltage value to 2 Uc maximum. Maximum reduction of transient voltage peaks. Slight increase in drop-out time (1.1 to 1.5 times the usual time).

(4) Protection is provided by a polarised component; no overvoltage or oscillating frequency. Slight increase in drop-out time (6 to 10 times the usual time).

# Control relays

Coils for CA2-D, a.c. control supply



## References

1

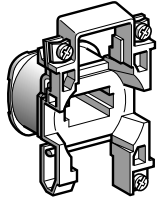

LX1-D2●●

Control circuit voltage U <sub>c</sub>	Average resistance at 20 °C ± 10 %	Inductance of closed circuit	Reference (1)	Average resistance at 20 °C ± 10 %	Inductance of closed circuit	Reference (1)	Weight
				Ω	H		
V	Ω	H		Ω	H		kg
			50 Hz	60 Hz			
21 (2)	6.3	0.26	LX1-D2Z5	4.98	0.21	LX1-D2Z6	0.070
24	6.82	0.3	LX1-D2B5	5.45	0.25	LX1-D2B6	0.070
32	12.26	0.48	LX1-D2C5	—	—	—	0.070
42	21.32	0.93	LX1-D2D5	—	—	—	0.070
48	28.05	1.22	LX1-D2E5	22.09	1.02	LX1-D2E6	0.070
110	148.2	5.7	LX1-D2F5	116.6	4.5	LX1-D2F6	0.070
120	—	—	—	139.2	5.1	LX1-D2G6	0.070
127	192.5	7.5	LX1-D2G5	—	—	—	0.070
208	—	—	—	417.8	16.6	LX1-D2L6	0.070
220	—	—	—	490.2	18.5	LX1-D2M6	0.070
220/230	613.3	23	LX1-D2M5	—	—	—	0.070
230	649.7	25	LX1-D2P5	—	—	—	0.070
240	726.6	25	LX1-D2U5	587.4	21	LX1-D2U6	0.070
256	816	31	LX1-D2W5	—	—	—	0.070
277	—	—	—	781.5	30	LX1-D2W6	0.070
380	—	—	—	1486	55	LX1-D2Q6	0.070
380/400	1848	67	LX1-D2Q5	—	—	—	0.070
400	2069	68	LX1-D2V5	—	—	—	0.070
415	2219	78	LX1-D2N5	1826	69	LX1-D2N6	0.070
440	2549	82	LX1-D2R5	1892	71	LX1-D2R6	0.070
480	—	—	—	2304	85	LX1-D2T6	0.070
500	3285	107	LX1-D2S5	—	—	—	0.070
575	—	—	—	3482	119	LX1-D2S6	0.070
600	—	—	—	3678	135	LX1-D2X6	0.070
660	5631	190	LX1-D2Y5	—	—	—	0.070

## Specifications

Average consumption at 20 °C :  
 - inrush (cos φ = 0.75) 50 Hz : 60 VA; 60 Hz : 70 VA,  
 - sealed (cos φ = 0.3) 50 Hz : 7 VA; 60 Hz : 7.5 VA.  
 Operating range (θ ≤ 55 °C) : 0.8 to 1.1 U<sub>c</sub>

50/60 Hz							
Control circuit voltage U <sub>c</sub>	Average resistance at 20 °C ± 10 %	Inductance of closed circuit	Reference (1)	Average resistance at 20 °C ± 10 %	Inductance of closed circuit	Reference (1)	Weight
V	Ω	H		Ω	H		kg
21 (2)	—	—	—	5.6	0.24	LX1-D2Z7	0.070
24	—	—	—	6.19	0.26	LX1-D2B7	0.070
42	—	—	—	19.15	0.77	LX1-D2D7	0.070
48	—	—	—	25	1	LX1-D2E7	0.070
110	—	—	—	130	5.5	LX1-D2F7	0.070
120	—	—	—	159	6.7	LX1-D2G7	0.070
220/230	—	—	—	539	22	LX1-D2M7 (3)	0.070
230	—	—	—	595	21	LX1-D2P7	0.070
230/240	—	—	—	645	25	LX1-D2U7 (4)	0.070
380/400	—	—	—	1580	60	LX1-D2Q7	0.070
400	—	—	—	1810	64	LX1-D2V7	0.070
415	—	—	—	1938	74	LX1-D2N7	0.070
440	—	—	—	2242	79	LX1-D2R7	0.070

## Specifications

Average consumption at 20 °C :  
 - inrush (cos φ = 0.75) 50/60 Hz : 70 VA at 50 Hz,  
 - holding (cos φ = 0.3) 50/60 Hz : 8 VA at 60 Hz.  
 Operating range (θ ≤ 55 °C) : 0.85 to 1.1 U<sub>c</sub>

- (1) The last two digits in the reference represent the voltage code.  
 (2) Voltage for special coils fitted in contactors with serial timer modules, with 24 V supply.  
 (3) This coil can be used on 240 V at 60 Hz.  
 (4) This coil can be used on 230/240 V at 50 Hz and on 240 V only at 60 Hz.

# Control relays

Coils for CA3-D, d.c. control supply

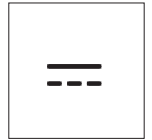

## References

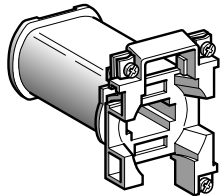

LX4-D2●●

Control circuit voltage Uc	Average resistance at 20 °C ± 10 %	Inductance of closed circuit	Reference (1)	Weight
V	Ω	H		kg

### Standard coils

12	17	0.79	LX4-D2JD	0.175
21 (2)	45.4	2.16	LX4-D2ZD	0.175
24	71	3.1	LX4-D2BD	0.175
36	149.7	7.1	LX4-D2CD	0.175
48	267	11.9	LX4-D2ED	0.175
60	422	19	LX4-D2ND	0.175
72	609	26	LX4-D2SD	0.175
96	1049	46	LX4-D2DD	0.175
100	1105	49.6	LX4-D2KD	0.175
110	1411	61.8	LX4-D2FD	0.175
125	1781	77.8	LX4-D2GD	0.175
155	2763	119	LX4-D2PD	0.175
174	3480	152	LX4-D2QD	0.175
200	4280	184	LX4-D2LD	0.175
220	5235	221	LX4-D2MD	0.175
250	6433	271	LX4-D2UD	0.175
305	9778	401	LX4-D2TD	0.175
348	12 479	512	LX4-D2VD	0.175
440	19 785	793	LX4-D2RD	0.175
543	31 785	1261	LX4-D2WD	0.175
600	38 982	1393	LX4-D2XD	0.175

### Specifications

Average consumption at 20 °C : 9 W  
Operating range ( $\theta \leq 55$  °C) : 0.8 to 1.1 Uc

### Wide range coils

12	15.6	0.71	LX4-D2JW	0.175
24	58.7	2.49	LX4-D2BW	0.175
36	122.6	5.3	LX4-D2CW	0.175
48	234	9.9	LX4-D2EW	0.175
72	530	21.4	LX4-D2SW	0.175
96	886	36.6	LX4-D2DW	0.175
110	1105	44.4	LX4-D2FW	0.175
220	4593	185	LX4-D2MW	0.175

### Specifications

Average consumption 20 °C : 11 W  
Operating range ( $\theta \leq 55$  °C) : 0.7 to 1.25 Uc

(1) The last two digits in the reference represent the voltage code.

(2) Voltage for special coils fitted in contactors with serial timer modules, with 24 V supply.