

Turned contacts turned crimp male contact for wire gauge 14

Part No. VN 01 025 0032 (1)C



Series Contacts

Subseries Contact Turned contacts

COMMON CHARACTERISTICS

Wire gauge from		2,5
Wire gauge (AWG) from		14
Packaging / supplied as		Single contact
No. of pieces		100
Sex of Contact		Pin
Type of contact		Turned crimp contact

ELECTRICAL CHARACTERISTICS

Contact resistance	DIN EN 60512-2-1, Test 2a / IEC 60512-2-1, Test 2a	0 m
--------------------	--	-----

Turned contacts turned crimp male contact for wire gauge 14

Part No. VN 01 025 0032 (1)C

Series Contacts

Subseries Contact Turned contacts

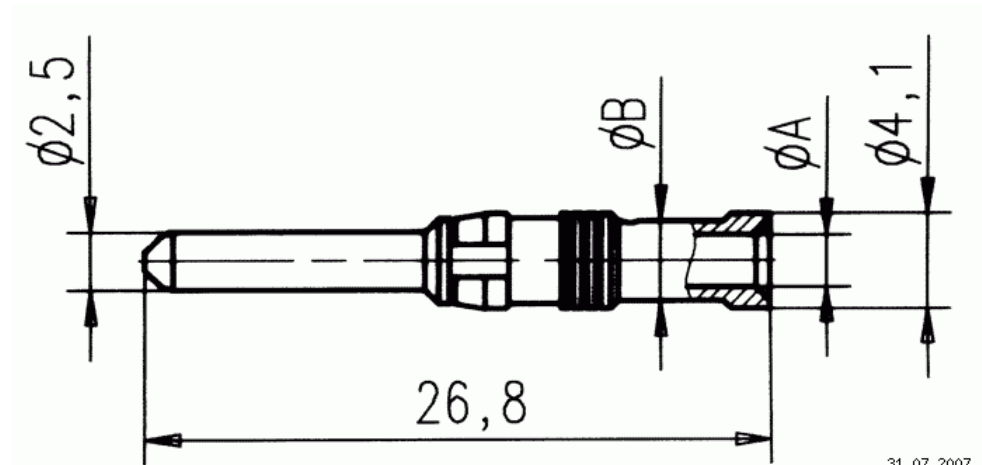

Ma zeichnung Dimensions in mm (Inch)

31.07.2007