

Turned contacts turned crimp female contact for wire gauge 10

Part No. VN 02 036 0002 (1)C



Series Contacts

Subseries Contact Turned contacts

COMMON CHARACTERISTICS		
Wire gauge from		6,0
Wire gauge (AWG) from		10
Packaging / supplied as		Single contact
No. of pieces		100
Sex of Contact		Socket
Type of contact		Turned crimp contact
ELECTRICAL CHARACTERISTICS		
Contact resistance	DIN EN 60512-2-1, Test 2a / IEC 60512-2-1, Test 2a	0 m

Turned contacts turned crimp female contact for wire gauge 10

Part No. VN 02 036 0002 (1)C

Series Contacts

Subseries Contact Turned contacts

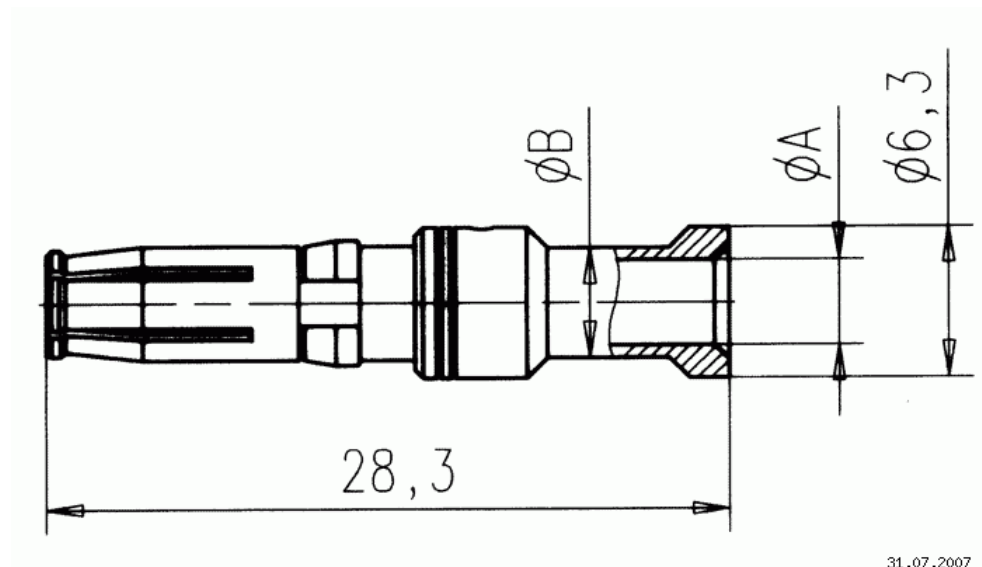

Ma zeichnung Dimensions in mm (Inch)

31.07.2007