

AEDR-850x

3 Channel Reflective Incremental Encoders

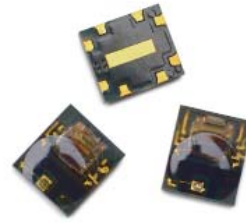

Data Sheet



Description

The AEDR-850X encoder is the smallest 3 channels optical encoder with digital outputs in the market employing reflective technology for motion control purposes. The encoder is designed to operate over -20°C to 85°C temperature range and hence suitable for both commercial and even industrial end applications.

The encoder houses an LED light source and a photo-detecting circuitry in a single package. The small size of $3.95\text{ mm (L)} \times 3.4\text{ mm (W)} \times 0.9562\text{ mm (H)}$, allows it to be even used in a wide range of miniature commercial application where size and space is a primary concern.

The AEDR-850X encoder offers two-channel quadrature digital outputs and a 3rd channel, index digital outputs. Being TTL compatible, the outputs of the AEDR-850X encoder can be interfaced directly with most of the signal processing circuitries. Hence the encoder provides great design-in flexibility and easy integration into existing systems.

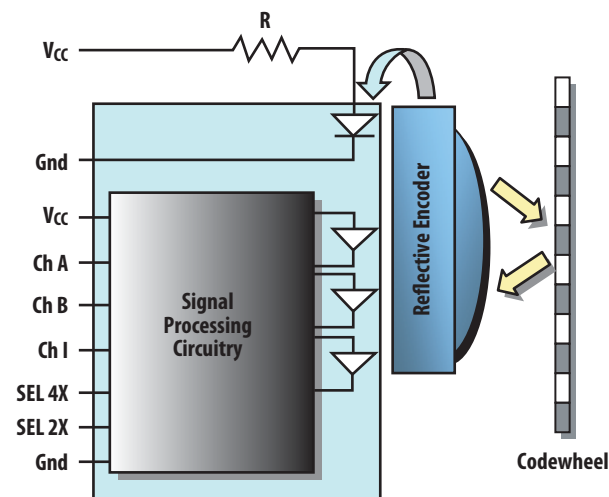

Note: Drawing not to scale.

Features

- World smallest 3 channels reflective technology encoder.
- Surface mount leadless package $3.95\text{ mm (L)} \times 3.4\text{ mm (W)} \times 0.9562\text{ mm (H)}$
- 3 channels; two channel quadrature digital outputs for direction sensing and a 3rd channel, Index digital output.
- Build in interpolator, factor of 1x, 2x and 4x selectable via external pinouts
- TTL compatible
- Single 5 V supply
- -20°C to 85°C absolute operating temperature
- Encoding resolution: 294 to 304 (lines/inch)

Applications

Ideal for high volume applications:

- Close Loop stepper Motors
- Miniature Motors
- Printers
- Copiers
- Card readers
- Scanners
- Projectors
- Consumer and Industrial Product Applications

Note: Avago Technologies encoders are not recommended for use in safety critical applications, e.g., ABS braking systems, power steering, life support systems and critical care medical equipment. Avago's products and software are not specifically designed, manufactured or authorized for sale as parts, components or assemblies for the planning, construction, maintenance or direct operation of a nuclear facility or for use in medical devices or applications. Customers are solely responsible, and waive all rights to make claims against Avago or its suppliers, for all losses, damage, expense or liability in connection with such use. Please contact your local sales representative if more clarification is needed.

Output waveform

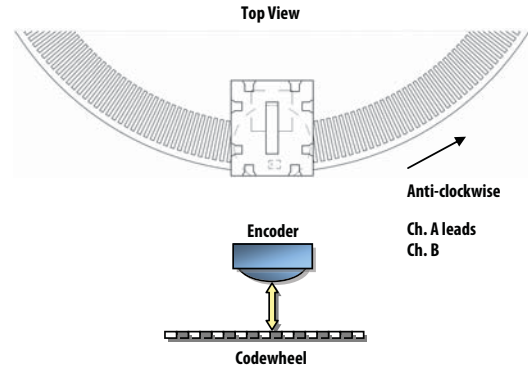
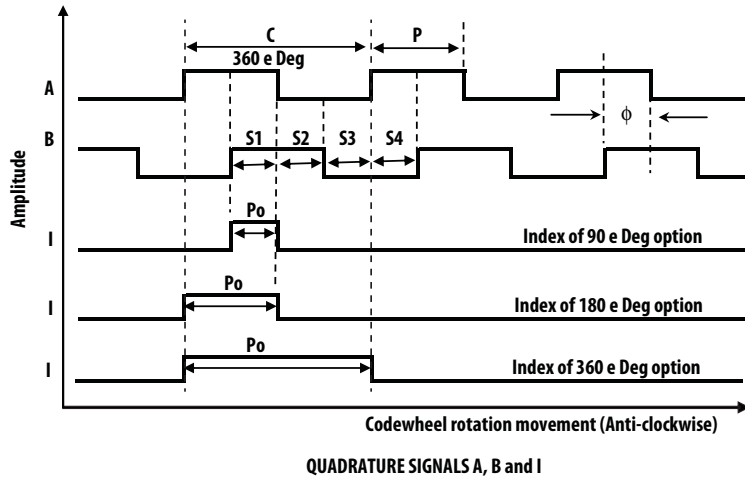

Note: Drawing not to scale.

Absolute Maximum Ratings

Storage Temperature, T_S	-20° C to 85° C
Operating Temperature, T_A	-20° C to 85° C
Supply Voltage, V_{CC}	7 V
Output Voltage, V_O	V_{CC}

Notes:

1. Exposure to extreme light intensity (such as from flashbulbs or spotlights) may cause permanent damage to the device.
2. CAUTION: It is advised that normal static precautions should be taken when handling the encoder in order to avoid damage and/or degradation induced by ESD.
3. Proper operation of the encoder cannot be guaranteed if the maximum ratings are exceeded.

Recommended Operating Conditions (based on limited prototype samples testing @ 11.38 Rop codewheel)

Parameter	Sym.	Min.	Typ.	Max.	Units	Notes
Temperature	T_A	-20	25	85	°C	
Supply Voltage	V_{CC}	4.5	5	5.5	V	Ripple < 100mVp-p
LED Current	I_{LED}		15mA		mA	See note 1
Count Frequency ²	F		55		kHz	1 x Interpolation Factor
Radial Misalignment	E_R			±0.2	mm	
Tangential Misalignment	E_T			±0.2	mm	
Codewheel Gap	G	0.5	1.0	1.25	mm	See note 3

Notes:

1. LED Current Limiting Resistor: Recommended series resistor = 180 Ω ($\pm 1\%$)
2. Count frequency = velocity (rpm) x CPR / 60.
3. Avago recommends 1.0mm gap as nominal.

Encoder Pin-Out

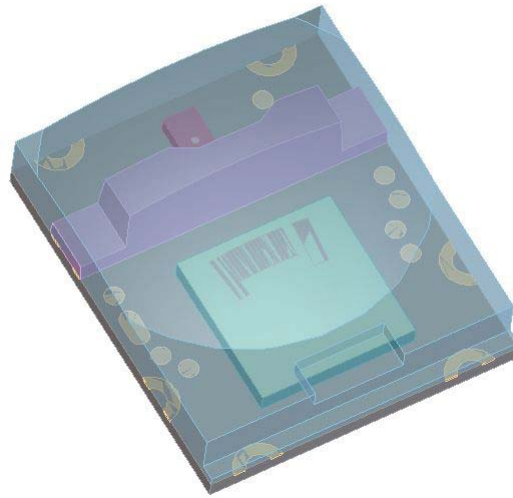
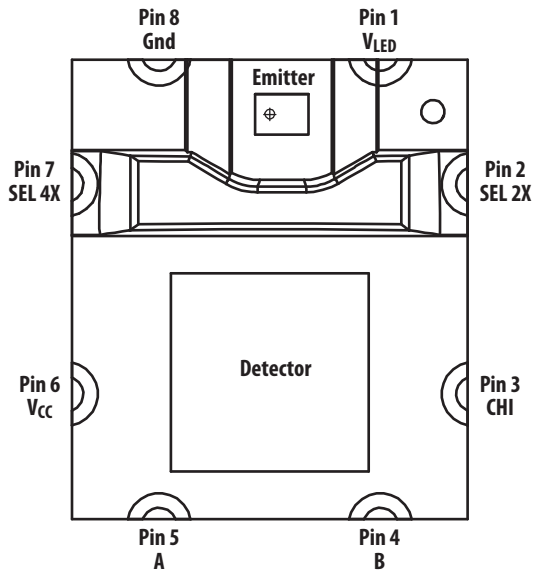

Pin configuration (Top view)

Encoder's Built-in Interpolation

Pin (Interpolation)		Interpolation Factor	CPR @ (R _{OP} = 11.38 mm)	Count Frequency
SEL 4X	SEL 2X			
L	L	1X	828	55 KHz
L	H	2X	1656	110 KHz
H	L	4X	3312	220 KHz
H	H	Factory use		

H = HIGH Logic Level L = LOW Logic Level

The interpolation factor above may be used in conjunction with the below formulae to cater the needs for various rotation speed (RPM) and count.

$$\text{RPM} = (\text{Count Frequency} \times 60) / \text{CPR}$$

The CPR (@ 1X interpolation) is based on the following formulae which is directly dependent on R_{OP}

$$\text{CPR} = \text{LPI} \times 2\pi \times \text{R}_{\text{OP}} \text{ (inch) or}$$

$$\text{CPR} = \text{LPmm} \times 2\pi \times \text{R}_{\text{OP}} \text{ (mm)}$$

Encoding Characteristics (Codewheel of Rop @11.38 mm)

Encoding characteristics over the recommended operating condition and mounting conditions.

Parameter	Symbol	Typical			Unit
		1 X	2 X	4 X	
Interpolation factor		1 X	2 X	4 X	
Cycle Error	ΔC	18	22	36	$^{\circ}e$
Pulse Width Error	ΔP	15	20	30	$^{\circ}e$
Phase Error	$\Delta\phi$	9	15	18	$^{\circ}e$
State Error	ΔS	10	15	25	$^{\circ}e$
Index Pulse Width (Gated 90°)	P_O	90	90	90	$^{\circ}e$
Index Pulse Width (Gated 180°)	P_O	180	180	180	$^{\circ}e$
Index Pulse Width (Gated 360°)	P_O	Not Available	360	360	$^{\circ}e$

Notes:

1. Typical values represent the encoder performance at typical mounting alignment, whereas the maximum values represent the encoder performance across the range of recommended mounting tolerance.
2. For optimal performance, please refer to alignment method as described in Application Note 5500 (document AV02-2789EN)

Electrical Characteristics

Characteristics over recommended operating conditions at 25° C.

Parameter	Symbol	Min.	Typ.	Max.	Unit	Notes
High Level Output Voltage	V_{OH}	2.4			V	$I_{OH} = -1.5 \text{ mA}$
Low Level Output Voltage	V_{OL}			0.4	V	$I_{OH} = +1.5 \text{ mA}$
Output current per channel, I_{out}	I_O	-	-	1.5	mA	
Rise Time	t_r		<100		ns	CL = 25pF RL = 2.7k Ω
Fall Time	t_f		<100		ns	

LED Current Limiting Resistor

A resistor to limit the current to the LED is required. The recommended value is 180 Ω ($\pm 1\%$) and the resistor should be placed in series between the 5 V supply and pin VLED of the encoder. This will result in an LED current of approximately 15 mA for optimal encoder performance.

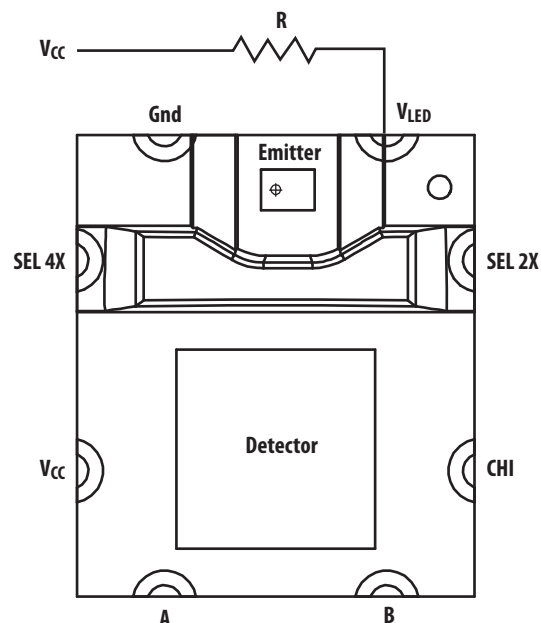

Codewheel Characteristics

The most important dimension to remember is that the index (I) channel pattern on the codewheel, the width angle is made up of $3 \times W_B^\circ$ (opaque-non reflective region).

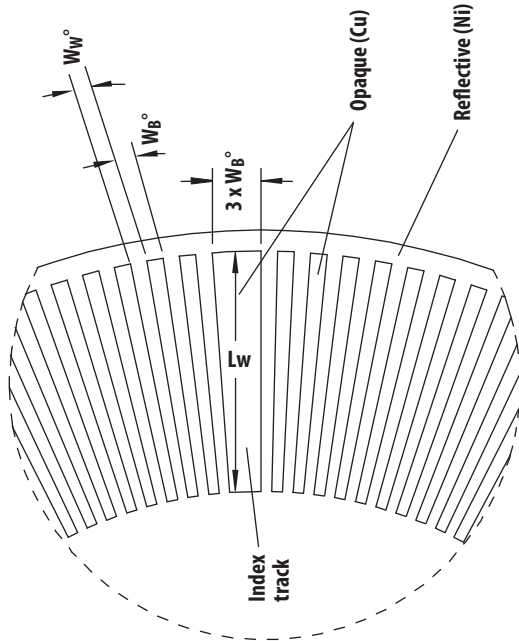

$L_w = 1.8 \text{ mm (minimum)}$

Caution: As the Index track is generated by utilizing the $3 \times W_b$ (opaque – non reflective) region, any dirt that blocked the tracks resulting in the encoder's detector sensing a $3 \times W_b$ will result in another erroneous Index.

Index track width angle is made up of $3 \times W_B^\circ$

Codewheel Design Example

The following example demonstrates a codewheel design for a Rop of 11.38 mm @ 828 CPR for a typical 2 channels encoder. In the case for an index track design, special index tracks have to be utilized.

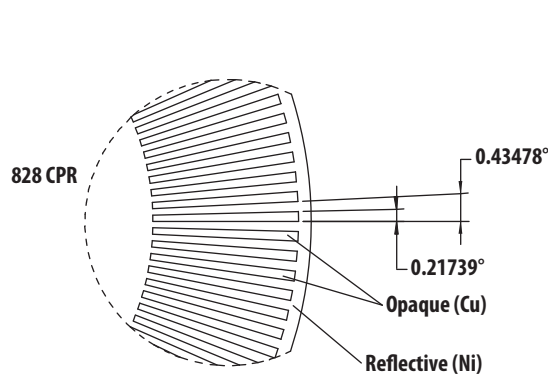

Codewheel pattern for a 2 channels encoder

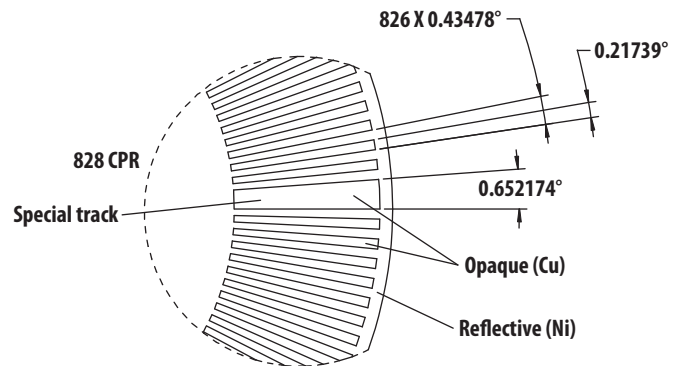

Codewheel pattern for a 3 channels encoder

Notes:

- a). 2 tracks from the original 828 CPR, 2 channels codewheel design have been utilized for the special track(Index), but CPR remains the same.

Recommended Codewheel Characteristics

Parameter	Symbol	Min.	Max.	Unit	Notes
Window/bar Ratio	Ww/Wb	0.9	1.1		
Window/bar Length	L _w	1.80 (0.071)	-	mm (inches)	
Specular Reflectance	R _f	60	-		Reflective area. See note 1.
		-	10		Non reflective area
Line Density	LPmm	11.575	11.969	lines/mm	
	LPI	294	304	lines/inch	Recommended LPI is 294

Notes:

1. Measurements from TMA μScan meter.
2. $LP_{mm} = CPR / [2\pi \cdot Rop(mm)]$
3. The LED used in AEDR-850x has a typical peak wavelength of 630nm.

Outline Drawing

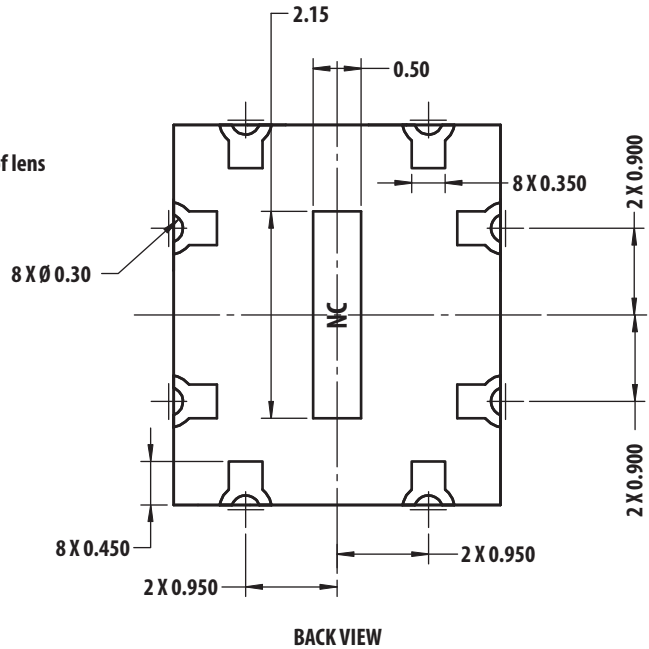
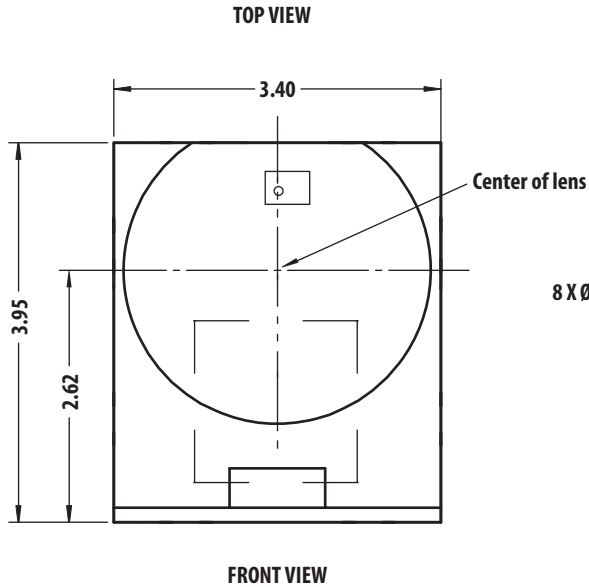
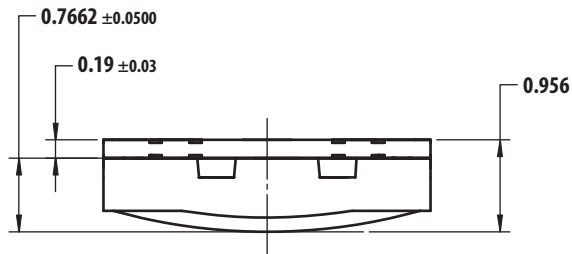

* All dimensions in millimeter.
Tolerance $x.xx \pm 0.15$ mm

Encoder Placement Orientation and Positioning

The AEDR-850X is designed such that both the emitter and detector IC should be placed parallel to the window/bar orientation, as shown (*with the encoder mounted on top of the codewheel*). See view below).

Most importantly, **the center of the lens** of the encoder unit; needs to be in line with the operating radius of the codewheel (R_{OP}) or rather the center point of Lw (0.5 of the Length of Window). Lw is recommended to be 1.8 mm or greater.

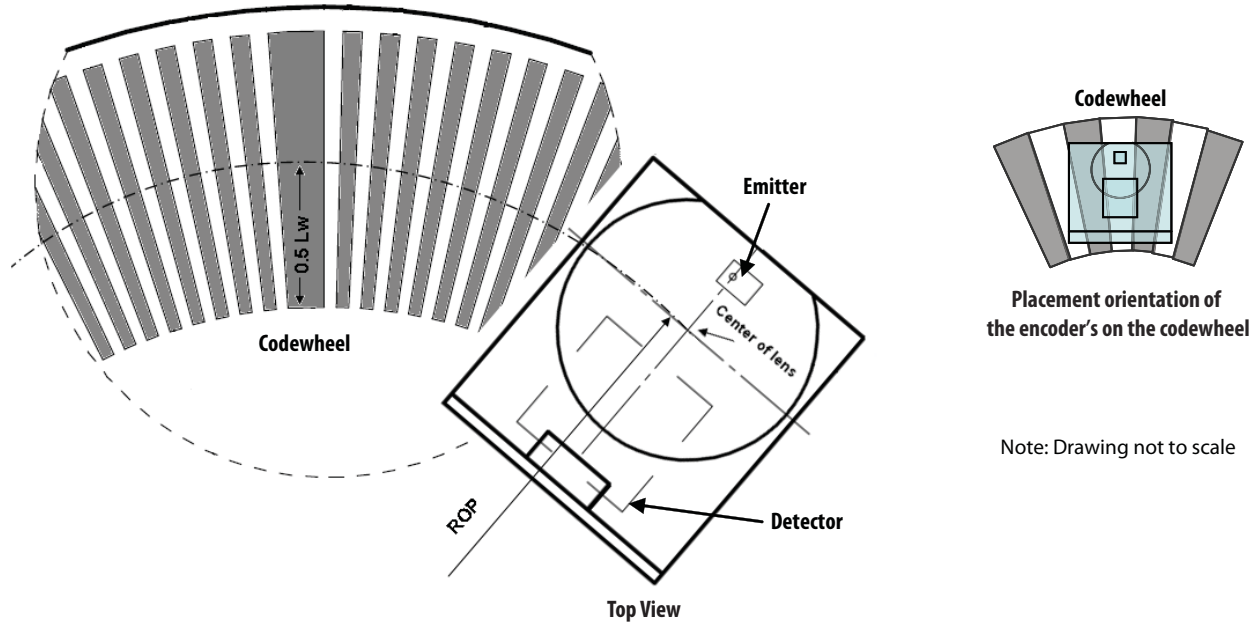

Direction of Movement

With the **detector side of the encoder placed closer to the codewheel centre**, see the above top view; Channel A leads Channel B when the codewheel rotates anti-clockwise and vice versa (*with the encoder mounted on top of the codewheel*).

The optimal gap setting recommended is between 0.5 to 1.25 mm (See side view below).

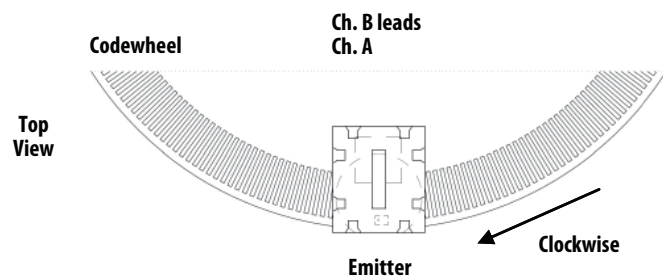
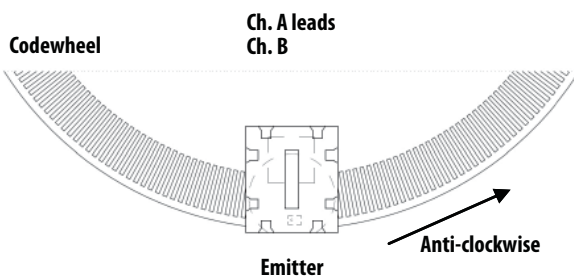
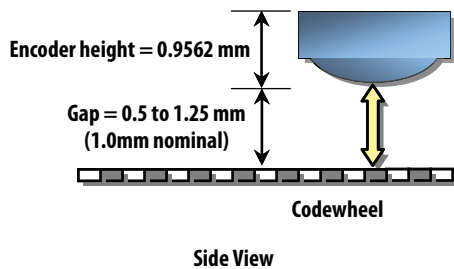

Note: Drawing not to scale.

Moisture Sensitivity Level

The AEDR-850X is specified to moisture sensitive level (MSL) 3. Precaution is required to handle this moisture sensitive product to ensure the reliability of the product.

Storage before use

- Un-open moisture barrier bag (MBB) can be stored at $<40^{\circ}\text{C}/90\%\text{RH}$ for 12 months.
- It is not recommended to open the MBB prior to assembly.

Control after open the MBB

- Encoder that will be subjected to reflow solder must mounted within 168hrs of factory condition $<30^{\circ}\text{C}/60\%\text{RH}$

Control for unfinished reel

- Stored and sealed MBB with desiccant or desiccators at $<5\%\text{RH}$.

Baking is required if :

- Humidity indicator card (HIC) is $>10\%$ when read at $23\pm 5^{\circ}\text{C}$
- The encoder floor life exceeded 168 hours.
- Recommended baking condition : $60\pm 5^{\circ}\text{C}$ for 20 hours (tape and reel)
 $125\pm 5^{\circ}\text{C}$ for 5 hours (loose unit)

Recommended Land Pattern for AEDR-850X

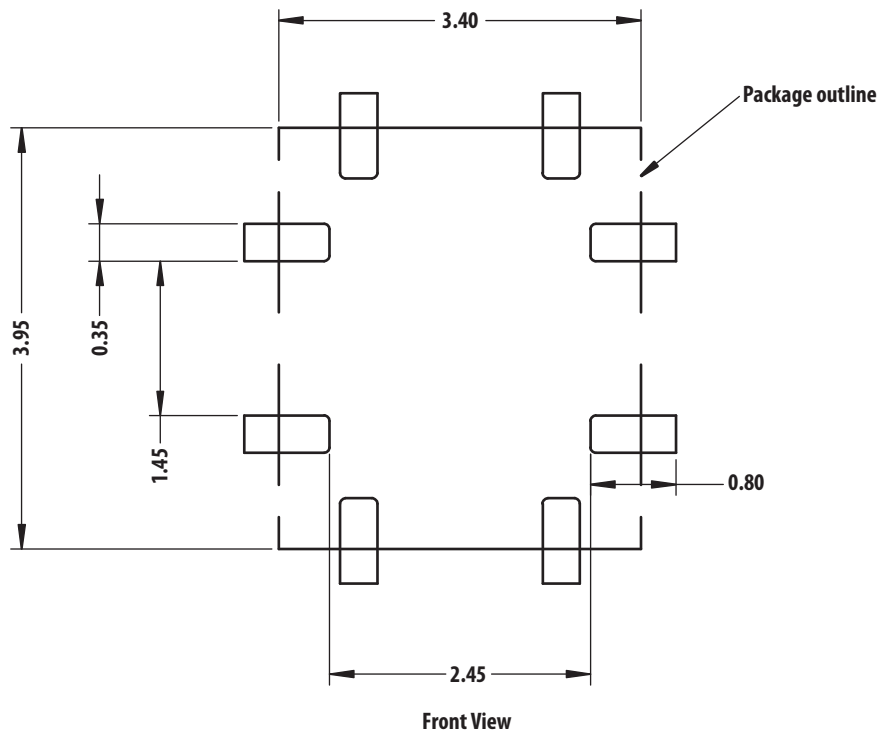

Recommended Lead-free Reflow Soldering Temperature Profile

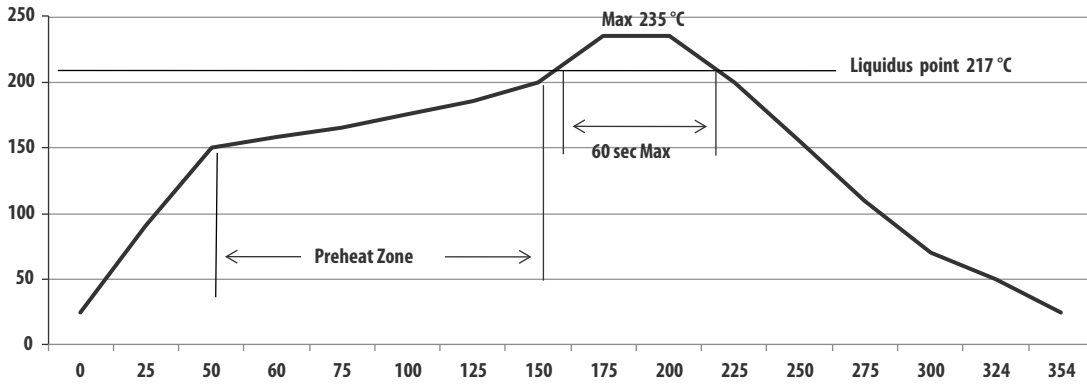

Average ramp up rate	= 3°C/sec
Average ramp down rate	= 6°C/sec
Preheat temperature	= 150° C to 200° C
Preheat time	= 60 to 100 sec
Time maintain above 217° C	= 40 to 60 sec
Peak Temperature	= 235° C
Time within 5° C of peak temperature	= 20 to 30 sec

Note:

1. Reflow with peak temperature > 235° C may cause damage to the component.
2. Due to treatment of high temperature, this clear compound may turn yellow after IR reflow.
3. Profile shown here is the actual readings from the thermocouple (attached to AEDR-850x as shown to the right) on the reflow board PCB.

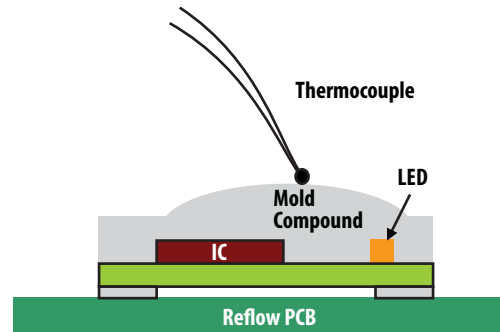

Tape and reel information

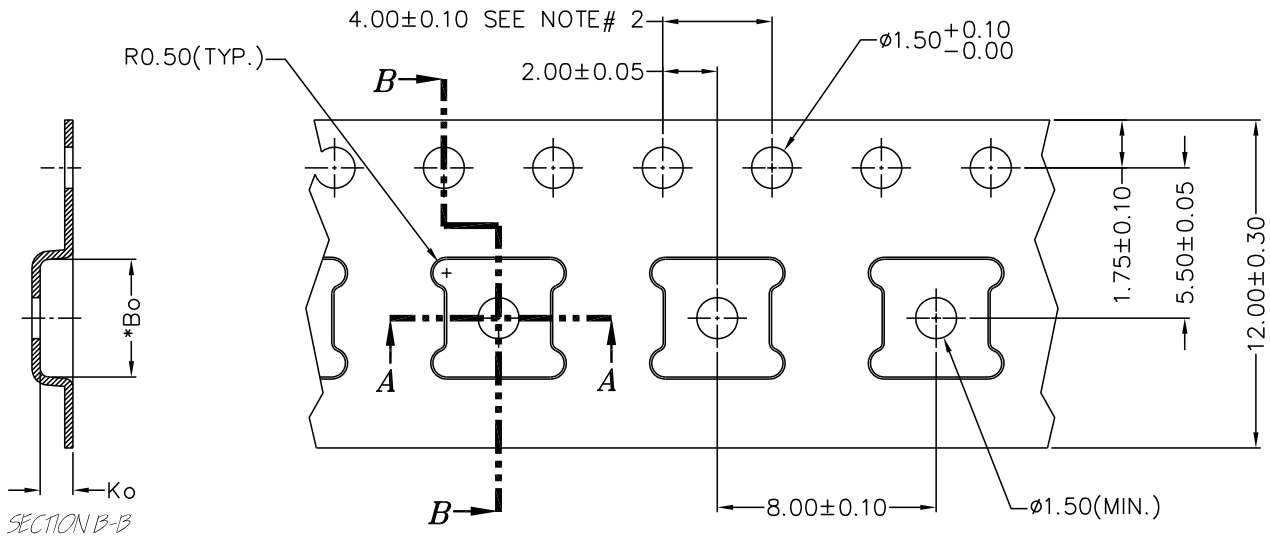

NOTES: =

1. * Ao & Bo measured at 0.3mm above base of pocket.
2. 10 pitches cumulative tol. ±0.2mm.
3. () Reference dimensions only.

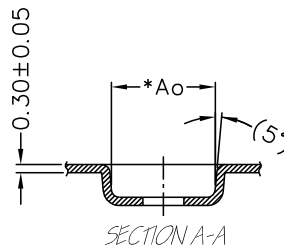

Ao:	3.80
Bo:	4.30
Ko:	1.20
Pitch:	8.00
Width:	12.00

Ordering Information

AEDR – 850x – x 0 x

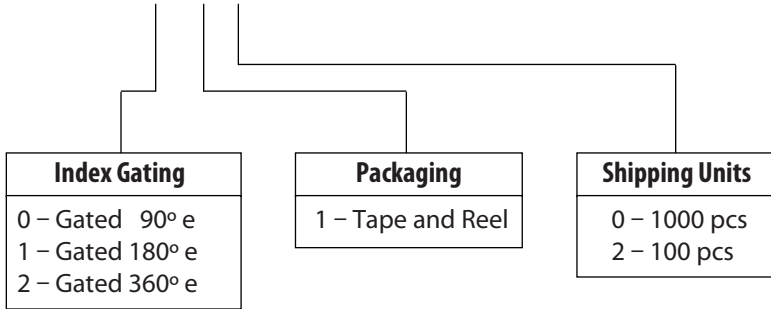

Note: Avago Technologies encoders are not recommended for use in safety critical applications, e.g., ABS braking systems, power steering, life support systems and critical care medical equipment. Avago's products and software are not specifically designed, manufactured or authorized for sale as parts, components or assemblies for the planning, construction, maintenance or direct operation of a nuclear facility or for use in medical devices or applications. Customers are solely responsible, and waive all rights to make claims against Avago or its suppliers, for all losses, damage, expense or liability in connection with such use. Please contact your local sales representative if more clarification is needed.

For product information and a complete list of distributors, please go to our web site: www.avagotech.com

Avago, Avago Technologies, and the A logo are trademarks of Avago Technologies in the United States and other countries. Data subject to change. Copyright © 2005-2012 Avago Technologies. All rights reserved.
AV02-2790EN - June 27, 2012

AVAGO
TECHNOLOGIES