



G128-0001



# ULTRA SLIMPAK® G128-0001

## DC Powered T/C Input Limit Alarm

Provides Relay Contact Closures  
at a Preset Temperature Input Level



- Programmable HI or LO, Failsafe or Non-failsafe
- Field Configurable Input Ranges
- LED Trip and Input Indicators

- Flexible Power Supply Accepts 9 to 30 VDC
- ASiC Technology for Enhanced Reliability
- RoHS Compliant

### Description

The Ultra Slim Pak G128 is a DIN rail mount, thermocouple input limit alarm with input terminal cold junction compensation (cjc), dual setpoints and two contact closure outputs. The field configurable input and alarm functions offer flexible setpoint capability. There are up to six temperature ranges available for each thermocouple type to ensure accuracy and maximize setpoint resolution.

The G128 is configurable as a single or dual setpoint alarm, with HI or LO trips, upscale or downscale thermocouple burnout detection and failsafe or non-failsafe operation. Also included are adjustable deadbands (0.25 to 5% of full scale input) for each setpoint and a flexible DC power supply which accepts any voltage between 9 and 30VDC.

### Diagnostic LEDs

The G128 is equipped with three front panel LEDs. The dual function green LED is labeled INPUT and indicates line power and input signal status. Active DC power is indicated by an illuminated LED. If this LED is off, check DC power and the wiring connection. If the input signal is more than 110% of the full scale range, the LED will flash at 8 Hz. Below -10%, it flashes at 4 Hz. Two red LEDs indicate the relay state for each setpoint. An illuminated red LED indicates the tripped condition.

### Output

The G128 is equipped with two SPDT (form C) relays, rated at 120VAC or 28VDC at 5 Amperes. Each of these relays is independently controlled by the field configurable setpoint and deadband.

### Operation

The field configurable G128 limit alarm setpoints can be configured for HI or LO, failsafe or non-failsafe operation. Each of the setpoints has a respective HI or LO deadband. In a tripped condition, the setpoint is exceeded and the appropriate red LED will illuminate. The trip will reset only when the process falls below the HI deadband or rises above the LO deadband (see Figure 1). For proper deadband operation, the HI setpoint must always be set above the LO setpoint. In failsafe operation, the relay is energized when the process is below the HI setpoint or above the LO setpoint (opposite for non-failsafe). In the failsafe mode, a power failure results in an alarm state output.

### Dynamic Deadband

Circuitry in the G128 prevents false trips by repeatedly sampling the input. The input must remain beyond the setpoint for 100 milliseconds, uninterrupted, to qualify as a valid trip condition. Likewise, the input must fall outside the deadband and remain there for 100 milliseconds to return the alarm to an untripped condition. This results in a "dynamic deadband" (based on time) in addition to the normal deadband.

### Configuration

Unless otherwise specified, the factory presets the Model G128 as follows:

Input: J Type  
Range: 0 to 350°C  
Output: Dual, SPDT  
Trip: A: HI, B: LO  
Failsafe: No  
Deadband: A, B: 0.25%

The DC power input accepts any DC source between 9 and 30V; typically a 12V or 24VDC source is used (see Accessories).

For other I/O ranges, refer to Table 1 and reconfigure switches SW1 and SW2 for the desired input type, range and function.

**WARNING:** Do not change switch settings with power applied. Severe damage will result!

1. With DC power off, set SW1-1, 2, 3 and SW2-1 through 6 for the desired input range (Table 1).
2. Set positions 4 and 5 of "SW1" to ON for a HI trip setpoint or OFF for a LO trip setpoint (Figure 4).
3. Set position 6 of "SW1" to ON for non-failsafe operation or OFF for failsafe operation (e.g., alarm trips upon power failure).
4. Set positions 7 and 8 of "SW1" to upscale or downscale burnout.

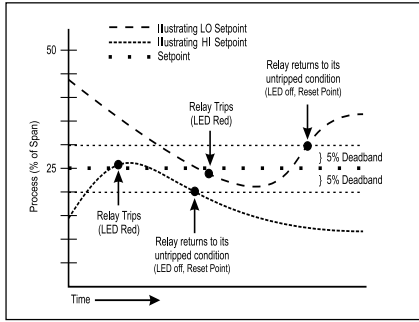

Figure 1: Limit alarm operation and effect of deadband.

**Calibration**

1. After configuring the DIP switches, connect the input to a calibrated TC source and apply power. Refer to the terminal wiring (Figure 5).

*Note: To maximize thermal stability, final calibration should be performed in the operating installation, allowing approximately 1 to 2 hours for warm up and thermal equilibrium of the system.*

2. Setpoint: set deadband at its minimum (fully counterclockwise) before adjusting the setpoint. With the desired trip thermocouple millivolt input applied, adjust the setpoint until the relay trips. For HI trip calibration, start with the setpoint above the desired trip (fully clockwise). For LO trip calibration, start below the desired trip (fully counterclockwise).

3. Deadband: Set deadband to its minimum (fully counterclockwise). Set the setpoint to the desired trip. Adjust the thermocouple millivolt input until the relay trips. Readjust deadband to 5% (fully clockwise). Set the input to the desired deadband position. Slowly adjust deadband until the relay untrips

**Relay Protection & EMI Suppression**

When switching inductive loads, maximum relay life and transient EMI suppression is achieved using external protection (see Figures 2 and 3). Place all protection devices directly across the load and minimize all lead lengths. For AC inductive loads, place a properly rated MOV across the load in parallel with a series RC snubber. Use a 0.01 to 0.1uF pulse film capacitor (foil polypropylene recommended) of sufficient voltage, and a 47 ohm, 1/2W carbon resistor. For DC inductive loads, place a diode across the load (PRV > DC supply, 1N4006 recommended) with (+) to cathode and (-) to anode (the RC snubber is an optional enhancement).

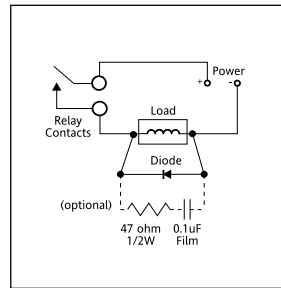

Figure 2: DC Inductive Loads

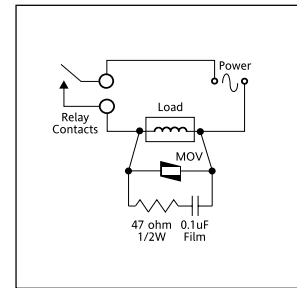

Figure 3: AC Inductive Loads

Table 1: G128 Input Range Settings

TC	Input Range	SW1		Selector SW2						
		1	2	3	1	2	3	4	5	6
B	0 to 1490 <sub>i</sub> C (32 to 2714 <sub>i</sub> F)	■	■							■
B	0 to 1820 <sub>i</sub> C (32 to 3308 <sub>i</sub> F)	■	■	■						■
E	0 to 150 <sub>i</sub> C (32 to 302 <sub>i</sub> F)	■								■
E	0 to 290 <sub>i</sub> C (32 to 554 <sub>i</sub> F)	■								■
E	0 to 660 <sub>i</sub> C (32 to 1220 <sub>i</sub> F)	■								■
E	0 to 1000 <sub>i</sub> C (32 to 1832 <sub>i</sub> F)	■								■
E	-270 to 150 <sub>i</sub> C (-454 to 302 <sub>i</sub> F)	■								■
E	-270 to 290 <sub>i</sub> C (-454 to 554 <sub>i</sub> F)	■	■	■						■
J	0 to 190 <sub>i</sub> C (32 to 374 <sub>i</sub> F)	■								■
J	0 to 350 <sub>i</sub> C (32 to 662 <sub>i</sub> F)	■	■	■						■
J	0 to 760 <sub>i</sub> C (32 to 1400 <sub>i</sub> F)	■								■
J	-210 to 190 <sub>i</sub> C (-364 to 374 <sub>i</sub> F)	■								■
J	-210 to 350 <sub>i</sub> C (-364 to 662 <sub>i</sub> F)	■	■	■						■
K	0 to 250 <sub>i</sub> C (32 to 482 <sub>i</sub> F)	■								■
K	0 to 480 <sub>i</sub> C (32 to 896 <sub>i</sub> F)	■	■							■
K	0 to 1280 <sub>i</sub> C (32 to 2336 <sub>i</sub> F)	■								■
K	0 to 1372 <sub>i</sub> C (32 to 2502 <sub>i</sub> F)	■	■	■						■
K	-270 to 250 <sub>i</sub> C (-454 to 482 <sub>i</sub> F)	■								■
K	-270 to 480 <sub>i</sub> C (-454 to 896 <sub>i</sub> F)	■	■	■						■
R	0 to 970 <sub>i</sub> C (32 to 1778 <sub>i</sub> F)	■								■
R	0 to 1690 <sub>i</sub> C (32 to 3000 <sub>i</sub> F)	■	■	■						■
R	0 to 1760 <sub>i</sub> C (32 to 3200 <sub>i</sub> F)	■								■
S	0 to 1050 <sub>i</sub> C (32 to 1922 <sub>i</sub> F)	■								■
S	0 to 1750 <sub>i</sub> C (32 to 3182 <sub>i</sub> F)	■	■	■						■
T	0 to 210 <sub>i</sub> C (32 to 410 <sub>i</sub> F)	■								■
T	0 to 390 <sub>i</sub> C (32 to 734 <sub>i</sub> F)	■	■	■						■
T	-270 to 210 <sub>i</sub> C (-454 to 410 <sub>i</sub> F)	■								■
T	-270 to 390 <sub>i</sub> C (-454 to 734 <sub>i</sub> F)	■	■	■						■

Key: ■ = 1 = ON or Closed

Table 2: G128 Trip Settings

Function	Selector SW1				
	4	5	6	7	8
Trip B HI	■				
Trip A HI		■			
Non-Failsafe			■		
Burnout Up				■	
Burnout Down					■

Key: ■ = 1 = ON or Closed

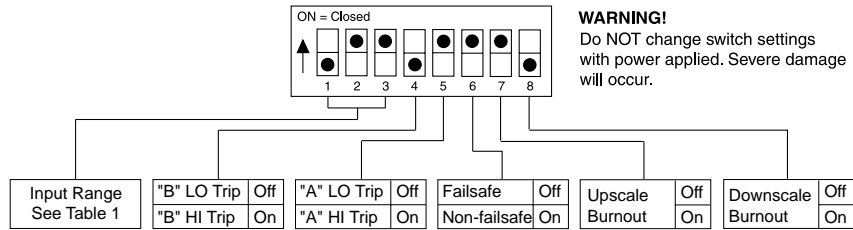

Figure 4: Input Range/Function Selection (SW1) Factory Default Settings

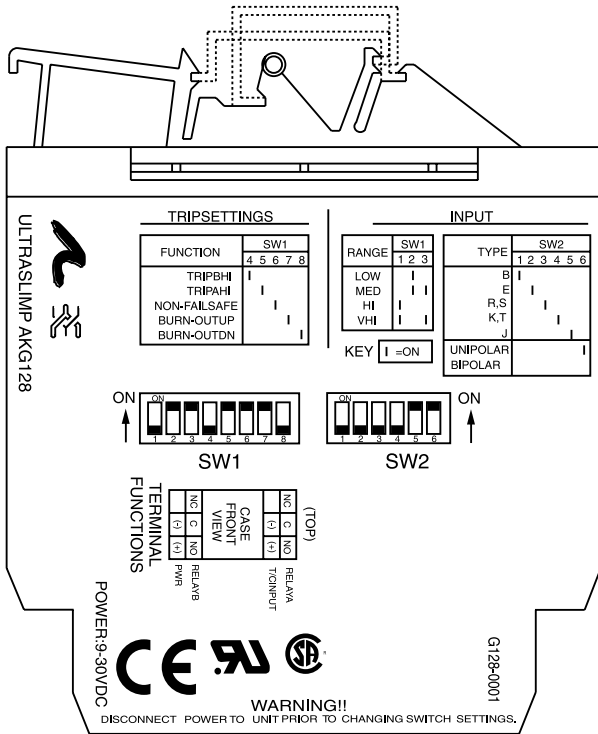

Figure 5: G128 Factory Cal: J-Type, 0 to 350°C, A-HI/B-LO, Non-failsafe

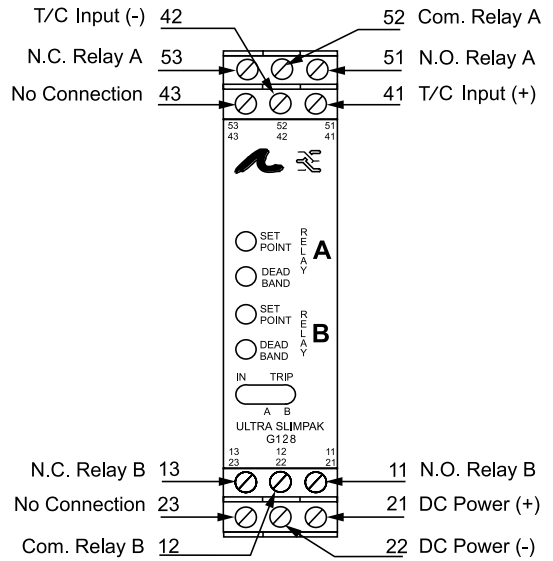

Figure 6: Wiring Diagram for G128

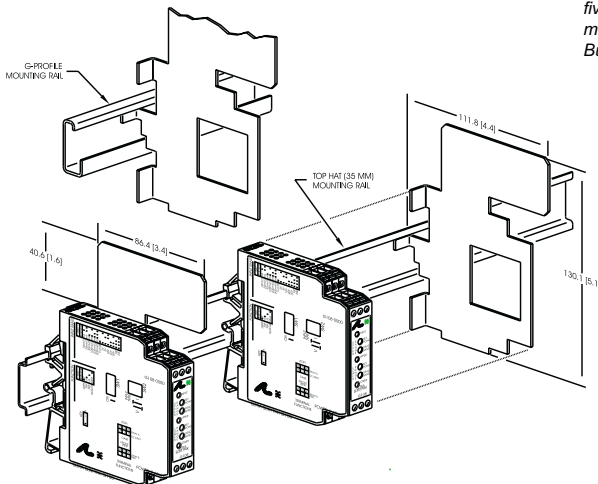

Figure 7: Mounting Multiple Modules

Note: All Ultra SlimPak modules are designed to operate in ambient temperatures from 0 to 55°C when mounted on a horizontal DIN rail. If five or more modules are mounted on a vertical rail, circulating air or model HS01 Heat Sink is recommended. Refer to HS01 Technical Bulletin (#721-0549-00) or contact the factory for assistance.

## Specifications

### Inputs

Range: See Table 1  
Impedance: >1M Ohm  
Input Bias Current (burnout detect): <1.5 uAmp  
Overvoltage: ±10V differential  
Common Mode (Input to Gnd): 1800VDC, max.

### LED Indicators

Input Range (Green)  
>110% input: 8Hz flash  
<-10% input: 4Hz flash  
Setpoint (Red):  
Tripped: Solid red  
Safe: off

### Limit Differentials (Deadbands)

0.25% to 5% of span

### Response Time

Dynamic Deadband:  
Relay status will change when proper setpoint/process condition exists for 100msec  
Normal Mode (analog filtering):  
<250msec, (10-90%)

### Setpoint

Effectivity:  
Setpoints are adjustable over 100% of the selected input span  
Repeatability (constant temp.):  
0.2% for temp > 0°C  
0.3% for temp < 0°C

### Stability

Temperature: ±0.05% of full scale/°C, max.

### Common Mode Rejection

DC to 60Hz: 120dB

### Isolation

1800VDC between contacts, input & power

### EMC Compliance (CE Mark)

Emissions: EN50081-1  
Immunity: EN50082-2  
Safety: EN50178

### Humidity (Non-Condensing)

Operating: 15 to 95% @45°C  
Soak: 90% for 24 hours @65°C

### Temperature Range

Operating: 0 to 55°C (32 to 131°F)  
Storage: -15 to 70°C (5 to 158°F)

### Power

Consumption: 1.5W typical, 2.5W max.  
Supply Range: 9 to 30 VDC, inverter isolated

### Relay Contacts

2 SPDT (2 Form C) Relays, 1 Relay per setpoint  
Current Rating (resistive)  
120VAC: 5A; 240VAC: 2A; 28VDC: 5A  
Material: Gold flash over silver alloy  
Electrical Life: 10<sup>5</sup> operations at rated load  
*Note: External relay contact protection is required for use with inductive loads (see relay protection Figures 2 & 3).*  
Mechanical Life: 10<sup>7</sup> operations

### Wire Terminations

Screw terminations for 12-22 AWG

### Weight

0.56lbs.

### Agency Approvals

UL recognized per standard UL508 (File No.E99775)  
CE Compliance per EMC directive 89/336/EEC and low voltage 73/23/EEC.  
RoHS Compliant

## Ordering Information

### Models & Accessories

#### Specify:

1. Model: **G128-0001**
2. Accessories: (see Accessories)
3. Optional Custom Factory Calibration; specify **C620** with desired input and output range.

### Accessories

SlimPak "G" series modules will mount on standard TS32 (model MD02) or TS35 (model MD03) DIN rail. In addition, the following accessories are available:

- HS01** Heat Sink
- MD03** TS35 x 7.5 DIN Rail
- WV905** 24VDC Power Supply (0.5A)
- H910** 24VDC Power Supply (1A)
- H915** 24VDC Power Supply (2.3A)
- MB03** End Bracket for MD03
- C664** I/O Descriptive Tags

## Dimensions

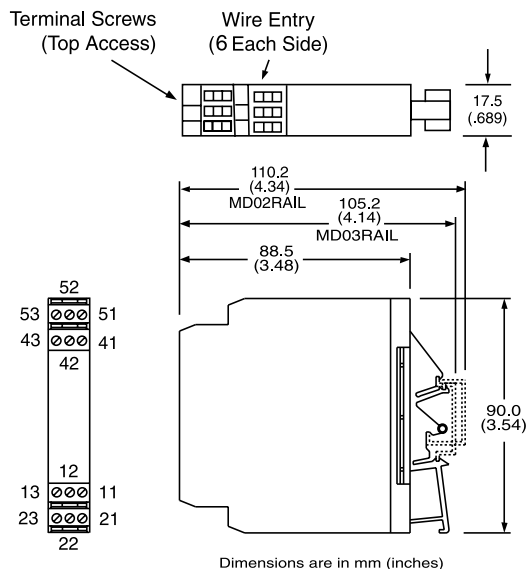

## Factory Assistance

For additional information on calibration, operation and installation contact our Technical Services Group:

**703-669-1318**

[actionsupport@eurotherm.com](mailto:actionsupport@eurotherm.com)

721-0654-00-G 02/09 Copyright© Eurotherm, Inc 2009

## Eurotherm, Inc

741-F Miller Drive  
Leesburg, VA 20175-8993  
703-443-0000

[info@eurotherm.com](mailto:info@eurotherm.com) or [www.eurotherm.com/actionio](http://www.eurotherm.com/actionio)