

THIS IS A C.A.D. GENERATED DRAWING
DO NOT MAKE MANUAL REVISIONS TO MASTER.

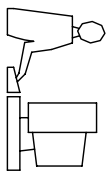

* UNLESS OTHERWISE SPECIFIED TOLERANCES
ON DECIMAL IS: ANGLE ± 1°
UNIT: MM .XX ± 0.35

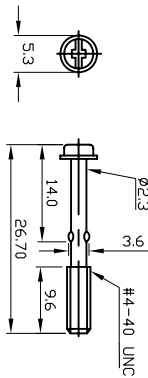
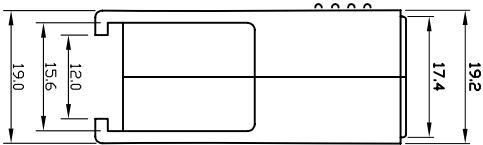
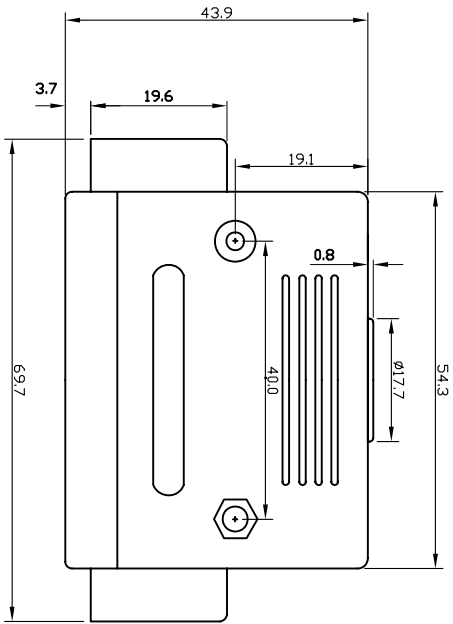
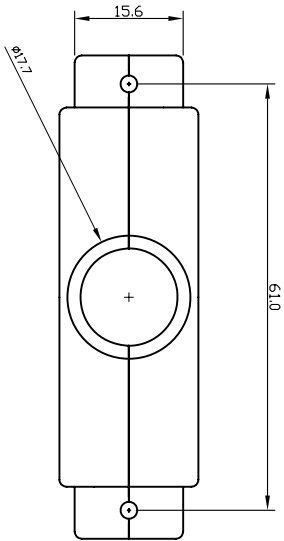

MATERIAL:
INSULATOR : ABS UL94HB
SCREW : STEEL
FINISHED : CHROMATE PLATED
R=ROHS
SHORT SCREW
INSULATOR COLOR
C=METALIZED

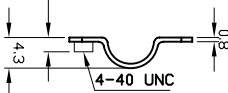
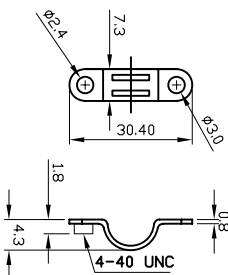
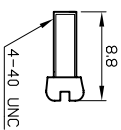
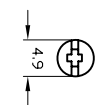
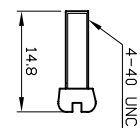
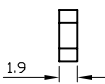
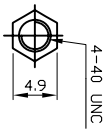

THESE DRAWINGS AND SPECIFICATIONS ARE THE PROPERTY OF MH CONNECTORS LTD. AND SHALL NOT BE REPRODUCED, COPIED OR USED AS THE BASIS FOR THE MANUFACTURE OR SALE OF APPARATUS WITHOUT WRITTEN PERMISSION.

DRAWN	DATE
Johnny	09-24-12
APPROVED	DATE

SCALE	SHEET	OF	REV:
	1	OF 1	1.0



THIS SERIES FULLY CONFORMS TO THE
EUROPEAN UNION DIRECTIVES 2002/95/EC
AND 2002/96/EC FOR ROHS COMPLIANCY.



D-SUB PLASTIC HOOD , U-TYPE
50P LONG EAR, SHORT SCREW

DRAWING No	MHCCTV50-SC-MP
------------	----------------