



Safety relays PNOZsigma

Application examples for project configuration –
safety relays PNOZsigma

pilz

Why does Pilz offer more?



Because the integrality of our business activities is what sets us apart.



Pilz is a solution supplier for all automation functions. Including standard control functions. Developments from Pilz protect man, machine and the environment. That's why all our experience and knowledge goes into individual products as well as consistently sophisticated system solutions.

- ▶ Sensor technology
- ▶ Control technology
- ▶ Networks
- ▶ Drive technology
- ▶ Operator and visualisation systems
- ▶ Software
- ▶ Consulting and engineering
- ▶ Training

Appropriate services relating to individual components and independent generic services guarantee that our customers obtain customised automation solutions, all from one source.

You can find more details about Pilz and your products and services on the Internet:

- ▶ www.pilz.com

Pilz is a family business that's closer to its customers

Pilz has a tradition as a family-run company stretching back 60 years. Real proximity to customers is visible in all areas, instilling confidence through individual consultation, flexibility and reliable service.

We are your contact, guide and competency leader en route to an optimum automation solution.

Support – Technical help round the clock!

Technical support is available from Pilz round the clock. This service is provided free of charge beyond standard business hours.

You can reach our international hotline on:

- ▶ +49 711 3409-444

Exclusion of liability

Our application manual has been compiled with great care. It contains information about our company and our products. All statements are made in accordance with the current status of technology and to the best of our know-ledge and belief. However, we cannot except liability for the accuracy and entirety of the information provided, except in the case of gross negligence. In particular it should be noted that statements do not have the legal quality of assurances or assured properties. We are grateful for any feedback on the contents.

October 2011

All rights to this publication are reserved by Pilz GmbH & Co. KG. We reserve the right to amend specifications without prior notice. Copies may be made for the user's internal purposes. The names of products, goods and technologies used in this manual are trademarks of the respective companies.

Solution supplier for safety and standard

Pilz offers a universal concept for solutions that can be applied right across industry. Whether you need safety or standard control functions, machine or plant, centralised or decentralised, a single product or a total solution: With Pilz you will definitely find a solution for your automation function.

Are you looking for a flexible solution for your automation functions?

- ▶ **PMD:** Electronic monitoring relays such as voltage or true power monitors, for example.
- ▶ **PNOZ:** Safety relays for simple plant and machinery with up to 4 safety functions. Safe monitoring of E-STOPS, safety gates and light curtains/light grids, for example.
- ▶ **PNOZmulti:** The safety circuit is created using a simple configuration tool. Applicable from 4 safety functions.
- ▶ **PSS:** Programmable control systems for use on complex machinery or distributed plants, to monitor safety-related functions and/or for complete machine control.
- ▶ **Industrial communication:** Transfer input/output signals and control data reliably and safely.

Your requirements:	Our solution:	Supplementary product ranges:
	<p><i>PMD electronic monitoring relays</i></p>	<p><i>Sensor technology</i></p>
	<p><i>PNOZ safety relays</i></p>	<p><i>Drive technology</i></p>
	<p><i>PNOZmulti configurable control system</i></p>	<p><i>Operator and visualisation systems</i></p>
	<p><i>PSS programmable control systems</i></p>	<p><i>Software</i></p>
	<p><i>SafetyBUS p</i> <i>induraNET p</i></p>	<p><i>Services</i></p>
	<p><i>Industrial communication networks</i></p>	

Sensor technology, used in conjunction with Pilz safe control technology, offers a coordinated, complete solution that's economical, approved and safe. The focus is always on the protection of man and machine, in compliance with the standards and regulations.

Drive technology provides overall solutions for automating your machinery. From controller operation through to movement of highly dynamic drives, including all safety aspects.

Operator and visualisation systems provide diagnostic and visualisation devices, plus control and signal devices as part of the Pilz solution. The focus is always on fast, simple configuration. Machine downtimes are clearly reduced thanks to the overall diagnostic concept PVIS.

Software includes system software, user software and software tools. Here you'll find the right tool for every task. From product-related software to diagnostic software, through to the PAScal Safety Calculator.

Services in the field of machinery safety are covered holistically by Pilz. From risk assessment through to ESPE inspection. Pilz also offers a comprehensive range of training courses and seminars, covering generic issues relating to machinery safety as well as Pilz products.

Standards and Directives	1.0
Standards and Directives	1.1
Application Examples	2.0
Emergency Stop Applications	2.1
Safety Gate Applications	2.2
ESPE Applications	2.3
Two-hand Applications	2.4
Further Applications	2.5
Service	3.0
Pre-sales, after sales, Your partner for practical training, Business terms and conditions	3.1

Contents	Page
Standards and Directives	
European directives and position of the standards in Europe	1.1-2
Risk assessment	1.1-4
Legal regulations outside Europe and standards for functional safety	1.1-5
Safety-related parts of control systems – General principles for design in accordance with EN ISO 13849-1	1.1-6
Functional safety and legal position of EN/IEC 61508	1.1-8
Functional safety in accordance with EN/IEC 62061	1.1-9
Risk parameters and categories in accordance with EN 954-1/EN ISO 13849-1	1.1-11

European directives and position of the standards in Europe

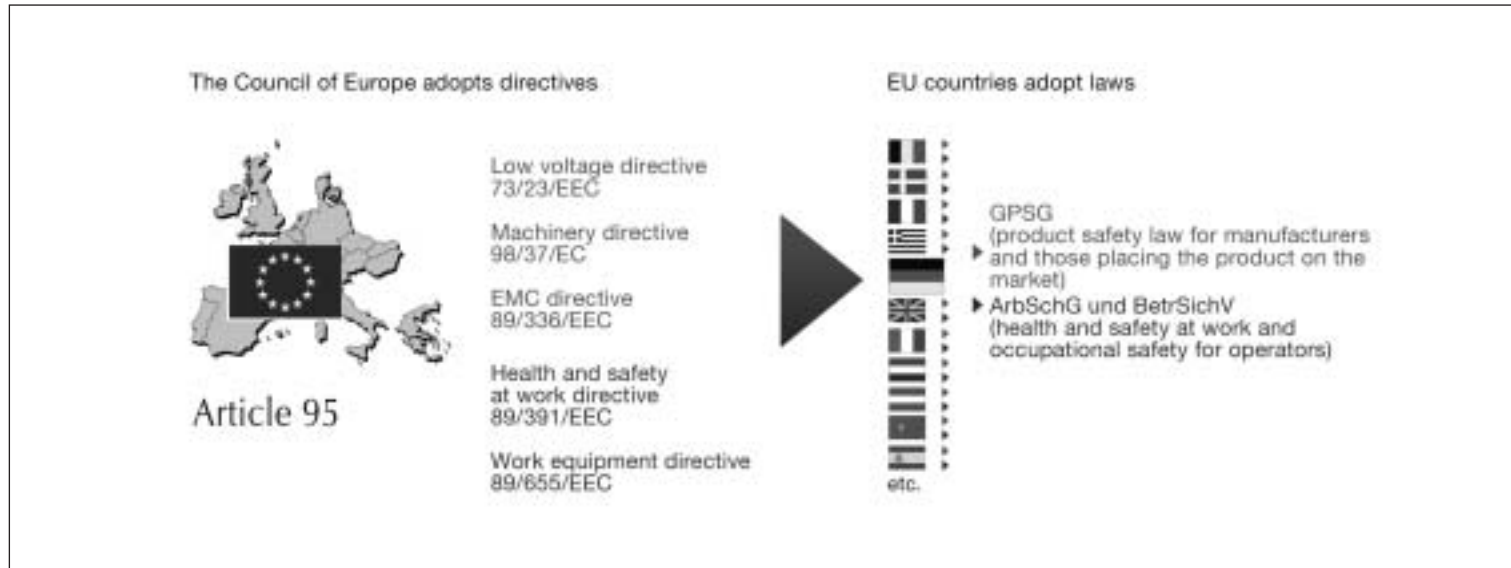

Incorporation of the directives into domestic law (using Germany as an example)

European directives

The concept of a single European internal market in terms of the “New Approach” can be traced right back to the start of the 70s: The low voltage directive is the first piece of European legislation to take into account the approach towards harmonisation of a common single market.

Products that are covered by one or more of the following directives have to apply a CE-mark, i.e. the product must be accompa-

nied by a declar-ation of conformity. With a declaration of conformity the manufacturer confirms that his product meets all the requirements of the European directives that relate to his product. This means he can launch and sell his product within the scope of the EU without consideration of any national regulations.

Key engineering directives:

- ▶ General product safety (2001/95/EC)
- ▶ Health and safety (89/391/EEC)
- ▶ Use of work equipment (89/655/EEC)
- ▶ Lifts (95/16/EC)
- ▶ Waste electrical and electronic equipment (2002/96/EC)
- ▶ Electromagnetic compatibility (EMC) (2004/108/EC)
- ▶ Devices for use in potentially explosive areas (ATEX) (94/9/EC)
- ▶ Machinery (98/37/EC) / (2006/42/EC)

- ▶ Low voltage equipment (2006/95/EC)
- ▶ Personal protective equipment (89/686/EEC)
- ▶ Cable cars (2000/9/EC)

The directives are addressed to member states, who are obliged to incorporate the European directives into domestic law. In Germany this is normally achieved through the device safety law.

European directives and position of the standards in Europe

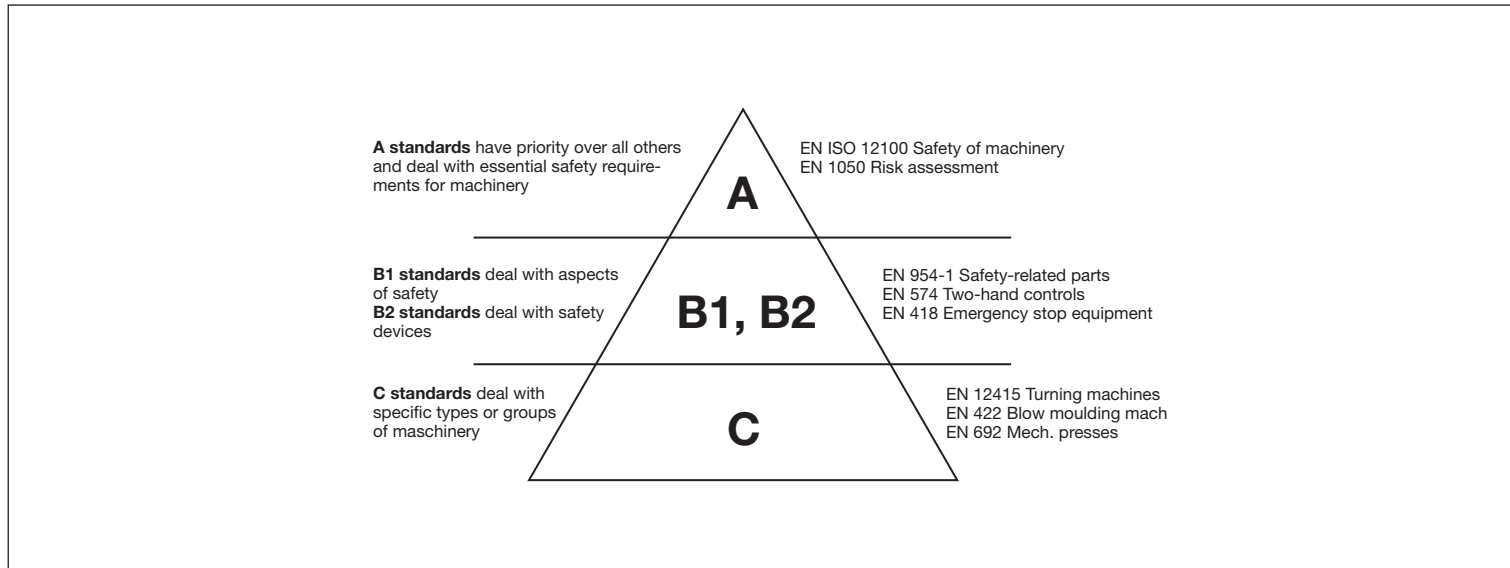

Standards pyramid

Position of the standards in Europe

The legal position of standards is discussed again and again. Inside Europe, i.e. within the scope of the European directives that are subject to the CE-marking obligation, a manufacturer is not bound by standards or other specifications. He simply needs to comply with the health and safety requirements of the directive(s). The associated benefits of a division between standards and legislation are obvious: It is easier for legislators to agree on the essential requirements than on technical details. Also, the directives

do not regularly have to be adapted to the state of technology; member states can use their own legal system for incorporation and manufacturers are free to select the ways in which they implement the requirements of the directive.

So what are the benefits of applying the standards? With so-called harmonised standards with presumption of conformity, there is a shifting of the burden of proof, i.e. if manufacturers apply these standards, it is presumed that they will also comply with the specific requirements of the European

directives. The regulatory authorities would therefore need to prove that a manufacturer did not meet the legal requirements.

However, should a manufacturer deviate from the harmonised standards, he himself must prove how he has met the essential safety requirements. This is generally done via a hazard analysis. In practice one would endeavour to apply the harmonised standards, unless the products concerned are highly innovative and no harmonised standards yet exist. The standards for which this “presumption effect” applies can be researched

in the Official Journal of the EU (e.g. on the Internet). Standards in Europe are subdivided into what are termed A, B and C standards.

Risk assessment

Risk assessment

Under the terms of the machinery directive, a machine manufacturer must assess the hazards in order to identify all the hazards that apply to his machine. He must then design and construct the machine to take account of his assessment. This requirement also applies to operators who act as manufacturers under the terms of the machinery directive. For example, this may occur with machines that are interlinked or for machinery that has been upgraded and substantially modified.

EN ISO 14121-1 contains “Principles for risk assessment” on machinery. These approaches can be called upon as part of a comprehensive analysis. EN ISO 13849-1 expands on EN ISO 14121-1 with regard to the assessment of safety-related parts of control systems.

The hazards emanating from a machine may be many and varied, so for example, it is necessary to consider not just mechanical hazards through crushing and shearing, but also thermal and electrical hazards and hazards from radiation. Risk reduction is therefore an iterative process, i.e. it is carried out before and during the planning phase and after completion of the plant or machine.

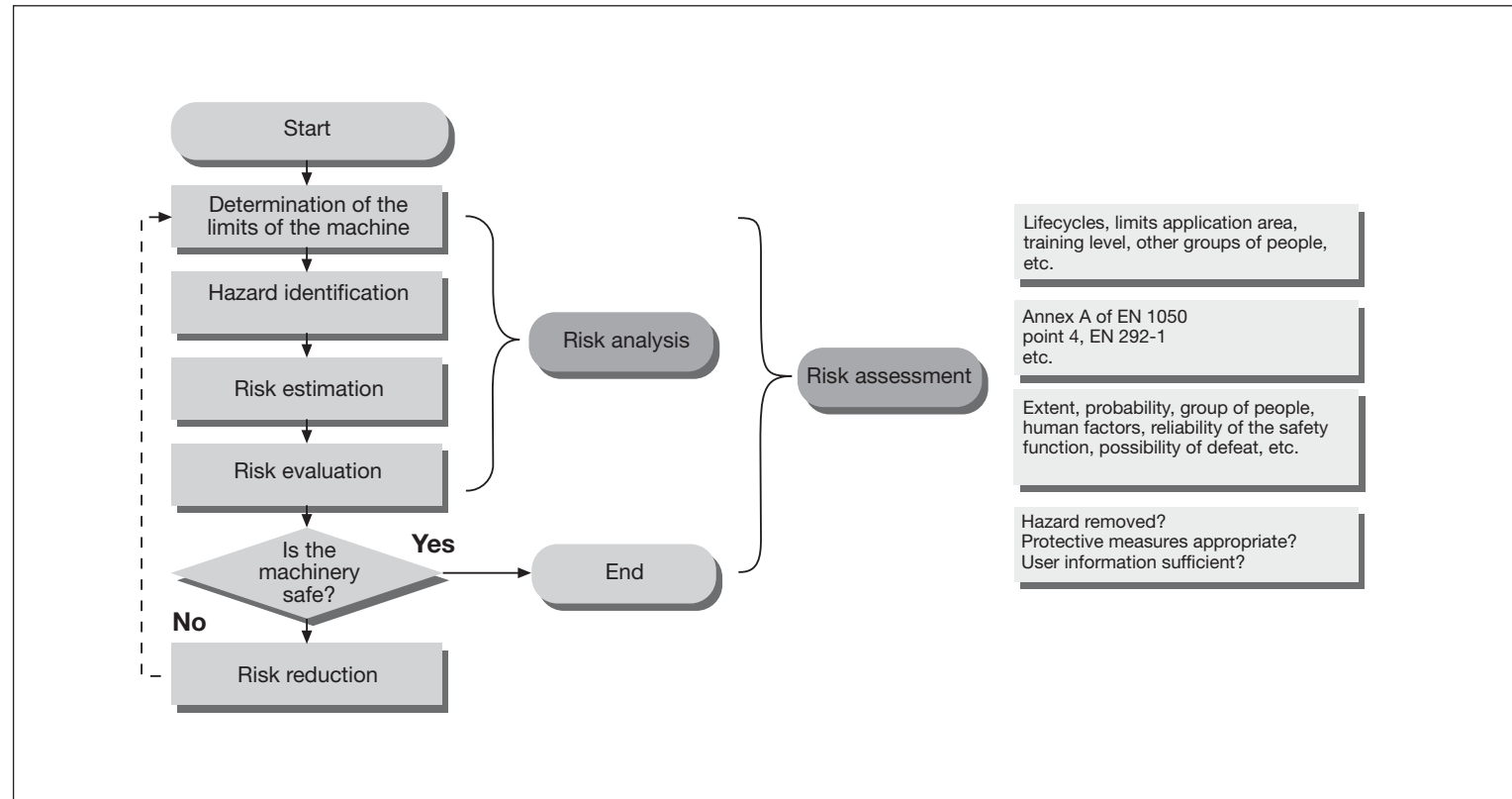

Iterative process in accordance with EN ISO 14121-1

Legal regulations outside Europe and standards for functional safety

Legal regulations outside Europe

The situation is somewhat different in the USA: people there are mainly familiar with two types of standards: ANSI (American National Standards Institute) and OSHA (Occupational Safety and Health Administration).

OSHA standards are published by the state and compliance is mandatory. ANSI standards, on the other hand, are developed by private organisations and their application is generally not absolutely essential. However, ANSI standards can still be found included as part of a contract. Beyond that ANSI standards are being taken over by OSHA. You can also still come across the NFPA (National Fire Protection Association), which developed NFPA 79 as a counterpart to EN 60204-1, for example. The OSHA standards can be compared with the European directives. Unlike the European directives, OSHA standards are more involved with formulating technical specifications than abstract requirements.

The legal basis in the USA can be seen as a mix of product standards, fire codes (NFPA), electrical codes (NEC) and national laws. Local government bodies have the authority to monitor that these codes are being enforced and implemented.

Russia and the CIS states have implemented GOST-R certification for some years now, in other words, technical devices that fall within a specific product area must undergo a cer-

tain certification process. Machinery and any corresponding technical accessories undergo a type approval test through a European notified body, for example. This test is generally recognised by a Russian-based approvals body. From the point of view of safety, the same requirements apply as in Europe.

China, on the other hand, has introduced CCC certification. Similar to the position in Russia, technical products are subject to mandatory certification through a national approvals body in China. In addition, production sites are inspected. If a technical device falls with the scope of the product list, which is subdivided into 19 categories, certification is mandatory, otherwise it will be necessary to supply a type of “declaration of no objection” from a national notified body.

Japan is currently in a transition period: The plan is for Japan to adopt the European “new approach” – in other words, to keep standards and legislation separate. At the moment the international ISO and IEC standards are being directly incorporated into national legislation, which is why people are currently confronted with frequent amendments to laws and lengthy implementation periods.

Standards for functional safety

Different standards may be called upon to observe functional safety on control systems, depending on the application. In the area of machine safety, EN ISO 13849-1 is the main standard named for safety-related

control systems. Irrespective of the technology, this applies for the whole chain from the sensor to the actuator. The risk graphs and corresponding risk parameters can be used to estimate the potential risk for danger zones on machinery. The category is then established without the use of risk-reducing measures.

Safety-related parts of control systems – General principles for design in accordance with EN ISO 13849-1

Determination of the required Performance Level (PL_r)

► S – Severity of injury

- S₁ = Slight (normally reversible injury)
- S₂ = Serious (normally irreversible injury, including death)

► F – Frequency and/or exposure to a hazard

- F₁ = Seldom to less often and/or the exposure time is short
- F₂ = Frequent to continuous and/or the exposure time is long

► P – Possibility of avoiding the hazard or limiting the harm

- P₁ = Possible under specific conditions
- P₂ = Scarcely possible

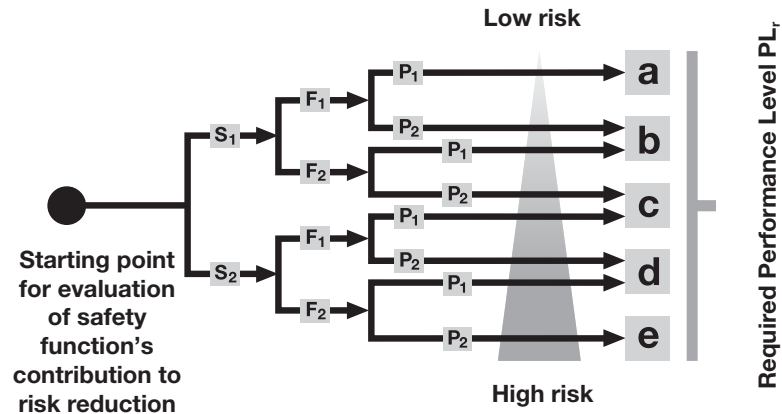

Safety-related parts of control systems – General principles for design in accordance with EN ISO 13849-1

As the successor standard to EN 954-1, EN ISO 13849-1 is based on the familiar categories. Equally, it examines complete safety functions, including all the components involved in their design. EN ISO 13849-1 goes beyond the qualitative approach of EN 954-1 to include a quantitative assessment of the safety functions. A performance level (PL) is used for this, building upon the categories.

Components/devices require the following safety parameters:

- Category (structural requirement)
- PL: Performance level
- MTTF_d: Mean time to dangerous failure
- DC: Diagnostic coverage
- CCF: Common cause failure

The standard describes how to calculate the performance level (PL) for safety-related parts of control systems, based on designated architectures. EN ISO 13849-1 refers any deviations to IEC 61508.

Risk assessment in accordance with EN ISO 13849-1

Risk assessment is an iterative process, i.e. it will need to be carried out more than once. The risk must be estimated and the performance level defined for each hazard on which the risk is to be reduced through control measures. The risk is estimated through consideration of the severity of injury (S), the frequency and duration of exposure to the hazard (F) and the possibility of avoiding or limiting the harm (P).

Parameters S, F and P are used on the risk graph to determine the required performance level (PL_r) for a safety function. The selection of parameters is no different to the procedure used in EN 954-1 (1996). However, the result is no longer a category but a PL.

Safety-related parts of control systems – General principles for design in accordance with EN ISO 13849-1

Performance Levels (PL) in accordance with EN ISO 13849-1	Probability of a dangerous failure per hour [1/h]
a	$10^{-5} < PFH < 10^{-4}$
b	$3 \times 10^{-6} < PFH < 10^{-5}$
c	$10^{-6} < PFH < 3 \times 10^{-6}$
d	$10^{-7} < PFH < 10^{-6}$
e	$10^{-8} < PFH < 10^{-7}$

Performance level

The performance level (PL) classifies 5 levels of probability of failure. The table shows the relationship between PL and the probability of dangerous failure per hour PFH_D .

Once the required PL has been established, the PL achieved by the safety function (SRP/CL) is calculated. To do this the SRP/CL can be divided into logical blocks, such as input, logic solving and output for example.

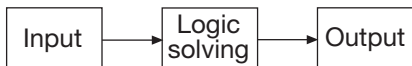

When using a designated architecture or an architecture of similar structure, the achieved PL can be calculated graphically using the bar chart. To do this the architecture of the SRP/CL is divided into categories. $MTTF_D$ and DC_{avg} are also required. From Category 2 onwards, the CCF will also need to be

examined. A component's $MTTF_D$ value is usually provided by the manufacturer. The standard provides tables and check lists for calculating the other values.

It is also possible to calculate the achieved PL of an SRP/CL. The probability of dangerous failure of all the blocks that combine to form the safety function is added up:

$$PFH_{System} = PFH_{Input} + PFH_{Logic} + PFH_{Output}$$

The PL achieved by an SRP/CL must be at least as high as the PL required by the safety function.

If this condition is not met, the safety function must be implemented differently.

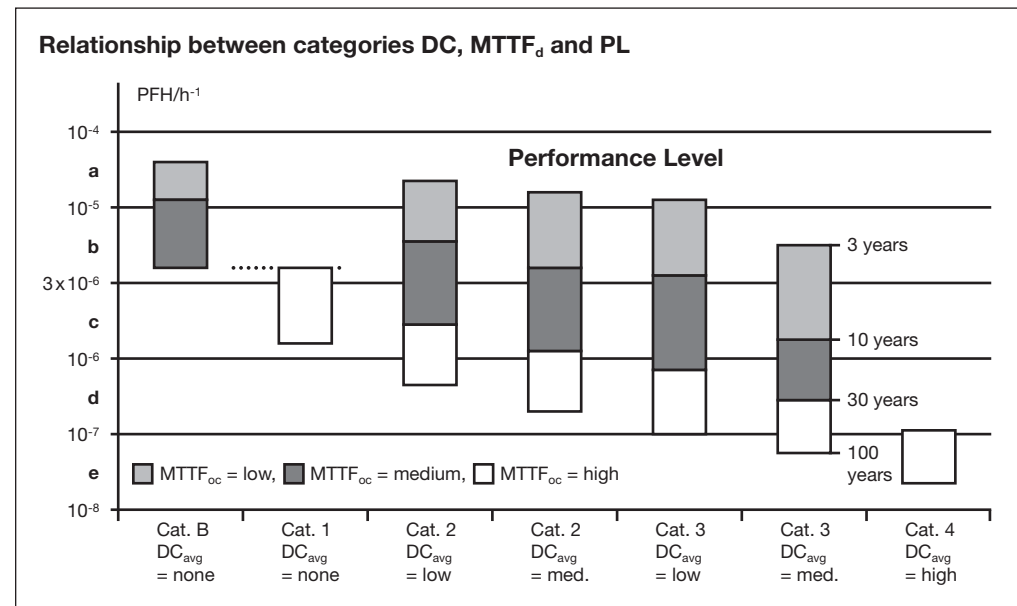

Functional safety and legal position of EN/IEC 61508

Functional safety with EN/IEC 61508?

EN/IEC 61508 is regarded as a generic safety standard, which deals with the functional safety of electrical, electronic and programmable electronic systems, irrespective of the application.

One of the main tasks of EN/IEC 61508 is to serve as a basis for the development of application-oriented standards. Standards' committees are currently busy in the areas of machine safety with EN/IEC 62061, and process safety with EN/IEC 61511.

These sector-specific standards are intended to continue the principle approaches of EN/IEC 61508 and to implement the requirements for the relevant application area in a suitably practical manner.

What is the legal status of EN/IEC 61508?

As EN/IEC 61508 is not listed in the Official Journal of the European Communities for implementation as a European directive, it lacks the so-called "effect of presumption", so if the standard is used on its own, a control system designer cannot presume that the relevant requirements of the specific European directive have been met.

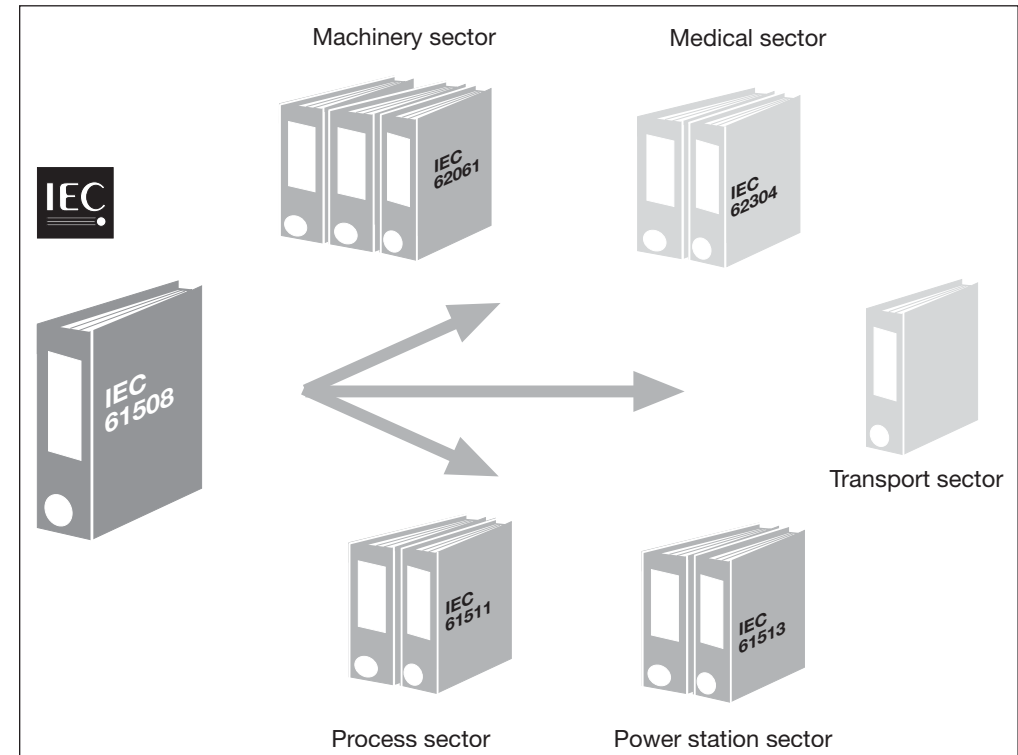

Sector standards from EN/IEC 61508

Functional safety in accordance with EN/IEC 62061

Risk assessment and determination of required Safety Integrity Level (SIL)												
Consequences	S	Class CI					Frequency and duration	Fr	Probability of hzd. event	Pr	Avoidance	
		3-4	5-7	8-10	11-13	14-15					P	
Death, losing an eye or arm	4	SIL 2	SIL 2	SIL 2	SIL 3	SIL 3	≤ 1 hour	5	Very high	5		
Permanent, losing fingers	3		OM	SIL 1	SIL 2	SIL 3	> 1 h – ≤ 1 day	5	Likely	4		
Reversible, medical attention	2			OM	SIL 1	SIL 2	> 1 day – ≤ 2 wks	4	Possible	3	Impossible	5
Reversible, first aid	1				OM	SIL 1	> 2 wks – ≤ 1 year	3	Rarely	2	Possible	3
							> 1 year	2	Negligible	1	Likely	1

AM = Other measures recommended

Functional safety of safety-related electrical, electronic and programmable electronic control systems in accordance with EN/IEC 62061

EN/IEC 62061 represents a sector-specific standard under EN/IEC 61508. It describes the implementation of safety-related electrical control systems on machinery and examines the overall lifecycle from the concept phase through to decommissioning. Quantitative and qualitative examinations of the safety functions form the basis.

Risk estimation is an iterative process, i.e. it will need to be carried out more than once. The risk must be estimated and the SIL defined for each hazard on which the risk is to be reduced through control measures. The risk is estimated through consideration of the severity of injury (Se), the frequency and duration of exposure to the hazard (Fr), probability of occurrence of a hazardous event (Pr) and the possibility of avoiding or limiting the harm (Av).

The required SIL is assigned using the table above, where $CI = Fr + Pr + Av$.

Functional safety in accordance with EN/IEC 62061

Safety Integrity Level (SIL) in accordance with EN IEC 62061	Probability of a dangerous failure per hour [1/h]
No special safety requirement	$10^{-5} < PFH < 10^{-4}$
1 (1 failure in 100 000 h)	$3 \times 10^{-6} < PFH < 10^{-5}$
1 (1 failure in 100 000 h)	$10^{-6} < PFH < 3 \times 10^{-6}$
2 (1 failure in 1 000 000 h)	$10^{-7} < PFH < 10^{-6}$
3 (1 failure in 10 000 000 h)	$10^{-8} < PFH < 10^{-7}$

SIL assignment

The safety integrity level (SIL) classifies three levels of probability of failure. The table shows the relationship between SIL and the probability of dangerous failure per hour (PFH_D).

The SRECS (safety-related electrical control system) is divided into subsystems. The subsystems are assigned to actual devices. The SIL must be defined for each subsystem.

The probability of a dangerous failure is calculated by adding the probabilities of failure of all the subsystems of the SRECS:

$$PFH_D = PFH_{D1} + \dots + PFH_{Dn}$$

The selection or design of the SRECS must always meet the following minimum requirements:

Requirements for hardware safety integrity, comprising

- ▶ Architectural constraints for hardware safety integrity
- ▶ Requirements for the probability of dangerous random hardware failures

plus requirements for systematic safety integrity, comprising

- ▶ Requirements for avoidance of failures and
- ▶ Requirements for the control of systematic failures.

The following parameters are required in assessing hardware safety integrity:

- λD: Dangerous failure rate
- T1: Proof test
- T2: Diagnostic test interval
- DC: Diagnostic coverage
- β: Common cause failure

The calculated probability of failure (PFHD) of each SRECS must be less than the probability of failure required by the safety function. The required probability of failure, depending on the SIL, can be taken from the table. If this condition is not met, the safety function must be implemented differently.

The achieved SIL can only be as high as the lowest SILCL (SIL Claim Limit) of a subsystem involved in performing the safety function.

Safe failure fraction (SFF)	Hardware fault tolerance 0	Hardware fault tolerance 1	Hardware fault tolerance 2
< 60 %	Not allowed	SIL 1	SIL 2
60 % – < 90 %	SIL 1	SIL 2	SIL 3
90 % – < 99 %	SIL 2	SIL 3	SIL 3
99 %	SIL 3	SIL 3	SIL 3

Risk parameters and categories in accordance with EN 954-1/EN ISO 13849-1¹⁾

Risk parameters

S = Severity of injury:

- 1 = Slight (normally reversible) injury
- 2 = Serious (normally irreversible) injury, including death

F = Frequency and/or exposure to the hazard:

- 1 = Seldom to quite often and/or exposure time is short
- 2 = Frequent to continuous and/or exposure time is long

P = Possibility of avoiding the hazard:

- 1 = Possible under specific conditions
- 2 = Scarcely possible

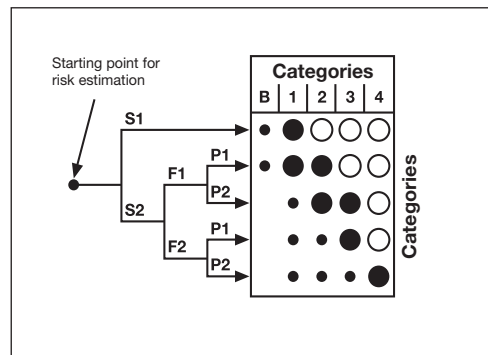

Risk graph from EN 954

Categories in accordance with EN 954-1

The control system requirements derived from the risk graph are specified as follows:

Category B

Basic category with no special requirements = "good industrial standard"

Category 1

Safety-related parts must be designed and constructed using well-tried components and well-tried safety principles.

Well-tried means: the components have been widely used in the past with successful results in similar applications, or they have been manufactured using principles that demonstrate its suitability and reliability for safety-related applications.

Example: safety switch with forced-opening contacts.

Well-tried safety principles are circuits that are constructed in such a way that certain faults can be avoided by the appropriate arrangement or layout of components.

Example: avoiding a short circuit through appropriate separation, avoiding component failures that result from overdimensioning, using the failsafe principle (on switching off).

Note: The occurrence of a fault can lead to the loss of the safety function.

Category 2

Safety-related parts of control systems must

be designed so that their safety function(s) are checked at suitable intervals by the machine control system. The safety function(s) must be checked: at the machine start-up and prior to the initiation of any hazardous situation; periodically during operation, if the risk assessment and the kind of operation show that it is necessary.

This check may be initiated automatically or manually. Automatically, for example, the check may be initiated by a signal generated from a control system at suitable intervals. The automatic test should be provided by preference. The decision about the type of test depends on the risk assessment and the judgement of the end user or machine builder. If no fault is detected, operation may be approved as a result of the test. If a fault is detected, an output must be generated to initiate appropriate control action. A second, independent shutdown route is required for this.

Notes: In some cases Category 2 is not applicable because the checking of the safety function cannot be applied to all components and devices. Moreover, the cost involved in implementing Category 2 correctly may be considerable, so that it may make better economic sense to implement a different category.

In general Category 2 can be realised with electronic techniques. The system behaviour allows the occurrence of a fault to lead to the loss of the safety function between checks; the loss of the safety function is detected by the check.

Category 3

Safety-related parts of control systems must be designed so that a single fault in any of these parts does not lead to the loss of the safety function.

Whenever reasonably practicable, the single fault shall be detected at or before the next demand upon the safety function.

This does not mean that all faults will be detected. The accumulation of undetected faults can lead to an unintended output signal and a hazardous situation at the machine.

Category 4

Safety-related parts of control systems must be designed so that a single fault in any of these parts does not lead to a loss of the safety function; the single fault must be detected at or before the next demand upon the safety functions (e.g. immediately at switch on, at the end of a machine operating cycle). If this detection is not possible, then an accumulation of faults shall not lead to a loss of the safety function.

¹⁾ Only applicable until November 2009. Replaced by EN ISO 13849-1

Contents		Page
Emergency stop applications		
PNOZ s3	– Dual-channel operation, contact expansion through contactor	PL d of EN ISO 13849-1, SIL 2 of EN 62061 2.1-2
PNOZ s3	– Dual-channel operation, contact expansion through PZE X4.1P	PL e of EN ISO 13849-1, SIL 3 of EN 62061 2.1-5
PNOZ s4	– Dual-channel operation, contact expansion through contactor	PL e of EN ISO 13849-1, SIL 3 of EN 62061 2.1-8
PNOZ s5	– Safe standstill of one drive	PL e of EN ISO 13849-1, SIL 3 of EN 62061 2.1-11
PNOZ s5	– Safe standstill of two drives	PL e of EN ISO 13849-1, SIL 3 of EN 62061 2.1-14
PNOZ s5	– Combined with two PNOZ s7	PL e of EN ISO 13849-1, SIL 3 of EN 62061 2.1-19
PNOZ s7	– Combined with PNOZ s4	PL e of EN ISO 13849-1, SIL 3 of EN 62061 2.1-23
PNOZ s9	– Combined with PNOZ s4, safe standstill of one drive	PL e of EN ISO 13849-1, SIL 3 of EN 62061 2.1-26
PNOZ s10	– Combined with PNOZ s4	PL e of EN ISO 13849-1, SIL 3 of EN 62061 2.1-29

PL d of EN ISO 13849-1, SIL 2 of EN 62061

PNOZ s3 - Dual-channel operation, contact expansion through contactor

Features

- ▶ Dual-channel operation
- ▶ Monitored reset with falling edge
- ▶ Contact expansion through positive-guided contactors
- ▶ Feedback loop to monitor contact expansion

Description

E-STOP function

When the E-STOP pushbutton S1 is operated, the input circuit on the safety relay PNOZ s3 (K1) is interrupted, the safety contacts on K1 open. Contactors KM1 and KM2 de-energise.

Settings on the unit

- ▶ The terminator on the PNOZ s3 (K1) must be connected.
- ▶ The operating mode selector switch (mode) on the safety relay PNOZ s3 (K1) must be set to "Monitored reset, falling edge without detection of shorts across contacts (In2+)".

Start/reset

The safety relay PNOZ s3 (K1) can be started by pressing reset button S2 if:

- ▶ E-STOP pushbutton S1 has not been operated and
- ▶ Contactors KM1 and KM2 have de-energised.

Feedback loop

The positive-guided N/C contacts on contactors KM1 and KM2 are monitored in feedback loop S12-S34 of safety relay PNOZ s3 (K1).

Safety assessment

- ▶ The safety relay K1 and contactors KM1 and KM2 must be installed in a single mounting area (control cabinet) in order to exclude a short across the output.
- ▶ Earth fault in the input circuit is detected.
- ▶ A fault on the device does not lead to the loss of the safety function.
- ▶ The safety relay PNOZ s3 (K1) can be started when the input circuit at K1 is closed first, followed by reset button S2. This avoids an unwanted reset before the input circuit is closed or as a result of the reset button being overridden.
- ▶ If the position of the operating mode selector switch (mode) is changed during operation, an error message will be triggered; the safety contacts on K1 open. This fault condition can only be rectified by switching the supply voltage on the safety relay PNOZ s3 (K1) off and then on again.

Pilz products

Number	Designation	Order number
1	PNOZ s3	750 103
1	PITestop Set1.1	400 410

Emergency Stop Applications

PL d of EN ISO 13849-1, SIL 2 of EN 62061

PNOZ s3 - Dual-channel operation, contact expansion through contactor

Safety-related characteristics in accordance with EN ISO 13849-1

Prerequisites:

- ▶ Common cause failure (CCF): Requirements are considered to be met (must be tested on implementation)
- ▶ Mission time: 20 years
- ▶ Operating interval (electromechanical components):
 - Sensor: One operation per week
 - Actuator: One operation per week
- ▶ Characteristic data of contactors KM1/KM2: B10d: 2,000,000

EN ISO 13849-1		Performance Level	Safety-related parts of the control system
Safety function:	Machine shut down via E-STOP	PL d	Sensor (PITestop S1) Logic (PNOZ s3) Actuator (contactors KM1, KM2)

Please note the further requirements of EN ISO 13849-1, e.g. requirements for avoiding systematic faults.

Safety-related characteristics in accordance with EN 62061

Prerequisites:

- ▶ Common cause failure (CCF): $\beta = 2 \%$ (must be tested on implementation)
- ▶ Proof test interval: 20 years
- ▶ Operating interval (electromechanical components):
 - Sensor: One operation per week
 - Actuator: One operation per week
- ▶ Characteristic data of contactors KM1/KM2: B10d: 2,000,000
Dangerous failure rate: 65%

EN 62061		Safety Integrity Level	Subsystems
Safety-related control function (SRCF):	Machine shut down via E-STOP	SIL 2	Sensor (PITestop S1) Logic (PNOZ s3) Actuator (contactors KM1, KM2)

Please note the further requirements of EN 62061, e.g. requirements for systematic safety integrity.

Classification in accordance with EN 954-1

Depending on the application area and its respective regulations, this connection example is suitable for applications up to Category 3 of EN 954-1.

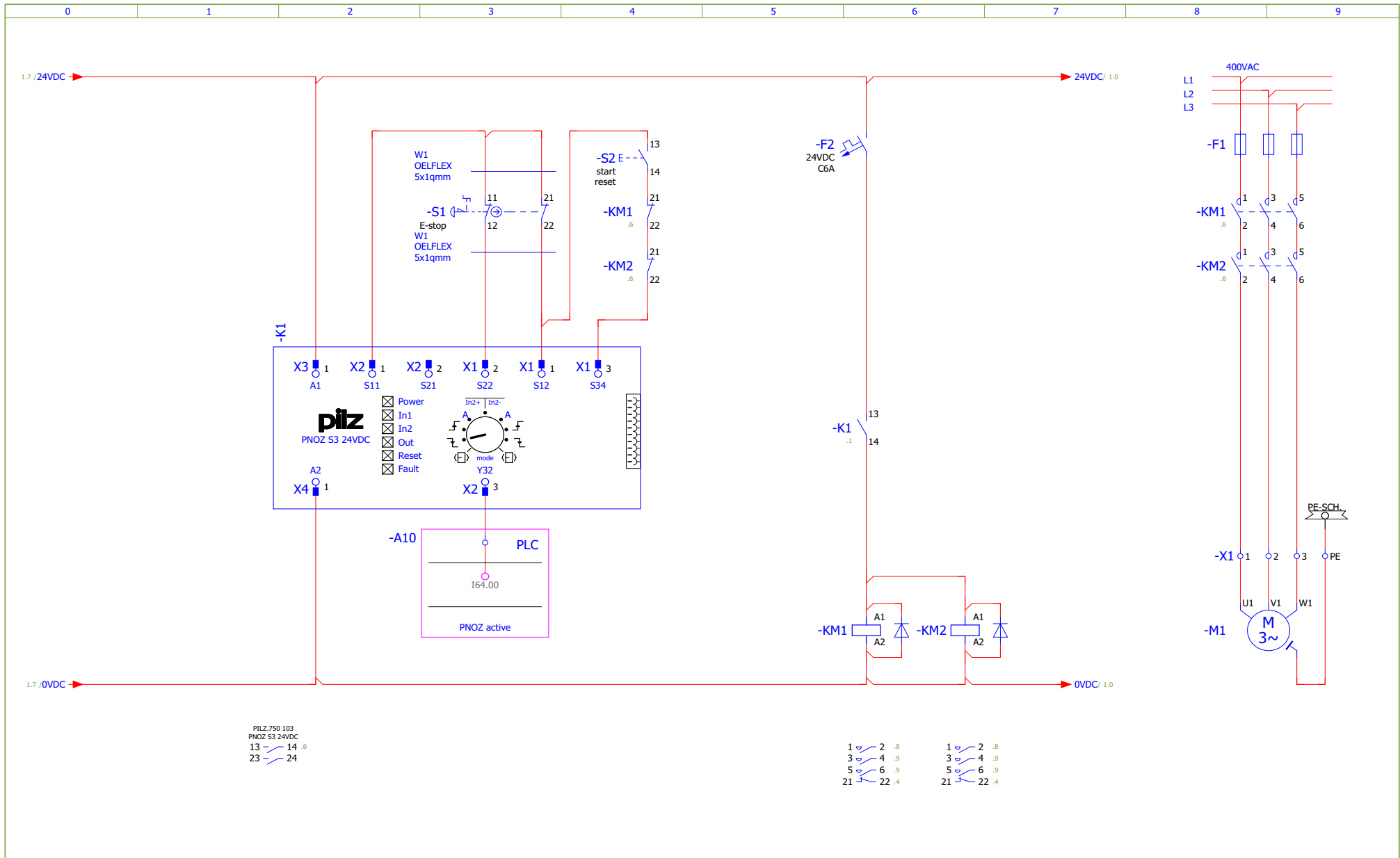

Revision	15.01.2009	Date	07.12.2005	EN ISO 13849-1:2006	PL d	Pilz GmbH & Co.KG Felix-Wankel-Str.2 73760 Ostfildern	Emergency stop, extension contact by contactor and monitored start	Mounting place	+ PNOZs3_1
Name	RDS	Name	WED	EN 62061:2005	SIL 2			Page:	1 / 1
		Dep.	CS						

PL e of EN ISO 13849-1, SIL 3 of EN 62061

PNOZ s3 - Dual-channel operation, contact expansion through PZE X4.1P

Features

- ▶ Dual-channel operation with detection of shorts across contacts
- ▶ Monitored reset with falling edge
- ▶ Contact expansion through PZE X4.1P (contact expander module)
- ▶ Feedback loop to monitor contact expansion

Description

E-STOP function

When the E-STOP pushbutton S5 is operated, the input circuit on the safety relay PNOZ s3 (K5) is interrupted, the safety contacts on K5 open. As a result the input circuit on the contact expander module PZE X4.1P (K6) is interrupted, the safety contacts on K6 open.

Settings on the unit

- ▶ The terminator on the PNOZ s3 (K5) must be connected.
- ▶ The operating mode selector switch (mode) on the safety relay PNOZ s3 (K5) must be set to "Monitored reset, falling edge with detection of shorts across contacts (In2-)".

Start/reset

The safety relay PNOZ s3 (K5) can be started by pressing reset button S6 if:

- ▶ E-STOP pushbutton S5 has not been operated and
- ▶ Feedback loop Y1/Y2 on contact expander module PZE X4.1P (K6) is closed and
- ▶ Contactors KM1 and KM2 have de-energised.

Feedback loop

The feedback loop on the safety relay PNOZ s3 (K5) is connected to the feedback loop on the contact expander module PZE X4.1P (K6).

The positive-guided N/C contacts on contactors KM1 and KM2 are monitored in feedback loop S12-S34 of safety relay PNOZ s3 (K5).

Safety assessment

- ▶ The safety relay K1 and the contactors KM1 and KM2 must be installed in a single mounting area (control cabinet) in order to exclude a short across the output.
- ▶ Earth faults and shorts between contacts in the input circuit are detected.
- ▶ A fault on the device does not lead to the loss of the safety function.
- ▶ The safety relay PNOZ s3 (K5) can be started when the input circuit at K5 is closed first, followed by reset button S6. This avoids an unwanted reset before the input circuit is closed or as a result of the reset button being overridden.

- ▶ If the position of the operating mode selector switch (mode) is changed during operation, an error message will be triggered; the safety contacts on K5 open. This fault condition can only be rectified by switching the supply voltage on the safety relay PNOZ s3 (K5) off and then on again.

Pilz products

Number	Designation	Order number
1	PNOZ s3	750 103
1	PZE X4.1P	777 587
1	PITestop Set1.1	400 410

Emergency Stop Applications

PL e of EN ISO 13849-1, SIL 3 of EN 62061

PNOZ s3 - Dual-channel operation, contact expansion through PZE X4.1P

Safety-related characteristics in accordance with EN ISO 13849-1

Prerequisites:

- ▶ Common cause failure (CCF): Requirements are considered to be met (must be tested on implementation)
- ▶ Mission time: 20 years
- ▶ Operating interval (electromechanical components):
 - Sensor: One operation per week
 - Actuator: One operation per week
- ▶ Characteristic data of contactors KM1/KM2: B10d: 2,000,000

EN ISO 13849-1		Performance Level	Safety-related parts of the control system
Safety function:	Machine shut down via E-STOP	PL e	Sensor (PITestop S5) Logic (PNOZ s3) Logic (PZE X4.1P) Actuator (contactors KM1, KM2)

Please note the further requirements of EN ISO 13849-1, e.g. requirements for avoiding systematic faults.

Safety-related characteristics in accordance with EN 62061

Prerequisites:

- ▶ Common cause failure (CCF): $\beta = 2 \%$ (must be tested on implementation)
- ▶ Proof test interval: 20 years
- ▶ Operating interval (electromechanical components):
 - Sensor: One operation per week
 - Actuator: One operation per week
- ▶ Characteristic data of contactors KM1/KM2: B10d: 2,000,000
Dangerous failure rate: 65%

EN 62061		Safety Integrity Level	Subsystems
Safety-related control function (SRCF):	Machine shut down via E-STOP	SIL 3	Sensor (PITestop S5) Logic (PNOZ s3) Logic (PZE X4.1P) Actuator (contactors KM1, KM2)

Please note the further requirements of EN 62061, e.g. requirements for systematic safety integrity.

Classification in accordance with EN 954-1

Depending on the application area and its respective regulations, this connection example is suitable for applications up to Category 4 of EN 954-1.

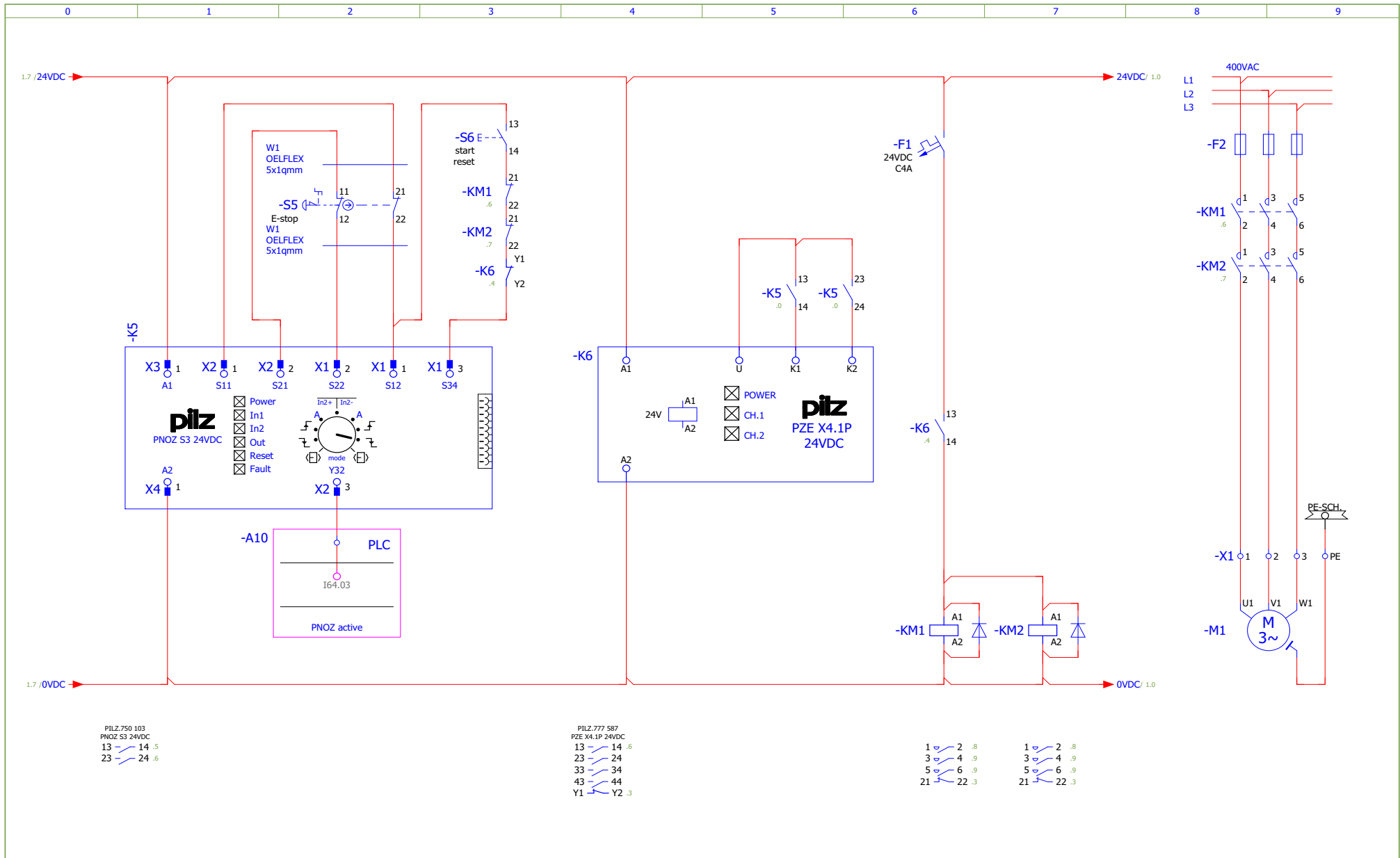

Revision	15.01.2009	Date	07.12.2005	EN ISO 13849-1:2006	PL e	 Pilz GmbH & Co.KG Felix-Wankel-Str.2 73760 Ostfildern	Emergency stop, extension contact by PZE X4.1P and monitored start	Mounting place + PNOZs3_3
Name	RDS	Name	WED	EN 62061:2005	SIL 3		Page:	1 / 1
		Dep.	CS					

PL e of EN ISO 13849-1, SIL 3 of EN 62061

PNOZ s4 - Dual-channel operation, contact expansion through contactor

Features

- ▶ Dual-channel operation with detection of shorts across contacts
- ▶ Monitored reset with falling edge
- ▶ Contact expansion through positive-guided contactors
- ▶ Feedback loop to monitor contact expansion

Description

E-STOP function

When the E-STOP pushbutton S1 is operated, the input circuit on the safety relay PNOZ s4 (K1) is interrupted, the safety contacts on K1 open. Contactors KM1 and KM2 de-energise.

Settings on the unit

- ▶ The terminator on the PNOZ s4 (K1) must be connected.
- ▶ The operating mode selector switch (mode) on the safety relay PNOZ s4 (K1) must be set to “Monitored reset, falling edge with detection of shorts across contacts (In2-)”.

Start/reset

The safety relay PNOZ s4 (K1) can be started by pressing reset button S2 if:

- ▶ E-STOP pushbutton S1 has not been operated and
- ▶ Contactors KM1 and KM2 have de-energised.

Feedback loop

The positive-guided N/C contacts on contactors KM1 and KM2 are monitored in feedback loop S12-S34 of safety relay PNOZ s4 (K1).

Safety assessment

- ▶ The safety relay PNOZ s4 (K1) and contactors KM1 and KM2 must be installed in a single mounting area (control cabinet) in order to exclude a short across the output.
- ▶ Earth faults and shorts between contacts in the input circuit are detected.
- ▶ A fault on the device does not lead to the loss of the safety function.
- ▶ The safety relay PNOZ s4 (K1) can be started when the input circuit at K1 is closed first, followed by reset button S2. This avoids an unwanted reset before the input circuit is closed or as a result of the reset button being overridden.
- ▶ If the position of the operating mode selector switch (mode) is changed during operation, an error message will be triggered; the safety contacts on K1 open. This fault condition can only be rectified by switching the supply voltage on the safety relay PNOZ s4 (K1) off and then on again.

Pilz products

Number	Designation	Order number
1	PNOZ s4	750 104
1	PITestop Set1.1	400 410

Emergency Stop Applications

PL e of EN ISO 13849-1, SIL 3 of EN 62061

PNOZ s4 - Dual-channel operation, contact expansion through contactor

Safety-related characteristics in accordance with EN ISO 13849-1

Prerequisites:

- ▶ Common cause failure (CCF): Requirements are considered to be met (must be tested on implementation)
- ▶ Mission time: 20 years
- ▶ Operating interval (electromechanical components):
 - Sensor: One operation per week
 - Actuator: One operation per week
- ▶ Characteristic data of contactors KM1/KM2: B10d: 2,000,000

EN ISO 13849-1		Performance Level	Safety-related parts of the control system
Safety function:	Machine shut down via E-STOP	PL e	Sensor (PITestop S1) Logic (PNOZ s4) Actuator (contactors KM1, KM2)

Please note the further requirements of EN ISO 13849-1, e.g. requirements for avoiding systematic faults.

Safety-related characteristics in accordance with EN 62061

Prerequisites:

- ▶ Common cause failure (CCF): $\beta = 2 \%$ (must be tested on implementation)
- ▶ Proof test interval: 20 years
- ▶ Operating interval (electromechanical components):
 - Sensor: One operation per week
 - Actuator: One operation per week
- ▶ Characteristic data of contactors KM1/KM2: B10d: 2,000,000
Dangerous failure rate: 65%

EN 62061		Safety Integrity Level	Subsystems
Safety-related control function (SRCF):	Machine shut down via E-STOP	SIL 3	Sensor (PITestop S1) Logic (PNOZ s4) Actuator (contactors KM1, KM2)

Please note the further requirements of EN 62061, e.g. requirements for systematic safety integrity.

Classification in accordance with EN 954-1

Depending on the application area and its respective regulations, this connection example is suitable for applications up to Category 4 of EN 954-1.

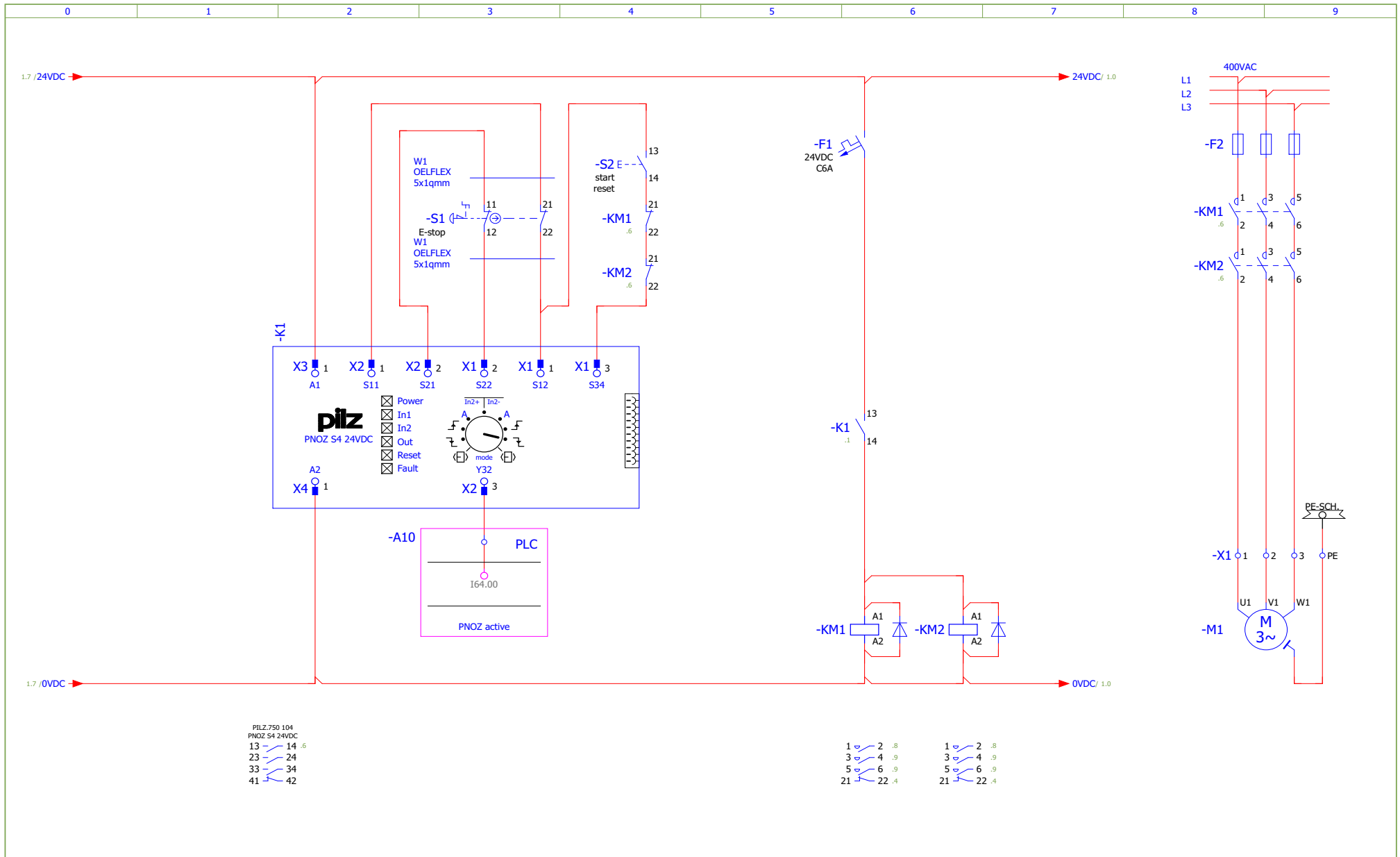

Revision	15.01.2009	Date	07.12.2005	EN ISO 13849-1:2006	PL e	Pilz GmbH & Co.KG Felix-Wankel-Str.2 73760 Ostfildern	Emergency stop, extension contact by contactor and monitored start	Mounting place + PNOZs4_1
Name	RDS	Name	WED	EN 62061:2005	SIL 3		Page:	1 / 1
		Dep.	CS					

PL e of EN ISO 13849-1, SIL 3 of EN 62061

PNOZ s5 - Safe standstill of one drive

Features

- ▶ Dual-channel operation with detection of shorts across contacts
- ▶ Monitored reset with falling edge
- ▶ Safe standstill of one drive after E-STOP
- ▶ Contact expansion through positive-guided contactors
- ▶ Feedback loop to monitor contact expansion
- ▶ Stop category 1 in accordance with EN 60204-1

Description

E-STOP function

When the E-STOP pushbutton S1 is operated, both the drive and the supply to the drive are shut down after a delay time. When the E-STOP pushbutton S1 is operated, the input circuit on the safety relay PNOZ s5 (K1) is interrupted, safety contact 13-14 on K1 opens immediately and triggers a “fast stop” at the drive controller A1.

The delay-on de-energisation safety contact 37-38 switches off contactors KM1 and KM2 after a delay. In this way, the drive controller A1 is isolated from the energy supply (mains) after a delay. The delay-on de-energisation time is set on the safety relay PNOZ s5 (K1).

Settings on the unit

- ▶ The terminator on the PNOZ s5 (K1) must be connected.
- ▶ The operating mode selector switch (mode) on the safety relay PNOZ s5 (K1) must be set to “Monitored reset, falling edge with detection of shorts across contacts (In2-)”.
- ▶ The delay time on the safety relay PNOZ s5 (K1) is set using the time selector switch t[s] and the factor selector switch n.

Start/reset

The safety relay PNOZ s5 (K1) can be started by pressing reset button S2 if:

- ▶ E-STOP pushbutton S1 has not been operated and
- ▶ Contactors KM1 and KM2 have de-energised.

Feedback loop

The positive-guided N/C contacts on contactors KM1 and KM2 are monitored in feedback loop S12-S34 of safety relay PNOZ s5 (K1).

Safety assessment

- ▶ The safety relay (K1) and contactors KM1 and KM2 must be installed in a single mounting area (control cabinet) in order to exclude a short across the output.
- ▶ Earth faults and shorts between contacts in the input circuit are detected.

- ▶ A fault on the device does not lead to the loss of the safety function.
- ▶ The safety relay PNOZ s5 (K1) can be started when the input circuit at K1 is closed first, followed by reset button S2. This avoids an unwanted reset before the input circuit is closed or as a result of the reset button being overridden.
- ▶ The delay time set for the safety relay PNOZ s5 (K1) must be longer than the maximum braking time on the drive regulator A1.
- ▶ The time delay must not be able to cause an additional hazard.
- ▶ If the position of the operating mode selector switch (mode) or the rotary switch for the time setting is changed during operation, an error message will be triggered; the safety contacts on K1 open. This fault condition can only be rectified by switching the supply voltage on the safety relay PNOZ s5 (K1) off and then on again.

Pilz products

Number	Designation	Order number
1	PNOZ s5	750 105
1	PITestop Set1.1	400 410

Emergency Stop Applications

PL e of EN ISO 13849-1, SIL 3 of EN 62061

PNOZ s5 - Safe standstill of one drive

Safety-related characteristics in accordance with EN ISO 13849-1

Prerequisites:

- ▶ Common cause failure (CCF): Requirements are considered to be met (must be tested on implementation)
- ▶ Mission time: 20 years
- ▶ Operating interval (electromechanical components):
 - Sensor: One operation per week
 - Actuator: One operation per week
- ▶ Characteristic data of contactors KM1/KM2: B10d: 2,000,000

Safety-related characteristics in accordance with EN 62061

Prerequisites:

- ▶ Common cause failure (CCF): $\beta = 2 \%$ (must be tested on implementation)
- ▶ Proof test interval: 20 years
- ▶ Operating interval (electromechanical components):
 - Sensor: One operation per week
 - Actuator: One operation per week
- ▶ Characteristic data of contactors KM1/KM2: B10d: 2,000,000
Dangerous failure rate: 65%

Classification in accordance with EN 954-1

Depending on the application area and its respective regulations, this connection example is suitable for applications up to Category 4 of EN 954-1.

EN ISO 13849-1		Performance Level	Safety-related parts of the control system
Safety function:	Machine shut down via E-STOP	PL e	Sensor (PITestop S1) Logic (PNOZ s5) Actuator (contactors KM1, KM2)

Please note the further requirements of EN ISO 13849-1, e.g. requirements for avoiding systematic faults.

EN 62061		Safety Integrity Level	Subsystems
Safety-related control function (SRCF):	Machine shut down via E-STOP	SIL 3	Sensor (PITestop S1) Logic (PNOZ s5) Actuator (contactors KM1, KM2)

Please note the further requirements of EN 62061, e.g. requirements for systematic safety integrity.

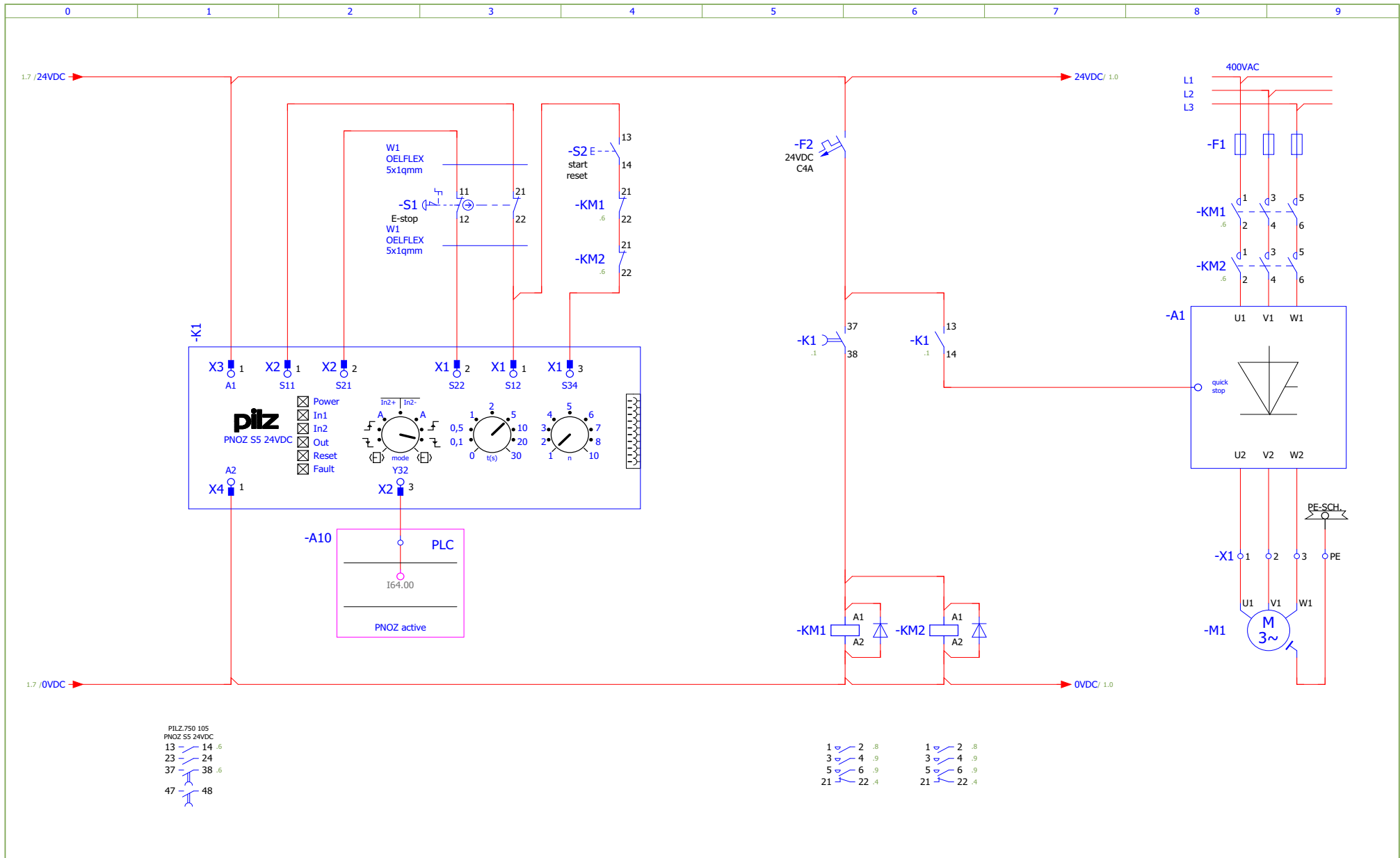

Revision	15.01.2009	Date	07.12.2005	EN ISO 13849-1:2006	PL e	Pilz GmbH & Co.KG Felix-Wankel-Str.2 73760 Ostfildern	Safe stopping of a drive by emergency stop	Mounting place	+ PNOZS5_1
Name	RDS	Name	WED	EN 62061:2005	SIL 3			Page:	1 / 1
		Dep.	CS						

PL e of EN ISO 13849-1, SIL 3 of EN 62061 PNOZ s5 - Safe standstill of two drives

Features

- ▶ Dual-channel operation with detection of shorts across contacts
- ▶ Monitored reset with falling edge
- ▶ Safe standstill of two drives after E-STOP
- ▶ Contact expansion through positive-guided contactors
- ▶ Feedback loop to monitor contact expansion
- ▶ Stop category 1 in accordance with EN 60204-1

Description

Both drive controllers A2 and A3 have different braking times, so it must be possible to separate them from the mains independently in terms of time.

E-STOP function

When the E-STOP pushbutton S3 is operated, both the drives and the supply to the drives are shut down after a delay time. When the E-STOP pushbutton S3 is operated, the input circuit on the safety relay PNOZ s5 (K2) is interrupted, safety contacts 13-14 and 23-24 on K2 open immediately and trigger a “fast stop” at both the drive controllers A2 and A3.

The delay-on de-energisation safety contact 37-38 on K2 switches off contactors KM3 and KM4 after a delay. In this way, the drive controller A2 is isolated from the energy supply (mains) after a delay. The delay-on

de-energisation time is set on the safety relay PNOZ s5 (K2). As a result the input circuit on safety relay PNOZ s9 (K3) is interrupted, the safety contacts on K3 switch off after a delay. The delay-on de-energisation contact 17-18 on K3 switches off contactors KM5 and KM6 after a delay. In this way, the drive controller A3 is isolated from the energy supply (mains) after a delay. The delay-on de-energisation time is set on the safety relay PNOZ s9 (K3).

Settings on the unit

- ▶ The connector between the safety relays PNOZ s5 (K2) and PNOZ s9 (K3) must be connected.
- ▶ The operating mode selector switch (mode) on the safety relay PNOZ s5 (K2) must be set to “Monitored reset, falling edge with detection of shorts across contacts (In2-)”.
- ▶ The delay time on the safety relays PNOZ s5 (K2) and PNOZ s9 (K3) is set using the time selector switch t[s] and the factor selector switch n.
- ▶ The operating mode selector switch (mode) on the safety relay PNOZ s9 (K3) must be set to “Delay-on de-energisation, not retriggerable”.

Start/reset

The safety relay PNOZ s5 (K2) can be started by pressing reset button S4 if:

- ▶ E-STOP pushbutton S3 has not been operated and
- ▶ Contactors KM3, KM4, KM5 and KM6 have dropped out and

- ▶ the feedback loop on safety relay PNOZ s9 (K3) is closed.

Feedback loop

The positive-guided N/C contacts on contactors KM3, KM4, KM5 and KM6 are monitored in feedback loop S12-S34 of safety relay PNOZ s5 (K2). The feedback loop on the safety relay PNOZ s5 (K2) is connected to the feedback loop on the safety relay PNOZ s9 (K3).

Pilz products

Number	Designation	Order number
1	PNOZ s5	750 105
1	PNOZ s9	750 109
1	PITestop Set1.1	400 410

PL e of EN ISO 13849-1, SIL 3 of EN 62061

PNOZ s5 - Safe standstill of two drives

Safety assessment

- ▶ The safety relays PNOZ s5 (K2), PNOZ s9 (K3) and contactors KM3, KM4, KM5 and KM6 must be installed in a single mounting area (control cabinet) in order to exclude a short across the output.
- ▶ Earth faults and shorts between contacts in the input circuit are detected.
- ▶ A fault on the device does not lead to the loss of the safety function.
- ▶ The safety relays PNOZ s5 (K2) and PNOZ s9 (K3) can be started when the input circuit at K2 is closed first, followed by reset button S4. This avoids an unwanted reset before the input circuit is closed or as a result of the reset button being overridden.
- ▶ The delay time set for the safety relay PNOZ s5 (K2) must be longer than the maximum braking time on the drive regulator A2. The delay time set for the safety relay PNOZ s9 (K3) must be longer than the maximum braking time on the drive regulator A3.
- ▶ The time delay must not be able to cause an additional hazard.
- ▶ If the position of the operating mode selector switch (mode) at K2 or the rotary switch for the time setting is changed during operation, an error message will be triggered; the safety contacts on K2 and K3 open. This fault condition can only be rectified by switching the supply voltage on the safety relay PNOZ s5 (K2) off and then on again.
- ▶ If the position of the operating mode selector switch (mode) at K3 or the rotary switch for the time settings is changed during operation, an error message will be triggered; the safety contacts on K3 open. This fault condition can only be rectified by switching the supply voltage on the safety relay PNOZ s9 (K3) off and then on again.

Emergency Stop Applications

PL e of EN ISO 13849-1, SIL 3 of EN 62061

PNOZ s5 - Safe standstill of two drives

Safety-related characteristics in accordance with EN ISO 13849-1

Prerequisites:

- ▶ Common cause failure (CCF): Requirements are considered to be met (must be tested on implementation)
- ▶ Mission time: 20 years
- ▶ Operating interval (electromechanical components):
 - Sensor: One operation per week
 - Actuator: One operation per week
- ▶ Characteristic data of contactors KM3/KM4/KM5/KM6:
B10d: 2,000,000

EN ISO 13849-1		Performance Level	Safety-related parts of the control system
Safety function 1:	Machine shut down via E-STOP	PL e	Sensor (PITestop S1) Logic (PNOZ s5) Actuator (contactors KM3, KM4)
Safety function 2:	Machine shut down via E-STOP	PL e	Sensor (PITestop S1) Logic (PNOZ s5) Logic (PNOZ s9) Actuator (contactors KM5, KM6)

Please note the further requirements of EN ISO 13849-1, e.g. requirements for avoiding systematic faults.

Safety-related characteristics in accordance with EN 62061

Prerequisites:

- ▶ Common cause failure (CCF): $\beta = 2 \%$ (must be tested on implementation)
- ▶ Proof test interval: 20 years
- ▶ Operating interval (electromechanical components):
 - Sensor: One operation per week
 - Actuator: One operation per week
- ▶ Characteristic data of contactors KM3/KM4/KM5/KM6:
B10d: 2,000,000
Dangerous failure rate: 65%

EN 62061		Safety Integrity Level	Subsystems
Safety-related control function 1 (SRCF1):	Machine shut down via E-STOP	SIL 3	Sensor (PITestop S1) Logic (PNOZ s5) Actuator (contactors KM3, KM4)
Safety-related control function 2 (SRCF2):	Machine shut down via E-STOP	SIL 3	Sensor (PITestop S1) Logic (PNOZ s5) Logic (PNOZ s9) Actuator (contactors KM5, KM6)

Please note the further requirements of EN 62061, e.g. requirements for systematic safety integrity.

Classification in accordance with EN 954-1

Depending on the application area and its respective regulations, this connection example is suitable for applications up to Category 4 of EN 954-1.

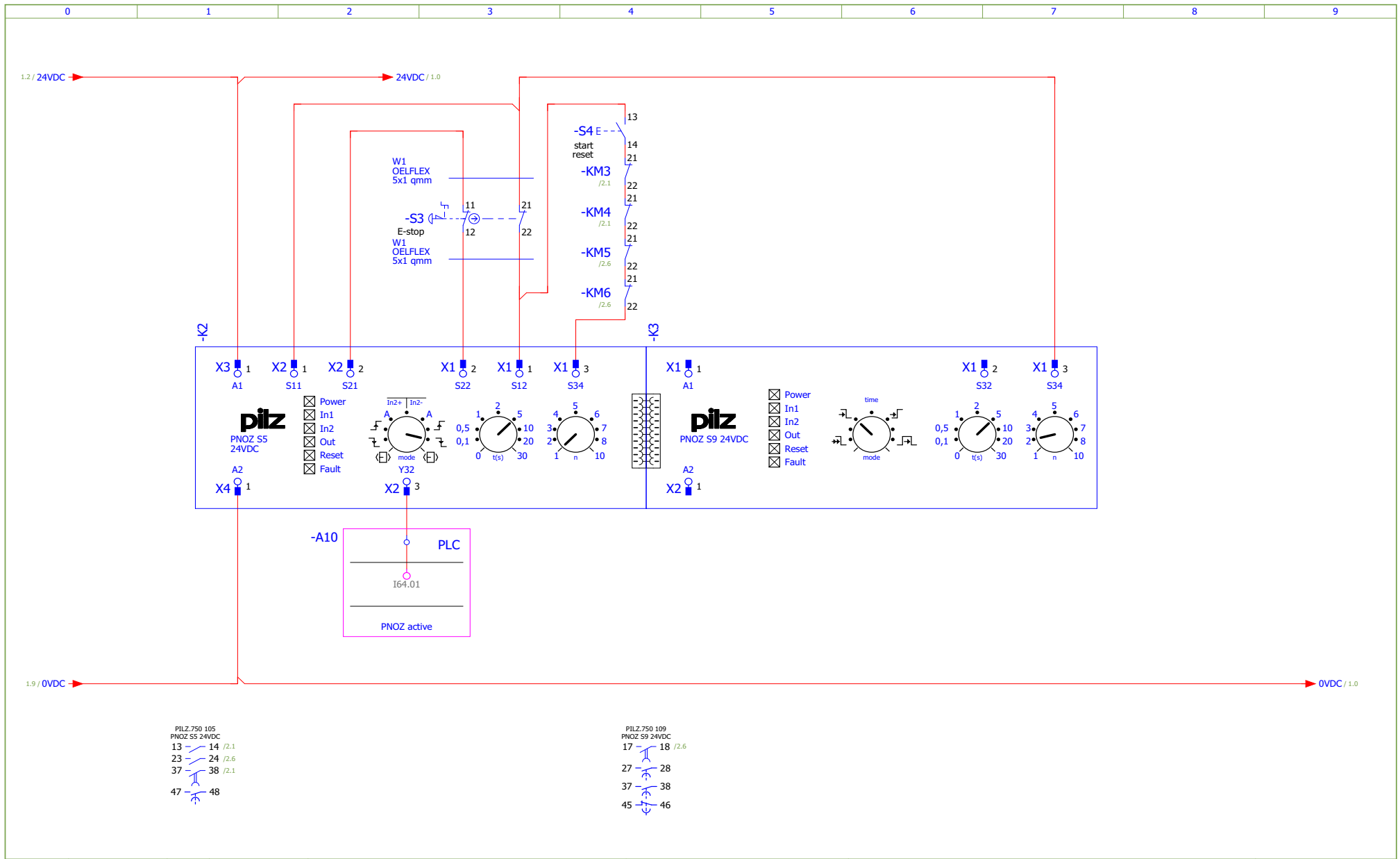

Revision	19.10.2009	Date	07.12.2005	EN ISO 13849-1:2006	PL e	 Pilz GmbH & Co.KG Felix-Wankel-Str.2 73760 Ostfildern	Safe stopping of two drives by emergency stop	Mounting place	+ PNOZs5_2
Name		Name	WED	EN 62061:2005	SIL 3			Page:	1 / 2
		Dep.	CS						

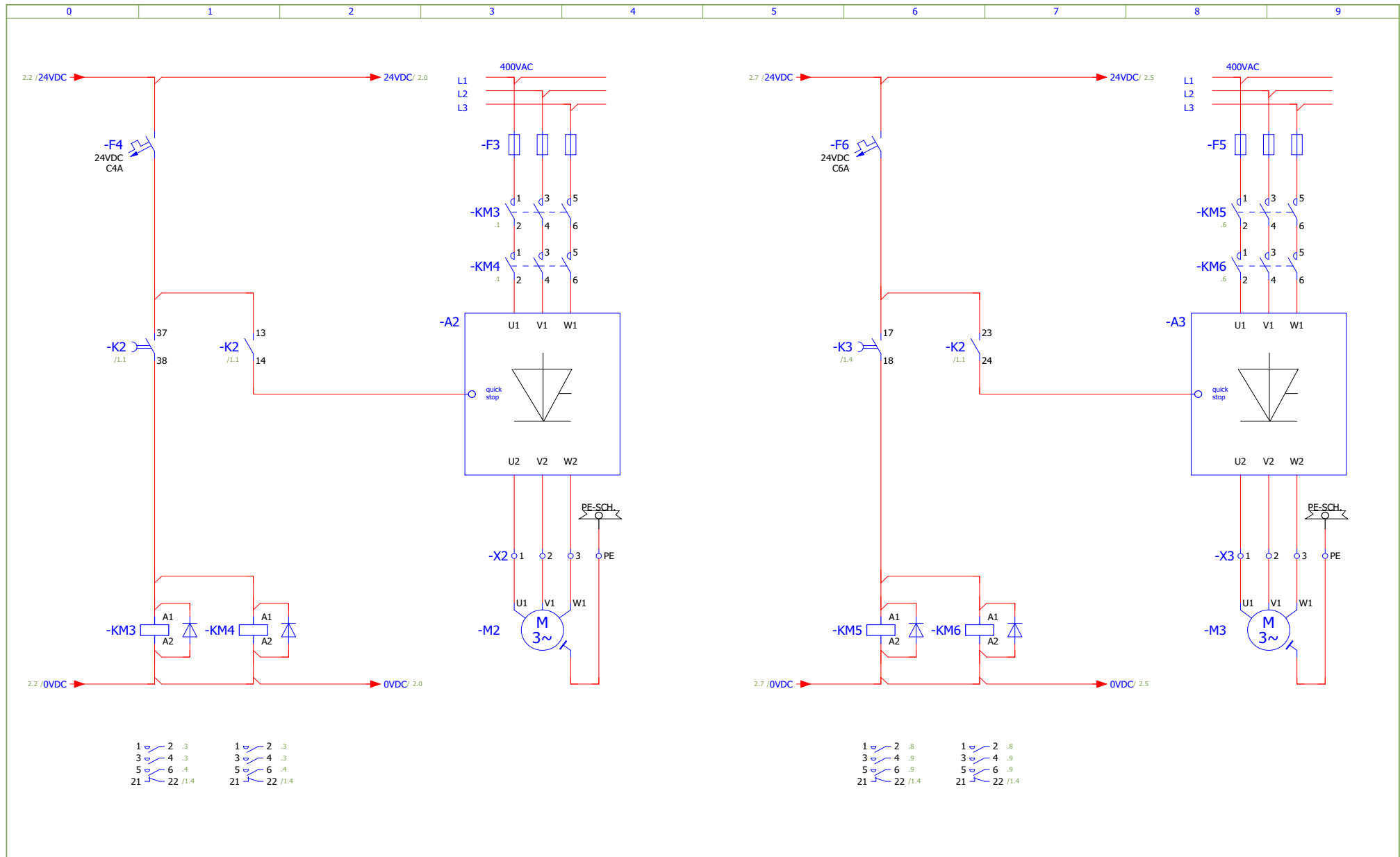

Revision	15.01.2009	Date	07.12.2005	EN ISO 13849-1:2006	PL e	 Pilz GmbH & Co.KG Felix-Wankel-Str.2 73760 Ostfildern	Safe stopping of two drives by emergency stop	Mounting place + PNOZs5_2
Name	RDS	Name	WED	EN 62061:2005	SIL 3			Page: 2 / 2
		Dep.	CS					

PL e of EN ISO 13849-1, SIL 3 of EN 62061

PNOZ s5 - Combined with two PNOZ s7

Features

- ▶ Dual-channel operation with detection of shorts across contacts
- ▶ Monitored reset with falling edge
- ▶ Contact expansion through two PNOZ s7
- ▶ Contact expansion through positive-guided contactors
- ▶ Feedback loop to monitor contact expansion
- ▶ No delayed safety contacts (time selector switch t[s] set to "0")

Description

E-STOP function

When the E-STOP pushbutton S5 is operated, the input circuit on the safety relay PNOZ s5 (K4) is interrupted, the safety contacts on K4 open. As a result the input circuit on the contact expander module PNOZ s7 (K5) is interrupted, the safety contacts on K5 open. As a result the supply voltage on the contact expander module PNOZ s7 (K6) is interrupted, the safety contacts on K6 open.

As the time selector switch t[s] is set to 0, all the safety contacts on the safety relay PNOZ s5 (K4) switch off immediately.

Settings on the unit

- ▶ The connector between the safety relays PNOZ s5 (K4) and PNOZ s7 (K5) must be connected.
- ▶ The terminator on the PNOZ s7 (K6) must be connected.
- ▶ The operating mode selector switch (mode) on the safety relay PNOZ s5 (K4) must be set to "Monitored reset, falling edge with detection of shorts across contacts (In2-)".
- ▶ On the safety relay PNOZ s5 (K4), the time selector switch t[s] must be set to "0" and the factor selector switch n to "1".

Start/reset

The safety relay PNOZ s5 (K4) can be started by pressing reset button S6 if:

- ▶ E-STOP pushbutton S5 has not been operated and
- ▶ Safety relay PNOZ s7 (K6) has de-energised and
- ▶ the feedback loop on contact expander module K5 is closed and
- ▶ Contactors KM1 and KM2 have de-energised.

Feedback loop

The positive-guided N/C contact on the safety relay PNOZ s7 (K6) and the positive-guided N/C contacts on contactors KM1 und KM2 are monitored in feedback loop S12-S34 of safety relay PNOZ s5 (K4).

Safety assessment

- ▶ The safety relays K4, K5, K6 and the contactors KM1 and KM2 must be installed in a single mounting area (control cabinet) in order to exclude a short across the output.
- ▶ Earth faults and shorts between contacts in the input circuit are detected.
- ▶ A fault on the device does not lead to the loss of the safety function.
- ▶ The safety relays PNOZ s5 (K4), PNOZ s7 (K5) and PNOZ s7 (K6) can be started when the input circuit at K4 is closed first, followed by reset button S6. This avoids an unwanted reset before the input circuit is closed or as a result of the reset button being overridden.

- ▶ If the position of the operating mode selector switch (mode) or the rotary switch for the time setting is changed during operation, an error message will be triggered; the safety contacts on K4 open. This fault condition can only be rectified by switching the supply voltage on the safety relay PNOZ s5 (K4) off and then on again.

Pilz products

Number	Designation	Order number
1	PNOZ s5	750 105
2	PNOZ s7	750 107
1	PI Testop Set1.1	400 410

Emergency Stop Applications

PL e of EN ISO 13849-1, SIL 3 of EN 62061

PNOZ s5 - Combined with two PNOZ s7

Safety-related characteristics in accordance with EN ISO 13849-1

Prerequisites:

- ▶ Common cause failure (CCF): Requirements are considered to be met (must be tested on implementation)
- ▶ Mission time: 20 years
- ▶ Operating interval (electromechanical components):
 - Sensor: One operation per week
 - Actuator: One operation per week
- ▶ Characteristic data of contactors KM1/KM2: B10d: 2,000,000

Safety-related characteristics in accordance with EN 62061

Prerequisites:

- ▶ Common cause failure (CCF): $\beta = 2 \%$ (must be tested on implementation)
- ▶ Proof test interval: 20 years
- ▶ Operating interval (electromechanical components):
 - Sensor: One operation per week
 - Actuator: One operation per week
- ▶ Characteristic data of contactors KM1/KM2: B10d: 2,000,000
Dangerous failure rate: 65%

Classification in accordance with EN 954-1

Depending on the application area and its respective regulations, this connection example is suitable for applications up to Category 4 of EN 954-1.

EN ISO 13849-1		Performance Level	Safety-related parts of the control system
Safety function:	Machine shut down via E-STOP	PL e	Sensor (PITestop S5) Logic (PNOZ s5) Logic (PNOZ s7) Logic (PNOZ s7) Actuator (contactors KM1, KM2)

Please note the further requirements of EN ISO 13849-1, e.g. requirements for avoiding systematic faults.

EN 62061		Safety Integrity Level	Subsystems
Safety-related control function (SRCF):	Machine shut down via E-STOP	SIL 3	Sensor (PITestop S5) Logic (PNOZ s5) Logic (PNOZ s7) Logic (PNOZ s7) Actuator (contactors KM1, KM2)

Please note the further requirements of EN 62061, e.g. requirements for systematic safety integrity.

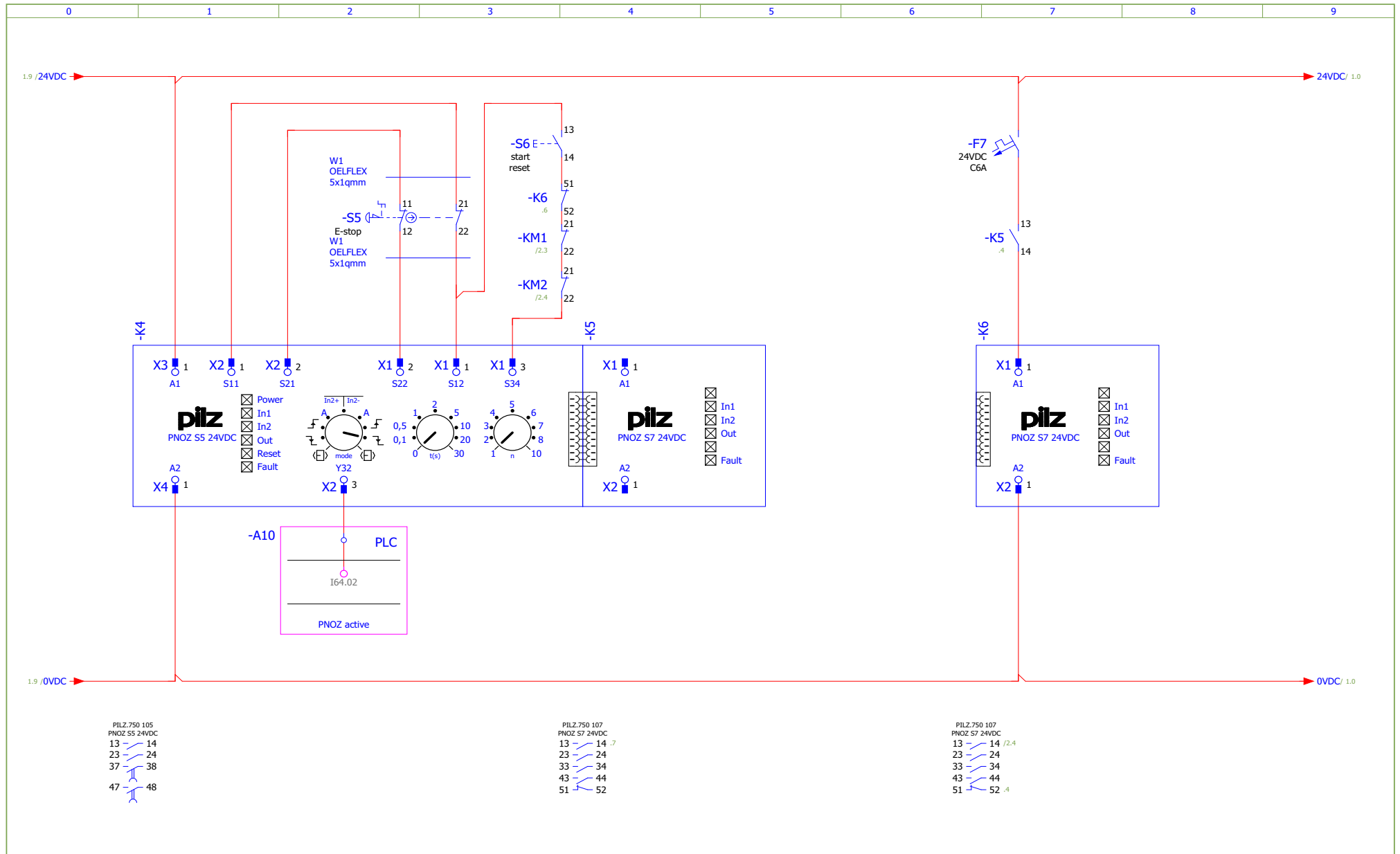

2.1

Revision	15.01.2009	Date	07.12.2005	EN ISO 13849-1:2006	PL e	Pilz GmbH & Co.KG Felix-Wankel-Str.2 73760 Ostfildern	Emergency stop, extension contact by two PNOZ s7 and monitored start	Mounting place + PNOZs5_3
Name	RDS	Name	WED	EN 62061:2005	SIL 3		Page: 1 / 2	
		Dep.	CS					

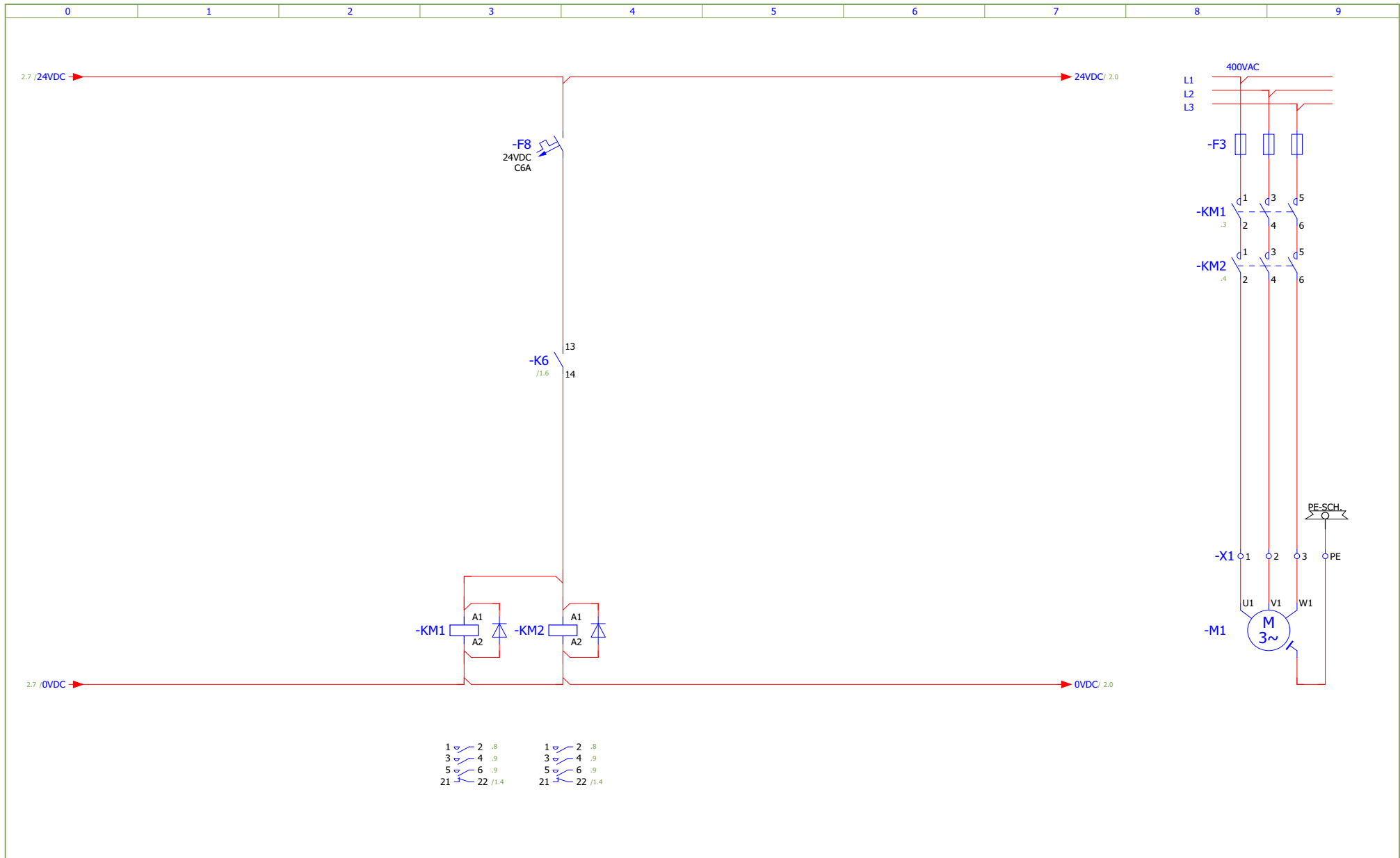

2.1

Revision	15.01.2009	Date	07.12.2005	EN ISO 13849-1:2006	PL e	 Pilz GmbH & Co.KG Felix-Wankel-Str.2 73760 Ostfildern	Emergency stop, extension contact by two PNOZ s7 and monitored start	Mounting place	+ PNOZs5_3
Name	RDS	Name	RDS	EN 62061:2005	SIL 3			Page:	2 / 2
		Dep.	CS						

PL e of EN ISO 13849-1, SIL 3 of EN 62061

PNOZ s7 - Combined with PNOZ s4

Features

- ▶ Dual-channel operation with detection of shorts across contacts
- ▶ Monitored reset with falling edge
- ▶ Contact expansion through PNOZ s7 (contact expander module) and positive-guided contactors
- ▶ Feedback loop to monitor contact expansion

Description

E-STOP function

When the E-STOP pushbutton S3 is operated, the input circuit on the safety relay PNOZ s4 (K4) is interrupted, the safety contacts on K4 open. As a result the input circuit on the contact expander module PNOZ s7 (K5) is interrupted, the safety contacts on K5 open. Contactors KM1 and KM2 de-energise.

Settings on the unit

- ▶ The connector between the safety relays PNOZ s4 (K4) and PNOZ s7 (K5) must be connected.
- ▶ The operating mode selector switch (mode) on the safety relay PNOZ s4 must be set to "Monitored reset, falling edge with detection of shorts across contacts (In2-)".

Start/reset

The safety relay PNOZ s4 (K4) can be started by pressing reset button S4 if:

- ▶ E-STOP pushbutton S3 has not been operated and
- ▶ The safety contacts on the contact expander module PNOZ s7 (K5) are open
- ▶ Contactors KM1 and KM2 have de-energised and
- ▶ The feedback loop on the contact expander module PNOZ s7 (K5) is closed.

Feedback loop

The positive-guided N/C contacts on contactors KM1 and KM2 are monitored in feedback loop S12-S34 of safety relay PNOZ s4 (K4).
The feedback loop on the safety relay PNOZ s4 (K4) is connected to the feedback loop on the contact expander module PNOZ s7 (K5).

Safety assessment

- ▶ The safety relays K4 and K5 and contactors KM1 and KM2 must be installed in a single mounting area (control cabinet) in order to exclude a short across the output.
- ▶ Earth faults and shorts between contacts in the input circuit are detected.
- ▶ A fault on the device does not lead to the loss of the safety function.
- ▶ The safety relays PNOZ s4 (K4) and PNOZ s7 (K5) can be started when the input circuit at K4 is closed first, followed by reset button S4. This avoids an

unwanted reset before the input circuit is closed or as a result of the reset button being overridden.

- ▶ If the position of the operating mode selector switch (mode) is changed during operation, an error message will be triggered; the safety contacts on K4 open. This fault condition can only be rectified by switching the supply voltage on the safety relay PNOZ s4 (K4) off and then on again.

Pilz products

Number	Designation	Order number
1	PNOZ s4	750 104
1	PNOZ s7	750 107
1	PITestop Set1.1	400 410

Emergency Stop Applications

PL e of EN ISO 13849-1, SIL 3 of EN 62061

PNOZ s7 - Combined with PNOZ s4

Safety-related characteristics in accordance with EN ISO 13849-1

Prerequisites:

- ▶ Common cause failure (CCF): Requirements are considered to be met (must be tested on implementation)
- ▶ Mission time: 20 years
- ▶ Operating interval (electromechanical components):
 - Sensor: One operation per week
 - Actuator: One operation per week
- ▶ Characteristic data of contactors KM1/KM2: B10d: 2,000,000

EN ISO 13849-1		Performance Level	Safety-related parts of the control system
Safety function:	Machine shut down via E-STOP	PL e	Sensor (PITestop S3) Logic (PNOZ s4) Logic (PNOZ s7) Actuator (contactors KM1, KM2)

Please note the further requirements of EN ISO 13849-1, e.g. requirements for avoiding systematic faults.

Safety-related characteristics in accordance with EN 62061

Prerequisites:

- ▶ Common cause failure (CCF): $\beta = 2 \%$ (must be tested on implementation)
- ▶ Proof test interval: 20 years
- ▶ Operating interval (electromechanical components):
 - Sensor: One operation per week
 - Actuator: One operation per week
- ▶ Characteristic data of contactors KM1/KM2: B10d: 2,000,000
Dangerous failure rate: 65%

EN 62061		Safety Integrity Level	Subsystems
Safety-related control function (SRCF):	Machine shut down via E-STOP	SIL 3	Sensor (PITestop S3) Logic (PNOZ s4) Logic (PNOZ s7) Actuator (contactors KM1, KM2)

Please note the further requirements of EN 62061, e.g. requirements for systematic safety integrity.

Classification in accordance with EN 954-1

Depending on the application area and its respective regulations, this connection example is suitable for applications up to Category 4 of EN 954-1.

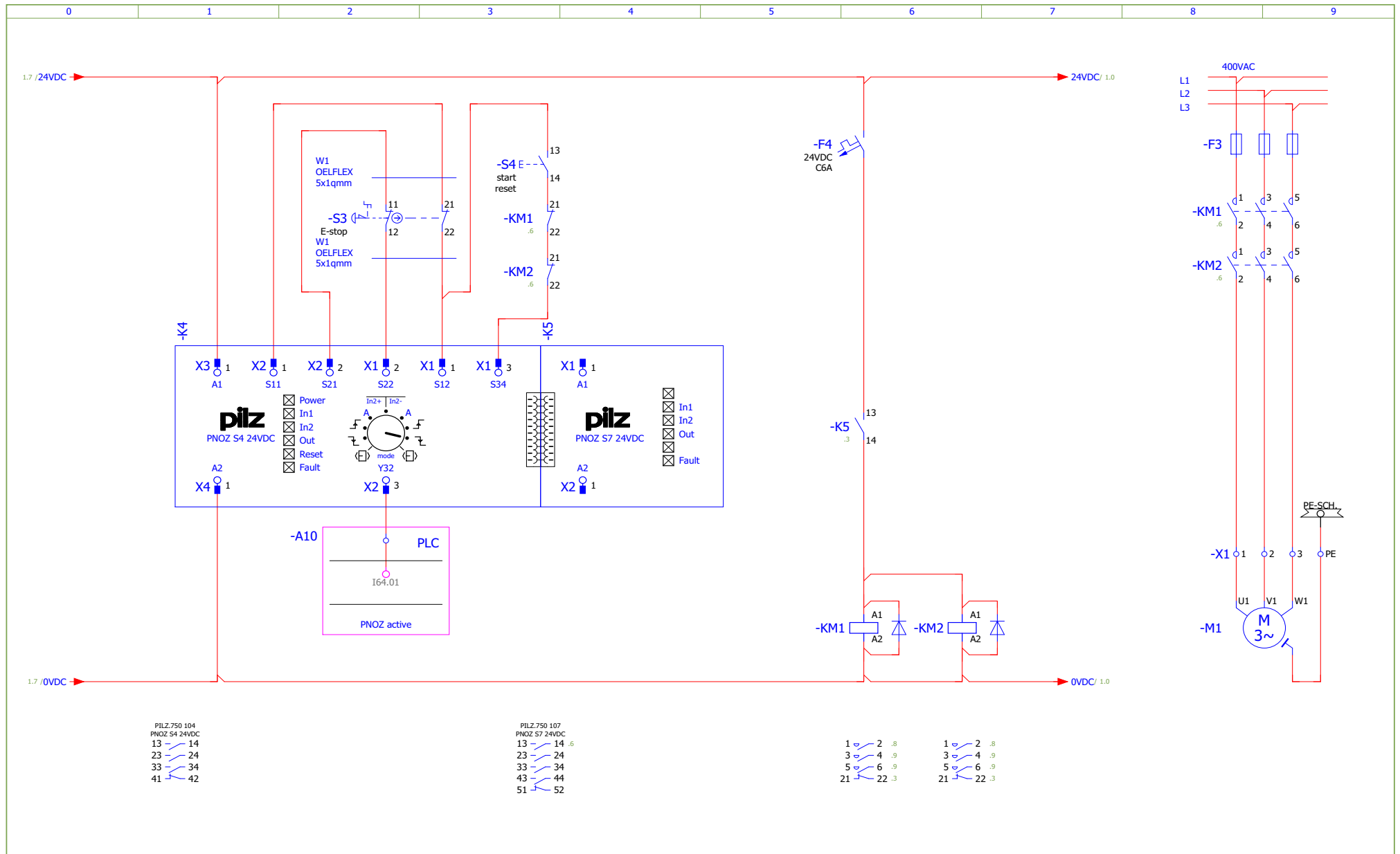

Revision	15.01.2009	Date	07.12.2005	EN ISO 13849-1:2006	PL e	Pilz GmbH & Co.KG Felix-Wankel-Str.2 73760 Ostfildern	Emergency stop, extension contact by PNOZ s7 and contactor, monitored start	Mounting place + PNOZs7_2
Name	RDS	Name	WED	EN 62061:2005	SIL 3			Page: 1 / 1
		Dep.	CS					

PL e of EN ISO 13849-1, SIL 3 of EN 62061

PNOZ s9 - Combined with PNOZ s4 - safe standstill of one drive

Features

- ▶ Dual-channel operation with detection of shorts across contacts
- ▶ Monitored reset with falling edge
- ▶ Safe standstill of one drive after E-STOP
- ▶ Contact expansion through positive-guided contactors
- ▶ Feedback loop to monitor contact expansion
- ▶ Stop category 1 in accordance with EN 60204-1

Description

E-STOP function

When the E-STOP pushbutton S9 is operated, both the drive and the supply to the drive are shut down after a delay time. When the E-STOP pushbutton S9 is operated, the input circuit on the safety relay PNOZ s4 (K11) is interrupted, safety contact 14 on K11 opens immediately and triggers a “fast stop” at the drive controller A1.

As a result the input circuit on safety relay PNOZ s9 (K12) is interrupted and the delay-on de-energisation safety contacts on K12 switch off contactors KM1 and KM2 after a delay. In this way, the drive controller A1 is isolated from the energy supply (mains) after a delay. The delay-on de-energisation time is set on the safety relay PNOZ s9 (K12).

Settings on the unit

- ▶ The connector between the safety relays PNOZ s4 (K11) and PNOZ s9 (K12) must be connected.
- ▶ The operating mode selector switch (mode) on the safety relay PNOZ s4 (K11) must be set to “Monitored reset, falling edge with detection of shorts across contacts (In2-)”.
- ▶ The operating mode selector switch (mode) on the safety relay PNOZ s9 (K12) must be set to “Delay-on de-energisation, not retriggerable”.
- ▶ The delay time on the safety relay PNOZ s9 (K12) is set using the time selector switch t[s] and the factor selector switch n.

Start/reset

The safety relay PNOZ s4 (K11) can be started by pressing reset button S10 if:

- ▶ E-STOP pushbutton S9 has not been operated and
- ▶ Contactors KM1 and KM2 have de-energised and
- ▶ The feedback loop on safety relay PNOZ s9 (K12) is closed.

Feedback loop

The positive-guided N/C contacts on contactors KM1 and KM2 are monitored in feedback loop S12-S34 of safety relay K11. The feedback loop on the safety relay PNOZ s4 (K11) is connected to the feedback loop on the contact expander module PNOZ s9 (K12).

Safety assessment

- ▶ The safety relays PNOZ s4 (K11) and PNOZ s9 (K12) and contactors KM1 and KM2 must be installed in a single mounting area (control cabinet) in order to exclude a short across the output.
- ▶ Earth faults and shorts between contacts in the input circuit are detected.
- ▶ A fault on the device does not lead to the loss of the safety function.
- ▶ The safety relays PNOZ s4 (K11) and PNOZ s9 (K12) can be started when the input circuit at K11 is closed first, followed by reset button S10. This avoids an unwanted reset before the input circuit is closed or as a result of the reset button being overridden.
- ▶ The delay time set for the safety relay PNOZ s9 (K12) must be longer than the maximum braking time on the drive regulator A1.
- ▶ The time delay must not be able to cause an additional hazard.
- ▶ If the position of the operating mode selector switch (mode) or the rotary switch for the time setting is changed during operation, an error message will be triggered; the safety contacts on K11 / K12 open. This fault condition can only be rectified by switching the supply voltage on the safety relay PNOZ s4 (K11) / PNOZ s9 (K12) off and then on again.

Pilz products

Number	Designation	Order number
1	PNOZ s4	750 104
1	PNOZ s9	750 109
1	PITestop Set1.1	400 410

Emergency Stop Applications

PL e of EN ISO 13849-1, SIL 3 of EN 62061

PNOZ s9 - Combined with PNOZ s4 - safe standstill of one drive

Safety-related characteristics in accordance with EN ISO 13849-1

Prerequisites:

- ▶ Common cause failure (CCF): Requirements are considered to be met (must be tested on implementation)
- ▶ Mission time: 20 years
- ▶ Operating interval (electromechanical components):
 - Sensor: One operation per week
 - Actuator: One operation per week
- ▶ Characteristic data of contactors KM1/KM2: B10d: 2,000,000

EN ISO 13849-1		Performance Level	Safety-related parts of the control system
Safety function:	Machine shut down via E-STOP	PL e	Sensor (PITestop S9) Logic (PNOZ s4) Logic (PNOZ s9) Actuator (contactors KM1, KM2)

Please note the further requirements of EN ISO 13849-1, e.g. requirements for avoiding systematic faults.

Safety-related characteristics in accordance with EN 62061

Prerequisites:

- ▶ Common cause failure (CCF): $\beta = 2 \%$ (must be tested on implementation)
- ▶ Proof test interval: 20 years
- ▶ Operating interval (electromechanical components):
 - Sensor: One operation per week
 - Actuator: One operation per week
- ▶ Characteristic data of contactors KM1/KM2: B10d: 2,000,000
Dangerous failure rate: 65%

EN 62061		Safety Integrity Level	Subsystems
Safety-related control function (SRCF):	Machine shut down via E-STOP	SIL 3	Sensor (PITestop S9) Logic (PNOZ s4) Logic (PNOZ s9) Actuator (contactors KM1, KM2)

Please note the further requirements of EN 62061, e.g. requirements for systematic safety integrity.

Classification in accordance with EN 954-1

Depending on the application area and its respective regulations, this connection example is suitable for applications up to Category 4 of EN 954-1.

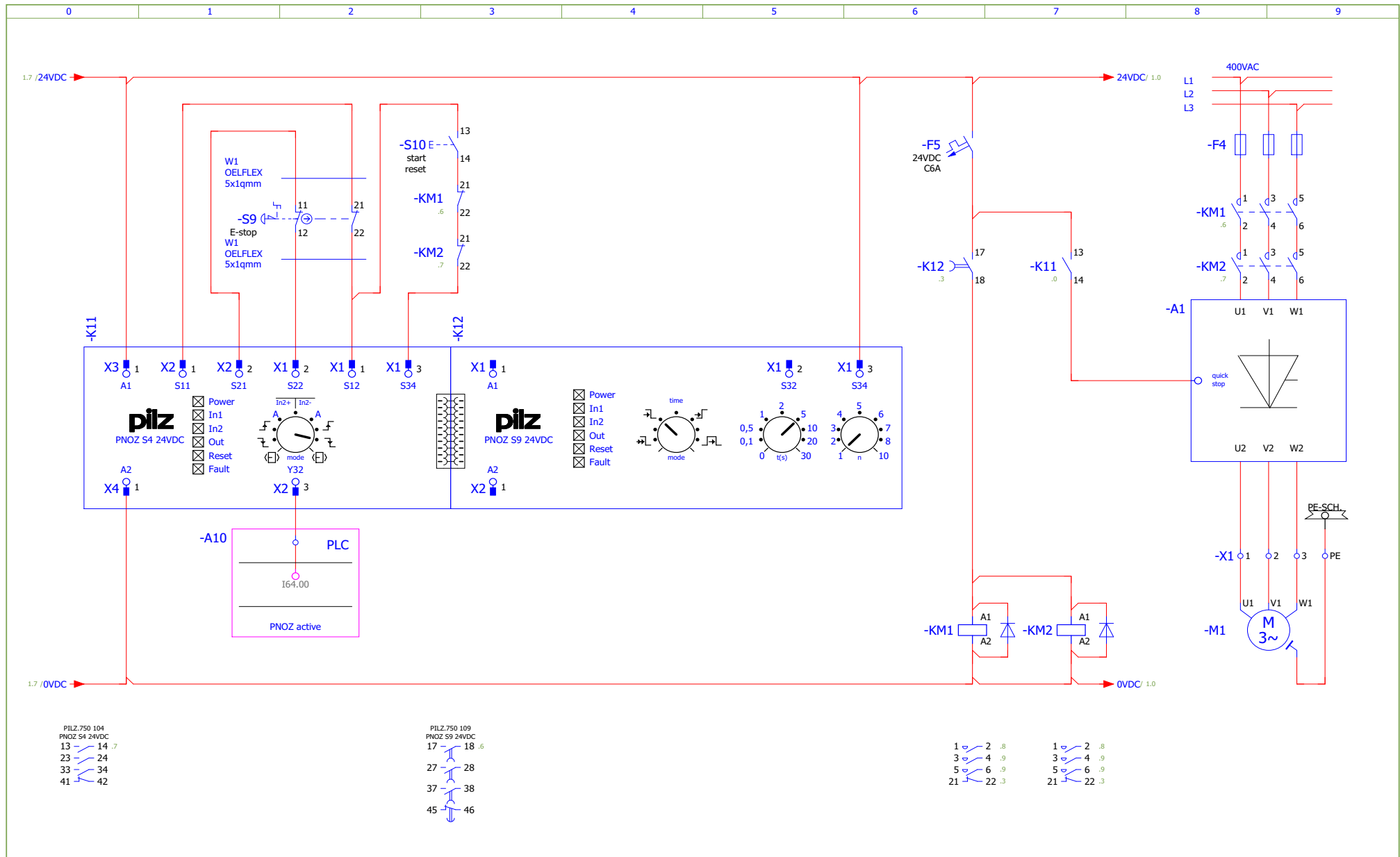

2.1

Revision	15.01.2009	Date	07.12.2005	EN ISO 13849-1:2006	PL e	Pilz GmbH & Co. KG Felix-Wankel-Str.2 73760 Ostfildern	Safe stopping of a drive by emergency stop	Mounting place + PNOZs9_4
Name	RDS	Name	WED	EN 62061:2005	SIL 3			Page: 1 / 1
		Dep.	CS					

PL e of EN ISO 13849-1, SIL 3 of EN 62061

PNOZ s10 - Combined with PNOZ s4

Features

- ▶ Dual-channel operation with detection of shorts across contacts
- ▶ Monitored reset with falling edge
- ▶ Contact expansion through PNOZ s10 (contact expander module)
- ▶ Feedback loop to monitor contact expansion

Description

E-STOP function

When the E-STOP pushbutton S1 is operated, the input circuit on the safety relay PNOZ s4 (K1) is interrupted, the safety contacts on K1 open. As a result the input circuit on the contact expander module PNOZ s10 (K2) is interrupted, the safety contacts on K2 open.

Settings on the unit

- ▶ The connector between the safety relays PNOZ s4 (K1) and PNOZ s10 (K2) must be connected.
- ▶ The operating mode selector switch (mode) on the safety relay PNOZ s4 must be set to “Monitored reset, falling edge with detection of shorts across contacts (In2-)”.

Start/reset

The safety relay PNOZ s4 (K1) can be started by pressing reset button S2 if:

- ▶ E-STOP pushbutton S1 has not been operated and
- ▶ Contactors KM1 and KM2 have de-energised and
- ▶ the feedback loop on the contact expander module PNOZ s10 (K2) is closed.

Feedback loop

The positive-guided N/C contacts on contactors KM1 and KM2 are monitored in feedback loop S12-S34 of safety relay PNOZ s4 (K1).

The feedback loop on the safety relay PNOZ s4 (K1) is connected to the feedback loop on the contact expander module PNOZ s10 (K2).

Safety assessment

- ▶ The safety relays PNOZ s4 (K1) and PNOZ s9 (K2) and the contactors KM1 and KM2 must be installed in a single mounting area (control cabinet) in order to exclude a short across the output.
- ▶ Earth faults and shorts between contacts in the input circuit are detected.
- ▶ A fault on the device does not lead to the loss of the safety function.
- ▶ The safety relays PNOZ s4 (K1) and PNOZ s10 (K2) can be started when the input circuit at K1 is closed first, followed by the reset button S2. This avoids an unwanted reset before the input circuit is closed or as a result of the reset button

- ▶ being overridden.
- ▶ If the position of the operating mode selector switch (mode) is changed during operation, an error message will be triggered; the safety contacts on K1 open. This fault condition can only be rectified by switching the supply voltage on the safety relay PNOZ s4 (K1) off and then on again.

Pilz products

Number	Designation	Order number
1	PNOZ s4	750 104
1	PNOZ s10	750 110
1	PITestop Set1.1	400 410

Emergency Stop Applications

PL e of EN ISO 13849-1, SIL 3 of EN 62061

PNOZ s10 - Combined with PNOZ s4

Safety-related characteristics in accordance with EN ISO 13849-1

Prerequisites:

- ▶ Common cause failure (CCF): Requirements are considered to be met (must be tested on implementation)
- ▶ Mission time: 20 years
- ▶ Operating interval (electromechanical components):
 - Sensor: One operation per week
 - Actuator: One operation per week
- ▶ Characteristic data of contactors KM1/KM2: B10d: 2,000,000

EN ISO 13849-1		Performance Level	Safety-related parts of the control system
Safety function:	Machine shut down via E-STOP	PL e	Sensor (PITestop S1) Logic (PNOZ s4) Logic (PNOZ s10) Actuator (contactors KM1, KM2)

Please note the further requirements of EN ISO 13849-1, e.g. requirements for avoiding systematic faults.

Safety-related characteristics in accordance with EN 62061

Prerequisites:

- ▶ Common cause failure (CCF): $\beta = 2 \%$ (must be tested on implementation)
- ▶ Proof test interval: 20 years
- ▶ Operating interval (electromechanical components):
 - Sensor: One operation per week
 - Actuator: One operation per week
- ▶ Characteristic data of contactors KM1/KM2: B10d: 2,000,000
Dangerous failure rate: 65%

EN 62061		Safety Integrity Level	Subsystems
Safety-related control function (SRCF):	Machine shut down via E-STOP	SIL 3	Sensor (PITestop S1) Logic (PNOZ s4) Logic (PNOZ s10) Actuator (contactors KM1, KM2)

Please note the further requirements of EN 62061, e.g. requirements for systematic safety integrity.

Classification in accordance with EN 954-1

Depending on the application area and its respective regulations, this connection example is suitable for applications up to Category 4 of EN 954-1.

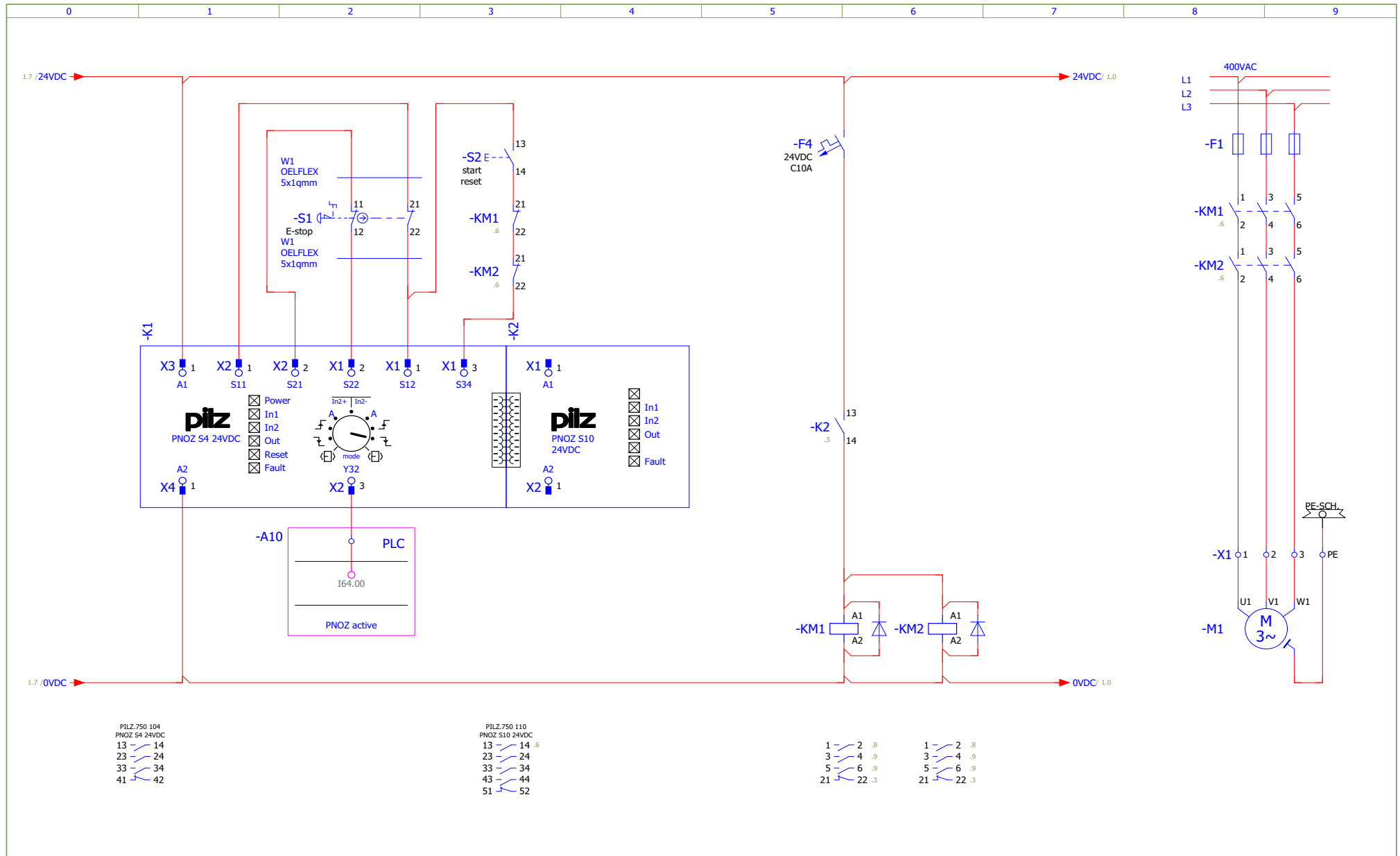

PILZ.750 104
PNOZ S4 24VDC
13 - 14
23 - 24
33 - 34
41 - 42

PILZ.750 110
PNOZ S10 24VDC
13 - 14 .6
23 - 24
33 - 34
43 - 44
51 - 52

1 - 2 .8
3 - 4 .9
5 - 6 .9
21 - 22 .3

1 - 2 .8
3 - 4 .9
5 - 6 .9
21 - 22 .3

Revision	15.01.2009	Date	07.12.2005	EN ISO 13849-1:2006	PL e	Pilz GmbH & Co.KG Felix-Wankel-Str.2 73760 Ostfildern	Emergency stop, extension contact by PNOZ s10 and monitored start	Mounting place + PNOZs10_1
Name	RDS	Name	WED	EN 62061:2005	SIL 3			Page: 1 / 1
		Dep.	CS					

Contents		Page
<hr/>		
Safety gate applications		
PNOZ s3	- Dual-channel operation, Safety switch PSEN cs2.1p	PL e of EN ISO 13849-1, SIL 3 of EN 62061 2.2-2
PNOZ s4	- Safety switch PSEN me2/2AS	PL e of EN ISO 13849-1 SIL 3 of EN 62061 2.2-5

PL e of EN ISO 13849-1, SIL 3 of EN 62061

PNOZ s3 – Dual-channel operation, Safety switch PSEN cs2.1p

Features

- ▶ Dual-channel operation with detection of shorts across contacts via safety switch
- ▶ Monitored reset with falling edge
- ▶ Contact expansion through positive-guided contactors
- ▶ Feedback loop to monitor contact expansion

Description

Safety gate function

The opening and closing of a safety gate is signalled to the safety relay PNOZ s3 (K2) via the semiconductor outputs on the safety switch PSEN cs2.1p (S3). The semiconductor outputs on safety switch S3 are opened as soon as the safety gate is opened. As a result the input circuit on the safety relay PNOZ s3 (K2) is interrupted and the safety contacts on the PNOZ s3 (K2) open. Contactors K3 and K4 de-energise.

Settings on the unit

- ▶ The terminator on the PNOZ s3 must be connected.
- ▶ The operating mode selector switch (mode) on the safety relay PNOZ s3 must be set to “Monitored reset, falling edge without detection of shorts across contacts (In2+)“.

Start/reset

The safety relay PNOZ s3 (K2) can be started by pressing reset button S4 if:

- ▶ The safety gate is closed and
- ▶ The semiconductor outputs on the safety switch S3 are closed and
- ▶ Contactors K3 and K4 have de-energised.

Feedback loop

The positive-guided N/C contacts on contactors K3 and K4 are monitored in the feedback loop S12-S34 of the safety relay K2.

Safety assessment

- ▶ The safety relay K2 and contactors K3 and K4 must be installed in a single mounting area (control cabinet) in order to exclude a short across the output.
- ▶ Earth faults and shorts between contacts in the input circuit are detected through the safety switch S3.
- ▶ A fault on the device does not lead to the loss of the safety function.
- ▶ The safety relay PNOZ s3 (K2) can be started when the input circuit at K2 is closed first, followed by reset button S4. This avoids an unwanted reset before the input circuit is closed or as a result of the reset button being overridden.
- ▶ Increased protection against manipulation is required for hazardous machinery such as presses. In this case we recommend using two safety switches per safety gate.

- ▶ If the position of the operating mode selector switch (mode) is changed during operation, an error message will be triggered; the safety contacts on K2 open. This fault condition can only be rectified by switching the supply voltage on the safety relay K2 off and then on again.

Pilz products

Number	Designation	Order number
1	PNOZ s3	750 103
1	PSEN cs2.1p	540 100

PL e of EN ISO 13849-1, SIL 3 of EN 62061

PNOZ s3 – Dual-channel operation, Safety switch PSEN cs2.1p

Safety-related characteristics in accordance with EN ISO 13849-1

Prerequisites:

- ▶ Common cause failure (CCF): Requirements are considered to be met (must be tested on implementation)
- ▶ Mission time: 20 years
- ▶ Operating interval (electromechanical components):
 - Sensor: Two operations per hour
 - Actuator: Two operations per hour
- ▶ Characteristic data of contactors K3/K4: B10d: 2,000,000

Safety-related characteristics in accordance with EN 62061

Prerequisites:

- ▶ Common cause failure (CCF): $\beta = 2 \%$ (must be tested on implementation)
- ▶ Proof test interval: 20 years
- ▶ Operating interval (electromechanical components):
 - Sensor: Two operations per hour
 - Actuator: Two operations per hour
- ▶ Characteristic data of contactors K3/K4: B10d: 2,000,000
Dangerous failure rate: 65%

Classification in accordance with EN 954-1

Depending on the application area and its respective regulations, this connection example is suitable for applications up to Category 4 of EN 954-1.

EN ISO 13849-1		Performance Level	Safety-related parts of the control system
Safety function:	Machine shut down when a safety gate is opened	PL e	Sensor (PSEN cs) Logic (PNOZ s3) Actuator (contactors K3, K4)

Please note the further requirements of EN ISO 13849-1, e.g. requirements for avoiding systematic faults.

EN 62061		Safety Integrity Level	Subsystems
Safety-related control function (SRCF):	Machine shut down when a safety gate is opened	SIL 3	Sensor (PSEN cs) Logic (PNOZ s3) Actuator (contactors K3, K4)

Please note the further requirements of EN 62061, e.g. requirements for systematic safety integrity.

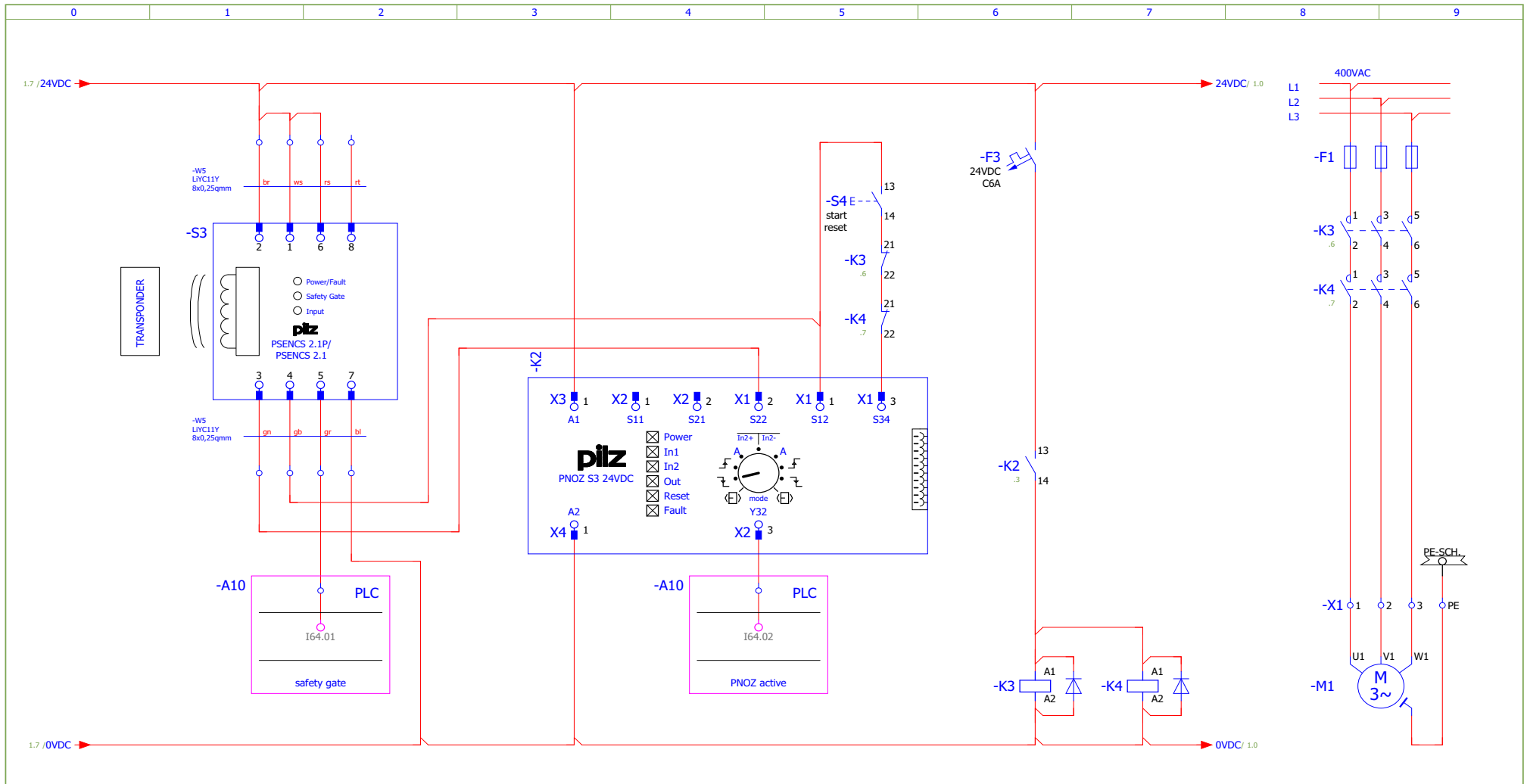

Revision	15.01.2009	Date	07.12.2005	EN ISO 13849-1:2006	PL e	Pilz GmbH & Co.KG Felix-Wankel-Str.2 73760 Ostfildern	Safety gate with PSEN cs2.1p and monitored start of PNOZ s3	Mounting place	+ PNOZs3_2 Page: 1 / 1
Name	RDS	Name	WED	EN 62061:2005	SIL 3				
		Dep.	CS						

PL e of EN ISO 13849-1, SIL 3 of EN 62061

PNOZ s4 - Safety switch PSEN me2/2AS

Features

- ▶ Dual-channel operation with detection of shorts across contacts
- ▶ Safety gate switch with separate actuator
- ▶ Monitored reset with falling edge
- ▶ Contact expansion through positive-guided contactors
- ▶ Feedback loop to monitor contact expansion

Description

Safety gate function

The opening and closing of a safety gate is signalled to the safety relay PNOZ s4 (K9) via the contacts on the two safety switches PSEN me2/2AS (S11, S12).

The contacts on safety switches S11, S12 are opened as soon as the safety gate is opened. As a result the input circuit on the safety relay PNOZ s4 (K9) is interrupted and the safety contacts on K9 open. Contactors K10 and K11 de-energise.

Settings on the unit

- ▶ The terminator on the PNOZ s4 must be connected.
- ▶ The operating mode selector switch (mode) on the safety relay PNOZ s4 must be set to "Monitored reset, falling edge with detection of shorts across contacts (In2-)".

Start/reset

The safety relay PNOZ s4 (K9) can be started by pressing reset button S13 if:

- ▶ The safety gate is closed and
- ▶ The contacts on safety switches S11 and S12 are closed and
- ▶ Contactors K10 and K11 have de-energised.

Feedback loop

The positive-guided N/C contacts on contactors K10 and K11 are monitored in feedback loop S12-S34 of safety relay K9.

Safety assessment

- ▶ The safety relay PNOZ s4 (K9) and contactors K10 and K11 must be installed in a single mounting area (control cabinet) in order to exclude a short across the output.
- ▶ Earth faults and shorts between contacts in the input circuit are detected.
- ▶ A fault on the device does not lead to the loss of the safety function.
- ▶ If the position of the operating mode selector switch (mode) is changed during operation, an error message will be triggered; the safety contacts on K9 open. This fault condition can only be rectified by switching the supply voltage on the safety relay K9 off and then on again.

Pilz products

Number	Designation	Order number
1	PNOZ s4	750 104
2	PSEN me2/2AS	570 200

PL e of EN ISO 13849-1, SIL 3 of EN 62061

PNOZ s4 - Safety switch PSEN me2/2AS

Safety-related characteristics in accordance with EN ISO 13849-1

Prerequisites:

- ▶ Common cause failure (CCF): Requirements are considered to be met (must be tested on implementation)
- ▶ Mission time: 20 years
- ▶ Operating interval (electromechanical components):
 - Sensor: Two operations per hour
 - Actuator: Two operations per hour
- ▶ Characteristic data of contactors K10/K11: B10d: 2,000,000

Safety-related characteristics in accordance with EN 62061

Prerequisites:

- ▶ Common cause failure (CCF): $\beta = 2 \%$ (must be tested on implementation)
- ▶ Proof test interval: 20 years
- ▶ Operating interval (electromechanical components):
 - Sensor: Two operations per hour
 - Actuator: Two operations per hour
- ▶ Characteristic data of contactors K10/K11: B10d: 2,000,000
Dangerous failure rate: 65%

Classification in accordance with EN 954-1

Depending on the application area and its respective regulations, this connection example is suitable for applications up to Category 4 of EN 954-1.

EN ISO 13849-1		Performance Level	Safety-related parts of the control system
Safety function:	Machine shut down when a safety gate is opened	PL e	Sensor (PSEN me S11, S12) Logic (PNOZ s4) Actuator (contactors K10, K11)

Please note the further requirements of EN ISO 13849-1, e.g. requirements for avoiding systematic faults.

EN 62061		Safety Integrity Level	Subsystems
Safety-related control function (SRCF):	Machine shut down when a safety gate is opened	SIL 3	Sensor (PSEN me S11, S12) Logic (PNOZ s4) Actuator (contactors K10, K11)

Please note the further requirements of EN 62061, e.g. requirements for systematic safety integrity.

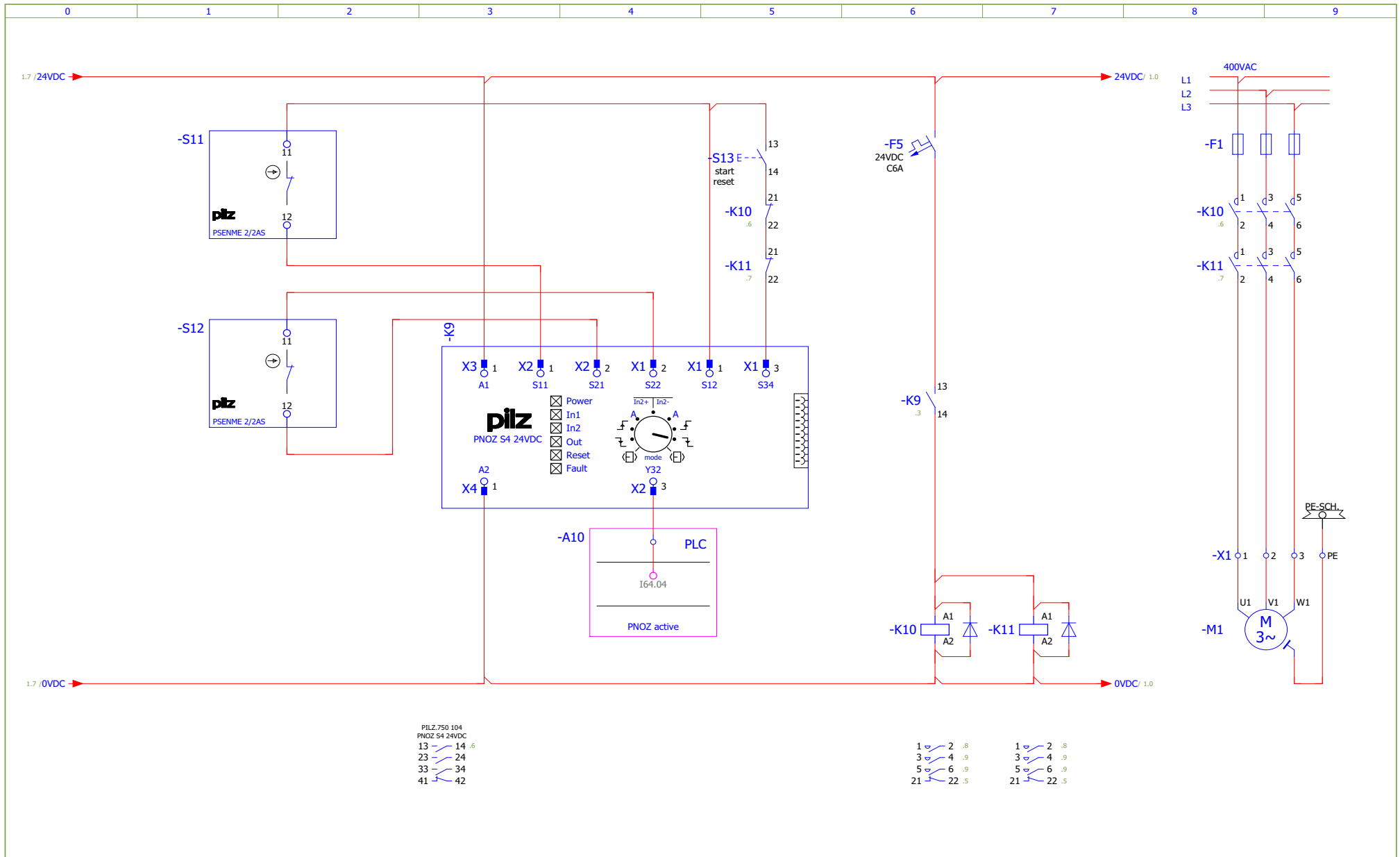

Revision	15.01.2009	Date	07.12.2005	EN ISO 13849-1:2006	PL e	Pilz GmbH & Co.KG Felix-Wankel-Str.2 73760 Ostfildern	Safety gate with two PSEN me2/2AS and monitored start of PNOZ s4	Mounting place + PNOZs4_5
Name	RDS	Name	WED	EN 62061:2005	SIL 3			Page: 1 / 1
		Dep.	CS					

Contents		Page
ESPE applications		
PNOZ s4	- PSEN op4H light curtain	PL e of EN ISO 13849-1, SIL 3 of EN 62061
		2.3-2

PL e of EN ISO 13849-1, SIL 3 of EN 62061

PNOZ s4 - PSEN op4H light curtain

Features

- ▶ Dual-channel operation with detection of shorts across contacts via light curtain
- ▶ Monitored reset with falling edge
- ▶ Light curtain with semiconductor output
- ▶ Contact expansion through positive-guided contactors
- ▶ Feedback loop to monitor contact expansion

Description

Light curtain function

The interruption of light curtain PSEN op4H (B1/B2) is signalled to the safety relay PNOZ s4 (K2) via the two semiconductor outputs on receiver B2.

The semiconductor outputs on the safety light curtain's receiver B2 are opened as soon as the light curtain is interrupted. As a result the input circuit on the safety relay PNOZ s4 (K2) is interrupted and the safety contacts open. Contactors K3 and K4 de-energise.

The top and bottom DIP switches on the receiver B2 must be set at the same position. For the light curtain to reset automatically, number 4 on both DIP switches must be switched to ON.

Settings on the unit

- ▶ The terminator on the PNOZ s4 must be connected.
- ▶ The operating mode selector switch (mode) on the safety relay PNOZ s4 must be set to "Monitored reset, falling edge without detection of shorts across contacts (In2+)".

Start/reset

The safety relay PNOZ s4 (K2) can be started by pressing reset button S3 if:

- ▶ The light curtain is not interrupted and
- ▶ The semiconductor outputs on safety light curtain B1/B2 are closed and
- ▶ Contactors K3 and K4 have de-energised.

Feedback loop

The positive-guided N/C contacts on contactors K3 and K4 are monitored in feedback loop S12-S34 of the safety relay.

Safety assessment

- ▶ The safety relay PNOZ s4 (K2) and contactors K3, K4 must be installed in a single mounting area (control cabinet) in order to exclude a short across the output.
- ▶ Earth faults and shorts between contacts in the input circuit are detected via the light curtain.
- ▶ A fault on the device does not lead to the loss of the safety function.
- ▶ A single fault in the light curtain is detected.

- ▶ The safety relay PNOZ s4 (K2) can be started when the input circuit at K2 is closed first, followed by reset button S3. This avoids an unwanted reset before the input circuit is closed or as a result of the reset button being overridden.
- ▶ If the position of the operating mode selector switch (mode) is changed during operation, an error message will be triggered; the safety contacts on K2 open. This fault condition can only be rectified by switching the supply voltage on the safety relay K2 off and then on again.

Pilz products

Number	Designation	Order number
1	PNOZ s4	750 104
1	PSEN op4H-30-150	630 159

PL e of EN ISO 13849-1, SIL 3 of EN 62061

PNOZ s4 - PSEN op4H light curtain

Safety-related characteristics in accordance with EN ISO 13849-1

Prerequisites:

- ▶ Common cause failure (CCF): Requirements are considered to be met (must be tested on implementation)
- ▶ Mission time: 20 years
- ▶ Operating interval (electromechanical components):
 - Sensor: Two operations per hour
 - Actuator: Two operations per hour
- ▶ Characteristic data of contactors K3/K4: B10d: 2,000,000

EN ISO 13849-1		Performance Level	Safety-related parts of the control system
Safety function:	Machine shut down when the safety light curtain is interrupted	PL e	Sensor (PSEN op4H) Logic (PNOZ s4) Actuator (contactors K3, K4)

Please note the further requirements of EN ISO 13849-1, e.g. requirements for avoiding systematic faults.

Safety-related characteristics in accordance with EN 62061

Prerequisites:

- ▶ Common cause failure (CCF): $\beta = 2 \%$ (must be tested on implementation)
- ▶ Proof test interval: 20 years
- ▶ Operating interval (electromechanical components):
 - Sensor: Two operations per hour
 - Actuator: Two operations per hour
- ▶ Characteristic data of contactors K3/K4: B10d: 2,000,000
Dangerous failure rate: 65%

EN 62061		Safety Integrity Level	Subsystems
Safety-related control function (SRCF):	Machine shut down when the safety light curtain is interrupted	SIL 3	Sensor (PSEN op4H) Logic (PNOZ s4) Actuator (contactors K3, K4)

Please note the further requirements of EN 62061, e.g. requirements for systematic safety integrity.

Classification in accordance with EN 954-1

Depending on the application area and its respective regulations, this connection example is suitable for applications up to Category 4 of EN 954-1.

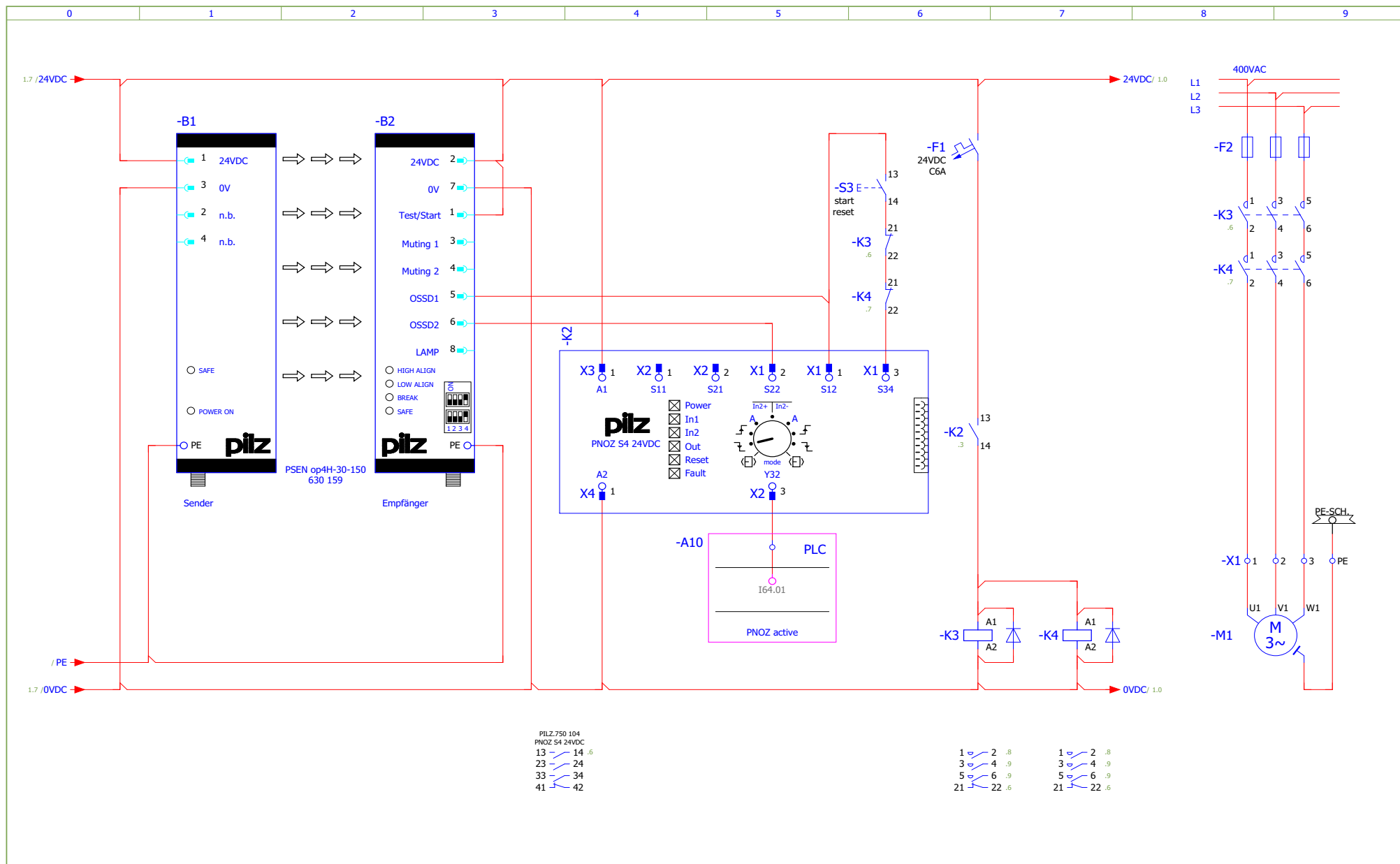

Revision	15.01.2009	Date	07.12.2005	EN ISO 13849-1:2006	PL e	Pilz GmbH & Co.KG Felix-Wankel-Str.2 73760 Ostfildern	ESPE PSEN op4H with monitored start of PNOZ s4	Mounting place
Name	RDS	Name	WED	EN 62061:2005	SIL 3			+ PNOZs4_2
		Dep.	CS					Page: 1 / 1

Contents		Page
Further applications		
PNOZ s6	- Requirements in accordance with EN 574 Type IIIC, Contact expansion through contactors	PL e of EN ISO 13849-1, SIL 3 of EN 62061 2.4-2
PNOZ s6	- Requirements in accordance with EN 574 Type IIIC, Contact expansion through PNOZ s10	PL e of EN ISO 13849-1, SIL 3 of EN 62061 2.4-6
PNOZ s6.1	- Requirements in accordance with EN 574 Type IIIA	PL b of EN ISO 13849-1 2.4-10

PL e of EN ISO 13849-1, SIL 3 of EN 62061

PNOZ s6 - Requirements in accordance with EN 574 Type IIIC, contact expansion through contactors

Features

- ▶ Dual-channel operation with detection of shorts across contacts
- ▶ Simultaneity monitoring
- ▶ Contact expansion through positive-guided contactors
- ▶ Feedback loop to monitor contact expansion
- ▶ Requirements in accordance with EN 574 Type IIIC

Description

Function

The two-hand control device PNOZ s6 (K1) is activated by operating both pushbuttons S1 and S2 simultaneously (simultaneity max. 500 ms), the safety contacts on K1 close. Contactors KM1 and KM2 energise. Releasing one or both pushbuttons S1 / S2 will interrupt the input circuit on the two-hand control device K1, the safety contacts at K1 open. Contactors KM1 and KM2 de-energise. The safety contacts on the two-hand control device PNOZ s6 (K1) will not reclose until both pushbuttons S1 and S2 have been released and then re-operated simultaneously.

Settings on the unit

The terminator on the PNOZ s6 must be connected.

Start/reset

The two-hand control device PNOZ s6 can be started by operating pushbuttons S1 and S2 simultaneously when contactors KM1 and KM2 have de-energised.

Feedback loop

The positive-guided N/C contacts on contactors KM1 and KM2 are monitored in feedback loop S12-S34 of the two-hand control device.

Safety assessment

- ▶ The two-hand control device PNOZ s6 (K1) and contactors KM1 and KM2 must be installed in a single mounting area (control cabinet) in order to exclude a short across the output.
- ▶ Earth faults and shorts between contacts in the input circuit are detected.
- ▶ A fault on the device does not lead to the loss of the safety function.
- ▶ The distance of both pushbuttons S1 and S2 from the nearest danger zone must be large enough that if one of the pushbuttons is released, the dangerous movement is interrupted before the operator can reach the danger zone or before the operator can reach into the danger zone (see EN 999 „The positioning of protective equipment in respect of approach speeds of parts of the human body“).

Pilz products

Number	Designation	Order number
1	PNOZ s6	750 106

PL e of EN ISO 13849-1, SIL 3 of EN 62061

PNOZ s6 - Requirements in accordance with EN 574 Type IIIC, contact expansion through contactors

Safety-related characteristics in accordance with EN ISO 13849-1

Prerequisites:

- ▶ Common cause failure (CCF):
Requirements are considered to be met (must be tested on implementation)
- ▶ Mission time: 20 years
- ▶ Operating interval (electromechanical components):
 - Sensor: 60 operations per hour
 - Actuator: 60 operations per hour
- ▶ Characteristic data of pushbuttons S1/S2:
B10d: 20.000.000
- ▶ Characteristic data of contactors KM1/KM2:
B10d: 2,000,000 (note oversizing)

EN ISO 13849-1		Performance Level	Safety-related parts of the control system
Safety function:	Pushbuttons are operated simultaneously with both hands, to keep the operator away from the danger zone. Hazardous movement is stopped by releasing one or both pushbuttons; reactivation is possible once both pushbuttons are released. Further requirements relevant to two-hand circuits in accordance with EN 574 Type IIIC.	PL e	Sensor (pushbutton S1/S2) Logic (PNOZ s6) Actuator (contactor KM1, KM2)

Please note the further requirements of EN ISO 13849-1, e.g. requirements for avoiding systematic faults.

PL e of EN ISO 13849-1, SIL 3 of EN 62061

PNOZ s6 - Requirements in accordance with EN 574 Type IIIC, contact expansion through contactors

Safety-related characteristics in accordance with EN 62061

Prerequisites:

- ▶ Common cause failure (CCF): $\beta = 2 \%$ (must be tested on implementation)
- ▶ Proof test interval: 20 years
- ▶ Operating interval (electromechanical components):
 - Sensor: 60 operations per hour
 - Actuator: 60 operations per hour
- ▶ Characteristic data of pushbuttons S1/S2:
 - B10d: 20.000.000
 - Dangerous failure rate: 50 %
- ▶ Characteristic data of contactors KM1/KM2:
 - B10d: 2,000,000
 - Dangerous failure rate: 65% (note oversizing)

Classification in accordance with EN 954-1

Depending on the application area and its respective regulations, this connection example is suitable for applications up to Category 4 of EN 954-1.

EN 62061	Safety Integrity Level	Subsystems
Safety-related control function (SRCF): Pushbuttons are operated simultaneously with both hands, to keep the operator away from the danger zone. Hazardous movement is stopped by releasing one or both pushbuttons; reactivation is possible once both pushbuttons are released. Further requirements relevant to two-hand circuits in accordance with EN 574 Type IIIC.	SIL 3	Sensor (pushbutton S1/S2) Logic (PNOZ s6) Actuator (contactor KM1, KM2)

Please note the further requirements of EN 62061, e.g. requirements for systematic safety integrity.

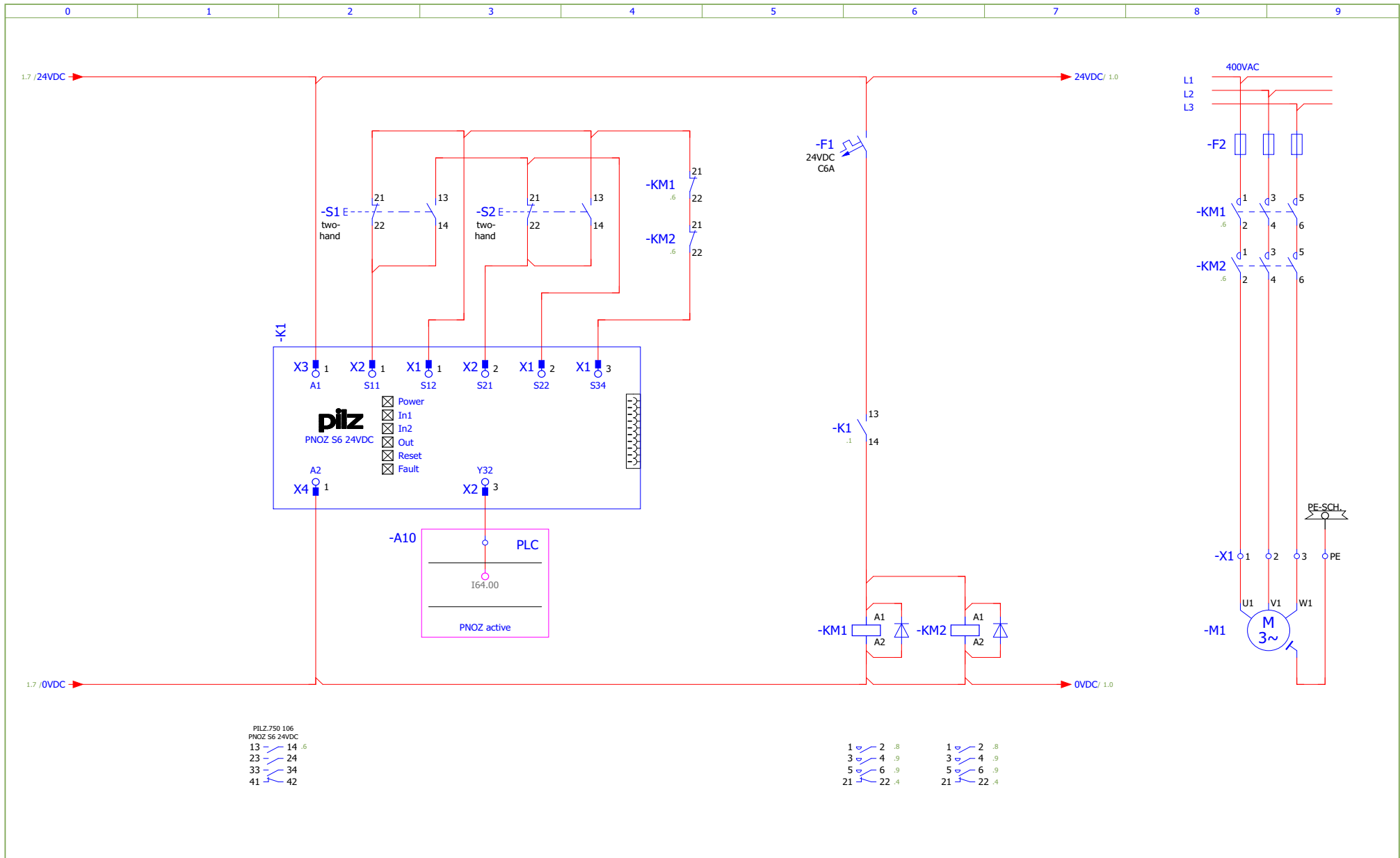

Revision	15.01.2009	Date	07.12.2005	EN ISO 13849-1:2006	PL e	Pilz GmbH & Co.KG Felix-Wankel-Str.2 73760 Ostfildern	Two-hand operation (request type IIIC, EN 574) extension contact by contactors	Mounting place + PNOZs6_1
Name	RDS	Name	WED	EN 62061:2005	SIL 3		Page:	1 / 1
		Dep.	CS					

PL e of EN ISO 13849-1, SIL 3 of EN 62061

PNOZ s6 - Requirements in accordance with EN 574 Type IIIC, contact expansion through PNOZ s10

Features

- ▶ Dual-channel operation with detection of shorts across contacts
- ▶ Simultaneity monitoring
- ▶ Contact expansion through PNOZ s10 (contact expander module)
- ▶ Feedback loop to monitor contact expansion
- ▶ Meets requirements in accordance with EN 574 Type IIIC

Description

Function

The two-hand control device PNOZ s6 (K2) is activated by operating both pushbuttons S3 and S4 simultaneously (simultaneity max. 500 ms), the safety contacts on K2 close. The contact expander module PNOZ s10 (K3) is started. Releasing one or both pushbuttons S3 / S4 will interrupt the input circuit on the two-hand control device K2, the safety contacts at K2 open. The contact expander module K3 shuts down. The safety contacts on the two-hand control device PNOZ s6 (K2) will not reclose until both pushbuttons S3 and S4 have been released and then re-operated simultaneously.

Settings on the unit

The connector between the safety relays PNOZ s6 (K2) and PNOZ s10 (K3) must be connected.

Start/reset

The two-hand control device PNOZ s6 can be started by operating pushbuttons S3 and S4 simultaneously when the feedback loop in the contact expander module PNOZ s10 (K3) is closed and contactors KM1 and KM2 have de-energised.

Feedback loop

The feedback loop on the safety relay PNOZ s6 (K2) is connected to the feedback loop on the contact expander module PNOZ s10 (K3).

The positive-guided N/C contacts on contactors KM1 and KM2 are monitored in feedback loop S12-S34 of the two-hand control device.

Safety assessment

- ▶ The two-hand control devices PNOZ s6 (K2), PNOZ s10 (K3) and contactors KM3 and KM4 must be installed in a single mounting area (control cabinet) in order to exclude a short across the output.
- ▶ Earth faults and shorts between contacts in the input circuit are detected.
- ▶ A fault on the device does not lead to the loss of the safety function.

- ▶ The distance of both pushbuttons S3 and S4 from the nearest danger zone must be large enough that if one of the pushbuttons is released, the dangerous movement is interrupted before the operator can reach the danger zone or before the operator can reach into the danger zone (see EN 999 „The positioning of protective equipment in respect of approach speeds of parts of the human body“).

Pilz products

Number	Designation	Order number
1	PNOZ s6	750 106
1	PNOZ s10	750 110

PL e of EN ISO 13849-1, SIL 3 of EN 62061

PNOZ s6 - Requirements in accordance with EN 574 Type IIIC, contact expansion through PNOZ s10

Safety-related characteristics in accordance with EN ISO 13849-1

Prerequisites:

- ▶ Common cause failure (CCF):
Requirements are considered to be met (must be tested on implementation)
- ▶ Mission time: 20 years
- ▶ Operating interval (electromechanical components):
 - Sensor: 60 operations per hour
 - Actuator: 60 operations per hour
- ▶ Characteristic data of pushbuttons S3/S4:
B10d: 20.000.000
- ▶ Characteristic data of contactors KM1/KM2:
B10d: 2,000,000 (note oversizing)

EN ISO 13849-1		Performance Level	Safety-related parts of the control system
Safety function:	Pushbuttons are operated simultaneously with both hands, to keep the operator away from the danger zone. Hazardous movement is stopped by releasing one or both pushbuttons; reactivation is possible once both pushbuttons are released. Further requirements relevant to two-hand circuits in accordance with EN 574 Type IIIC.	PL e	Sensor (pushbutton S3/S4) Logic (PNOZ s6) Logic (PNOZ s10) Actuator (contactor KM1, KM2)

Please note the further requirements of EN ISO 13849-1, e.g. requirements for avoiding systematic faults.

PL e of EN ISO 13849-1, SIL 3 of EN 62061

PNOZ s6 - Requirements in accordance with EN 574 Type IIIC, contact expansion through PNOZ s10

Safety-related characteristics in accordance with EN 62061

Prerequisites:

- ▶ Common cause failure (CCF): $\beta = 2 \%$ (must be tested on implementation)
- ▶ Proof test interval: 20 years
- ▶ Operating interval (electromechanical components):
 - Sensor: 60 operations per hour
 - Actuator: 60 operations per hour
- ▶ Characteristic data of pushbuttons S3/S4:
 - B10d: 20.000.000
 - Dangerous failure rate: 50 %
- ▶ Characteristic data of contactors KM1/KM2:
 - B10d: 2,000,000
 - Dangerous failure rate: 65% (note oversizing)

Classification in accordance with EN 954-1

Depending on the application area and its respective regulations, this connection example is suitable for applications up to Category 4 of EN 954-1.

EN 62061	Safety Integrity Level	Subsystems
Safety-related control function (SRCF): Pushbuttons are operated simultaneously with both hands, to keep the operator away from the danger zone. Hazardous movement is stopped by releasing one or both pushbuttons; reactivation is possible once both pushbuttons are released. Further requirements relevant to two-hand circuits in accordance with EN 574 Type IIIC.	SIL 3	Sensor (pushbutton S3/S4) Logic (PNOZ s6) Logic (PNOZ s10) Actuator (contactor KM1, KM2)

Please note the further requirements of EN 62061, e.g. requirements for systematic safety integrity.

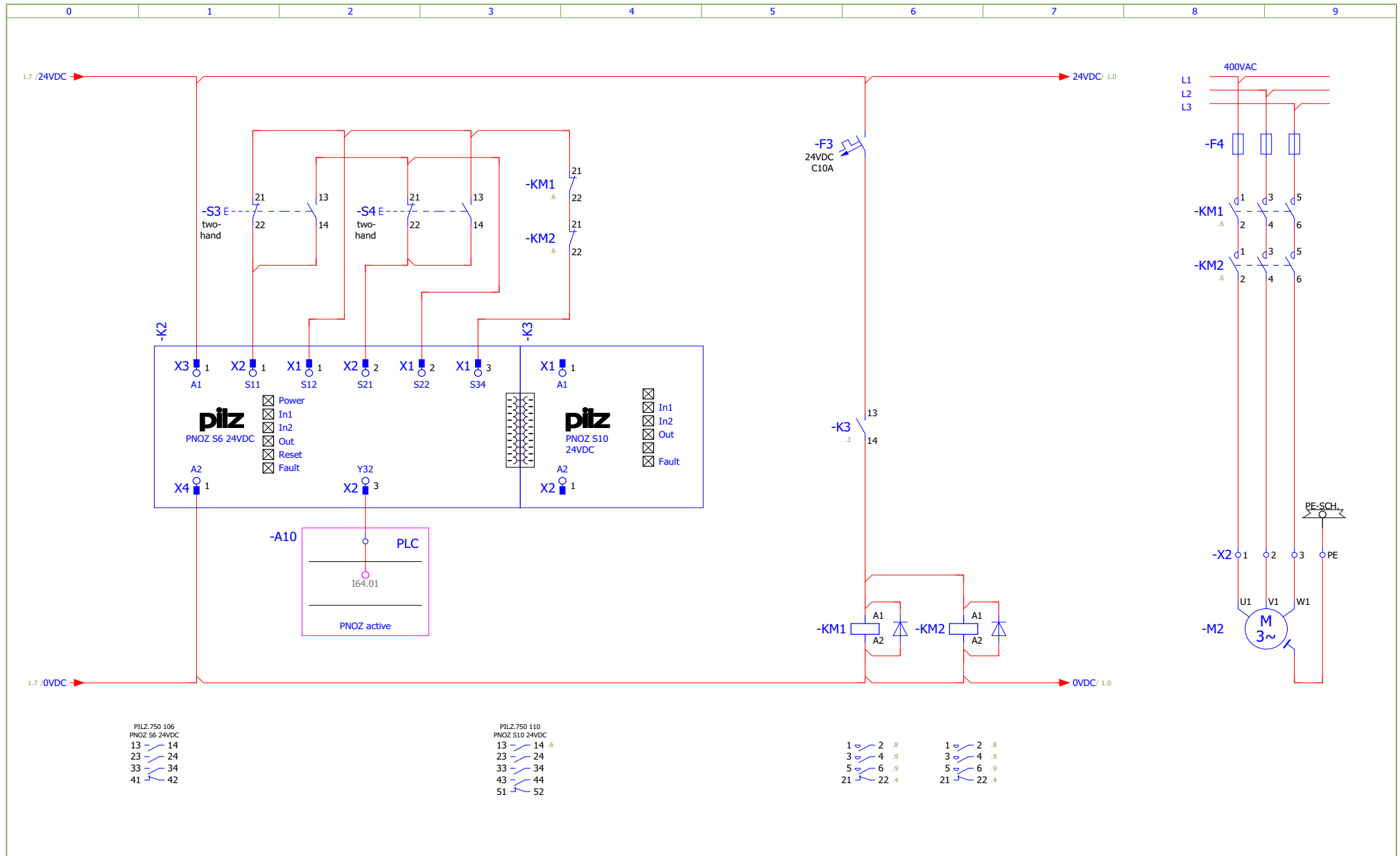

Revision	15.01.2009	Date	07.12.2005	EN ISO 13849-1:2006	PL e	Pilz GmbH & Co.KG Felix-Wankel-Str.2 73760 Ostfildern	Two-hand operation (request type IIIC, EN 574) extension contact by PNOZ s10	Mounting place + PNOZs6_2
Name	RDS	Name	WED	EN 62061:2005	SIL 3		Page:	1 / 1
		Dep.	CS					

PL b of EN ISO 13849-1

PNOZ s6.1 - Requirements in accordance with EN 574 Type IIIA

Features

- ▶ Dual-channel operation
- ▶ Simultaneity monitoring
- ▶ Requirements in accordance with EN 574 Type IIIA

Description

Function

The two-hand control device PNOZ s6.1 (K1) is activated by operating both pushbuttons S1 and S2 simultaneously (simultaneity max. 500 ms), the safety contacts on K1 close. Contactor KM1 energises.

Releasing one or both pushbuttons S1 / S2 will interrupt the input circuit on the two-hand control device K1, the safety contacts at K1 open. Contactor KM1 de-energises.

The safety contacts on the two-hand control device PNOZ s6.1 (K1) will not reclose until both pushbuttons S1 and S2 have been released and then re-operated simultaneously.

Settings on the unit

The terminator on the PNOZ s6.1 must be connected.

Start/reset

The two-hand control device PNOZ s6.1 can be started by operating pushbuttons S1 and S2 simultaneously when contactor KM1 has de-energised.

Safety assessment

- ▶ Earth faults in the input circuit are detected.
- ▶ A fault on the device does not lead to the loss of the safety function.
- ▶ The distance of both pushbuttons S1 and S2 from the nearest danger zone must be large enough that if one of the pushbuttons is released, the dangerous movement is interrupted before the operator can reach the danger zone or before the operator can reach into the danger zone (see EN 999 „The positioning of protective equipment in respect of approach speeds of parts of the human body“).
- ▶ The two-hand control device PNOZ s6.1 may **not be used on press controllers**. It is only suitable for use where the risk analysis has established a low level of risk.

Pilz products

Number	Designation	Order number
1	PNOZ s6.1	750 126

PL b of EN ISO 13849-1

PNOZ s6.1 - Requirements in accordance with EN 574 Type IIIA

Safety-related characteristics in accordance with EN ISO 13849-1

Prerequisites:

- ▶ Mission time: 20 years (Contactor KM1 must be changed after 3.8 years)
- ▶ Operating interval (electromechanical components):
 - Sensor: 60 operations per hour
 - Actuator: 60 operations per hour
- ▶ Characteristic data of pushbuttons S1/S2: B10d: 20.000.000
- ▶ Characteristic data of contactor KM1: B10d: 2,000,000

EN ISO 13849-1		Performance Level	Safety-related parts of the control system
Safety function:	Pushbuttons are operated simultaneously with both hands, to keep the operator away from the danger zone. Hazardous movement is stopped by releasing one or both pushbuttons; reactivation is possible once both pushbuttons are released. Further requirements relevant to two-hand circuits in accordance with EN 574 Type IIIC.	PL b	Sensor (pushbutton S1, S2) Logic (PNOZ s6.1) Actuator (contactor KM1)

Please note the further requirements of EN ISO 13849-1, e.g. requirements for avoiding systematic faults.

Classification in accordance with EN 954-1

Depending on the application area and its respective regulations, this connection example is suitable for applications up to Category 1 of EN 954-1.

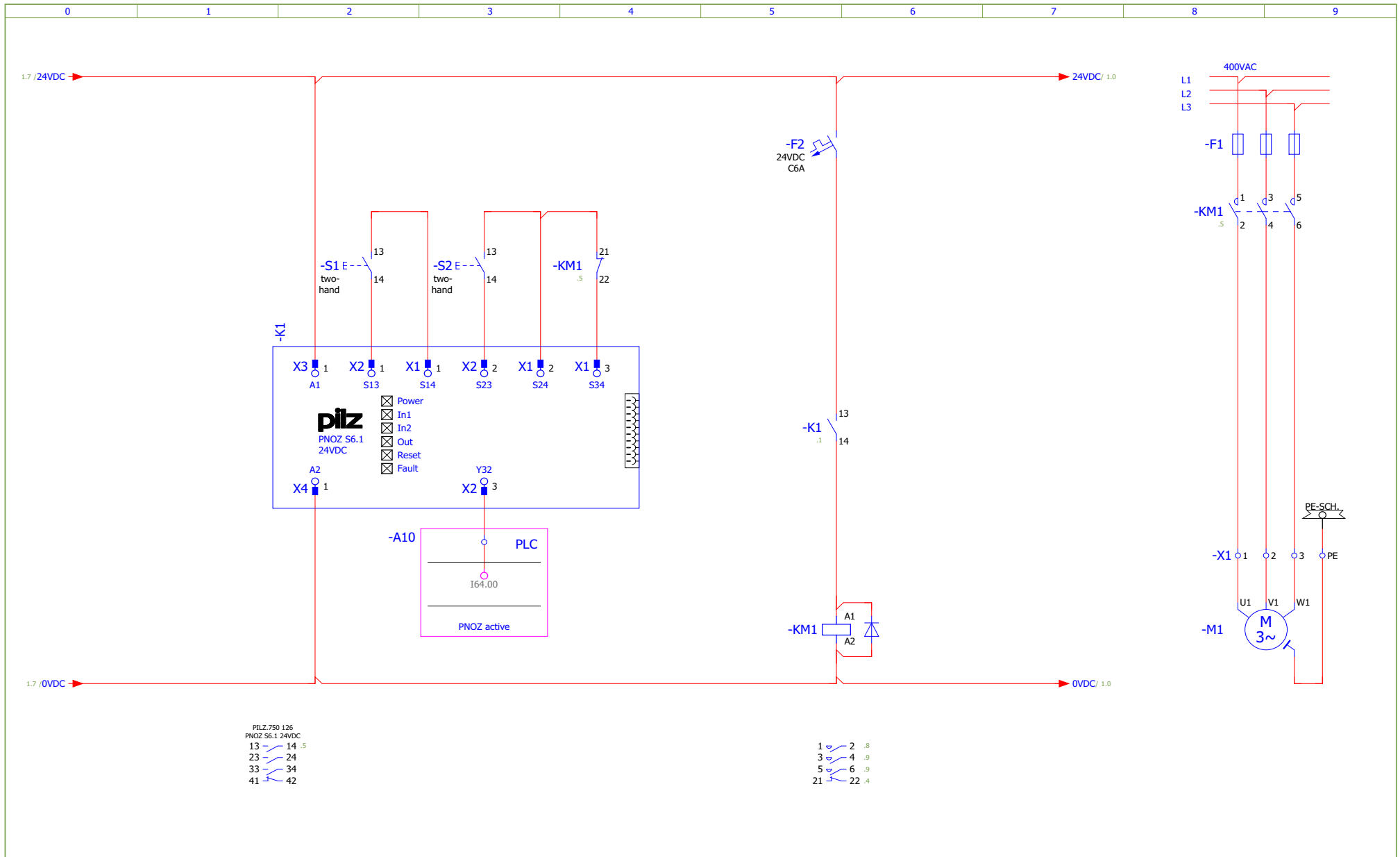

Revision	15.01.2009	Date	07.12.2005	EN ISO 13849-1:2006	PL b	Pilz GmbH & Co.KG Felix-Wankel-Str.2 73760 Ostfildern	Two-hand operation (request type IIIA, EN 574)	Mounting place
Name	RDS	Name	WED					+ PNOZs6.1_1
		Dep.	CS					Page: 1 / 1

Contents	Page
<hr/> Further applications <hr/>	
PNOZsigma contact ex- pander module – PNOZ s7.1 and PNOZ s7.2 with base unit PNOZ s4	PL e of EN ISO 13849-1, SIL 3 of EN 62061 2.5-2
PNOZsigma contact ex- pander module – PNOZ s7.1 and PNOZ s7.2 with base unit PNOZ X4	PL e of EN ISO 13849-1, SIL 3 of EN 62061 2.5-7

PL e of EN ISO 13849-1, SIL 3 of EN 62061

PNOZsigma contact expander module - PNOZ s7.1 and PNOZ s7.2 with base unit PNOZ s4

Features

- ▶ Dual-channel operation with detection of shorts across contacts
- ▶ Monitored reset with falling edge
- ▶ Contact expansion through PNOZ s7.1 and PNOZ s7.2
- ▶ Feedback loop to monitor contact expansion
- ▶ Supply voltage via PNOZsigma connector

Description

E-STOP function

When the E-STOP pushbutton S1 is operated, the input circuit on the safety relay PNOZ s4 (K1) is interrupted, the safety contacts on K1 open. As a result, the input circuit on the contact expander modules PNOZ s7.1 (K2) and PNOZ s7.2 (K3-K4) is interrupted via the PNOZsigma connector, the safety contacts at K2 to K4 open.

Settings on the unit

- ▶ The connectors between the safety relays PNOZ s4 (K1), PNOZ s7.1 (K2) and PNOZ s7.2 (K3-K4) must be connected.
- ▶ The terminator on the PNOZ s7.2 (K4) must be connected.
- ▶ The operating mode selector switch (mode) on the safety relay PNOZ s4 (K1) must be set to "Monitored reset, falling edge with detection of shorts across contacts (In2-)".

Start/reset

The safety relay PNOZ s4 (K1) can be started by pressing reset button S2 if:

- ▶ E-STOP pushbutton S1 has not been operated and
- ▶ Safety relays K2 to K4 have de-energised and
- ▶ Contactors KM1 to KM6 have de-energised.

Feedback loop

The positive-guided N/C contacts on contactors KM1 to KM6 are monitored in feedback loop S12-S34 of safety relay PNOZ s4 (K1).

Safety assessment

- ▶ The safety relays PNOZ s4, PNOZ s7.1, PNOZ s7.2 and contactors KM1 to KM6 must be installed in a single mounting area (control cabinet) in order to exclude a short across the output.
- ▶ Earth faults and shorts between contacts in the input circuit are detected.
- ▶ A fault on the device does not lead to the loss of the safety function.
- ▶ The safety relays PNOZ s4 (K1), PNOZ s7.1 (K2) and PNOZ s7.2 (K3-K4) can be started when the input circuit at K1 is closed first, followed by the reset button S2. This avoids an unwanted reset before the input circuit is closed or as a result of the reset button being overridden.
- ▶ If the position of the operating mode selector switch (mode) is changed during operation, an error message will be

triggered; the safety contacts on K1 open. This fault condition can only be rectified by switching the supply voltage on the safety relay PNOZ s4 (K1) off and then on again.

Pilz products

Number	Designation	Order number
1	PNOZ s4	750 104
1	PNOZ s7.1	750 167
2	PNOZ s7.2	750 177
1	PITestop Set1.1	400 410

PL e of EN ISO 13849-1, SIL 3 of EN 62061

PNOZsigma contact expander module - PNOZ s7.1 and PNOZ s7.2 with base unit PNOZ s4

Safety-related characteristics in accordance with EN ISO 13849-1

Prerequisites:

- ▶ Common cause failure (CCF):
Requirements are considered to be met (must be tested on implementation)
- ▶ Mission time: 20 years
- ▶ Operating interval (electromechanical components):
 - Sensor: One operation per week
 - Actuator: One operation per week
- ▶ Characteristic data of contactors KM1 to KM6:
B10d: 2,000,000

EN ISO 13849-1		Performance Level	Safety-related parts of the control system
Safety function 1:	Machine shut down via E-STOP	PL e	Sensor (PITestop S1) Logic (PNOZ s4) Logic (PNOZ s7.1) Actuator (contactors KM1, KM2)
Safety function 2:	Machine shut down via E-STOP	PL e	Sensor (PITestop S1) Logic (PNOZ s4) Logic (PNOZ s7.1) Logic (PNOZ s7.2 K3) Actuator (contactors KM3, KM4)
Safety function 3:	Machine shut down via E-STOP	PL e	Sensor (PITestop S1) Logic (PNOZ s4) Logic (PNOZ s7.1) Logic (PNOZ s7.2 K4) Actuator (contactors KM5, KM6)

Please note the further requirements of EN ISO 13849-1, e.g. requirements for avoiding systematic faults.

PL e of EN ISO 13849-1, SIL 3 of EN 62061

PNOZsigma contact expander module - PNOZ s7.1 and PNOZ s7.2 with base unit PNOZ s4

Safety-related characteristics in accordance with EN 62061

Prerequisites:

- ▶ Common cause failure (CCF): $\beta = 2 \%$ (must be tested on implementation)
- ▶ Proof test interval: 20 years
- ▶ Operating interval (electromechanical components):
 - Sensor: One operation per week
 - Actuator: One operation per week
- ▶ Characteristic data of contactors KM1 to KM6:
 B10d: 2,000,000
 Dangerous failure rate: 65%

EN 62061		Safety Integrity Level	Subsystems
Safety-related control function 1 (SRCF 1):	Machine shut down via E-STOP	SIL 3	Sensor (PITestop S1) Logic (PNOZ s4) Logic (PNOZ s7.1) Actuator (contactors KM1, KM2)
Safety-related control function 2 (SRCF 2):	Machine shut down via E-STOP	SIL 3	Sensor (PITestop S1) Logic (PNOZ s4) Logic (PNOZ s7.1) Logic (PNOZ s7.2 K3) Actuator (contactors KM3, KM4)
Safety-related control function 3 (SRCF 3):	Machine shut down via E-STOP	SIL 3	Sensor (PITestop S1) Logic (PNOZ s4) Logic (PNOZ s7.1) Logic (PNOZ s7.2 K4) Actuator (contactors KM5, KM6)

Please note the further requirements of EN 62061, e.g. requirements for systematic safety integrity.

Classification in accordance with EN 954-1

Depending on the application area and its respective regulations, this connection example is suitable for applications up to Category 4 of EN 954-1.

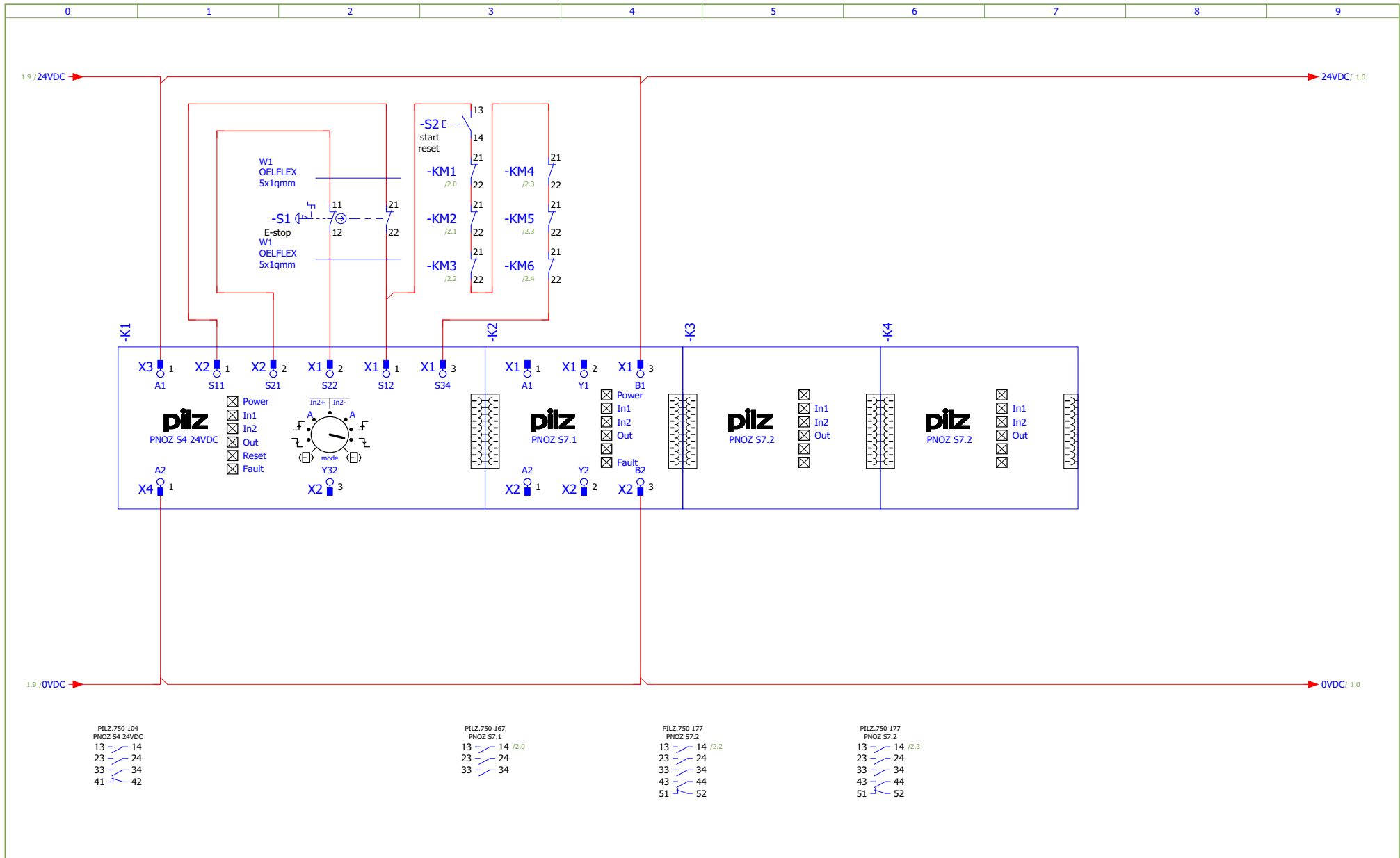

Revision	15.01.2009	Date	07.12.2005	EN ISO 13849-1:2006	PL e	 Pilz GmbH & Co.KG Felix-Wankel-Str.2 73760 Ostfildern	Connect base unit PNOZ sigma with contact expansion module PNOZ s7.1 and contact expansion module PNOZ s7.2	Mounting place + PNOZs7.1_1
Name	RDS	Name	RDS	EN 62061:2005	SIL 3			Page: 1 / 2
		Dep.	CS					

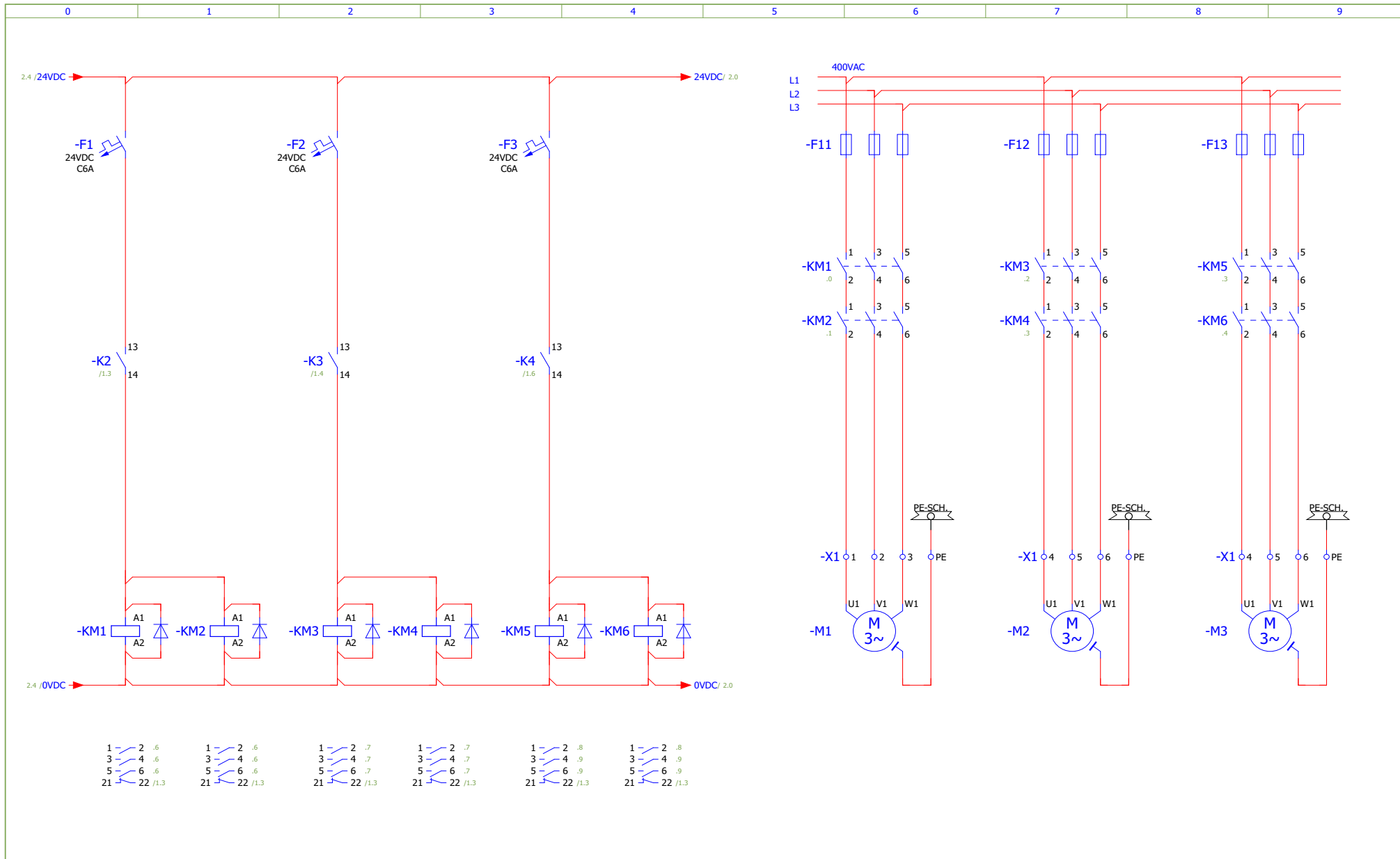

Revision	15.01.2009	Date	07.12.2005	EN ISO 13849-1:2006	PL e	Pilz GmbH & Co. KG Felix-Wankel-Str.2 73760 Ostfildern	Connect base unit PNOZ sigma with contact expansion module PNOZ s7.1 and contact expansion module PNOZ s7.2	Mounting place + PNOZs7.1_1
Name	RDS	Name	RDS	EN 62061:2005	SIL 3			Page: 2 / 2
		Dep.	CS					

PL e of EN ISO 13849-1, SIL 3 of EN 62061

PNOZsigma contact expander module - PNOZ s7.1 and PNOZ s7.2 with base unit PNOZ X4

Features

- ▶ Dual-channel operation with detection of shorts across contacts
- ▶ Monitored reset
- ▶ Contact expansion through PNOZ s7.1 and PNOZ s7.2
- ▶ Feedback loop to monitor contact expansion

Description

E-STOP function

When the E-STOP pushbutton S1 is operated, the input circuit on the safety relay PNOZ X4 (K1) is interrupted, the safety contacts on K1 open. As a result the input circuit on the contact expander module PNOZ s7.1 (K2) is interrupted, the safety contacts on K2 and K3 open.

Settings on the unit

- ▶ The connector between the two safety relays PNOZ s7.1 (K2) and PNOZ s7.2 (K3) must be connected.
- ▶ The terminators on PNOZ s7.1 (K2) and PNOZ s7.2 (K3) must be connected.

Start/reset

The safety relay PNOZ X4 (K1) can be started by pressing reset button S2 if:

- ▶ E-STOP pushbutton S1 has not been operated and
- ▶ Safety relays PNOZ s7.1 (K2) and PNOZ s7.2 (K3) have de-energised and

- ▶ Contactors KM1 to KM4 have de-energised.

Feedback loop

The positive-guided N/C contact on the safety relay PNOZ s7.1 (K2) is monitored in feedback loop Y1-Y2 of safety relay PNOZ X4 (K1).

Safety assessment

- ▶ The safety relays PNOZ X4, PNOZ s7.1, PNOZ s7.2 and contactors KM1 to KM4 must be installed in a single mounting area (control cabinet) in order to exclude a short across the output.
- ▶ Earth faults and shorts between contacts in the input circuit are detected.
- ▶ A fault on the device does not lead to the loss of the safety function.
- ▶ The safety relays PNOZ X4 (K1), PNOZ s7.1 (K2) and PNOZ s7.2 (K3) can be started when the input circuit at K1 is closed first, followed by the reset button S2. This avoids an unwanted reset before the input circuit is closed or as a result of the reset button being overridden.

Pilz products

Number	Designation	Order number
1	PNOZ X4	774 730
1	PNOZ s7.1	750 167
1	PNOZ s7.2	750 177
1	PITestop Set1.1	400 410

PL e of EN ISO 13849-1, SIL 3 of EN 62061

PNOZsigma contact expander module - PNOZ s7.1 and PNOZ s7.2 with base unit PNOZ X4

Safety-related characteristics in accordance with EN ISO 13849-1

Prerequisites:

- ▶ Common cause failure (CCF):
Requirements are considered to be met (must be tested on implementation)
- ▶ Mission time: 20 years
- ▶ Operating interval (electromechanical components):
 - Sensor: One operation per week
 - Actuator: One operation per week
- ▶ Characteristic data of contactors KM1 to KM4:
B10d: 2,000,000

EN ISO 13849-1		Performance Level	Safety-related parts of the control system
Safety function 1:	Machine shut down via E-STOP	PL e	Sensor (PITestop S1) Logic (PNOZ X4) Logic (PNOZ s7.1) Actuator (contactors KM1, KM2)
Safety function 2:	Machine shut down via E-STOP	PL e	Sensor (PITestop S1) Logic (PNOZ X4) Logic (PNOZ s7.1) Logic (PNOZ s7.2) Actuator (contactors KM3, KM4)

Please note the further requirements of EN ISO 13849-1, e.g. requirements for avoiding systematic faults.

PL e of EN ISO 13849-1, SIL 3 of EN 62061

PNOZsigma contact expander module - PNOZ s7.1 and PNOZ s7.2 with base unit PNOZ X4

Safety-related characteristics in accordance with EN 62061

Prerequisites:

- ▶ Common cause failure (CCF): $\beta = 2 \%$ (must be tested on implementation)
- ▶ Proof test interval: 20 years
- ▶ Operating interval (electromechanical components):
 - Sensor: One operation per week
 - Actuator: One operation per week
- ▶ Characteristic data of contactors KM1 to KM4:
 - B10d: 2,000,000
 - Dangerous failure rate: 65%

EN 62061		Safety Integrity Level	Subsystems
Safety-related control function 1 (SRCF 1):	Machine shut down via E-STOP	SIL 3	Sensor (PITestop S1) Logic (PNOZ X4) Logic (PNOZ s7.1) Actuator (contactors KM1, KM2)
Safety-related control function 2 (SRCF 2):	Machine shut down via E-STOP	SIL 3	Sensor (PITestop S1) Logic (PNOZ X4) Logic (PNOZ s7.1) Logic (PNOZ s7.2) Actuator (contactors KM3, KM4)

Please note the further requirements of EN 62061, e.g. requirements for systematic safety integrity.

Classification in accordance with EN 954-1

Depending on the application area and its respective regulations, this connection example is suitable for applications up to Category 4 of EN 954-1.

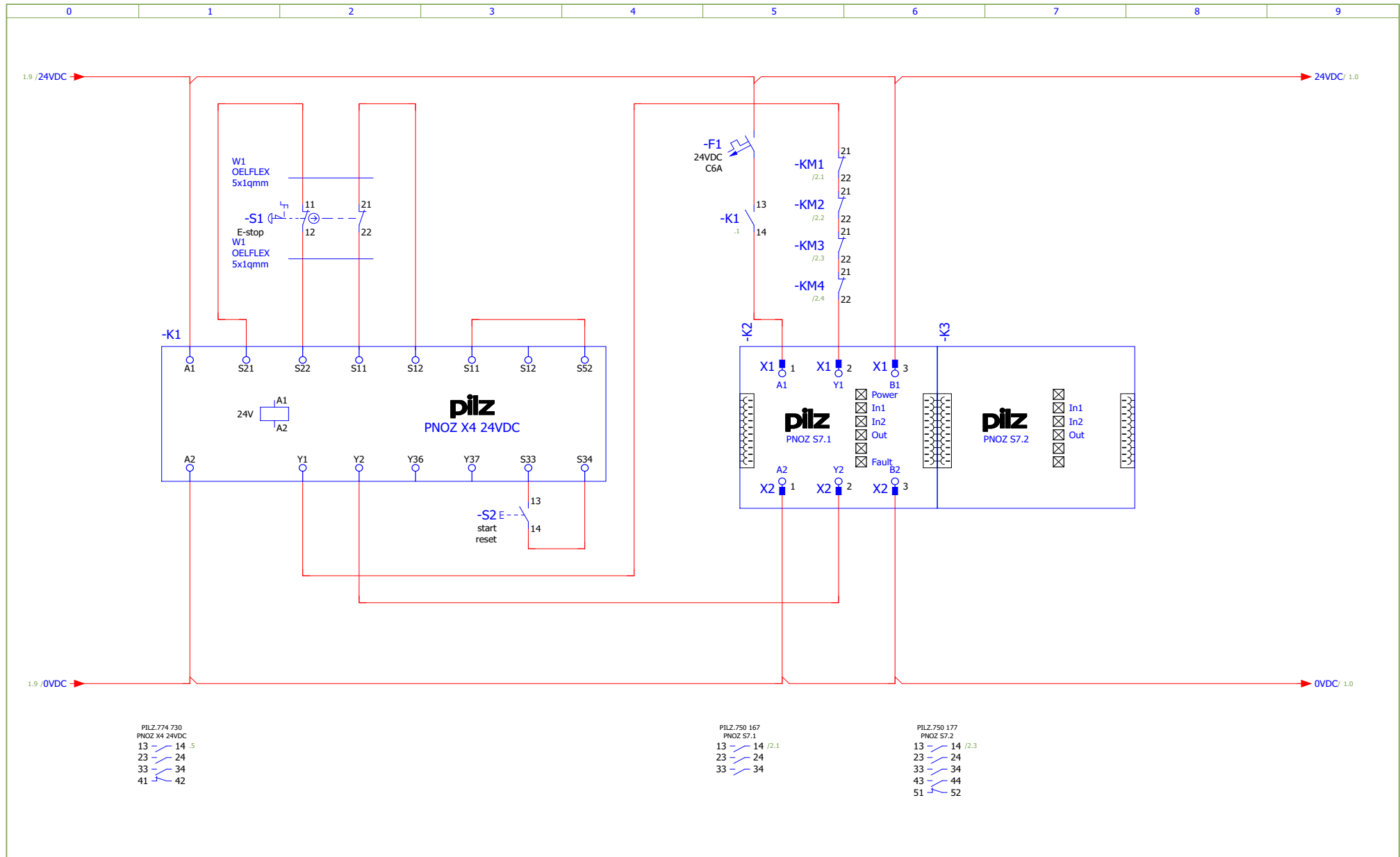

Revision	15.01.2009	Date	07.12.2005	EN ISO 13849-1:2006	PL e	Pilz GmbH & Co.KG Felix-Wankel-Str.2 73760 Ostfildern	Contact expansion module PNOZ s7.1 and contact expansion module PNOZ s7.2 without base unit PNOZ sigma	Mounting place	+ PNOZs7.1_2
Name	RDS	Name	RDS	EN 62061:2005	SIL 3			Page:	1 / 2
		Dep.	CS						

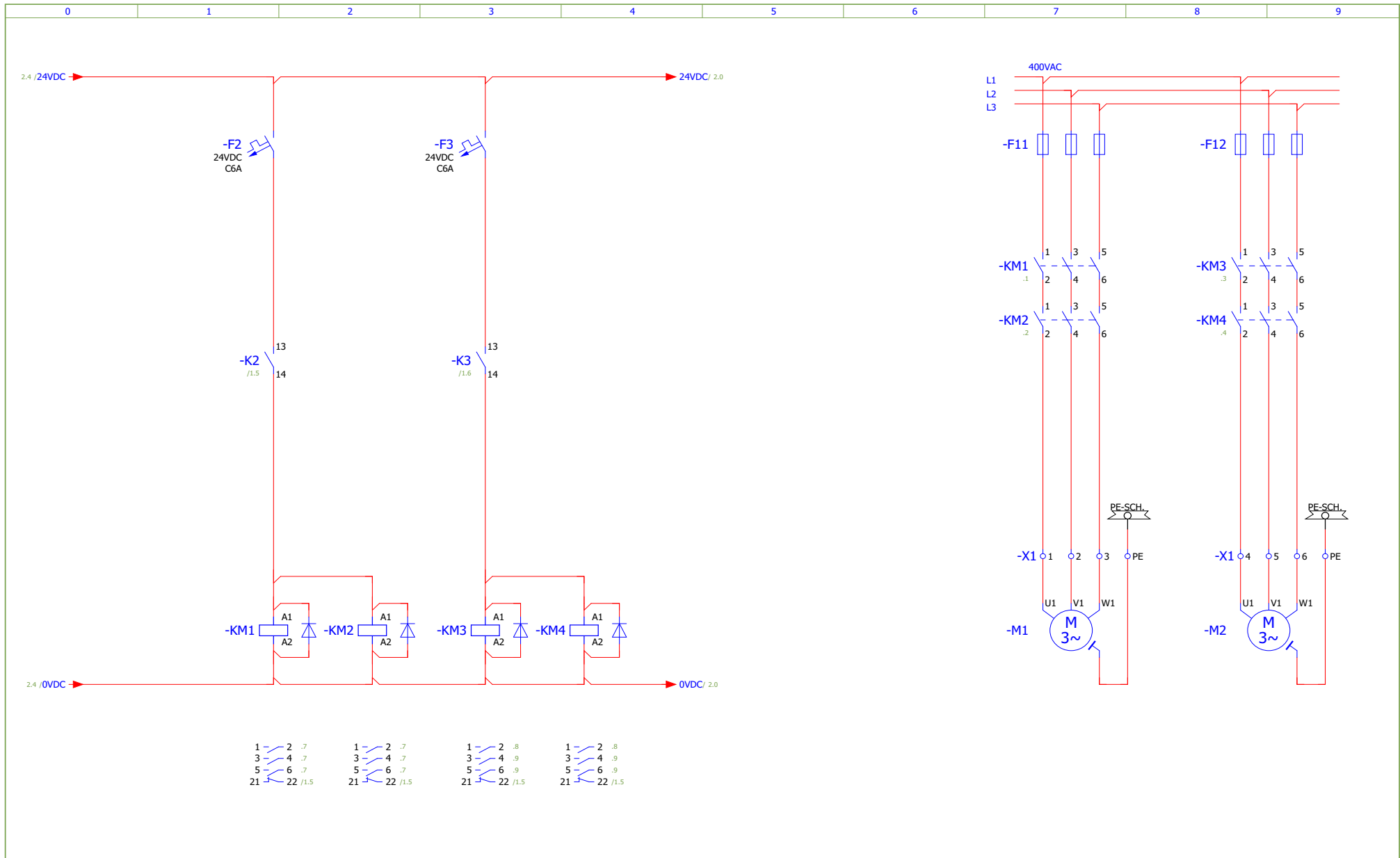

Revision	15.01.2009	Date	07.12.2005	EN ISO 13849-1:2006	PL e	 Pilz GmbH & Co.KG Felix-Wankel-Str.2 73760 Ostfildern	Contact expansion module PNOZ s7.1 and contact expansion module PNOZ s7.2 without base unit PNOZ sigma	Mounting place + PNOZs7.1_2
Name	RDS	Name	RDS	EN 62061:2005	SIL 3			Page: 2 / 2
		Dep.	CS					

Contents	Page
Service	
Pre-sales/after sale	
	Professional services 3.1-2
Your partner for practical training	
	Customised training concepts 3.1-3
Business terms and conditions	
	Delivery and payment-terms 3.1-4

Pre-sales/after sales Professional services



We can provide consulting and engineering, training and support, from the project configuration phase through to commissioning.



Risk Assessment
Assessment of the hazards and risks on plant and machinery, based on norms and standards.



Safety Concept
Based on the risk analysis, appropriate protective measures can be selected and a safety concept drawn up.



Safety Design
As part of the safety design, Pilz produces detailed documentation regarding the implementation, taking into account the safety concept.



System Implementation
Pilz undertakes all the tasks required to implement a project: component selection, preparation of circuit diagrams, programming, control cabinet, installation, commissioning.



Safety Validation
All the relevant safety-related documents are examined, check lists are created and the plant and machinery checked.



CE Marking
Co-ordination and implementation of all the activities necessary for the CE conformity of plant and machinery.



Plant Assessment
Analysis and assessment of the safety-related condition of your plant and machinery. Proposal of basic recommendations for improvement.



Training and Education
A wide range of seminars and training courses on machinery safety helps to communicate the fundamentals for minimising risk and assuring your success.



Technical Support
Our engineers can support you in the selection, use and application of our products. They are in constant contact with customers from the widest range of areas and industrial sectors and are happy to answer your queries at any time.



E-Mail:
techsupport@pilz.de



24-hour hotline:
+49 711 3409-444



Supply and Repair Service
From a fast, economical repair through to a long supply guarantee to safeguard your investment – always expect more from Pilz.



Certificates and Approvals
Pilz is certified to DIN ISO 9001. International approvals and certification from recognised test houses confirm our products' suitability for worldwide use.



Internet
Our homepage at www.pilz.com provides the latest information, electronic shopping, direct dialogue and enquiry functions as well as extensive download options.



E-Business
The focus of Pilz's E-Business activities is to strengthen customer orientation through the use of new media and to increase added value via a supplementary business model for Business-to-Business.



Worldwide Representatives
Our worldwide network of subsidiaries and sales partners ensures comprehensive support and assistance with your questions and problems.

Your partner for practical training

Customised training concepts



Benefit from the expertise of one of the leading brands in automation technology

As a result of many years' experience, work with the standards' committees and thorough expertise in the area of safe automation technology, Pilz is the ideal partner for practical training. Pilz offers a large number of seminars and courses on the widest range of subjects to both manufacturers and users alike – worldwide, in various languages, to the same standard. For example:

- ▶ General safety-related issues
- ▶ New machinery safety standards
- ▶ Programming and maintenance
- ▶ Error evaluation and diagnostics



Whether you need a basic seminar or an advanced course, we can help to prepare you individually in the best way possible for everyday work situations. We will happily do this at your premises, directly on the machine.

More information on our complete seminar program, conditions of registration and seminar venues can be found on the Internet, where you also have the opportunity to register directly online:

▶ www.pilz.com

Why not find out more about our attractive range of training courses!



Business terms and conditions

Terms of delivery and payment



The terms of delivery and of payment of the respective Pilz company with whom a sales contract is closed are applied. As a rule this is the Pilz company that places the order. Please select the legal contract partner from the order confirmation.

▶ AT

Pilz Ges.m.b.H.
Sichere Automation
Modecenterstraße 14
1030 Wien
Austria
Telephone: +43 1 7986263-0
Telefax: +43 1 7986264
E-Mail: pilz@pilz.at
Internet: www.pilz.at

▶ AU

Pilz Australia
Safe Automation
Suite C1, 756 Blackburn Road
Clayton, Melbourne VIC 3168
Australia
Telephone: +61 3 95446300
Telefax: +61 3 95446311
E-Mail: safety@pilz.com.au
Internet: www.pilz.com.au

▶ BE ▶ LU

Pilz Belgium
Safe Automation
Bijenstraat 4
9051 Gent (Sint-Denijs-Westrem)
Belgium
Telephone: +32 9 3217570
Telefax: +32 9 3217571
E-Mail: info@pilz.be
Internet: www.pilz.be

▶ BR

Pilz do Brasil
Automação Segura
Rua Ártico, 123 - Jd. do Mar
09726-300
São Bernardo do Campo - SP
Brazil
Telephone: +55 11 4337-1241
Telefax: +55 11 4337-1242
E-Mail: pilz@pilz.com.br
Internet: www.pilz.com.br

▶ CH

Pilz Industrieelektronik GmbH
Gewerbepark Hintermättli
Postfach 6
5506 Mägenwil
Switzerland
Telephone: +41 62 88979-30
Telefax: +41 62 88979-40
E-Mail: pilz@pilz.ch
Internet: www.pilz.ch

▶ CN

Pilz Industrial Automation
Trading (Shanghai) Co., Ltd.
Safe Automation
Rm. 704-706
No. 457 Wu Lu Mu Qi (N) Road
Shanghai 200040
China
Telephone: +86 21 62494658
Telefax: +86 21 62491300
E-Mail: sales@pilz.com.cn
Internet: www.pilz.com.cn

▶ DE

Pilz GmbH & Co. KG
Felix-Wankel-Straße 2
73760 Ostfildern
Germany
Telephone: +49 711 3409-0
Telefax: +49 711 3409-133
E-Mail: pilz.gmbh@pilz.de
Internet: www.pilz.de

▶ DK

Pilz Skandinavien K/S
Safe Automation
Ellegaardvej 25 L
6400 Sønderborg
Denmark
Telephone: +45 74436332
Telefax: +45 74436342
E-Mail: pilz@pilz.dk
Internet: www.pilz.dk

▶ ES

Pilz Industrieelektronik S.L.
Safe Automation
Camí Ral, 130
Polígono Industrial Palou Nord
08400 Granollers
Spain
Telephone: +34 938497433
Telefax: +34 938497544
E-Mail: pilz@pilz.es
Internet: www.pilz.es

▶ FI

Pilz Skandinavien K/S
Safe Automation
Nuijamiestentie 5 A
00400 Helsinki
Finland
Telephone: +358 9 27093700
Telefax: +358 9 27093709
E-Mail: pilz.fi@pilz.fi
Internet: www.pilz.fi

▶ FR

Pilz France Electronic
1, rue Jacob Mayer
BP 12
67037 Strasbourg Cedex 2
France
Telephone: +33 3 88104000
Telefax: +33 3 88108000
E-Mail: siege@pilz-france.fr
Internet: www.pilz.fr

▶ GB

Pilz Automation Technology
Safe Automation
Willow House, Medicott Close
Oakley Hay Business Park
Corby
Northants NN18 9NF
United Kingdom
Telephone: +44 1536 460766
Telefax: +44 1536 460866
E-Mail: sales@pilz.co.uk
Internet: www.pilz.co.uk

▶ IE

Pilz Ireland Industrial Automation
Cork Business and Technology Park
Model Farm Road
Cork
Ireland
Telephone: +353 21 4346535
Telefax: +353 21 4804994
E-Mail: sales@pilz.ie
Internet: www.pilz.ie

▶ IT

Pilz Italia Srl
Automazione sicura
Via Meda 2/A
22060 Novedrate (CO)
Italy
Telephone: +39 031 789511
Telefax: +39 031 789555
E-Mail: info@pilz.it
Internet: www.pilz.it

▶ JP

Pilz Japan Co., Ltd.
Safe Automation
Shin-Yokohama Fujika Building 5F
2-5-9 Shin-Yokohama
Kohoku-ku
Yokohama 222-0033
Japan
Telephone: +81 45 471-2281
Telefax: +81 45 471-2283
E-Mail: pilz@pilz.co.jp
Internet: www.pilz.jp

▶ KR

Pilz Korea Ltd.
Safe Automation
9F Jo-Yang Bld. 50-10
Chungmuro2-Ga Jung-Gu
100-861 Seoul
Republic of Korea
Telephone: +82 2 2263 9541
Telefax: +82 2 2263 9542
E-Mail: info@pilzkorea.co.kr
Internet: www.pilzkorea.co.kr

▶ ...

In many countries we are represented by sales partners.

Please refer to our homepage for further details or contact our headquarters.

▶ MX

Pilz de México, S. de R.L. de C.V.
Automatización Segura
Circuito Pintores 170
Cd. Satélite
Naucalpan, Méx. 53100
Mexico
Telephone: +52 55 5572 1300
Telefax: +52 55 5572 1300
E-Mail: info@mx.pilz.com
Internet: www.pilz.com.mx

▶ NL

Pilz Nederland
Veilige automatisering
Postbus 186
4130 ED Vianen
Netherlands
Telephone: +31 347 320477
Telefax: +31 347 320485
E-Mail: info@pilz.nl
Internet: www.pilz.nl

▶ NZ

Pilz New Zealand
Safe Automation
5 Nixon Road
Mangere
Auckland
New Zealand
Telephone: +64 9 6345350
Telefax: +64 9 6345352
E-Mail: t.catterson@pilz.co.nz
Internet: www.pilz.co.nz

▶ PL

Pilz Polska Sp. z o.o.
Safe Automation
ul. Marywilska 34H
03-231 Warszawa
Poland
Telephone: +48 22 8847100
Telefax: +48 22 8847109
E-Mail: info@pilz.pl
Internet: www.pilz.pl

▶ Technical support

+49 711 3409-444

Pilz GmbH & Co. KG
Felix-Wankel-Straße 2
73760 Ostfildern, Germany
Telephone: +49 711 3409-0
Telefax: +49 711 3409-133
E-Mail: pilz.gmbh@pilz.de
Internet: www.pilz.com

**▶ PT**

Pilz Industrieelektronik S.L.
R. Eng Duarte Pacheco, 120
4 Andar Sala 21
4470-174 Maia
Portugal
Telephone: +351 229407594
Telefax: +351 229407595
E-Mail: pilz@pilz.es
Internet: www.pilz.es

▶ SE

Pilz Skandinavien K/S
Safe Automation
Energigatan 10 B
43437 Kungälv
Sweden
Telephone: +46 300 13990
Telefax: +46 300 30740
E-Mail: pilz.se@pilz.dk
Internet: www.pilz.se

▶ TR

Pilz Emniyet Otomasyon
Ürünleri ve Hizmetleri Tic. Ltd. Şti.
Kayışdağı Cad. Beykonağı Plaza
No:130 K:2 D:2
Kayışdağı-İstanbul
Turkey
Telephone: +90 216 5775550
Telefax: +90 216 5775549
E-Mail: pilz.tr@pilz.de
Internet: www.pilz.com.tr

▶ US ▶ CA

Pilz Automation Safety L.P.
7150 Commerce Boulevard
Canton
Michigan 48187
USA
Telephone: +1 734 354 0272
Telefax: +1 734 354 3355
E-Mail: info@pilzusa.com
Internet: www.pilzusa.com

