



Sample Kit 2010



SMD PTC Thermistors

for Limit Temperature Sensing
Superior Series

Features and applications for SMD PTC thermistors

Features

- Qualification based on AEC-Q200 rev. C
- Suitable for reflow and wave soldering (up to 280 °C)
- Fast and reliable response
- RoHS-compatible
- UL approval to UL1434 pending
- Lead-free tinned terminations

Applications

- Over-temperature protection of power components
- DC/DC converters
- SMPS, adapters
- Notebooks, game consoles
- Lighting: LED lights, dimmers, ballasts
- Automotive LED lighting
- Li-Ion battery pack protection
- Hifi amplifiers

Application circuit examples

Over-temperature detection circuit and its output voltage

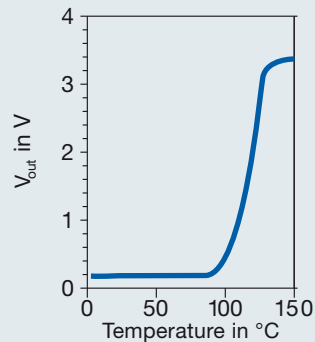
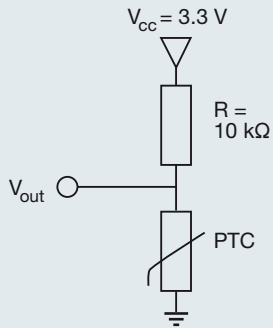

Example of over-temperature detection for multiple hot spots

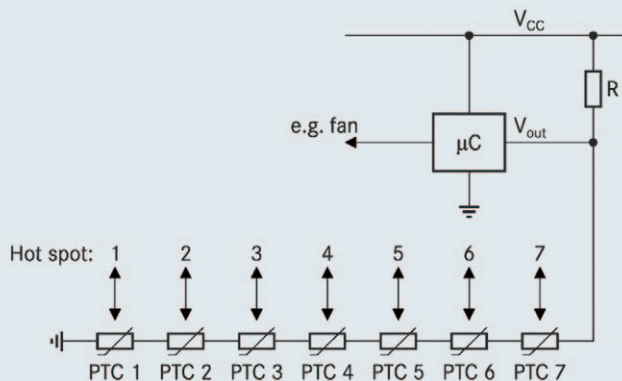

Components

EIA 0402 75 °C	EIA 0402 85 °C	EIA 0402 95 °C	EIA 0402 105 °C	EIA 0402 115 °C	EIA 0402 125 °C	EIA 0402 135 °C		
-------------------	-------------------	-------------------	--------------------	--------------------	--------------------	--------------------	--	--

EIA 0603 85 °C	EIA 0603 95 °C	EIA 0603 105 °C	EIA 0603 115 °C	EIA 0603 125 °C	EIA 0603 135 °C	EIA 0603 145 °C		
-------------------	-------------------	--------------------	--------------------	--------------------	--------------------	--------------------	--	--

EIA 0805 70 °C	EIA 0805 80 °C	EIA 0805 90 °C	EIA 0805 100 °C	EIA 0805 110 °C	EIA 0805 120 °C	EIA 0805 130 °C		
-------------------	-------------------	-------------------	--------------------	--------------------	--------------------	--------------------	--	--

Product range

Electrical specifications and ordering codes							
EIA case size	$T_{\text{sense},1}$ (@ 4.7 k Ω) [°C]	$T_{\text{sense},2}$ (@ 47 k Ω) [°C]	R_R ($V \leq V_{\text{max}}$) [Ω]	ΔR_R [%]	Ordering code		
Superior series, case sizes 0402 and 0603							
0402	75 \pm 5	–	470	\pm 50	B59421A0075A062		
0402	85 \pm 5	–	470	\pm 50	B59421A0085A062		
0402	95 \pm 5	–	470	\pm 50	B59421A0095A062		
0402	105 \pm 5	–	470	\pm 50	B59421A0105A062		
0402	115 \pm 5	–	470	\pm 50	B59421A0115A062		
0402	125 \pm 5	–	470	\pm 50	B59421A0125A062		
0402	135 \pm 5	–	470	\pm 50	B59421A0135A062		
0603	85 \pm 5	100 \pm 7	470	\pm 50	B59641A0085A062		
0603	95 \pm 5	110 \pm 7	470	\pm 50	B59641A0095A062		
0603	105 \pm 5	120 \pm 7	470	\pm 50	B59641A0105A062		
0603	115 \pm 5	130 \pm 7	470	\pm 50	B59641A0115A062		
0603	125 \pm 5	140 \pm 7	470	\pm 50	B59641A0125A062		
0603	135 \pm 5	150 \pm 7	470	\pm 50	B59641A0135A062		
0603	145 \pm 5	–	470	\pm 50	B59641A0145A062		
Superior series, case size 0805							
EIA case size	$T_{\text{sense},1}$ [°C]	R_R ($V \leq V_{\text{max}}$) [Ω]	ΔR_R [%]	R ($T_{\text{sense},1} - 5^\circ\text{C}$) [k Ω]	R ($T_{\text{sense},1} + 5^\circ\text{C}$) [k Ω]	R ($T_{\text{sense},1} + 15^\circ\text{C}$) [k Ω]	Ordering code
0805	70	680	\pm 50	≤ 5.7	≤ 5.7	–	B59721A0070A062
0805	80	680	\pm 50	≤ 5.7	≤ 5.7	–	B59721A0080A062
0805	90	680	\pm 50	≤ 5.5	≤ 13.3	≥ 40	B59721A0090A062
0805	100	680	\pm 50	≤ 5.5	≤ 13.3	≥ 40	B59721A0100A062
0805	110	680	\pm 50	≤ 5.5	≤ 13.3	≥ 40	B59721A0110A062
0805	120	680	\pm 50	≤ 5.5	≤ 13.3	≥ 40	B59721A0120A062
0805	130	680	\pm 50	≤ 5.5	≤ 13.3	≥ 40	B59721A0130A062

Important information: Some parts of this publication contain statements about the suitability of our products for certain areas of application. These statements are based on our knowledge of typical requirements that are often placed on our products. We expressly point out that these statements cannot be regarded as binding statements about the suitability of our products for a particular customer application. It is incumbent on the customer to check and decide whether a product is suitable for use in a particular application. This publication is only a brief product survey which may be changed from time to time. Our products are described in detail in our data sheets. The *Important notes* (www.epcos.com/ImportantNotes) and the product-specific *Cautions and warnings* must be observed. All relevant information is available through our sales offices.

Dimensional drawings in mm

EIA case size 0402

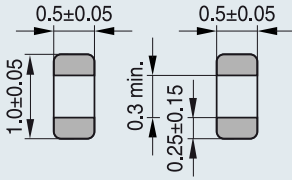

Termination

TPT0948-M-E

Solder pad

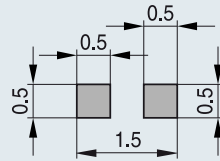

TPT0949-V

Recommended maximum dimensions

EIA case size 0603

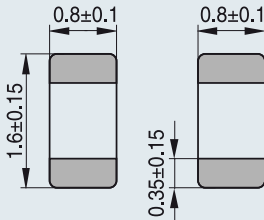

Termination

TPT0698-5-E

Solder pad

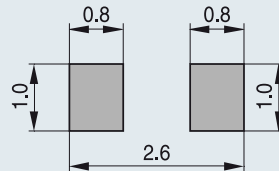

TPT0899-A

Recommended maximum dimensions

EIA case size 0805

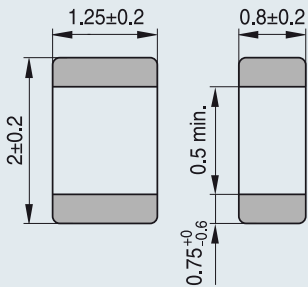

Termination

TPT0650-F-E

Solder pad

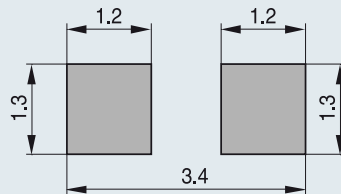

TPT0870-7

Recommended maximum dimensions

