

M3PRC/S-4W

Phase Failure Relay Over and Under Voltage plus Time Delay • Relais de défaillance de phase - Sur / sous-voltage plus délai de temps
 Phasenausfalls - Relais Über / Unterspannung plus Zeitverzögerung • Relé guasti di fase sopra / sottotensione più avviamento ritardato

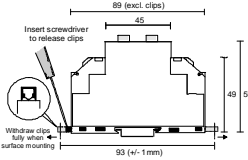

MOUNTING DETAILS
INSTRUCTIONS DE MONTAGE
MONTAGEANLEHRUNGEN
ISTRUZIONI DI MONTAGGIO



Width / largeur / Breite / Largh. 35 mm (DIN 43880)

- ❑ INCORRECT PHASE SEQUENCE ROTATION
- ❑ PHASE FAILURE / LOSS
- ❑ NEUTRAL LOSS
- ❑ UNDER VOLTAGE - ADJUSTABLE TRIP LEVEL
- ❑ OVER VOLTAGE - ADJUSTABLE TRIP LEVEL
- ❑ DELAY FROM FAULT - ADJUSTABLE

- ❑ SÉQUENCE DE PHASE INCORRECTE
- ❑ DÉFAILLANCE DE PHASE / PERTE
- ❑ PERTE NEUTRE
- ❑ SOUS-VOLTAGE - NIVEAU DE DÉPLACEMENT ADJUSTABLE
- ❑ SUR-VOLTAGE - NIVEAU DE DÉPLACEMENT ADJUSTABLE
- ❑ DÉLAI DE DÉFAILLANCE - ADJUSTABLE

- ❑ FALSCHER PHASENFOHLE / UMLAUF
- ❑ PHASENAUSFALL / VERLUST
- ❑ VERLUST NEUTRAL
- ❑ UNTERSANNUNG - NIVEAUVERSCHIEBUNG VERSTELLBAR
- ❑ ÜBERSANNUNG - NIVEAUVERSCHIEBUNG VERSTELLBAR
- ❑ FEHLERHAFTE VERZÖGERUNG - VERSTELLBAR

- ❑ SEQUENZA DI FASE ERRATA / ROTAZIONE
- ❑ GUASTO DI FASE / PERDITA
- ❑ PERDITA NEUTRO
- ❑ SOTTOTENSIONE - LIVELLO DI SCATTO AUTOMATICO REGOLABILE
- ❑ SOVRATENSIONE - LIVELLO DI SCATTO AUTOMATICO REGOLABILE
- ❑ RITARDO DA GUASTO - REGOLABILE

• INSTALLATION AND SETTING

 Installation work must be carried out by qualified personnel.

- BEFORE INSTALLATION, ISOLATE THE SUPPLY.
- Connect the unit as shown in the diagram above.
- Set 'over trip level' and 'under trip level'.
- Apply power (green LED on, red LED on, contacts 15 and 18 closed).

Troubleshooting

- Check wiring and voltage present.
- Check neutral connection.
- If incorrect sequence.
- Reverse any 2 phases.

• MONTAGE ET MISE AU POINT

 Des travaux d'installation doivent être menés à bien par le personnel qualifié.

- AVANT MONTAGE, ISOLER L' ALIMENTATION
- Branchement comme indiqué dans le diagramme ci-dessus.
- Régler les niveaux de déplacement au-dessus et au-dessous.
- Appliquer la puissance (LED verte allumée, LED rouge allumée, contacts 15 et 18 fermés).

Intervention (pour régler un problème)

- Vérifier les fils et le voltage présent.
- Vérifier la connection neutre.
- Si séquence incorrecte.
- Inverser 2 phases.

• EINBAU UND EINSTELLUNG

 Installation Arbeit muß von qualifiziertem Personal durchgeführt werden.

- VOR EINBAU DIE STROMVERSORGUNG ISOLIEREN
- Stromversorgung anschliessen wie im Schaltbild unten angezeigt.
- Einstellung der unter - und über Standverschiebung.
- Energie anbringen (LED grün an, LED rot an, Kontakte 15 und 18 geschlossen).

Störungsbehebung

- Überprüfung von Leitungen und gegenwärtiger Spannung.
- Überprüfung von Sternpunkt verbindung.
- Folgefehler.
- 2 Phasen umschalten.

• MONTAGGIO E REGOLAZIONE

 Il lavoro dell'installazione deve essere effettuato dai personali qualificati.

- PRIMA DELL'INSTALLAZIONE, ISOLARE L'ALIMENTAZIONE
- Collegare l'unità come illustrato nel diagramma in alto.
- Impostare il "livello superiore di scatto automatico" e il "livello inferiore di scatto automatico".
- Applicare la potenza (LED verde acceso, LED rosso acceso, contatti 15 e 18 chiusi).

Localizzazione guasti

- Verificare il cablaggio e la presenza della tensione
- Verificare il collegamento neutro.
- Verificare se la sequenza è errata.
- Invertire 2 fasi.

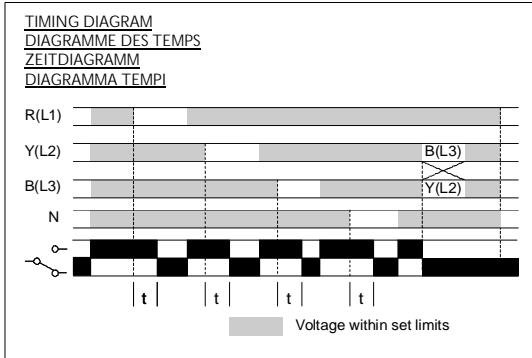

• TECHNICAL SPECIFICATION

Supply/monitoring voltage Un: (phase to phase)	220, 380, 400, 415V AC 48 - 63Hz
Supply variation:	0.75 - 1.25 x Un
Isolation:	5.55kV (supply to relay contacts)
Rated impulse withstand voltage:	4kV (1.2/50µs)
Power consumption:	< 8VA (1.25 x Un)
Upper trip level:	1.05 - 1.25 x Un
Lower trip level:	0.75 - 0.95 x Un
Hysteresis:	= 2%
Time delay (t):	0.2 - 10S (± 20%) (from fault) (N.B. worst case delay may be t x 6 @ min.)
Ambient temperature:	-20 to + 60°C
Relative humidity:	+ 95%
Contact rating:	1 x C.O. AC1 250V AC 8A (2000VA) AC15 250V AC 5A (no), 3A (nc) DC1 25V DC 8A (200W)
Electrical life:	≥ 150,000 (AC1)
Housing:	to UL94 VO
Weight:	= 112g
Mounting option:	to BS5584:1978 (EN50 002, DIN 46277-3)
Terminal conductor size:	≤ 2 x 2.5mm ² solid /stranded
Approvals:	UL, CUL, CE and  Compliant

The information provided in this literature is believed to be accurate (subject to change without prior notice); however, use of such information shall be entirely at the user's own risk

• FICHES TECHNIQUES

Voltage d'alimentation contrôlée Un: (mise en phase)	220, 380, 400, 415V AC 48 - 63Hz
Variation d'alimentation:	0.75 - 1.25 x Un
Isolement:	5.55kV (contact entre l'alimentation et le relais)
Impulsion nominale résistante à la tension:	4kV (1.2/50µs)
Puissance consommée:	< 8VA (1.25 x Un)
Niveau déclencheur supérieur:	1.05 - 1.25 x Un
inférieur:	0.75 - 0.95 x Un
Hystérèse:	= 2%
Délai de temps (t):	0.2 - 10S (± 20%) (défaillance) (N.B. le délai dans le plus mauvais cas peut être t x 6 @ min.)
Température ambiante:	-20 à + 60°C
Humidité relative:	+ 95%
Evaluation du contact:	1 x Inverseur AC1 250V AC 8A (2000VA) AC15 250V AC 5A (travail), 3A (repos) DC1 25V DC 8A (200W)
Durée de vie électrique:	≥ 150,000 (AC1)
Boîtier:	à UL94 VO
Poids:	= 112g
Option de montage:	à BS5584:1978 (EN50 002, DIN 46277-3)
Taille du conducteur ninal:	≤ 2 x 2.5mm ² toron / multi-filaire
Homologations:	UL, CUL, CE et  Déférénce

Les indications contenues dans ce document sont exactes (sous réserve de changement sans avis préalable) toutefois aux risques et périls de l'utilisateur

• TECHNISCHE DATEN

Stromversorgung / Spannungskontrolle U: (phase zu phase)	220, 380, 400, 415V AC 48 - 63Hz
Wechselversorgung:	0.75 - 1.25 x Un
Isolation:	5.55kV (Versorgung zu Relais Kontakt)
Nenn-Impulse Spannungsüberstand:	4kV (1.2/50µs)
Energieverbrauch:	< 8VA (1.25 x Un)
Standauslöser oberer:	1.05 - 1.25 x Un
unterer:	0.75 - 0.95 x Un
Hysteresis:	= 2%
Zeitsteuerung (t):	0.2 - 10S (± 20%) (Fehlsteuerung) (N.B. Die verzögerung im schlimmsten Falle kann sein t x 6 @ min.)
Umgebungstemperatur:	-20 bis + 60°C
Allgemeiner Feuchtigkeitsgehalt:	+ 95%
Kontakt Belastung:	1 x Wechsler AC1 250V AC 8A (2000VA) AC15 250V AC 5A (Schließer), 3A (Öffner) DC1 25V DC 8A (200W)
Elektrische Lebensdauer:	≥ 150,000 (AC1)
Gehäuse:	bis UL94 VO
Gewicht:	= 112g
Befestigungswahl:	bis BS5584:1978 (EN50 002, DIN 46277-3)
Anschlussklemme / Kabelgröße:	≤ 2 x 2.5mm ² Festdraht / Litze
Genehmigungen:	UL, CUL, CE und  Übereinstimmung

Es handelt sich in diesen Unterlagen um uns genau bekannte Angaben, (Änderungen vorbehalten) jedoch diese Änderungen laufen auf eigene Gefahr des Benutzers.

• SCHEDA TECNICA

Alimentazione/controllo tensione Un: (da fase a fase)	220, 380, 400, 415V AC 48 - 63Hz
Variazione alimentazione:	0.75 - 1.25 x Un
Isolamento:	5.55kV (contatto tra alimentazione e relé)
Impulso nominale resistenza alla tensione:	4kV (1.2/50µs)
Consumo energetico:	< 8VA (1.25 x Un)
Livello scatto superiore:	1.05 - 1.25 x Un
Livello scatto inferiore:	0.75 - 0.95 x Un
Isteresi:	= 2%
Avviam. ritardato (t):	0.2 - 10S (± 20%) (da guasto)
Temperatura ambiente:	da -20 a + 60°C
Umidità relativa:	+ 95%
Portata contatti:	1 x contatto in scambio AC1 250V AC 8A (2000VA) AC15 250V AC 5A (na), 3A (nc) DC1 25V DC 8A (200W)
Vita elettrica:	≥ 150,000 (AC1)
Alloggiamento:	secondo UL94 VO
Peso:	= 112g
Opzione montaggio:	secondo BS5584:1978 (EN50 002, DIN 46277-3)
Dimensioni cavo conduttore terminale:	≤ 2 x 2.5mm ² a filo pieno /a trefilo
Omologazioni:	UL, CUL, Conformità  CE

Le informazioni fornite nel presente documento sono precise (salvo modifiche senza preavviso); l'utente si assume tuttavia ogni rischio circa l'uso che ne farà.

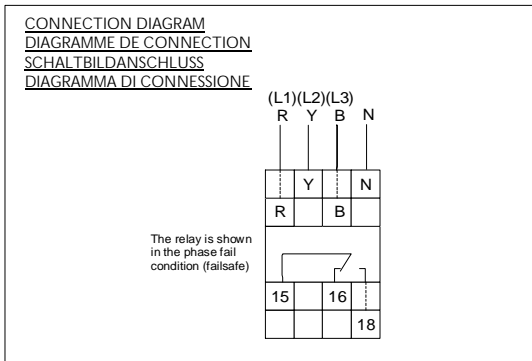

Broyce Control Ltd., Pool Street, Wolverhampton, West Midlands WV2 4HN. England ☎ +44 (0) 1902 773746 ☎ +44 (0) 1902 420639 Email: sales@broycecontrol.com Web: http://www.broycecontrol.com