

Features

- Working voltage 3.3 V
- SMT - DFN package
- Low capacitance - 4 pF
- IEC 61000-4-2 (ESD)
- IEC 61000-4-4 (EFT)
- IEC 61000-4-5 (Surge)

Applications

- FireWire, T1/E1, T3/E3 chip side protection
- Digital Visual Interface (DVI)
- Ethernet 10/100/1000 Base T
- High speed port protection
- Portable electronics

CDDFN10-3304N - TVS/Steering Diode Array

General Information

The CDDFN10-3304N device provides ESD, EFT and Surge protection for high speed data ports meeting IEC 61000-4-2 (ESD), IEC 61000-4-4 (EFT) and IEC 61000-4-5 (Surge) requirements. The Transient Voltage Suppressor array, protecting up to 4 data lines, offers a Working Peak Voltage of 3.3 V.

The DFN-10 packaged device will mount directly onto the industry standard DFN-10 footprint. Bourns® Chip Diodes are easy to handle with standard pick and place equipment and their flat configuration minimizes roll away.

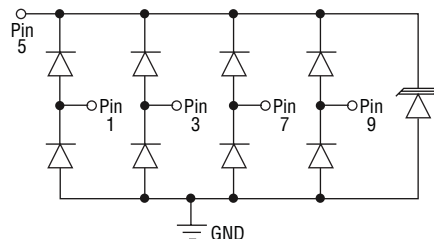

Absolute Maximum Ratings, $T_A = 25^\circ\text{C}$ (Unless Otherwise Noted)

Parameter	Symbol	CDDFN10-3304N	Unit
Peak Pulse Power ($t_p = 8/20 \mu\text{s}$) (NOTE 1)	P_{PK}	450	W
Peak Pulse Current ($t_p = 8/20 \mu\text{s}$)	I_{PP}	25	A
Storage Temperature	T_{STG}	-55 to +150	$^\circ\text{C}$
Operating Temperature	T_{OPR}	-55 to +125	$^\circ\text{C}$

Notes:

1. See Peak Pulse Power vs. Pulse Time.

Electrical Characteristics (@ $T_A = 25^\circ\text{C}$ Unless Otherwise Noted)

Parameter	Symbol	Min.	Typ.	Max.	Unit
Breakdown Voltage @ 1 mA	V_{BR}	3.9			V
Working Peak Voltage	V_{WM}			3.3	V
Leakage Current ¹ @ V_{WM}	I_D		1	5	μA
Clamping Voltage ² @ $I_P = 5 \text{ A } 8/20 \mu\text{s}$	V_C			15	V
Clamping Voltage ² @ $I_P = 15 \text{ A } 8/20 \mu\text{s}$	V_C			18	V
Clamping Voltage ² @ $I_P = 20 \text{ A } 8/20 \mu\text{s}$	V_C			20	V
Junction Capacitance ² @ 0 V 1 MHz	C_D		4.0	5.0	pF
Junction Capacitance ³ @ 0 V 1 MHz	C_{IO}		2.5		pF
ESD Protection per IEC 61000-4-2					
Contact Discharge		8		20	kV
Air Discharge		15		30	kV
EFT Protection per IEC 61000-4-4 @ 5/50 ns		40			A
Surge Protection per IEC 61000-4-5 @ 8/20 μs				25	A

Note 1: Pin 5 to ground.

Note 2: Pin 1,3,7 or 9 to ground.

Note 3: Between Pin 1,3,7 and 9.

BOURNS®

Asia-Pacific: Tel: +886-2 2562-4117 • Fax: +886-2 2562-4116

Europe: Tel: +41-41 768 5555 • Fax: +41-41 768 5510

The Americas: Tel: +1-951 781-5500 • Fax: +1-951 781-5700

www.bourns.com

*RoHS Directive 2002/95/EC Jan. 27, 2003 including annex and RoHS Recast 2011/65/EU June 8, 2011.

Specifications are subject to change without notice.

Customers should verify actual device performance in their specific applications.

CDDFN10-3304N - TVS/Steering Diode Array



Product Dimensions

This is a molded DFN10 package with lead free Nickel-Paladium-Gold (Ni/Pd/Au) on the lead frame. It has a flammability rating of UL 94V-0.

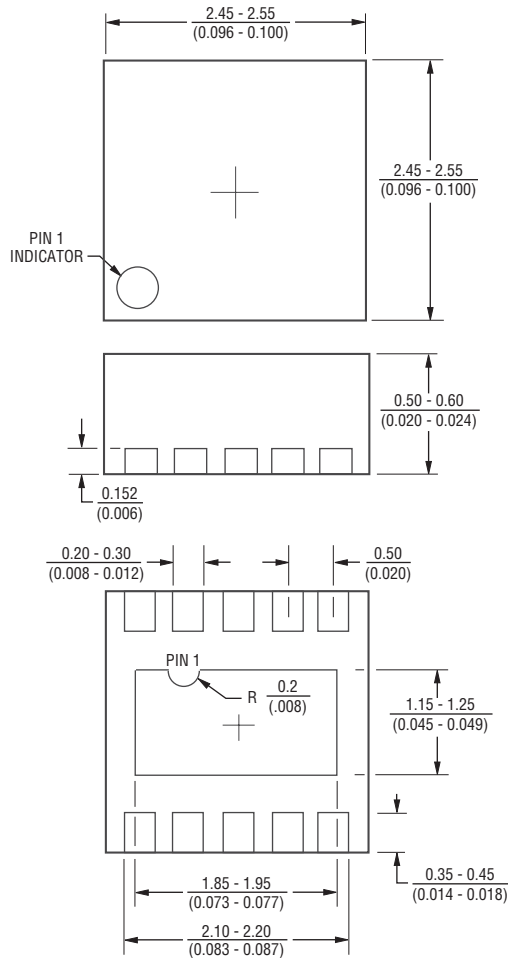

DIMENSIONS: $\frac{\text{MM}}{\text{(INCHES)}}$

Recommended Footprint

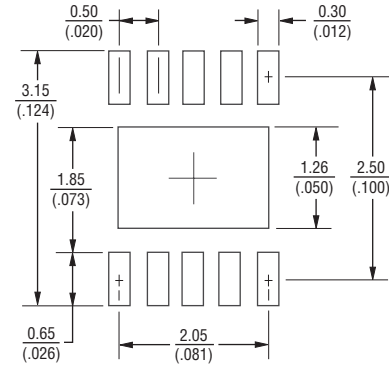

Typical Part Marking

CDDFN10-3304N334

How to Order

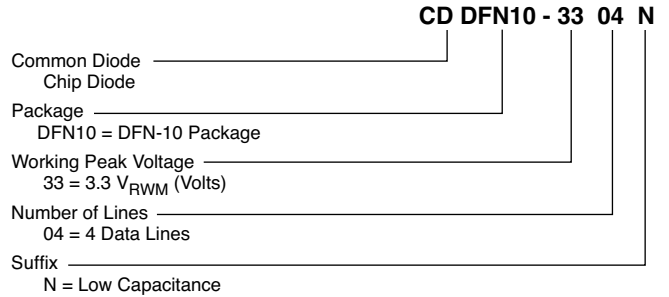

Pin Out

Pin	Function
1	I/O
2	N.C.
3	I/O
4	N.C.
5	V_{CC}
6	N.C.
7	I/O
8	N.C.
9	I/O
10	N.C.
GND	GROUND

Specifications are subject to change without notice. Customers should verify actual device performance in their specific applications.

CDDFN10-3304N - TVS/Steering Diode Array

BOURNS®

Rating & Characteristic Curves

Peak Pulse Power vs. Pulse Time

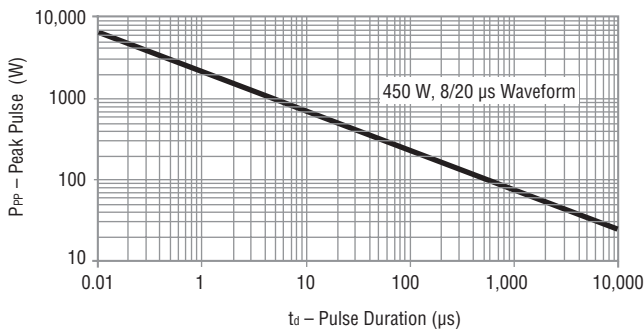

Pulse Waveform

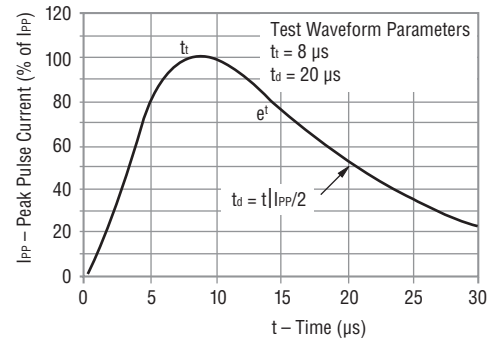

Clamping Voltage vs. Peak Pulse Current

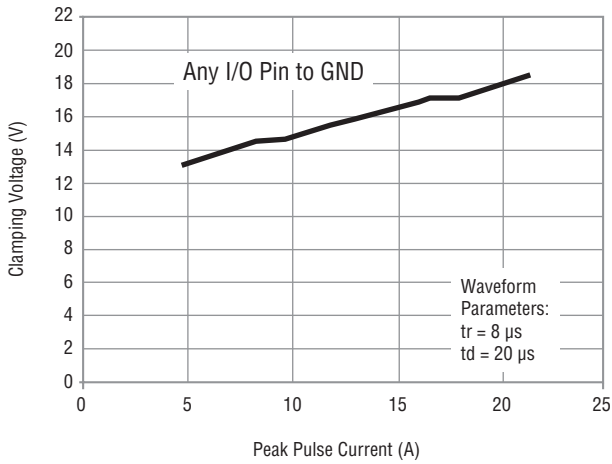

Clamping Voltage vs. Peak Pulse Current

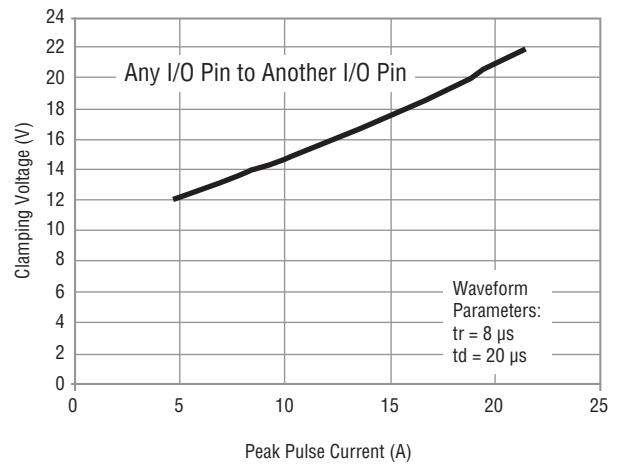

Typical Voltage vs. Capacitance

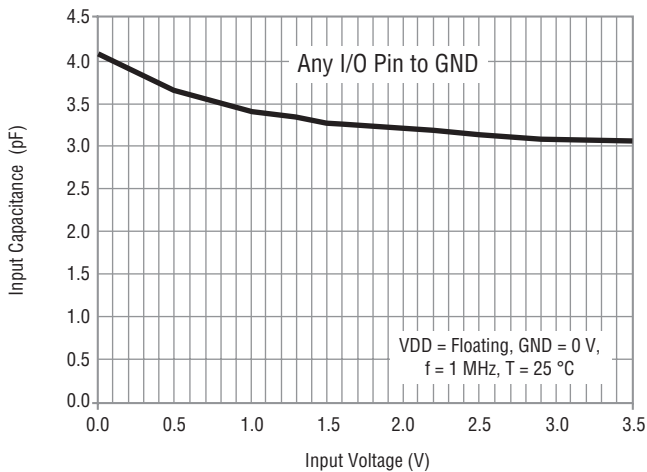

Power Derating Curve

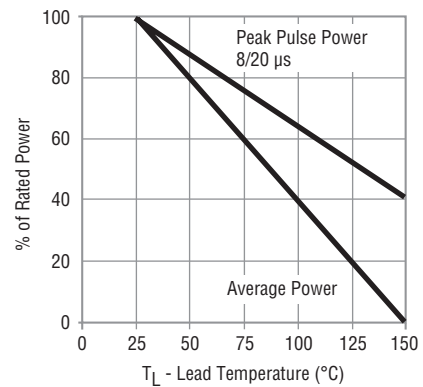

Specifications are subject to change without notice.
Customers should verify actual device performance in their specific applications.

CDDFN10-3304N - TVS/Steering Diode Array

BOURNS®

Packaging Information

The product will be dispensed in tape and reel format (see diagram below).

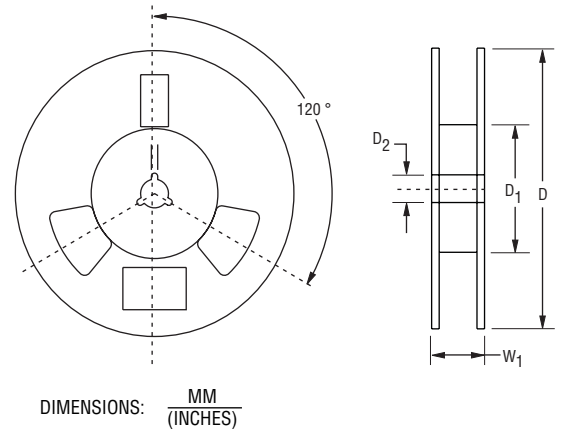
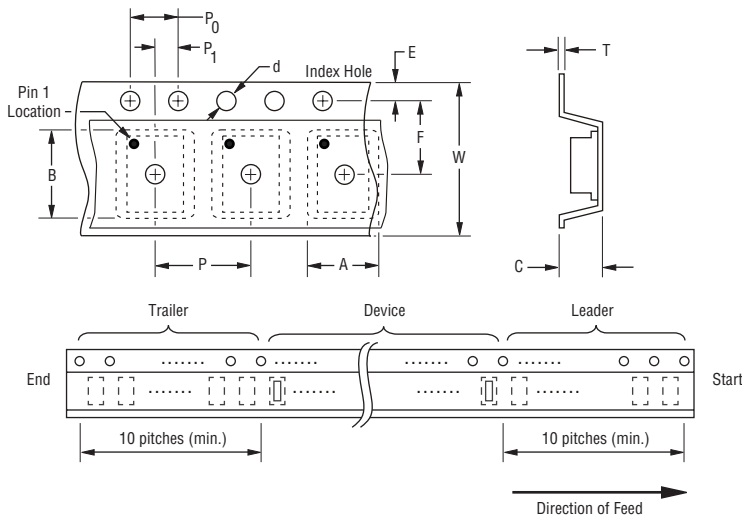

Devices are packed in accordance with EIA standard RS-481-A.

Item	Symbol	DFN-10
Carrier Width	A	$\frac{2.90 \pm 0.10}{(0.114 \pm 0.004)}$
Carrier Length	B	$\frac{2.90 \pm 0.10}{(0.114 \pm 0.004)}$
Carrier Depth	C	$\frac{0.90 \pm 0.10}{(0.035 \pm 0.004)}$
Sprocket Hole	d	$\frac{1.55 \pm 0.05}{(0.061 \pm 0.002)}$
Reel Outside Diameter	D	$\frac{178}{(7.008)}$
Reel Inner Diameter	D ₁	$\frac{50.0}{(1.969)}$ MIN.
Feed Hole Diameter	D ₂	$\frac{13.0 \pm 0.20}{(0.512 \pm 0.008)}$
Sprocket Hole Position	E	$\frac{1.75 \pm 0.10}{(0.069 \pm 0.004)}$
Punch Hole Position	F	$\frac{3.50 \pm 0.05}{(0.138 \pm 0.002)}$
Punch Hole Pitch	P	$\frac{4.00 \pm 0.10}{(0.157 \pm 0.004)}$
Sprocket Hole Pitch	P ₀	$\frac{4.00 \pm 0.10}{(0.157 \pm 0.004)}$
Embossment Center	P ₁	$\frac{2.00 \pm 0.05}{(0.079 \pm 0.002)}$
Overall Tape Thickness	T	$\frac{0.20 \pm 0.10}{(0.008 \pm 0.004)}$
Tape Width	W	$\frac{8.00 \pm 0.20}{(0.315 \pm 0.008)}$
Reel Width	W ₁	$\frac{14.4}{(0.567)}$ MAX.
Quantity per Reel	--	3000

REV. 02/12

Specifications are subject to change without notice. Customers should verify actual device performance in their specific applications.