

Tower LED

Green, 1.8mm

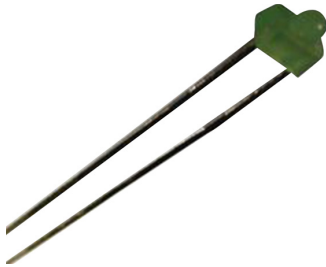

Specifications:

Dice material	: GaP
Emitted colour	: Green
Lens colour	: Green Diffused
Peak wavelength	: 568nm
Viewing angle	: 70°
Luminous intensity (IV)	: 5.8mcd

Absolute Maximum Ratings ($T_a = 25^\circ\text{C}$)

Reverse Voltage	5V
Reverse Current	10 μ A ($V_R = 5V$)
Operating Temperature Range	-40°C to +85°C
Storage Temperature Range	-40°C to +100°C
Lead Soldering Temperature Range 1.6mm (1/16 inch) from body	260°C for 5 Seconds

Electrical/Optical Characteristics at $T_a = 25^\circ\text{C}$

Parameter	Symbol	Minimum	Typical	Maximum	Unit	Test
Luminous Intensity	IV	3	5.8	8.5	mcd	IF = 20mA
Viewing Angle	2 θ 1/2	-	70	-	degrees	
Peak Emission Wavelength	λ_P	-	568	-	nm	-
Dominant Wavelength	λ_D	-	570	-		-
Spectral Line Half-Width	$\Delta\lambda$	-	30	-		-
Forward Voltage	VF	1.7	2.1	2.6	V	IF = 20mA
Power Dissipation	Pd	-	-	85	-	-
Peak Forward Current (Duty 1/10 at 1KHz)	IF (Peak)	-	-	100	-	-
Recommended Operating Current	IF (Rec)	-	20	-	mA	-

Tower LED

Green, 1.8mm



Green (GaP $\lambda_P = 568\text{nm}$)

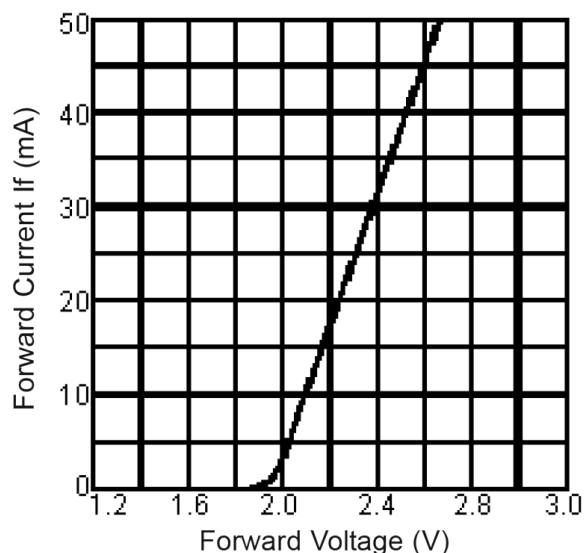

Forward Current vs. Forward Voltage

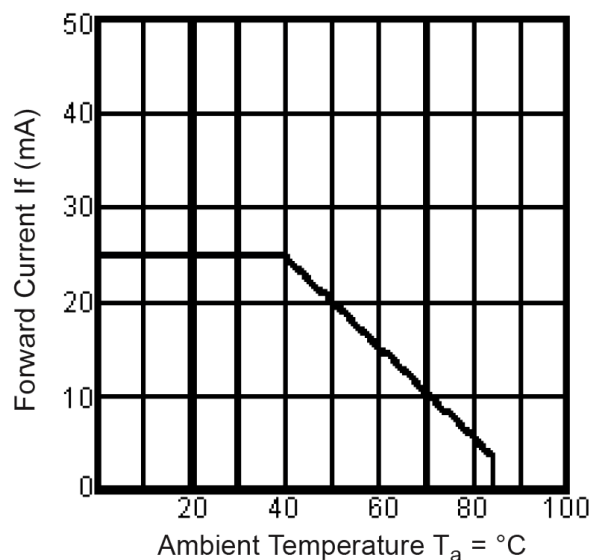

Forward Current Derating Curve

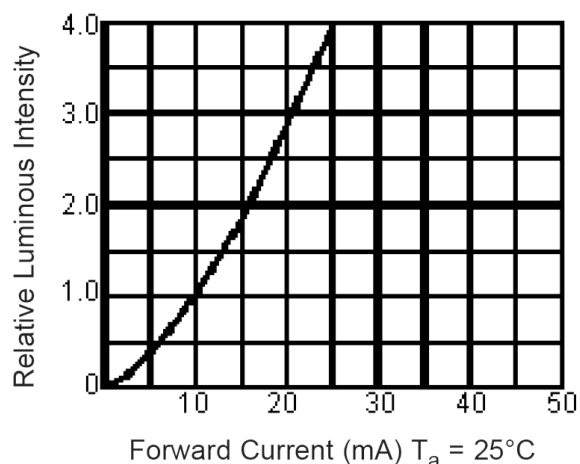

Luminous Intensity vs. Forward Current

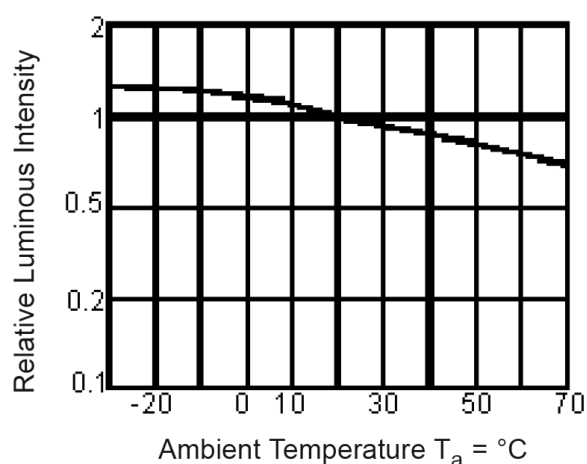

Luminous Intensity vs. Ambient Temperature



Tower LED

Green, 1.8mm

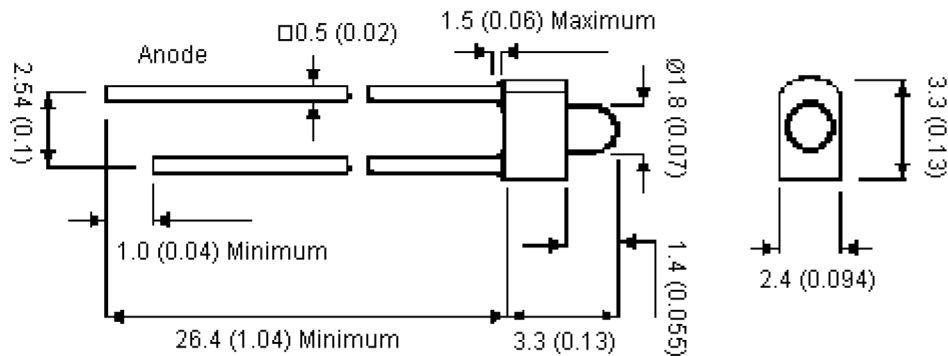
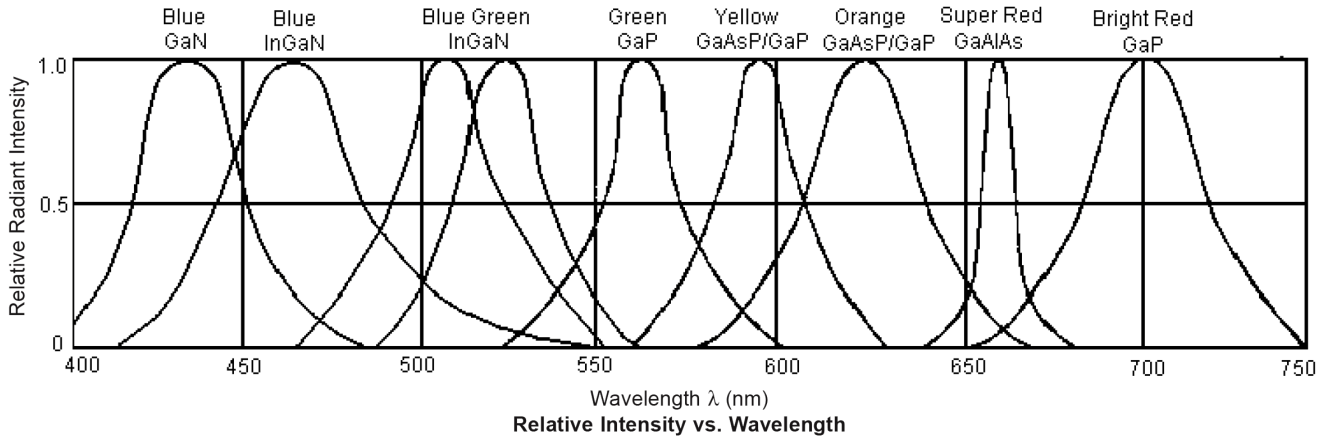

Dimensions : Millimetres (Inches)

Part Number Table

Description	Part Number
LED, 1.8mm, 76°, Green	MCL914GD

Important Notice : This data sheet and its contents (the "Information") belong to the members of the Premier Farnell group of companies (the "Group") or are licensed to it. No licence is granted for the use of it other than for information purposes in connection with the products to which it relates. No licence of any intellectual property rights is granted. The Information is subject to change without notice and replaces all data sheets previously supplied. The Information supplied is believed to be accurate but the Group assumes no responsibility for its accuracy or completeness, any error in or omission from it or for any use made of it. Users of this data sheet should check for themselves the Information and the suitability of the products for their purpose and not make any assumptions based on information included or omitted. Liability for loss or damage resulting from any reliance on the Information or use of it (including liability resulting from negligence or where the Group was aware of the possibility of such loss or damage arising) is excluded. This will not operate to limit or restrict the Group's liability for death or personal injury resulting from its negligence. Multicomp is the registered trademark of the Group. © Premier Farnell plc 2012.

www.element14.com
 www.farnell.com
 www.newark.com

