

Lithium Battery Coin Cell



Specifications:

Battery Capacity	: 270mAh (on continuous discharge at 20°C under 15kΩ load to 2V end-voltage)
Battery Voltage	: 3V
Battery Technology	: Lithium
Battery Terminals	: Flat Top
Continuous standard load	: 15KΩ
Weight	: 4.5g
Battery IEC Code	: CR2430
Standard Discharge Current	: 0.2mA
Usable Temp. Range	: -20°C to +70°C
Storage Temp. Range	: 0°C to +30°C
Storage Humidity Range	: 40% to 75%
Outer Dimensions	: ø24.5mm (+0 / -0.3) 3mm (+0 / -0.3) (Dia. Overall Height)

Terminals

Case Terminal	: SUS430+Ni-Plated
Cap Terminal	: SUS430+Ni-Plated

Discharge Characteristic

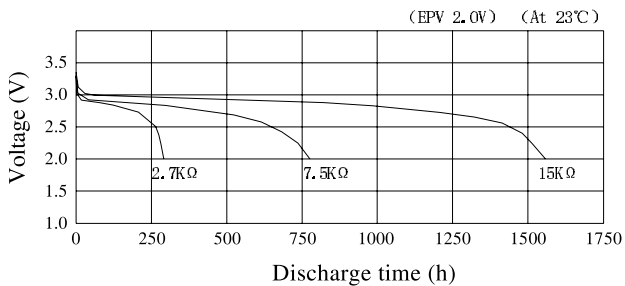

Temperature Characteristic

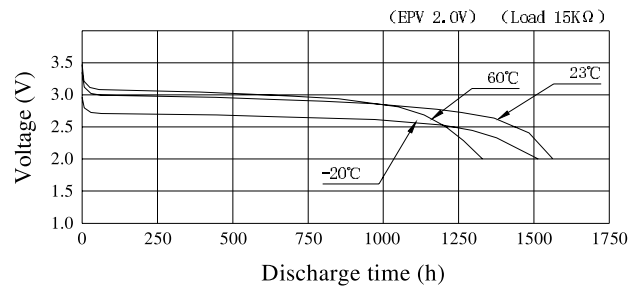

Load vs. Operating voltage

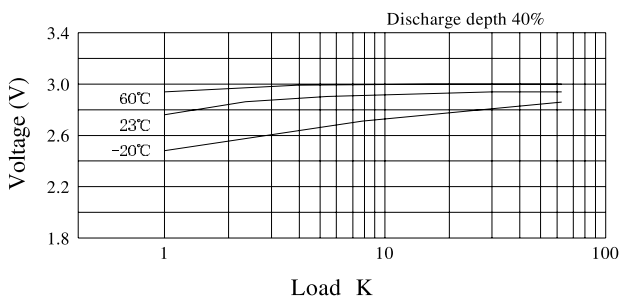

Load vs. Capacity

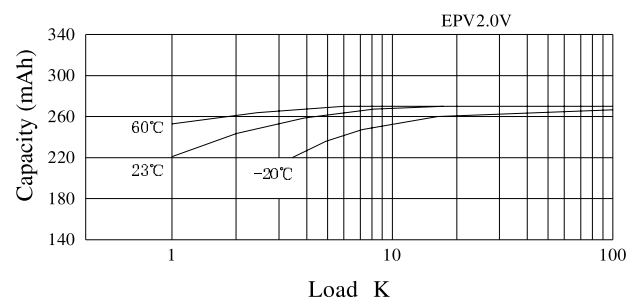

Lithium Battery Coin Cell



Pulse discharge characteristic

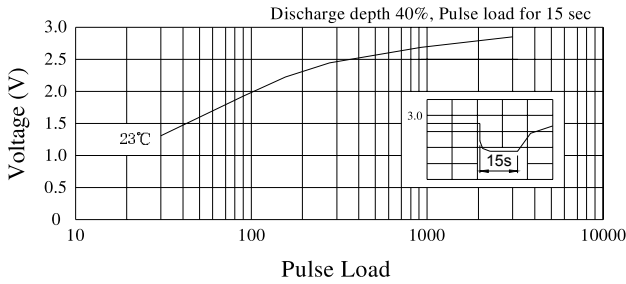

Storage characteristic

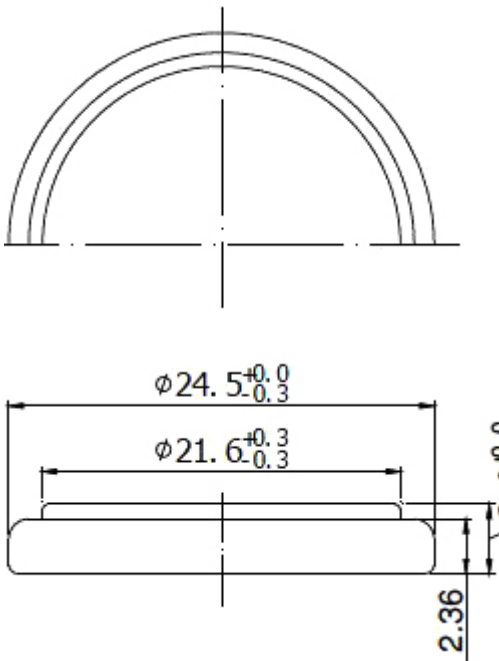
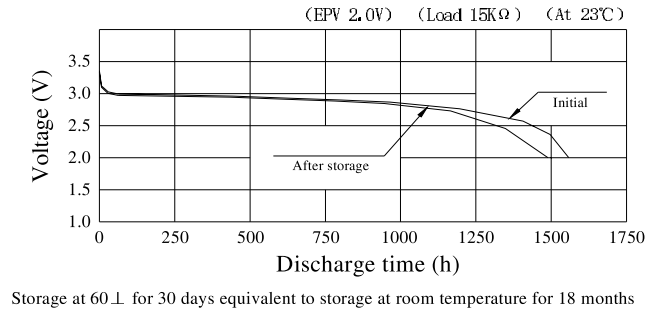

Dimension : Millimetres

Part Number Table

Description	Part Number
Coin Cell, Lithium, VERT, 270mAh	CR2430FTV12

Important Notice : This data sheet and its contents (the "Information") belong to the members of the Premier Farnell group of companies (the "Group") or are licensed to it. No licence is granted for the use of it other than for information purposes in connection with the products to which it relates. No licence of any intellectual property rights is granted. The Information is subject to change without notice and replaces all data sheets previously supplied. The Information supplied is believed to be accurate but the Group assumes no responsibility for its accuracy or completeness, any error in or omission from it or for any use made of it. Users of this data sheet should check for themselves the Information and the suitability of the products for their purpose and not make any assumptions based on information included or omitted. Liability for loss or damage resulting from any reliance on the Information or use of it (including liability resulting from negligence or where the Group was aware of the possibility of such loss or damage arising) is excluded. This will not operate to limit or restrict the Group's liability for death or personal injury resulting from its negligence. Multicomp is the registered trademark of the Group. © Premier Farnell plc 2012.

