

Contents

Page

Description of the Han-Modular® system	06. 02
Summary Han-Modular®	06. 03
Han-Modular® Compact	06. 06
Han-Modular® Twin	06. 08
Han-Modular® Hinged frames	06. 10
Han® 200 A module	06. 12
Han® 100 A module	06. 14
Han® 70 A module	06. 18
Han® 40 A module	06. 20
Han® C Axial screw module	06. 22
Han® C module Crimp terminal	06. 24
Han® CC Protected module	06. 26
Han® CD module	06. 28
Han E® module	06. 30
Han® EE module	06. 32
Han® EE module Quick Lock termination	06. 34
Han E® Protected module	06. 36
Han® EEE module	06. 38
Han® ES module	06. 40
Han® HV module	06. 42
Han DD® module	06. 44
Han® DDD module	06. 46
Han® High Density module	06. 48
Han® D-Sub module	06. 50
Han® USB module	06. 52
Han® FireWire module	06. 54
Han® RJ45 module	06. 56
Han® GigaBit module	06. 58
Han-Quintax® module	06. 62
Han® Coax module	06. 64
Han® Multi Contact module acc. to DIN 41 626	06. 66
Han® Multi Contact module acc. to D-Sub	06. 68
Han® Pneumatic module	06. 70
Han® SC module	06. 74
Han-Elisa®	06. 76
Han-Elisa® Pt100 module	06. 78
Han-Elisa® Output module	06. 80
Han-Elisa® ID module	06. 82
Han-Modular® Accessories	06. 84

Description of the Han-Modular® system

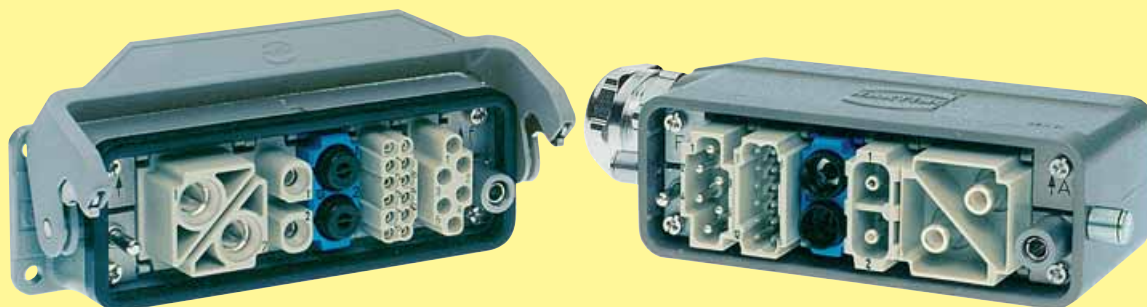

The Han-Modular® series is a new system of inserts designed to meet the specific requirements of individual customers. In close cooperation with potential users a range of modular inserts have been developed allowing the simple assembly of custom designed complete connectors which meet the diverse requirements encountered by designers today.

Han-Modular® is a logical development of the Han-Com® series which already offers the combination of power and signal circuits in one connector.

The individual modules of this series now allow the integration of electrical, optical and gaseous signal and power connections in one connector assembly.

The pneumatic contacts are also suitable for the connection of liquid media. However it must be stated that a combination of electrical and liquid connections in one connector is not allowed according to VDE regulations.

The individual contacts used in this system are all from existing well proven ranges and it is possible to use combinations of 1 to 12 modules depending on the size of the hoods and housings chosen.

The basic modules snap into a mounting frame and can be exchanged separately at any time.

Advantages:

- Custom designs can be simply assembled
- Optimum solutions can be reached
- Stock can be minimized

Assembly details

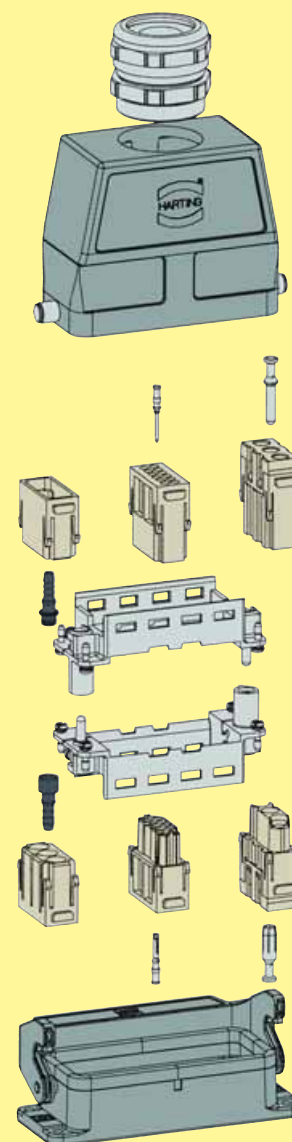



Han-Modular® Compact



Page 06.06

Han-Modular® Twin



Page 06.08

Han-Modular® Hinged frames in Han® B hoods and housings







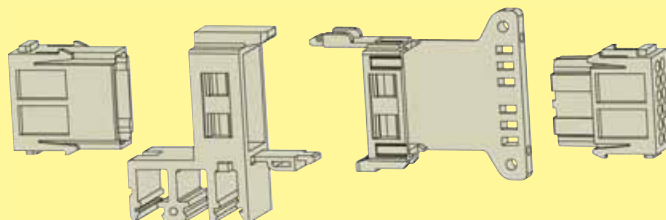









Page 06.10

Module clamps



Page 06.84

Series	Han® 200 A module	Han® 100 A module	Han® 100 A module	Han® 70 A module
Number of contacts	1	2	2	2
Modules	Axial screw terminal 	Axial screw terminal 	Crimp terminal 	Axial screw terminal 
Rated current	200 A	100 A	100 A	70 A
Rated voltage	1000 V	1000 V	1000 V	1000 V
Wire gauge	25 - 70 mm ²	10 - 38 mm ²	16 - 35 mm ²	6 - 22 mm ²
Page	06.12	06.14	06.16	06.18
Series	Han® 40 A module	Han® C Axial screw module	Han® C module	Han® CC Protected module
Number of contacts	2	3	3	4
Modules	Axial screw terminal 	Axial screw terminal 	Crimp terminal 	Crimp terminal 
Rated current	40 A	40 A	40 A	40 A
Rated voltage	1000 V	690 V	400 / 690 V	830 V
Wire gauge	2.5 - 10 mm ²	2.5 - 10 mm ²	1.5 - 10 mm ²	1.5 - 6 mm ²
Page	06.20	06.22	06.24	06.26
Series	Han® CD module	Han E® module	Han® EE module	Han® EE module
Number of contacts	3 / 4	6	8	8
Modules	Crimp terminal 	Crimp terminal 	Crimp terminal 	Quick Lock termination 
Rated current	40 A / 10 A	16 A	16 A	16 A
Rated voltage	830 V / 830 V	500 V	400 V	400 V
Wire gauge	1.5 - 6 mm ² / 0.14 - 2.5 mm ²	0.5 - 4 mm ²	0.5 - 4 mm ²	0.5 - 2.5 mm ²
Page	06.28	06.30	06.32	06.34
Series	Han E® Protected module	Han® EEE module	Han® ES module	Han® HV module
Number of contacts	6	20	5	2
Modules	Crimp terminal 	Crimp terminal 	Cage-clamp terminal 	Crimp terminal 
Rated current	16 A	16 A	16 A	16 A
Rated voltage	830 V	500 V	400 V	2900 / 5000 V
Wire gauge	0.5 - 4 mm ²	0.5 - 4 mm ²	0.14 - 2.5 mm ²	0.5 - 4 mm ²
Page	06.36	06.38	06.40	06.42

Series	Han DD® module		Han® DDD module		Han® High Density module		Han® D-Sub module	
Number of contacts	12		17		25		9	
Modules	Crimp terminal		Crimp terminal		Crimp terminal		Crimp terminal	
Rated current	10 A		10 A		4 A		5 A	
Rated voltage	250 V		160 V		50 V		50 V	
Wire gauge	0.14 - 2.5 mm ²		0.14 - 2.5 mm ²		0.08 - 0.52 mm ²		0.08 - 0.52 mm ²	
Page	06.44		06.46		06.48		06.50	
Series	Han® USB module		Han® FireWire module		Han® RJ45 module		Han® GigaBit module	
Number of contacts	4		6		8		8	
Modules	USB 2.0		IEEE 1394		Ethernet Cat 5e		Ethernet Cat 6	
Page	06.52		06.54		06.56		06.58	
Series	Han-Quintax® module				Han® Multi Contact module			
Number of contacts	2				4			
Modules								
Page	06.62		06.64		06.66		06.68	
Contacts	Quintax contact 4 + shielding	High Density Quintax contact 8 + shielding	Han D® D Coax contact 1 + shielding	Han E® E Coax contact 1 + shielding	FOC contacts	Coaxial contact		
			75 Ω	50 Ω	Multimode F.O. HCS®/PCF F.O. 1 mm POF	50 Ω RG 174 75 Ω RG 179 50 Ω RG 58		
Series	Han® Pneumatic module		Han® SC module		Han-Elisa®			
Number of contacts	2		3		4			
Modules								
Page	06.70		06.72		06.76			
Contacts	Pneumatic Contacts		SC contact		Temperature I/O modules ID module			
	∅ 6.0 mm		∅ 1.6 mm ∅ 3.0 mm ∅ 4.0 mm					

* HCS®=Hard Clad Silica (is registered trade mark of the SpecTran Corporation)

Features

- Compact design saves space
- Modular structure increases flexibility
- Simple and quick assembly
- Robust design
- Two part grommet housing

Technical characteristics

Hoods/Housings

Material	zinc die-cast
Surface	nickel plated
Locking element	stainless steel
Hoods/Housings sealing	NBR
Limiting temperatures	-40 °C ... +125 °C
Degree of protection acc. to DIN EN 60 529	
for coupled connector	IP 65
Mechanical working life	
- mating cycles	500
PE contact	
wire gauge	10 mm ² / AWG 8
Stripping length	10 mm
Tightening torque	1 Nm

Protection covers

Material	polycarbonate
Locking element	Polyamide
Hoods/Housings sealing	NBR
Limiting temperatures	-40 °C ... +125 °C
Degree of protection acc. to DIN EN 60 529	
for coupled connector	IP 65
Flammability acc. to UL 94	V 0

Current carrying capacity

The current carrying capacity of the connectors is limited by the thermal load capability of the contact element material including the connections and the insulating parts. The derating curve is therefore valid for currents which flow constantly (non-intermittent) through each contact element of the connector evenly, without exceeding the allowed maximum temperature.

Measuring and testing techniques according to DIN EN 60 512-5

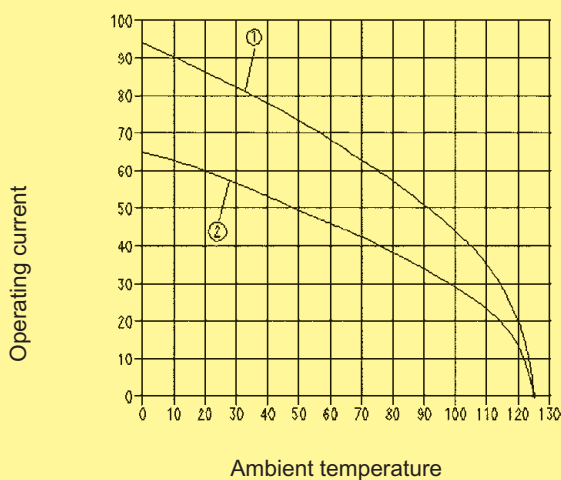

① Han® Axial screw module, Wire gauge: 10 mm²

② Han® C module, Wire gauge: 6 mm²

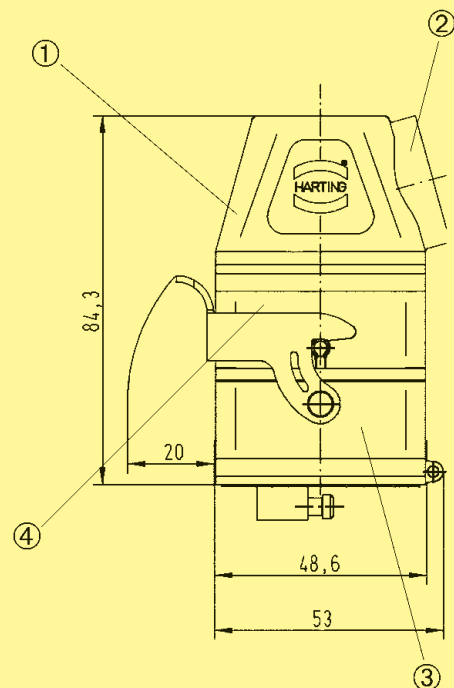

① Hood with side entry

② Thread M25

③ Bulkhead mounted housing with locking lever

④ Carrier hood

Identification	Part number	Drawing	Dimensions in mm
Hoods side entry M 25	19 14 001 0501	4 screws are included in the delivery range 	
Hoods top entry M 25	19 14 001 0401	4 screws are included in the delivery range 	
Hoods top entry M 32	19 14 001 0402	4 screws are included in the delivery range 	
Carrier hood	09 14 001 0311		
Protection covers	09 14 001 5402		
Housings, bulkhead mounting	09 14 001 0301		Panel cut out
Protection covers	09 14 001 5401		

Features

- Compact and space saving
- High degree of flexibility due to modular assembly
- Easy and quick assembly
- Robust design
- Hood consists of two parts

Technical characteristics





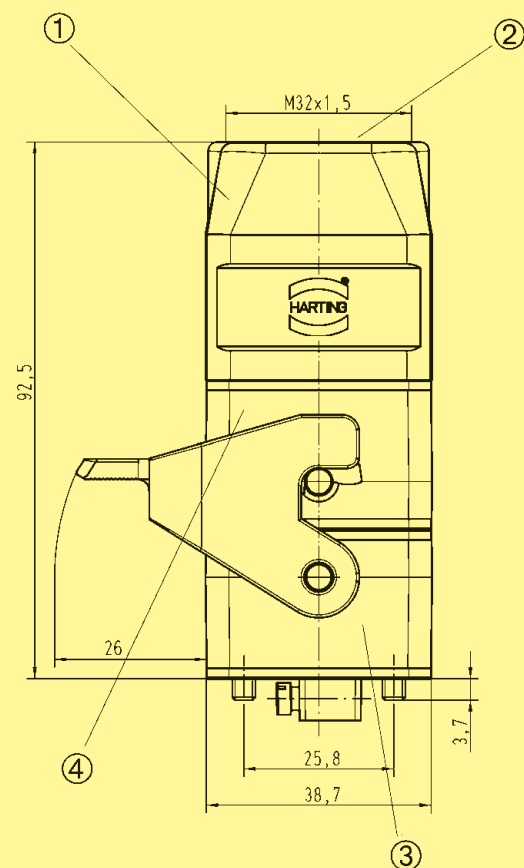

Hoods/Housings

Material	aluminium die-cast
Surface	powder-coated
Locking element	Han-Easy Lock®
Hoods/Housings sealing	NBR
Limiting temperatures	-40 °C ... +125 °C
Degree of protection acc. to DIN EN 60 529	
for coupled connector	IP 65
Mechanical working life	
- mating cycles	≥ 500
PE contact	
wire gauge	10 mm ² / AWG 8
Stripping length	10 mm
Tightening torque	1 Nm

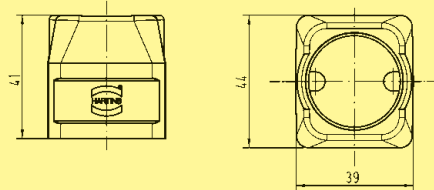
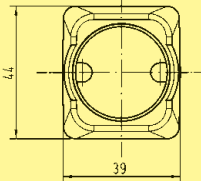

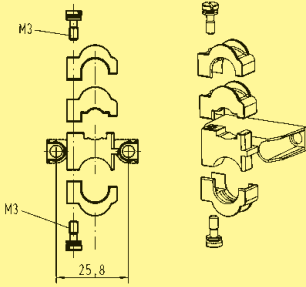
- ① Hood with top entry
- ② Thread M32
- ③ Bulkhead mounted housing with locking lever
- ④ Carrier hood

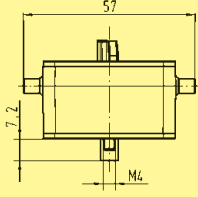
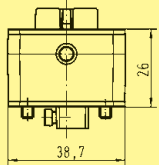

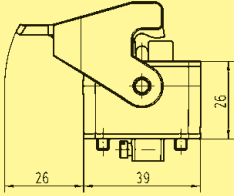
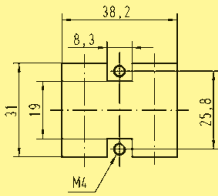
Identification	Part number	Drawing	Dimensions in mm
<p>Hoods</p> <p>top entry M 32</p> 	<p>19 14 002 0402</p>		
<p>Shielding frame</p> 	<p>09 14 000 9924</p>		
<p>Carrier hood</p> 	<p>09 14 002 0311</p>		
<p>Housings, bulkhead mounting</p> 	<p>09 14 002 0301</p>		<p>Panel cut out</p> 

Features

- Pre-leading grounding system according VDE
- Modules can only be assembled polarized to guarantee a correct orientation
- Alphabetical marking of module position
- High mechanical reliability of modules in case of vibration and impact stress
- No tools necessary to remove modules

Technical characteristics

Specifications DIN EN 60 664-1
DIN EN 61 984

Approvals  

Hinged frames

Number of modules 2, 3, 4, 6
PE contact
wire gauge
 - Power side 4 - 6 mm² (10 mm²)*
 AWG 12 - 10 (AWG 8)*
 - Signal side 1 - 2.5 mm²
 AWG 18 - 14
Material zinc die-cast
Limiting temperatures -40 °C ... +125 °C
Mechanical working life
 - mating cycles ≥ 500







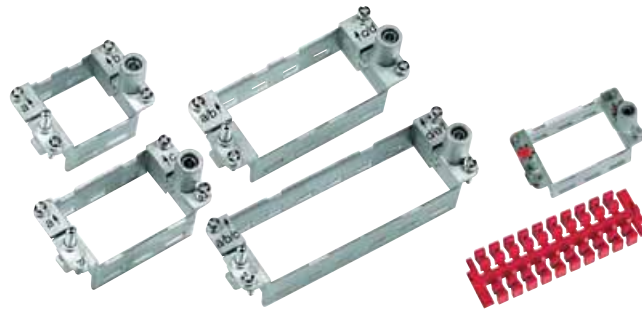

Hoods/Housings

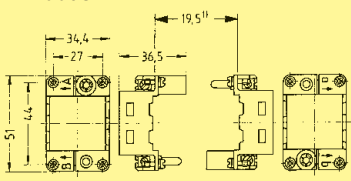
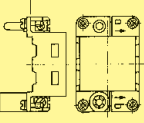
Selection of hoods/housings see chapter 30 / chapter 31
Material aluminium die-cast
Surface powder-coated
 RAL 7037
Locking element Han-Easy Lock®
Hoods/Housings sealing NBR
Limiting temperatures -40 °C ... +125 °C
Degree of protection acc. to DIN EN 60 529
for coupled connector IP 65

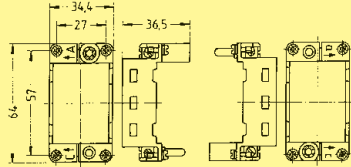
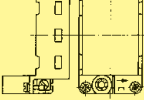
Accessories

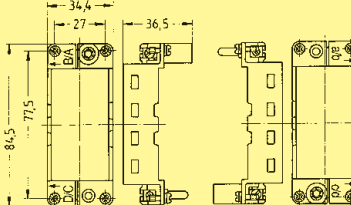
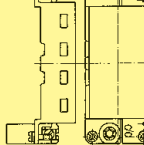
Coding of hoods/housings chapter 40

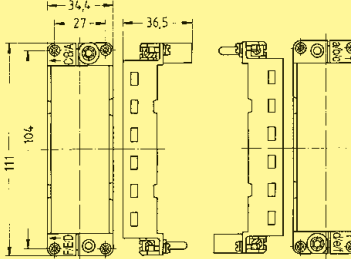
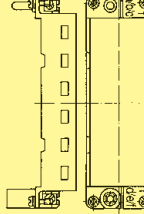
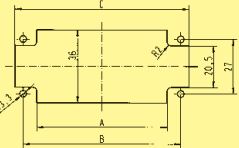

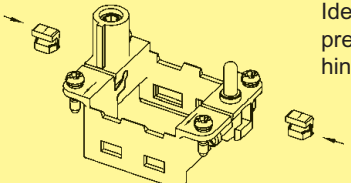
Identification	Part number for Hood/Housing 2)			Drawing	Dimensions in mm
	Size	Marking A ... F	Marking a ... f		
Hinged frame for 2 modules 	6 B	09 14 006 0303	09 14 006 0313	Hoods 	Housings 
Hinged frame for 3 modules 	10 B	09 14 010 0303	09 14 010 0313		
Hinged frame for 4 modules 	16 B	09 14 016 0303	09 14 016 0313		
Hinged frame for 6 modules 	24 B	09 14 024 0303	09 14 024 0313		 Panel cut out 
Locking element for hinged frames (20 pieces per bloc) 		09 14 000 9960	09 14 000 9960		Ideal to pre-assemble the hinged frames

Size	A	B	C
6 B	35	44	52
10 B	49	57	66
16 B	64	77.5	85.5
24 B	94	104	112

1) Distance for electrical and F.O. contacts max. 21 mm; for pneumatic contacts max. 20.5 mm
 2) Hinged frames can be used either in hood or housing
 Both different markings must be used for one connector!

Stock items in bold type

Features

- Axial-screw termination
- No special tools required
- Power module for big wire gauge up to 70 mm²
- Suitable as a 3 + PE connector in a Han® 32 B housing

Technical characteristics

Specifications DIN EN 60 664-1
 DIN EN 61 984

Approvals

Inserts

Number of contacts 1
 Electrical data
 acc. to EN 61 984 **200 A 1000 V 8 kV 3**
 Rated current 200 A
 Rated voltage 1000 V
 Rated impulse voltage 8 kV
 Pollution degree 3

Rated voltage
 acc. to UL 600 V
 Insulation resistance ≥ 10¹⁰ Ω
 Material polycarbonate
 Limiting temperatures -40 °C ... +125 °C
 Flammability acc. to UL 94 V 0
 Mechanical working life
 - mating cycles ≥ 500

Contacts

Material copper alloy
 Surface
 - hard-silver plated 3 μm Ag
 Contact resistance 0.2 mΩ
 Screw terminal
 - Wire gauge 1) 25 ... 70 mm²
 - AWG 2 ... 00
 - Hexagonal driver SW 5
 - Stripping length 16 mm
 - Tightening torque

mm ²	25	35	50	70
Nm	8	8	9	10

Current carrying capacity

The current carrying capacity of the connectors is limited by the thermal load capability of the contact element material including the connections and the insulating parts. The derating curve is therefore valid for currents which flow constantly (non-intermittent) through each contact element of the connector evenly, without exceeding the allowed maximum temperature.

Measuring and testing techniques according to DIN EN 60 512-5

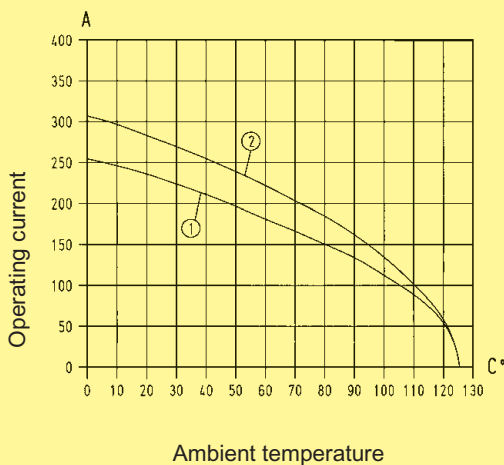

① 24 B hoods/housings with 3 modules; wire gauge: 50 mm²

② 24 B hoods/housings with 3 modules; wire gauge: 70 mm²

1) geometric wire gauge

Number of contacts

1

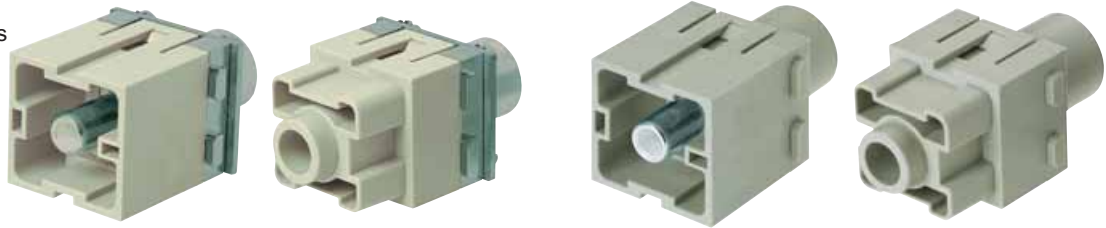

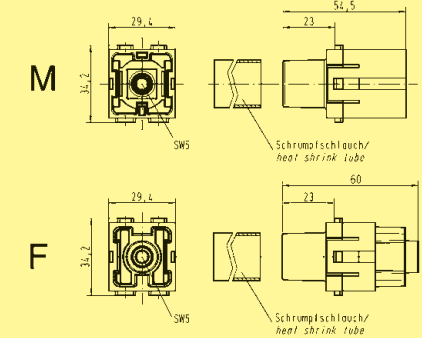
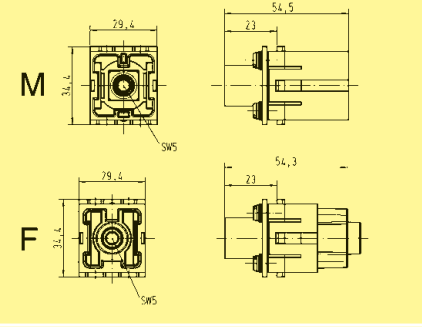
Identification	Part number		Drawing	Dimensions in mm
	Male insert (M)	Female insert (F)		
Axial screw terminal 200 A				
25 ... 40 mm ²	09 14 001 2663	09 14 001 2763		
40 ... 70 mm ²	09 14 001 2662	09 14 001 2762		
Axial screw terminal 200 A PE (Ground)				
25 ... 40 mm ²	09 14 001 2668	09 14 001 2768		
40 ... 70 mm ²	09 14 001 2667	09 14 001 2767		

Han
Modular

Identification	Part number	Drawing	Dimensions in mm
Hex key SW 5 for axial setscrew			
with grip	09 99 000 0364		
adapter 3/8"	09 99 000 0371		



Features

- Axial-screw termination
- No special tools required
- Connect PE contact with special cable shoe
- Compatible to the Han® 100 A module with crimp terminal

Technical characteristics

Specifications DIN EN 60 664-1
DIN EN 61 984

Approvals

Inserts

Number of contacts 2
 Electrical data
 acc. to EN 61 984 **100 A 1000 V 8 kV 3**
 Rated current 100 A
 Rated voltage 1000 V
 Rated impulse voltage 8 kV
 Pollution degree 3
 Pollution degree 2 also 100 A 1600 V 12 kV 2

Rated voltage
 acc. to UL 600 V
 Insulation resistance ≥ 10¹⁰ Ω
 Material polycarbonate
 Limiting temperatures -40 °C ... +125 °C
 Flammability acc. to UL 94 V 0
 Mechanical working life
 - mating cycles ≥ 500

Contacts

Material copper alloy
 Surface
 - hard-silver plated 3 μm Ag
 Contact resistance 0.3 mΩ
 Screw terminal
 - Wire gauge ¹⁾ 10 ... 38 mm²
 - AWG 6 ... 2
 - Hexagonal driver SW 4
 - Stripping length 13 mm
 - Tightening torque

mm ²	10	16	25	35
Nm	6	6	7	8

Current carrying capacity

The current carrying capacity of the connectors is limited by the thermal load capability of the contact element material including the connections and the insulating parts. The derating curve is therefore valid for currents which flow constantly (non-intermittent) through each contact element of the connector evenly, without exceeding the allowed maximum temperature.

Measuring and testing techniques according to DIN EN 60 512-5

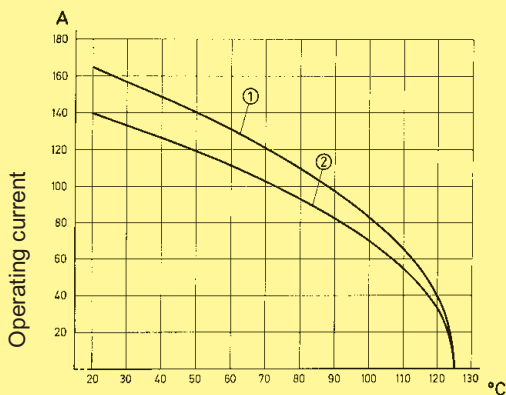

Ambient temperature

① 24 B hoods/housings with 3 modules; wire gauge: 35 mm²

② 24 B hoods/housings with 3 modules; wire gauge: 25 mm²

Number of contacts

2



Identification	Part number		Drawing	Dimensions in mm
	Male insert (M)	Female insert (F)		
Axial screw terminal 100 A				
10 ... 25 mm ²	09 14 002 2653	09 14 002 2753		
16 ... 35 mm ²	09 14 002 2651	09 14 002 2751		
38 mm ²	09 14 002 2650	09 14 002 2750		

Han
Modular

Identification	Part number	Drawing	Dimensions in mm
Hex key SW 4 for axial setscrew			
with grip	09 99 000 0363		
adapter 3/8"	09 99 000 0370		
Cable shoe 16 mm ²			
for PE extension	09 14 000 9912		<p>Please use pressing tools for non-insulated cable shoes following DIN 46 230 with 16 mm² range (eg. K25, co. Klauke)</p>

06
15

Stock items in bold type

Features

- Crimp termination
- Unlock of contacts from mating side
- Connect PE contact with special cable shoe
- Compatible to Han® 100 A module with axial screw terminal

Technical characteristics

Specifications	DIN EN 60 664-1 DIN EN 61 984
----------------	----------------------------------

Inserts

Number of contacts	2
Electrical data acc. to EN 61 984	100 A 1000 V 8 kV 3
Rated current	100 A
Rated voltage	1000 V
Rated impulse voltage	8 kV
Pollution degree	3
Pollution degree 2 also	100 A 1600 V 12 kV 2
Insulation resistance	$\geq 10^{10} \Omega$
Material	polycarbonate
Limiting temperatures	-40 °C ... +125 °C
Flammability acc. to UL 94	V 0
Mechanical working life - mating cycles	≥ 500

Contacts

Material	copper alloy
Surface	
- hard-silver plated	3 μm Ag
Contact resistance	$\leq 0.3 \text{ m}\Omega$
Crimp terminal	
- mm ²	16 ... 35 mm ²
Max. cable diameter	14 mm

Current carrying capacity

The current carrying capacity of the connectors is limited by the thermal load capability of the contact element material including the connections and the insulating parts. The derating curve is therefore valid for currents which flow constantly (non-intermittent) through each contact element of the connector evenly, without exceeding the allowed maximum temperature.

Measuring and testing techniques according to DIN EN 60 512-5

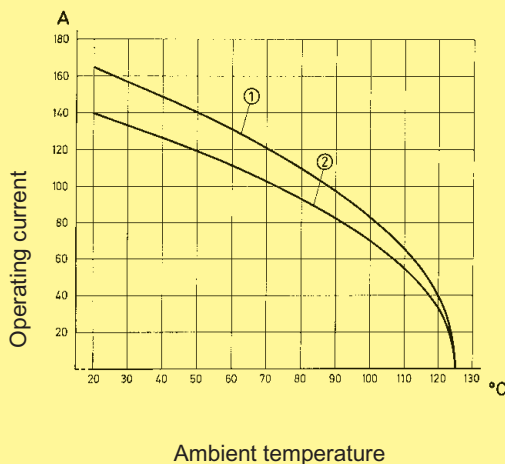

① 24 B hoods/housings with 3 modules; wire gauge: 35 mm²

② 24 B hoods/housings with 3 modules; wire gauge: 25 mm²

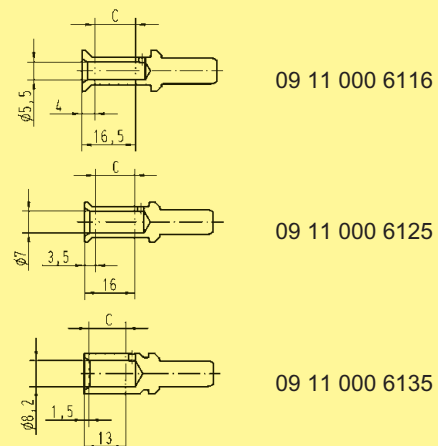

Crimp zone (C)





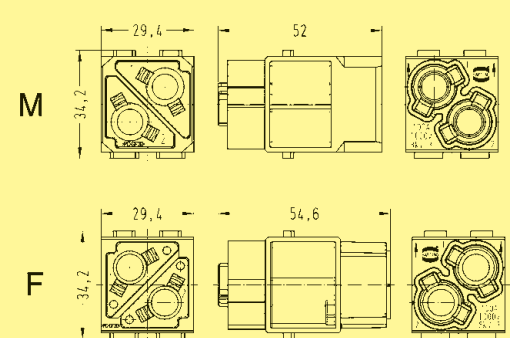

Number of contacts

2

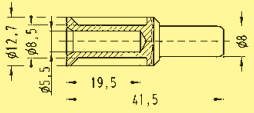
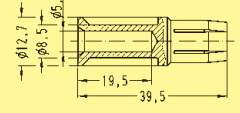

Identification	Part number		Drawing	Dimensions in mm
	Male insert (M)	Female insert (F)		
Crimp terminal Modul	09 14 002 3051	09 14 002 3151		
Removal tool for TC contacts	09 99 000 0383	09 99 000 0383		

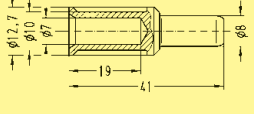
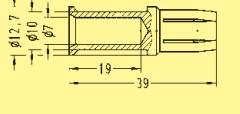
Han Modular

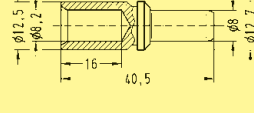
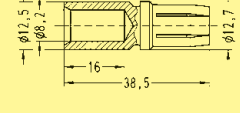
Identification	Wire gauge (mm ²)	Part number		Drawing	Dimensions in mm												
		Male contact	Female contact														
Crimp contacts silver plated																	
	16	09 11 000 6116	09 11 000 6216														
	25	09 11 000 6125	09 11 000 6225														
	35	09 11 000 6135	09 11 000 6235														
				<table border="1"> <thead> <tr> <th>Wire gauge</th> <th>∅</th> <th>Stripping length</th> </tr> </thead> <tbody> <tr> <td>16 mm²</td> <td>5.5</td> <td>19 mm</td> </tr> <tr> <td>25 mm²</td> <td>7</td> <td>19 mm</td> </tr> <tr> <td>35 mm²</td> <td>8.2</td> <td>16 mm</td> </tr> </tbody> </table>	Wire gauge	∅	Stripping length	16 mm ²	5.5	19 mm	25 mm ²	7	19 mm	35 mm ²	8.2	16 mm	
Wire gauge	∅	Stripping length															
16 mm ²	5.5	19 mm															
25 mm ²	7	19 mm															
35 mm ²	8.2	16 mm															
for stranded wire according to IEC 60 228 Class 5																	

Features

- Axial-screw termination
- 2 contacts (70 A) for power circuits
- Male inserts with protection collar
- Polarisation of module
- Male and female contacts are finger safe

Technical characteristics

Specifications DIN EN 60 664-1
DIN EN 61 984

Approvals

Inserts

Number of contacts 2
 Electrical data
 acc. to EN 61 984 **70 A 1000 V 8 kV 3**
 Rated current 70 A
 Rated voltage 1000 V
 Rated impulse voltage 8 kV
 Pollution degree 3
 Pollution degree 2 also 70 A 1600 V 12 kV 2

Rated voltage
 acc. to UL 600 V
 Insulation resistance $\geq 10^{10} \Omega$
 Material polycarbonate
 Limiting temperatures -40 °C ... +125 °C
 Flammability acc. to UL 94 V 0
 Mechanical working life
 - mating cycles ≥ 500

Contacts

Material copper alloy
 Surface
 - hard-silver plated 3 μ m Ag
 Contact resistance 0.5 m Ω
 Screw terminal
 - Wire gauge ¹⁾ 6 ... 22 mm²
 - AWG 8 ... 4
 - Hexagonal driver SW 2.5
 - Stripping length

mm ²	6	10	16	22
mm	11 ⁺¹	11 ⁺¹	11 ⁺¹	12.5 ⁺¹

- Tightening torque

mm ²	6	10	16	22
Nm	2	3	4	5

Current carrying capacity

The current carrying capacity of the connectors is limited by the thermal load capability of the contact element material including the connections and the insulating parts. The derating curve is therefore valid for currents which flow constantly (non-intermittent) through each contact element of the connector evenly, without exceeding the allowed maximum temperature.

Measuring and testing techniques according to DIN EN 60 512-5

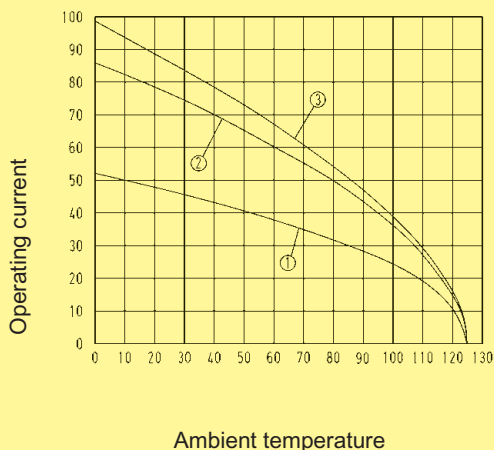

- ① 24 B hoods/housings with 6 modules; wire gauge: 6 mm²
- ② 24 B hoods/housings with 6 modules; wire gauge: 16 mm²
- ③ 24 B hoods/housings with 6 modules; wire gauge: 22 mm²

1) geometric wire gauge

Number of contacts

2

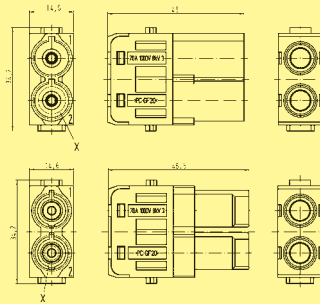

Identification	Part number		Drawing	Dimensions in mm
	Male insert (M)	Female insert (F)		
Axial screw terminal 70 A				
6 ... 16 mm ²	09 14 002 2641	09 14 002 2741		
14 ... 22 mm ²	09 14 002 2642	09 14 002 2742		

Han
Modular

Identification	Part number	Drawing	Dimensions in mm
Hex key SW 2.5 for axial setscrew			
Bit 1/4"	09 99 000 0375		



Features

- Axial-screw termination
- No special tools required

Technical characteristics

Specifications DIN EN 60 664-1
DIN EN 61 984

Approvals

Inserts

Number of contacts 2
 Electrical data
 acc. to EN 61 984 **40 A 1000 V 8 kV 3**
 Rated current 40 A
 Rated voltage 1000 V
 Rated impulse voltage 8 kV
 Pollution degree 3
 Pollution degree 2 also 40 A 1600 V 12 kV 2

Rated voltage
 acc. to UL 600 V
 Insulation resistance ≥ 10¹⁰ Ω
 Material polycarbonate
 Limiting temperatures -40 °C ... +125 °C
 Flammability acc. to UL 94 V 0
 Mechanical working life
 - mating cycles ≥ 500

Contacts

Material copper alloy
 Surface
 - hard-silver plated 3 μm Ag
 Contact resistance 0.5 mΩ
 Screw terminal
 - Wire gauge ¹⁾ 2.5 ... 10 mm²
 - AWG 14 ... 8
 - Hexagonal driver SW 2
 - Stripping length

mm ²	2.5	4	6	10
mm	5 ⁺¹	5 ⁺¹	8 ⁺¹	11 ⁺¹

- Tightening torque

mm ²	2.5	4	6	10
Nm	1.5	1.5	2	2

Current carrying capacity

The current carrying capacity of the connectors is limited by the thermal load capability of the contact element material including the connections and the insulating parts. The derating curve is therefore valid for currents which flow constantly (non-intermittent) through each contact element of the connector evenly, without exceeding the allowed maximum temperature.

Measuring and testing techniques according to DIN EN 60 512-5

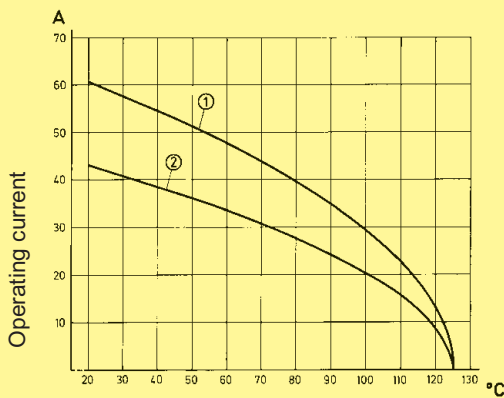

Ambient temperature

① 24 B hoods/housings with 6 modules; wire gauge: 10 mm²

② 24 B hoods/housings with 6 modules; wire gauge: 6 mm²

Number of contacts

2

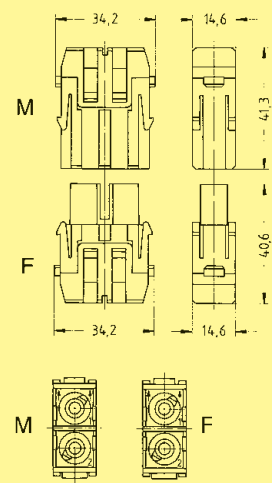

Identification	Part number		Drawing	Dimensions in mm
	Male insert (M)	Female insert (F)		
Axial screw terminal 40 A			 <p>Contact arrangement view from termination side</p>	
2.5 ... 8 mm ²	09 14 002 2601	09 14 002 2701		
6 ... 10 mm ²	09 14 002 2602	09 14 002 2702		

Han
Modular

Identification	Part number	Drawing	Dimensions in mm
Hex key SW 2 for axial setscrew			
with grip	09 99 000 0313		
Bit 1/4"	09 99 000 0369		



Features

- Axial screw terminal
- No special tools required for assembly
- Compatible to Han® C module with crimp termination

Technical characteristics

Specifications **DIN EN 60 664-1**
DIN EN 61 984

Approvals

Inserts

Number of contacts **3**
 Electrical data acc. to EN 61 984 **40 A 690 V 8 kV 3**
 Rated current **40 A**
 Rated voltage **690 V**
 Rated impulse voltage **8 kV**
 Pollution degree **3**

Rated voltage acc. to UL **600 V**
 Insulation resistance **≥ 10¹⁰ Ω**
 Material **polycarbonate**
 Limiting temperatures **-40 °C ... +125 °C**
 Flammability acc. to UL 94 **V 0**
 Mechanical working life
 - mating cycles **≥ 500**

Contacts

Material **copper alloy**

Surface
 - hard-silver plated **3 μm Ag**

Contact resistance **0.3 mΩ**

Screw terminal
 - Wire gauge ¹⁾ **2.5 ... 10 mm²**

- AWG **14 ... 8**

- Hexagonal driver **SW 2**

- Stripping length

mm ²	2.5	4	6	10
mm	5 ⁺¹	5 ⁺¹	8 ⁺¹	11 ⁺¹

- Tightening torque

mm ²	2.5	4	6	10
Nm	1.5	1.5	2	2

Current carrying capacity

The current carrying capacity of the connectors is limited by the thermal load capability of the contact element material including the connections and the insulating parts. The derating curve is therefore valid for currents which flow constantly (non-intermittent) through each contact element of the connector evenly, without exceeding the allowed maximum temperature.

Measuring and testing techniques according to DIN EN 60 512-5

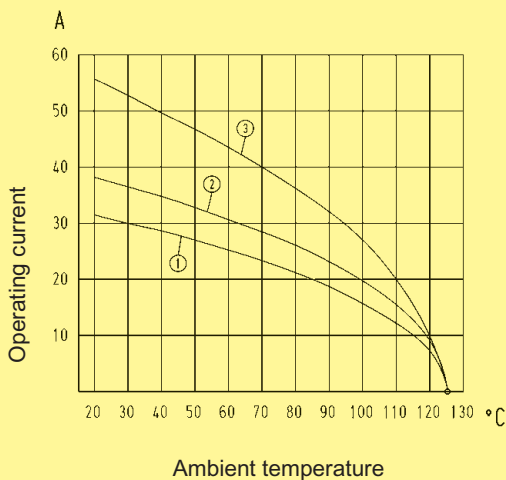

① 24 B hoods/housings with 6 modules; wire gauge: 4 mm²

② 24 B hoods/housings with 6 modules; wire gauge: 6 mm²

③ 24 B hoods/housings with 6 modules; wire gauge: 10 mm²

1) geometric wire gauge

Number of contacts

3

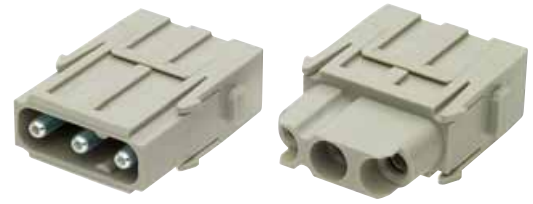

Identification	Part number		Drawing	Dimensions in mm
	Male insert (M)	Female insert (F)		
Axial screw terminal 40 A				
2.5 ... 8 mm ²	09 14 003 2601	09 14 003 2701		
6 ... 10 mm ²	09 14 003 2602	09 14 003 2702		

Han
Modular

Identification	Part number	Drawing	Dimensions in mm
Hex key SW 2 for axial setscrew			
with grip	09 99 000 0313		
Bit 1/4"	09 99 000 0369		



Features

- Suitable for Han® C crimp contacts
- Standard module for power up to 40 A
- Compatible to Han® C module with axial screw termination

Technical characteristics

Specifications DIN EN 60 664-1
 DIN EN 61 984

Approvals

Inserts

Number of contacts	3
Electrical data acc. to EN 61 984	
Cable diameter up to 5 mm	40 A 400/690 V 6 kV 3
Rated current	40 A
Rated voltage conductor - ground	400 V
Rated voltage conductor - conductor	690 V
Rated impulse voltage	6 kV
Pollution degree	3

Cable diameter up to 7.5 mm	40 A 500 V 6 kV 3
Rated current	40 A
Rated voltage	500 V
Rated impulse voltage	6 kV
Pollution degree	3

Rated voltage acc. to UL/CSA	600 V
Insulation resistance	$\geq 10^{10} \Omega$
Material	polycarbonate
Limiting temperatures	-40 °C ... +125 °C
Flammability acc. to UL 94	V 0
Mechanical working life - mating cycles	≥ 500

Contacts

Material	copper alloy
Surface	
- hard-silver plated	3 μm Ag
Contact resistance	$\leq 0.3 \text{ m}\Omega$
Crimp terminal	
- mm^2	1.5 ... 10 mm^2
- AWG	16 ... 8

Current carrying capacity

The current carrying capacity of the connectors is limited by the thermal load capability of the contact element material including the connections and the insulating parts. The derating curve is therefore valid for currents which flow constantly (non-intermittent) through each contact element of the connector evenly, without exceeding the allowed maximum temperature.

Measuring and testing techniques according to
 DIN EN 60 512-5

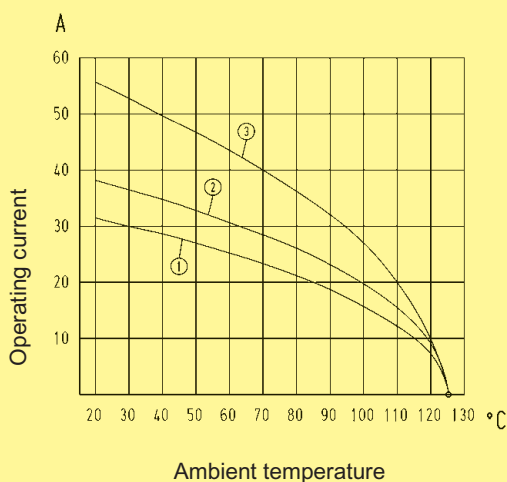

- ① 24 B hoods/housings with 6 modules; wire gauge: 4 mm^2
- ② 24 B hoods/housings with 6 modules; wire gauge: 6 mm^2
- ③ 24 B hoods/housings with 6 modules; wire gauge: 10 mm^2



Number of contacts

3

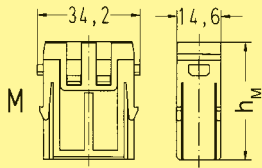
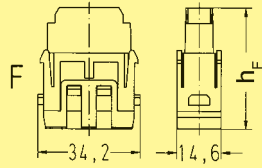
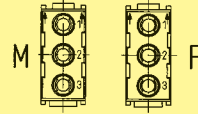

Identification	Part number		Drawing	Dimensions in mm						
	Male insert (M)	Female insert (F)								
Crimp terminal Order crimp contacts separately				<table border="1"> <tr> <td></td> <td>h_M</td> </tr> <tr> <td>09 14 003 3001</td> <td>39.1 mm</td> </tr> <tr> <td>09 14 003 3002</td> <td>43.1 mm</td> </tr> </table>		h_M	09 14 003 3001	39.1 mm	09 14 003 3002	43.1 mm
	h_M									
09 14 003 3001	39.1 mm									
09 14 003 3002	43.1 mm									
Cable diameter up to 5 mm	09 14 003 3001	09 14 003 3101		<table border="1"> <tr> <td></td> <td>h_F</td> </tr> <tr> <td>09 14 003 3101</td> <td>40.7 mm</td> </tr> <tr> <td>09 14 003 3102</td> <td>44.7 mm</td> </tr> </table>		h_F	09 14 003 3101	40.7 mm	09 14 003 3102	44.7 mm
	h_F									
09 14 003 3101	40.7 mm									
09 14 003 3102	44.7 mm									
Cable diameter up to 7.5 mm	09 14 003 3002	09 14 003 3102	 <p>Contact arrangement view from termination side</p>							

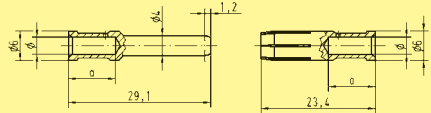
Han Modular

Identification	Wire gauge (mm ²)	Part number		Drawing	Dimensions in mm																								
		Male contact	Female contact																										
Crimp contacts Power contacts silver plated					<table border="1"> <thead> <tr> <th>Wire gauge</th> <th></th> <th>∅</th> <th>Stripping length</th> </tr> </thead> <tbody> <tr> <td>1.5 mm²</td> <td>AWG 16</td> <td>1.75</td> <td>9 mm</td> </tr> <tr> <td>2.5 mm²</td> <td>AWG 14</td> <td>2.25</td> <td>9 mm</td> </tr> <tr> <td>4 mm²</td> <td>AWG 12</td> <td>2.85</td> <td>9.6 mm</td> </tr> <tr> <td>6 mm²</td> <td>AWG 10</td> <td>3.5</td> <td>9.6 mm</td> </tr> <tr> <td>10 mm²</td> <td>AWG 8</td> <td>4.3</td> <td>15 mm</td> </tr> </tbody> </table> <p>Stripping length a = 15 mm for cables ≥ 5 mm Stripping length a = 18 mm for cables ≥ 6.4 mm</p>	Wire gauge		∅	Stripping length	1.5 mm ²	AWG 16	1.75	9 mm	2.5 mm ²	AWG 14	2.25	9 mm	4 mm ²	AWG 12	2.85	9.6 mm	6 mm ²	AWG 10	3.5	9.6 mm	10 mm ²	AWG 8	4.3	15 mm
Wire gauge		∅	Stripping length																										
1.5 mm ²	AWG 16	1.75	9 mm																										
2.5 mm ²	AWG 14	2.25	9 mm																										
4 mm ²	AWG 12	2.85	9.6 mm																										
6 mm ²	AWG 10	3.5	9.6 mm																										
10 mm ²	AWG 8	4.3	15 mm																										
	1.5 2.5 4 6 10*	09 32 000 6104 09 32 000 6105 09 32 000 6107 09 32 000 6108 09 32 000 6109	09 32 000 6204 09 32 000 6205 09 32 000 6207 09 32 000 6208 09 32 000 6209																										

* for modules 09 14 003 3002 and 09 14 003 3102 only

Stock items in bold type

Features

- Suitable for Han® C crimp contacts
- Designed for a high working voltage up to 830 V
- Finger safe male and female contacts
- High contact density

Technical characteristics

Specifications DIN EN 60 664-1
DIN EN 61 984

Approvals

Inserts

Number of contacts	4
Electrical data acc. to EN 61 984	40 A 830 V 8 kV 3
Rated current	40 A
Rated voltage	830 V
Rated impulse voltage	8 kV
Pollution degree	3
Pollution degree 2 also	40 A 1000 V 8 kV 2

Rated voltage acc. to UL	600 V
Insulation resistance	≥ 10 ¹⁰ Ω
Material	polycarbonate
Limiting temperatures	-40 °C ... +125 °C
Flammability acc. to UL 94	V 0
Mechanical working life - mating cycles	≥ 500

Contacts

Material	copper alloy
Surface	
- hard-silver plated	3 µm Ag
Contact resistance	≤ 0.3 mΩ
Crimp terminal	
- mm ²	1.5 ... 6 mm ²
- AWG	16 ... 10

Current carrying capacity

The current carrying capacity of the connectors is limited by the thermal load capability of the contact element material including the connections and the insulating parts. The derating curve is therefore valid for currents which flow constantly (non-intermittent) through each contact element of the connector evenly, without exceeding the allowed maximum temperature.

Measuring and testing techniques according to DIN EN 60 512-5

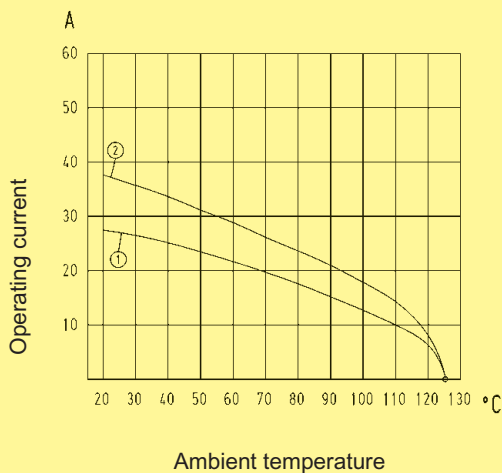

① 24 B hoods/housings with 6 modules; wire gauge: 4 mm²

② 24 B hoods/housings with 6 modules; wire gauge: 6 mm²

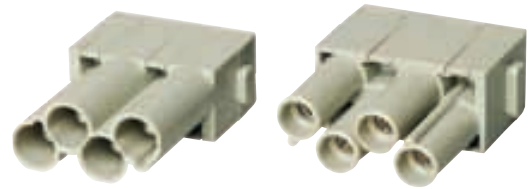

Number of contacts

4

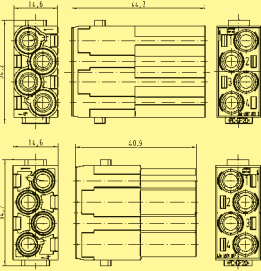

Identification	Part number		Drawing	Dimensions in mm
	Male insert (M)	Female insert (F)		
Crimp terminal Order crimp contacts separately	09 14 004 3041	09 14 004 3141	 <p>Contact arrangement view from termination side</p>	

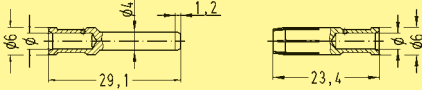
Han Modular

Identification	Wire gauge (mm ²)	Part number		Drawing	Dimensions in mm																				
		Male contact	Female contact																						
Crimp contacts Power contacts silver plated																									
	1.5 2.5 4 6	09 32 000 6104 09 32 000 6105 09 32 000 6107 09 32 000 6108	09 32 000 6204 09 32 000 6205 09 32 000 6207 09 32 000 6208	<table border="1"> <thead> <tr> <th colspan="2">Wire gauge</th> <th>∅</th> <th>Stripping length</th> </tr> </thead> <tbody> <tr> <td>1.5 mm²</td> <td>AWG 16</td> <td>1.75</td> <td>9 mm</td> </tr> <tr> <td>2.5 mm²</td> <td>AWG 14</td> <td>2.25</td> <td>9 mm</td> </tr> <tr> <td>4 mm²</td> <td>AWG 12</td> <td>2.85</td> <td>9.6 mm</td> </tr> <tr> <td>6 mm²</td> <td>AWG 10</td> <td>3.5</td> <td>9.6 mm</td> </tr> </tbody> </table>	Wire gauge		∅	Stripping length	1.5 mm ²	AWG 16	1.75	9 mm	2.5 mm ²	AWG 14	2.25	9 mm	4 mm ²	AWG 12	2.85	9.6 mm	6 mm ²	AWG 10	3.5	9.6 mm	
Wire gauge		∅	Stripping length																						
1.5 mm ²	AWG 16	1.75	9 mm																						
2.5 mm ²	AWG 14	2.25	9 mm																						
4 mm ²	AWG 12	2.85	9.6 mm																						
6 mm ²	AWG 10	3.5	9.6 mm																						

06
27

Stock items in bold type

Features

- 3 contacts (40 A) for power circuits and 4 contacts (10 A) for signal circuits
- Ideal as motor drive connector
- Male and female contacts are finger safe

Technical characteristics

Specifications DIN EN 60 664-1
DIN EN 61 984

Approvals 

Inserts

Number of contacts	3 / 4
Electrical data acc. to EN 61 984	
Power contacts	40 A 830 V 8 kV 3
Rated current	40 A
Rated voltage	830 V
Rated impulse voltage	8 kV
Pollution degree	3
Signal contacts	10 A 830 V 8 kV 3
Rated current	10 A
Rated voltage	830 V
Rated impulse voltage	8 kV
Pollution degree	3
Rated voltage acc. to UL	600 V
Insulation resistance	$\geq 10^{10} \Omega$
Material	polycarbonate
Limiting temperatures	-40 °C ... +125 °C
Flammability acc. to UL 94	V 0
Mechanical working life	
- mating cycles	≥ 500

Contacts

Material	copper alloy
Surface	
- hard-silver plated	3 μm Ag
- hard-gold plated	2 μm Au over 3 μm Ni
Contact resistance	
Power contacts	$\leq 0.3 \text{ m}\Omega$
Signal contacts	$\leq 3 \text{ m}\Omega$
Crimp terminal	
- mm^2	
Power contacts	1.5 ... 6 mm^2
Signal contacts	0.14 ... 2.5 mm^2
- AWG	
Power contacts	16 ... 10
Signal contacts	26 ... 14
Max. insulation diameter	
- Power contacts	5 mm

Current carrying capacity

The current carrying capacity of the connectors is limited by the thermal load capability of the contact element material including the connections and the insulating parts. The derating curve is therefore valid for currents which flow constantly (non-intermittent) through each contact element of the connector evenly, without exceeding the allowed maximum temperature.

Measuring and testing techniques according to DIN EN 60 512-5

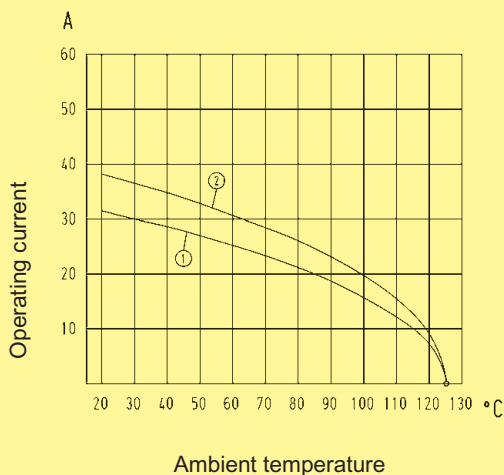

① 24 B hoods/housings with 6 modules; wire gauge: 4 mm^2

② 24 B hoods/housings with 6 modules; wire gauge: 6 mm^2

Number of contacts

3 / 4



Identification	Part number		Drawing	Dimensions in mm
	Male insert (M)	Female insert (F)		
<p>Crimp terminal</p> <p>Order crimp contacts separately</p>	09 14 007 3001	09 14 007 3101	<p style="text-align: center;">Contact arrangement view from termination side</p>	

Han Modular

Identification	Wire gauge (mm ²)	Part number		Drawing	Dimensions in mm																												
		Male contact	Female contact																														
<p>Crimp contacts</p> <p>Power contacts</p>																																	
<p>silver plated</p>	<p>1.5</p> <p>2.5</p> <p>4</p> <p>6</p>	<p>09 32 000 6104</p> <p>09 32 000 6105</p> <p>09 32 000 6107</p> <p>09 32 000 6108</p>	<p>09 32 000 6204</p> <p>09 32 000 6205</p> <p>09 32 000 6207</p> <p>09 32 000 6208</p>		<table border="1"> <thead> <tr> <th colspan="2">Wire gauge</th> <th>∅</th> <th>Stripping length</th> </tr> </thead> <tbody> <tr> <td>1.5 mm²</td> <td>AWG 16</td> <td>1.75</td> <td>9 mm</td> </tr> <tr> <td>2.5 mm²</td> <td>AWG 14</td> <td>2.25</td> <td>9 mm</td> </tr> <tr> <td>4 mm²</td> <td>AWG 12</td> <td>2.85</td> <td>9.6 mm</td> </tr> <tr> <td>6 mm²</td> <td>AWG 10</td> <td>3.5</td> <td>9.6 mm</td> </tr> </tbody> </table>	Wire gauge		∅	Stripping length	1.5 mm ²	AWG 16	1.75	9 mm	2.5 mm ²	AWG 14	2.25	9 mm	4 mm ²	AWG 12	2.85	9.6 mm	6 mm ²	AWG 10	3.5	9.6 mm								
Wire gauge		∅	Stripping length																														
1.5 mm ²	AWG 16	1.75	9 mm																														
2.5 mm ²	AWG 14	2.25	9 mm																														
4 mm ²	AWG 12	2.85	9.6 mm																														
6 mm ²	AWG 10	3.5	9.6 mm																														
<p>Signal contacts silver plated</p>	<p>0.14-0.37</p> <p>0.5</p> <p>0.75</p> <p>1</p> <p>1.5</p> <p>2.5</p>	<p>09 15 000 6104</p> <p>09 15 000 6103</p> <p>09 15 000 6105</p> <p>09 15 000 6102</p> <p>09 15 000 6101</p> <p>09 15 000 6106</p>	<p>09 15 000 6204</p> <p>09 15 000 6203</p> <p>09 15 000 6205</p> <p>09 15 000 6202</p> <p>09 15 000 6201</p> <p>09 15 000 6206</p>		<table border="1"> <thead> <tr> <th colspan="2">Wire gauge</th> <th>∅</th> <th>Stripping length</th> </tr> </thead> <tbody> <tr> <td>0.14-0.37 mm²</td> <td>AWG 26-22</td> <td>0.9</td> <td>8 mm</td> </tr> <tr> <td>0.5 mm²</td> <td>AWG 20</td> <td>1.1</td> <td>8 mm</td> </tr> <tr> <td>0.75 mm²</td> <td>AWG 18</td> <td>1.3</td> <td>8 mm</td> </tr> <tr> <td>1 mm²</td> <td>AWG 18</td> <td>1.45</td> <td>8 mm</td> </tr> <tr> <td>1.5 mm²</td> <td>AWG 16</td> <td>1.75</td> <td>8 mm</td> </tr> <tr> <td>2.5 mm²</td> <td>AWG 14</td> <td>2.25</td> <td>6 mm</td> </tr> </tbody> </table>	Wire gauge		∅	Stripping length	0.14-0.37 mm ²	AWG 26-22	0.9	8 mm	0.5 mm ²	AWG 20	1.1	8 mm	0.75 mm ²	AWG 18	1.3	8 mm	1 mm ²	AWG 18	1.45	8 mm	1.5 mm ²	AWG 16	1.75	8 mm	2.5 mm ²	AWG 14	2.25	6 mm
Wire gauge		∅	Stripping length																														
0.14-0.37 mm ²	AWG 26-22	0.9	8 mm																														
0.5 mm ²	AWG 20	1.1	8 mm																														
0.75 mm ²	AWG 18	1.3	8 mm																														
1 mm ²	AWG 18	1.45	8 mm																														
1.5 mm ²	AWG 16	1.75	8 mm																														
2.5 mm ²	AWG 14	2.25	6 mm																														
<p>gold plated</p>	<p>0.14-0.37</p> <p>0.5</p> <p>0.75</p> <p>1</p> <p>1.5</p> <p>2.5</p>	<p>09 15 000 6124</p> <p>09 15 000 6123</p> <p>09 15 000 6125</p> <p>09 15 000 6122</p> <p>09 15 000 6121</p> <p>09 15 000 6126</p>	<p>09 15 000 6224</p> <p>09 15 000 6223</p> <p>09 15 000 6225</p> <p>09 15 000 6222</p> <p>09 15 000 6221</p> <p>09 15 000 6226</p>																														

Stock items in bold type

Features

- Suitable for Han E[®] crimp contacts
- Standard module for power up to 40 A

Technical characteristics

Specifications DIN EN 60 664-1
 DIN EN 61 984

Approvals

Inserts

Number of contacts 6
 Electrical data
 acc. to EN 61 984 **16 A 500 V 6 kV 3**
 Rated current 16 A
 Rated voltage 500 V
 Rated impulse voltage 6 kV
 Pollution degree 3
 Pollution degree 2 also 16 A 400/690 V 6 kV 2

Rated voltage
 acc. to UL/CSA 600 V
 Insulation resistance $\geq 10^{10} \Omega$
 Material polycarbonate
 Limiting temperatures -40 °C ... +125 °C
 Flammability acc. to UL 94 V 0
 Mechanical working life
 - mating cycles ≥ 500

Contacts

Material copper alloy
 Surface
 - hard-silver plated 3 μm Ag
 - hard-gold plated 2 μm Au over 3 μm Ni
 Contact resistance $\leq 1 \text{ m}\Omega$
 Crimp terminal
 - mm² 0.14 ... 4 mm²
 - AWG 26 ... 12

Current carrying capacity

The current carrying capacity of the connectors is limited by the thermal load capability of the contact element material including the connections and the insulating parts. The derating curve is therefore valid for currents which flow constantly (non-intermittent) through each contact element of the connector evenly, without exceeding the allowed maximum temperature.

Measuring and testing techniques according to DIN EN 60 512-5

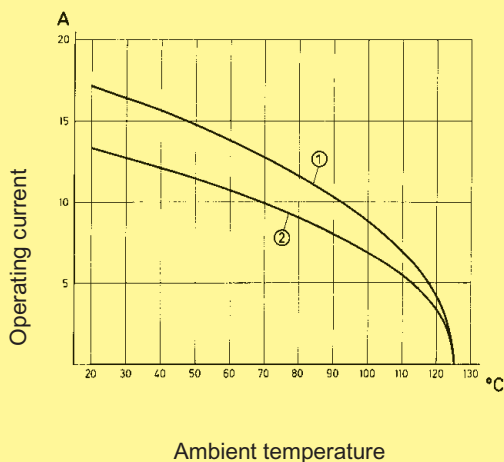

① 24 B hoods/housings with 6 modules; wire gauge: 2.5 mm²

② 24 B hoods/housings with 6 modules; wire gauge: 1.5 mm²





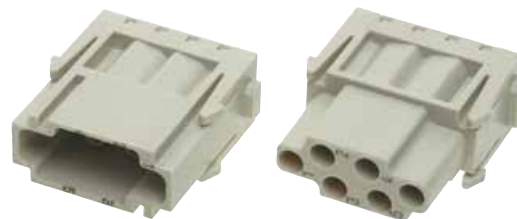

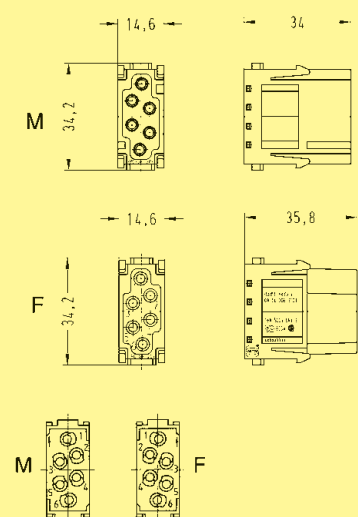
Number of contacts

6

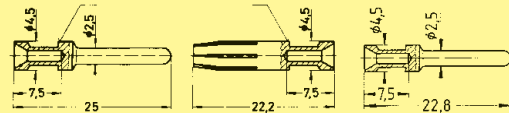

Identification	Part number		Drawing	Dimensions in mm
	Male insert (M)	Female insert (F)		
<p>Crimp terminal</p> <p>Order crimp contacts separately</p>	09 14 006 3001	09 14 006 3101	 <p>Contact arrangement view from termination side</p>	

Han Modular

Identification	Wire gauge (mm ²)	Part number		Drawing	Dimensions in mm																											
		Male contact	Female contact																													
<p>Crimp contacts</p> <p>Power contacts</p>				<p>Operating contact Identification</p> <p>Relay contact</p> 																												
<p>silver plated</p>  	<p>0,14-0,37</p> <p>0,5</p> <p>0,75</p> <p>1</p> <p>1,5</p> <p>2,5</p> <p>3</p> <p>4</p>	<p>09 33 000 6127</p> <p>09 33 000 6121</p> <p>09 33 000 6114</p> <p>09 33 000 6105</p> <p>09 33 000 6104</p> <p>09 33 000 6102</p> <p>09 33 000 6106</p> <p>09 33 000 6107</p>	<p>09 33 000 6227</p> <p>09 33 000 6220</p> <p>09 33 000 6214</p> <p>09 33 000 6205</p> <p>09 33 000 6204</p> <p>09 33 000 6202</p> <p>09 33 000 6206</p> <p>09 33 000 6207</p>	<table border="1"> <thead> <tr> <th>Identification</th> <th>Wire gauge</th> <th>Stripping length</th> </tr> </thead> <tbody> <tr> <td>no groove</td> <td>0.14-0.37 mm²</td> <td>AWG 26-22</td> </tr> <tr> <td>no groove</td> <td>0.5 mm²</td> <td>AWG 20</td> </tr> <tr> <td>1 groove*</td> <td>0.75 mm²</td> <td>AWG 18</td> </tr> <tr> <td>1 groove</td> <td>1 mm²</td> <td>AWG 18</td> </tr> <tr> <td>2 grooves</td> <td>1.5 mm²</td> <td>AWG 16</td> </tr> <tr> <td>3 grooves</td> <td>2.5 mm²</td> <td>AWG 14</td> </tr> <tr> <td>wide groove</td> <td>3 mm²</td> <td>AWG 12</td> </tr> <tr> <td>no groove</td> <td>4 mm²</td> <td>AWG 12</td> </tr> </tbody> </table> <p>* on the back crimp collar</p>	Identification	Wire gauge	Stripping length	no groove	0.14-0.37 mm ²	AWG 26-22	no groove	0.5 mm ²	AWG 20	1 groove*	0.75 mm ²	AWG 18	1 groove	1 mm ²	AWG 18	2 grooves	1.5 mm ²	AWG 16	3 grooves	2.5 mm ²	AWG 14	wide groove	3 mm ²	AWG 12	no groove	4 mm ²	AWG 12	
Identification	Wire gauge	Stripping length																														
no groove	0.14-0.37 mm ²	AWG 26-22																														
no groove	0.5 mm ²	AWG 20																														
1 groove*	0.75 mm ²	AWG 18																														
1 groove	1 mm ²	AWG 18																														
2 grooves	1.5 mm ²	AWG 16																														
3 grooves	2.5 mm ²	AWG 14																														
wide groove	3 mm ²	AWG 12																														
no groove	4 mm ²	AWG 12																														
<p>gold plated</p>  	<p>0,14-0,37</p> <p>0,5</p> <p>0,75</p> <p>1</p> <p>1,5</p> <p>2,5</p> <p>4</p>	<p>09 33 000 6117</p> <p>09 33 000 6122</p> <p>09 33 000 6115</p> <p>09 33 000 6118</p> <p>09 33 000 6116</p> <p>09 33 000 6123</p> <p>09 33 000 6119</p>	<p>09 33 000 6217</p> <p>09 33 000 6222</p> <p>09 33 000 6215</p> <p>09 33 000 6218</p> <p>09 33 000 6216</p> <p>09 33 000 6223</p> <p>09 33 000 6221</p>																													
<p>Relay contact silver plated</p> 	<p>0,75-1</p> <p>1,5</p> <p>2,5</p>	<p>09 33 000 6109</p> <p>09 33 000 6110</p> <p>09 33 000 6111</p>																														

Crimp contacts 0.14 ... 0.37 mm² only used with BUCHANAN crimping tool 09 99 000 0001

Stock items in bold type

Features

- Suitable for Han E[®] crimp contacts
- High contact density
- Compatible to the Han[®] EE module with Quick Lock termination

Technical characteristics

Specifications DIN EN 60 664-1
DIN EN 61 984

Approvals

Inserts

Number of contacts	8
Electrical data acc. to EN 61 984	16 A 400 V 6 kV 3
Rated current	16 A
Rated voltage	400 V
Rated impulse voltage	6 kV
Pollution degree	3
Pollution degree 2 also	16 A 400/690 V 6 kV 2

Rated voltage acc. to UL	600 V
Insulation resistance	$\geq 10^{10} \Omega$
Material	polycarbonate
Limiting temperatures	-40 °C ... +125 °C
Flammability acc. to UL 94	V 0
Mechanical working life - mating cycles	≥ 500

Contacts

Material	copper alloy
Surface	
- hard-silver plated	3 μm Ag
- hard-gold plated	2 μm Au over 3 μm Ni
Contact resistance	$\leq 1 \text{ m}\Omega$
Crimp terminal	
- mm^2	0.14 ... 4 mm^2
- AWG	26 ... 12

Current carrying capacity

The current carrying capacity of the connectors is limited by the thermal load capability of the contact element material including the connections and the insulating parts. The derating curve is therefore valid for currents which flow constantly (non-intermittent) through each contact element of the connector evenly, without exceeding the allowed maximum temperature.

Measuring and testing techniques according to
DIN EN 60 512-5

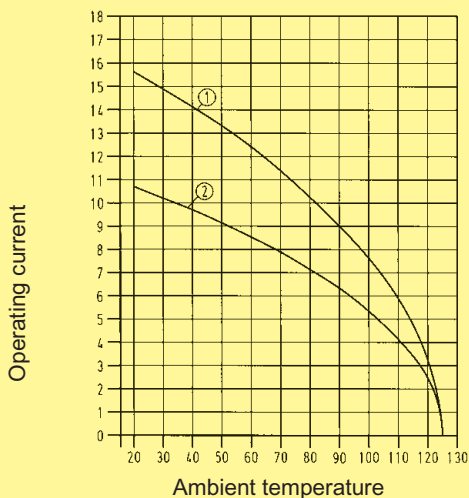

① 24 B hoods/housings with 6 modules; wire gauge: 2.5 mm^2

② 24 B hoods/housings with 6 modules; wire gauge: 1.5 mm^2





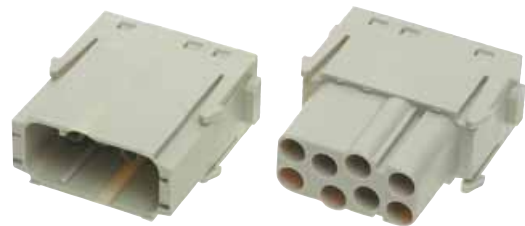

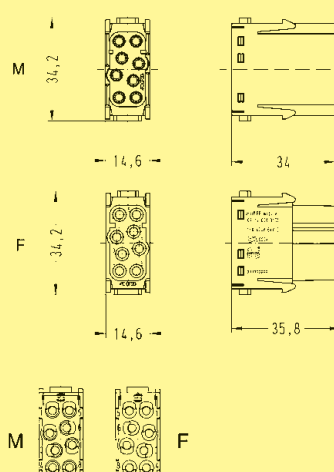
Number of contacts

8

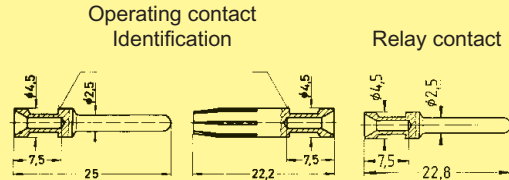

Identification	Part number		Drawing	Dimensions in mm
	Male insert (M)	Female insert (F)		
Crimp terminal Order crimp contacts separately	09 14 008 3001	09 14 008 3101	 <p style="text-align: center;">Contact arrangement view from termination side</p>	

Han Modular

Identification	Wire gauge (mm²)	Part number		Drawing	Dimensions in mm																																				
		Male contact	Female contact																																						
Crimp contacts Power contacts																																									
silver plated  	0.14-0.37 0.5 0.75 1 1.5 2.5 3 4	09 33 000 6127 09 33 000 6121 09 33 000 6114 09 33 000 6105 09 33 000 6104 09 33 000 6102 09 33 000 6106 09 33 000 6107	09 33 000 6227 09 33 000 6220 09 33 000 6214 09 33 000 6205 09 33 000 6204 09 33 000 6202 09 33 000 6206 09 33 000 6207	<table border="1"> <thead> <tr> <th>Identification</th> <th colspan="2">Wire gauge</th> <th>Stripping length</th> </tr> </thead> <tbody> <tr> <td>no groove</td> <td>0.14-0.37 mm²</td> <td>AWG 26-22</td> <td>7.5 mm</td> </tr> <tr> <td>no groove</td> <td>0.5 mm²</td> <td>AWG 20</td> <td>7.5 mm</td> </tr> <tr> <td>1 groove*</td> <td>0.75 mm²</td> <td>AWG 18</td> <td>7.5 mm</td> </tr> <tr> <td>1 groove</td> <td>1 mm²</td> <td>AWG 18</td> <td>7.5 mm</td> </tr> <tr> <td>2 grooves</td> <td>1.5 mm²</td> <td>AWG 16</td> <td>7.5 mm</td> </tr> <tr> <td>3 grooves</td> <td>2.5 mm²</td> <td>AWG 14</td> <td>7.5 mm</td> </tr> <tr> <td>wide groove</td> <td>3 mm²</td> <td>AWG 12</td> <td>7.5 mm</td> </tr> <tr> <td>no groove</td> <td>4 mm²</td> <td>AWG 12</td> <td>7.5 mm</td> </tr> </tbody> </table> <p style="text-align: center;">* on the back crimp collar</p>	Identification	Wire gauge		Stripping length	no groove	0.14-0.37 mm²	AWG 26-22	7.5 mm	no groove	0.5 mm²	AWG 20	7.5 mm	1 groove*	0.75 mm²	AWG 18	7.5 mm	1 groove	1 mm²	AWG 18	7.5 mm	2 grooves	1.5 mm²	AWG 16	7.5 mm	3 grooves	2.5 mm²	AWG 14	7.5 mm	wide groove	3 mm²	AWG 12	7.5 mm	no groove	4 mm²	AWG 12	7.5 mm	
Identification	Wire gauge		Stripping length																																						
no groove	0.14-0.37 mm²	AWG 26-22	7.5 mm																																						
no groove	0.5 mm²	AWG 20	7.5 mm																																						
1 groove*	0.75 mm²	AWG 18	7.5 mm																																						
1 groove	1 mm²	AWG 18	7.5 mm																																						
2 grooves	1.5 mm²	AWG 16	7.5 mm																																						
3 grooves	2.5 mm²	AWG 14	7.5 mm																																						
wide groove	3 mm²	AWG 12	7.5 mm																																						
no groove	4 mm²	AWG 12	7.5 mm																																						
gold plated  	0.14-0.37 0.5 0.75 1 1.5 2.5 4	09 33 000 6117 09 33 000 6122 09 33 000 6115 09 33 000 6118 09 33 000 6116 09 33 000 6123 09 33 000 6119	09 33 000 6217 09 33 000 6222 09 33 000 6215 09 33 000 6218 09 33 000 6216 09 33 000 6223 09 33 000 6221																																						
Relay contact silver plated 	0.75-1 1.5 2.5	09 33 000 6109 09 33 000 6110 09 33 000 6111																																							

Crimp contacts 0.14 ... 0.37 mm² only used with BUCHANAN crimping tool 09 99 000 0001

Stock items in bold type

Features

- Innovative Han-Quick Lock® termination technology
- Field assembly without special tools
- Compatible to standard Han® EE module with crimp termination
- Reduced wiring times

Technical characteristics

Specifications	DIN EN 60 664-1 DIN EN 61 984
----------------	----------------------------------

Inserts

Number of contacts	8
Electrical data acc. to EN 61 984	16 A 400 V 6 kV 3
Rated current	16 A
Rated voltage	400 V
Rated impulse voltage	6 kV
Pollution degree	3
Pollution degree 2 also	16 A 400/690 V 6 kV 2
Insulation resistance	$\geq 10^{10} \Omega$
Material	polycarbonate
Limiting temperatures	-40 °C ... +125 °C
Flammability acc. to UL 94	V 0
Mechanical working life - mating cycles	≥ 500

Contacts

Material	copper alloy
Surface	
- hard-silver plated	3 μm Ag
Contact resistance	$\leq 1 \text{ m}\Omega$
Quick Lock termination	
- mm^2	0.5 ... 2.5 mm^2
- AWG	20 ... 14

Number of contacts

8

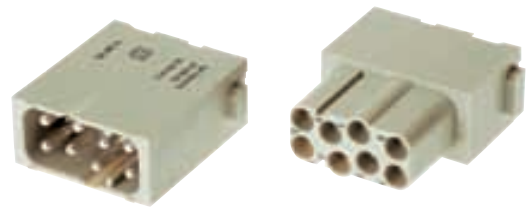

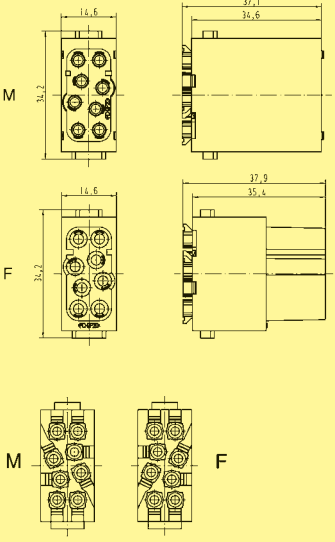
Identification	Part number		Drawing	Dimensions in mm
	Male insert (M)	Female insert (F)		
Quick Lock termination 	09 14 008 2633	09 14 008 2733		
			Contact arrangement view from termination side	

Han
Modular

Features

- Suitable for Han E[®] crimp contacts
- designed for a high working voltage up to 830 V
- finger safe male and female contacts

Technical characteristics

Specifications DIN EN 60 664-1
DIN EN 61 984

Approvals

Inserts

Number of contacts 6
Electrical data
acc. to EN 61 984 **16 A 830 V 8 kV 3**
Rated current 16 A
Rated voltage 830 V
Rated impulse voltage 8 kV
Pollution degree 3
Pollution degree 2 also 16 A 1250 V 10 kV 2

Rated voltage
acc. to UL 600 V
Insulation resistance $\geq 10^{10} \Omega$
Material polycarbonate
Limiting temperatures $-40\text{ }^\circ\text{C} \dots +125\text{ }^\circ\text{C}$
Flammability acc. to UL 94 V 0
Mechanical working life
- mating cycles ≥ 500

Contacts

Material copper alloy
Surface
- hard-silver plated 3 μm Ag
- hard-gold plated 2 μm Au over 3 μm Ni
Contact resistance $\leq 1\text{ m}\Omega$
Crimp terminal
- mm² 0.14 ... 4 mm²
- AWG 26 ... 12

Current carrying capacity

The current carrying capacity of the connectors is limited by the thermal load capability of the contact element material including the connections and the insulating parts. The derating curve is therefore valid for currents which flow constantly (non-intermittent) through each contact element of the connector evenly, without exceeding the allowed maximum temperature.

Measuring and testing techniques according to DIN EN 60 512-5

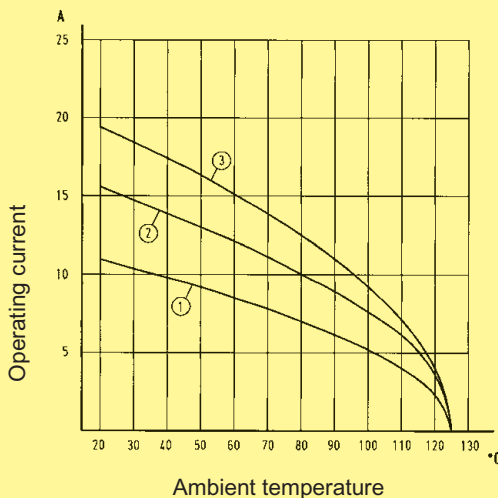

① 24 B hoods/housings with 6 modules; wire gauge: 1.5 mm²

② 24 B hoods/housings with 6 modules; wire gauge: 2.5 mm²

③ 24 B hoods/housings with 6 modules; wire gauge: 4 mm²





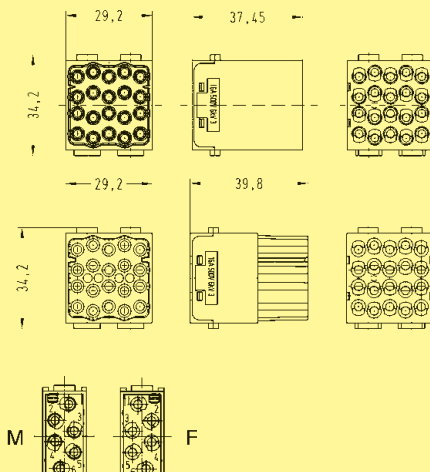

Number of contacts

6

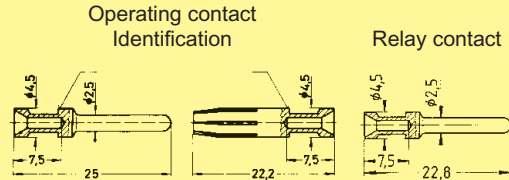

Identification	Part number		Drawing	Dimensions in mm
	Male insert (M)	Female insert (F)		
<p>Crimp terminal</p> <p>Order crimp contacts separately</p>	09 14 006 3041	09 14 006 3141	 <p>Contact arrangement view from termination side</p>	

Han Modular

Identification	Wire gauge (mm ²)	Part number		Drawing	Dimensions in mm
		Male contact	Female contact		
<p>Crimp contacts</p> <p>Power contacts</p>					
<p>silver plated</p>  	<p>0.14-0.37</p> <p>0.5</p> <p>0.75</p> <p>1</p> <p>1.5</p> <p>2.5</p> <p>3</p> <p>4</p>	<p>09 33 000 6127</p> <p>09 33 000 6121</p> <p>09 33 000 6114</p> <p>09 33 000 6105</p> <p>09 33 000 6104</p> <p>09 33 000 6102</p> <p>09 33 000 6106</p> <p>09 33 000 6107</p>	<p>09 33 000 6227</p> <p>09 33 000 6220</p> <p>09 33 000 6214</p> <p>09 33 000 6205</p> <p>09 33 000 6204</p> <p>09 33 000 6202</p> <p>09 33 000 6206</p> <p>09 33 000 6207</p>		
<p>gold plated</p>  	<p>0.14-0.37</p> <p>0.5</p> <p>0.75</p> <p>1</p> <p>1.5</p> <p>2.5</p> <p>4</p>	<p>09 33 000 6117</p> <p>09 33 000 6122</p> <p>09 33 000 6115</p> <p>09 33 000 6118</p> <p>09 33 000 6116</p> <p>09 33 000 6123</p> <p>09 33 000 6119</p>	<p>09 33 000 6217</p> <p>09 33 000 6222</p> <p>09 33 000 6215</p> <p>09 33 000 6218</p> <p>09 33 000 6216</p> <p>09 33 000 6223</p> <p>09 33 000 6221</p>		
<p>Relay contact silver plated</p> 	<p>0.75-1</p> <p>1.5</p> <p>2.5</p>	<p>09 33 000 6109</p> <p>09 33 000 6110</p> <p>09 33 000 6111</p>			

Identification	Wire gauge	Stripping length
no groove	0.14-0.37 mm ²	AWG 26-22
no groove	0.5 mm ²	AWG 20
1 groove*	0.75 mm ²	AWG 18
1 groove	1 mm ²	AWG 18
2 grooves	1.5 mm ²	AWG 16
3 grooves	2.5 mm ²	AWG 14
wide groove	3 mm ²	AWG 12
no groove	4 mm ²	AWG 12

* on the back crimp collar

Crimp contacts 0.14 ... 0.37 mm² only used with BUCHANAN crimping tool 09 99 000 0001

Stock items in bold type

Features

- Suitable for Han E® crimp contacts
- High contact density
- Up to 16 A per contact
- Also suitable as a reliable signal connector

Technical characteristics

Specifications DIN EN 60 664-1
 DIN EN 61 984

Approvals

Inserts

Number of contacts 20
 Electrical data
 acc. to EN 61 984 **16 A 500 V 6 kV 3**
 Rated current 16 A
 Rated voltage 500 V
 Rated impulse voltage 6 kV
 Pollution degree 3
 Pollution degree 2 also 16 A 830 V 8 kV 2

Rated voltage
 acc. to UL 600 V
 Insulation resistance $\geq 10^{10} \Omega$
 Material polycarbonate
 Limiting temperatures -40 °C ... +125 °C
 Flammability acc. to UL 94 V 0
 Mechanical working life
 - mating cycles ≥ 500

Contacts

Material copper alloy
 Surface
 - hard-silver plated 3 μm Ag
 - hard-gold plated 2 μm Au over 3 μm Ni
 Contact resistance $\leq 1 \text{ m}\Omega$
 Crimp terminal
 - mm^2 0.14 ... 4 mm^2
 - AWG 26 ... 12

Current carrying capacity

The current carrying capacity of the connectors is limited by the thermal load capability of the contact element material including the connections and the insulating parts. The derating curve is therefore valid for currents which flow constantly (non-intermittent) through each contact element of the connector evenly, without exceeding the allowed maximum temperature.

Measuring and testing techniques according to DIN EN 60 512-5

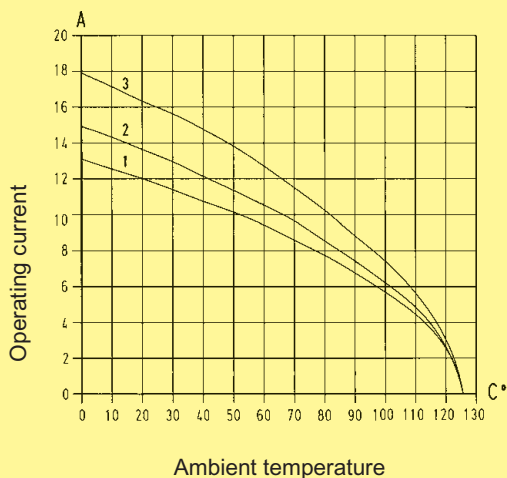

- ① 24 B hoods/housings with 3 modules; wire gauge: 1.5 mm^2
- ② 24 B hoods/housings with 3 modules; wire gauge: 2.5 mm^2
- ③ 24 B hoods/housings with 3 modules; wire gauge: 4 mm^2



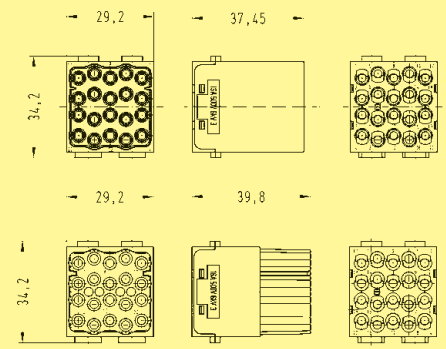

Number of contacts

20

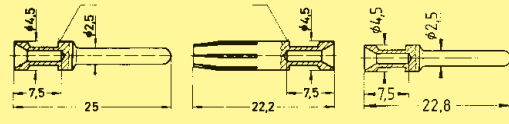

Identification	Part number		Drawing	Dimensions in mm
	Male insert (M)	Female insert (F)		
<p>Crimp terminal</p> <p>Order crimp contacts separately</p>	09 14 020 3001	09 14 020 3101	 <p>Contact arrangement view from termination side</p>	

Han Modular

Identification	Wire gauge (mm ²)	Part number		Drawing	Dimensions in mm
		Male contact	Female contact		
<p>Crimp contacts</p> <p>Power contacts</p>				<p>Operating contact Identification</p> <p>Relay contact</p> 	
<p>silver plated</p> 	0.14-0.37	09 33 000 6127	09 33 000 6227		
	0.5	09 33 000 6121	09 33 000 6220		
	0.75	09 33 000 6114	09 33 000 6214		
	1	09 33 000 6105	09 33 000 6205		
	1.5	09 33 000 6104	09 33 000 6204		
	2.5	09 33 000 6102	09 33 000 6202		
	3	09 33 000 6106	09 33 000 6206		
	4	09 33 000 6107	09 33 000 6207		
<p>gold plated</p> 	0.14-0.37	09 33 000 6117	09 33 000 6217		
	0.5	09 33 000 6122	09 33 000 6222		
	0.75	09 33 000 6115	09 33 000 6215		
	1	09 33 000 6118	09 33 000 6218		
	1.5	09 33 000 6116	09 33 000 6216		
	2.5	09 33 000 6123	09 33 000 6223		
	4	09 33 000 6119	09 33 000 6221		
<p>Relay contact</p> <p>silver plated</p> 	0.75-1	09 33 000 6109			
	1.5	09 33 000 6110			
	2.5	09 33 000 6111			

Identification	Wire gauge		Stripping length
no groove	0.14-0.37 mm ²	AWG 26-22	7.5 mm
no groove	0.5 mm ²	AWG 20	7.5 mm
1 groove*	0.75 mm ²	AWG 18	7.5 mm
1 groove	1 mm ²	AWG 18	7.5 mm
2 grooves	1.5 mm ²	AWG 16	7.5 mm
3 grooves	2.5 mm ²	AWG 14	7.5 mm
wide groove	3 mm ²	AWG 12	7.5 mm
no groove	4 mm ²	AWG 12	7.5 mm

* on the back crimp collar

Crimp contacts 0.14 ... 0.37 mm² only used with BUCHANAN crimping tool 09 99 000 0001

Stock items in bold type

Features

- Cage-clamp terminal
- No special tools required

Technical characteristics

Specifications DIN EN 60 664-1
DIN EN 61 984

Approvals 

Inserts

Number of contacts	5
Electrical data acc. to EN 61 984	16 A 400 V 6 kV 3
Rated current	16 A
Rated voltage	400 V
Rated impulse voltage	6 kV
Pollution degree	3
Pollution degree 2 also	16 A 500 V 6 kV 2

Rated voltage acc. to UL	600 V
Insulation resistance	$\geq 10^{10} \Omega$
Material	polycarbonate
Limiting temperatures	-40 °C ... +125 °C
Flammability acc. to UL 94	V 0
Mechanical working life - mating cycles	≥ 500

Contacts

Material	copper alloy
Surface	
- hard-silver plated	3 μm Ag
Contact resistance	$\leq 3 \text{ m}\Omega$
Cage clamp terminal	
- mm ²	0.14 ... 2.5 mm ²
- AWG	26 ... 14

Current carrying capacity

The current carrying capacity of the connectors is limited by the thermal load capability of the contact element material including the connections and the insulating parts. The derating curve is therefore valid for currents which flow constantly (non-intermittent) through each contact element of the connector evenly, without exceeding the allowed maximum temperature.

Measuring and testing techniques according to
DIN EN 60 512-5

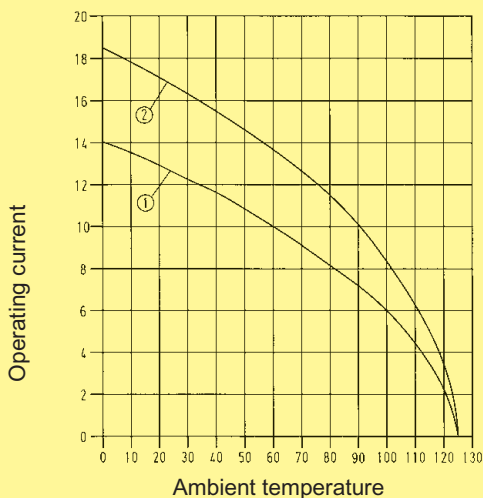

① 24 B hoods/housings with 6 modules; wire gauge: 2.5 mm²

② 24 B hoods/housings with 6 modules; wire gauge: 1.5 mm²

Number of contacts

5

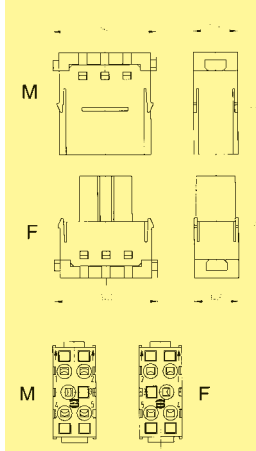

Identification	Part number		Drawing	Dimensions in mm
	Male insert (M)	Female insert (F)		
Cage-clamp terminal	09 14 005 2616	09 14 005 2716	 <p> M F M F </p> <p>Contact arrangement view from termination side</p>	

Han
Modular

Features

- Suitable for Han E® crimp contacts
- 2 contacts up to 5000 V
- Insulator out of a voltage resistant teflon material
- Combination of all other modules (pneumatic, signal etc.)

Technical characteristics

Specifications	DIN EN 61 984 DIN VDE 0115 DIN EN 60 664-1
----------------	--

Inserts

Number of contacts	2
Electrical data acc. to EN 61 984	16 A 2900/5000 V 15 kV 3
Rated current	16 A
Rated voltage conductor - ground	2900 V
Rated voltage conductor - conductor	5000 V
Rated impulse voltage	15 kV
Pollution degree	3
Pollution degree 2 also	16 A 5800/10000 V 25 kV 2
Insulation resistance	$\geq 10^{10} \Omega$
Material	polycarbonate/Teflon (PTFE)
Limiting temperatures	-40 °C ... +125 °C
Flammability acc. to UL 94	V 0
Mechanical working life - mating cycles	≥ 500

Contacts

Material	copper alloy
Surface	
- hard-silver plated	3 μm Ag
- hard-gold plated	2 μm Au over 3 μm Ni
Contact resistance	$\leq 1 \text{ m}\Omega$
Crimp terminal	
- mm ²	0.5 ... 4 mm ²
- AWG	20 ... 12

Assembly instructions

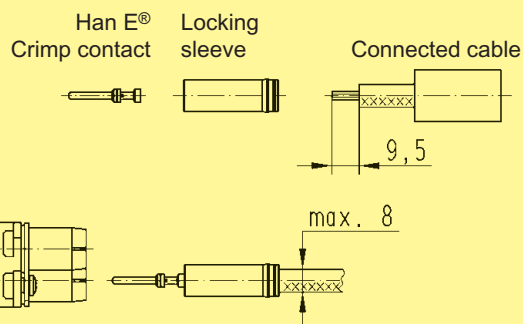

Crimp with BUCHANAN crimping tool
09 99 000 0001
Snap crimped cable in the insert

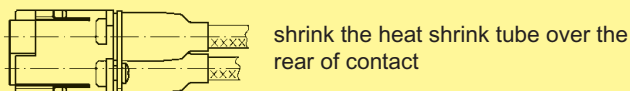

Current carrying capacity

The current carrying capacity of the connectors is limited by the thermal load capability of the contact element material including the connections and the insulating parts. The derating curve is therefore valid for currents which flow constantly (non-intermittent) through each contact element of the connector evenly, without exceeding the allowed maximum temperature.

Measuring and testing techniques according to
DIN EN 60 512-5

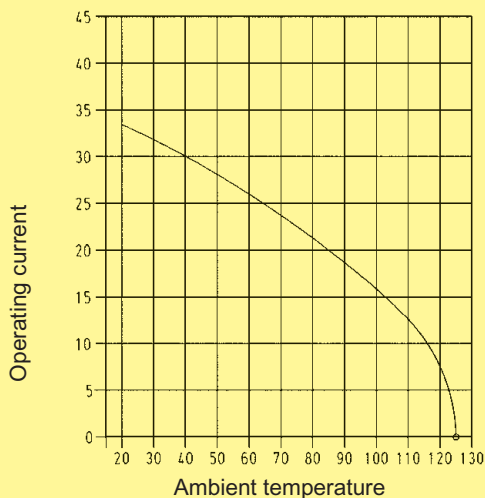

① Housing Han® 16 B with 1 Han® HV module, wire gauge:
2.5 mm²

Number of contacts

2

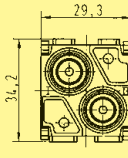
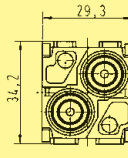
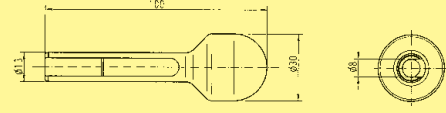

Identification	Part number		Drawing	Dimensions in mm
	Male insert (M)	Female insert (F)		
<p>Crimp terminal</p> <p>Order crimp contacts separately</p> <p>Range of delivery:</p> <ul style="list-style-type: none"> - 1 module - 2 locking sleeves - 2 heat shrink tubes <p>Removal tool for locking sleeve</p>	09 14 002 3021	09 14 002 3121	<p>M</p>  <p>F</p>  	
	09 99 000 0327	09 99 000 0327		

Han Modular

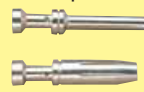
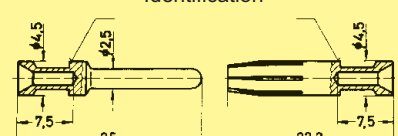
Identification	Wire gauge (mm²)	Part number		Drawing	Dimensions in mm																																
		Male contact	Female contact																																		
<p>Crimp contacts</p> <p>silver plated</p> 	0.5 0.75 1 1.5 2.5 3 4	09 33 000 6121 09 33 000 6114 09 33 000 6105 09 33 000 6104 09 33 000 6102 09 33 000 6106 09 33 000 6107	09 33 000 6220 09 33 000 6214 09 33 000 6205 09 33 000 6204 09 33 000 6202 09 33 000 6206 09 33 000 6207	<p>Operating contact Identification</p> 																																	
				<table border="1"> <thead> <tr> <th>Identification</th> <th colspan="2">Wire gauge</th> <th>Stripping length</th> </tr> </thead> <tbody> <tr> <td>no groove</td> <td>0.5 mm²</td> <td>AWG 20</td> <td>9.5 mm</td> </tr> <tr> <td>1 groove*</td> <td>0.75 mm²</td> <td>AWG 18</td> <td>9.5 mm</td> </tr> <tr> <td>1 groove</td> <td>1 mm²</td> <td>AWG 18</td> <td>9.5 mm</td> </tr> <tr> <td>2 grooves</td> <td>1.5 mm²</td> <td>AWG 16</td> <td>9.5 mm</td> </tr> <tr> <td>3 grooves</td> <td>2.5 mm²</td> <td>AWG 14</td> <td>9.5 mm</td> </tr> <tr> <td>wide groove</td> <td>3 mm²</td> <td>AWG 12</td> <td>9.5 mm</td> </tr> <tr> <td>no groove</td> <td>4 mm²</td> <td>AWG 12</td> <td>9.5 mm</td> </tr> </tbody> </table> <p>* on the back crimp collar</p>	Identification	Wire gauge		Stripping length	no groove	0.5 mm²	AWG 20	9.5 mm	1 groove*	0.75 mm²	AWG 18	9.5 mm	1 groove	1 mm²	AWG 18	9.5 mm	2 grooves	1.5 mm²	AWG 16	9.5 mm	3 grooves	2.5 mm²	AWG 14	9.5 mm	wide groove	3 mm²	AWG 12	9.5 mm	no groove	4 mm²	AWG 12	9.5 mm	
Identification	Wire gauge		Stripping length																																		
no groove	0.5 mm²	AWG 20	9.5 mm																																		
1 groove*	0.75 mm²	AWG 18	9.5 mm																																		
1 groove	1 mm²	AWG 18	9.5 mm																																		
2 grooves	1.5 mm²	AWG 16	9.5 mm																																		
3 grooves	2.5 mm²	AWG 14	9.5 mm																																		
wide groove	3 mm²	AWG 12	9.5 mm																																		
no groove	4 mm²	AWG 12	9.5 mm																																		

Features

- Suitable for Han D[®] crimp contacts
- Standard module for power up to 10 A

Technical characteristics

Specifications DIN EN 60 664-1
 DIN EN 61 984

Approvals

Inserts

Number of contacts	12
Electrical data acc. to EN 61 984	10 A 250 V 4 kV 3
Rated current	10 A
Rated voltage	250 V
Rated impulse voltage	4 kV
Pollution degree	3
Rated voltage acc. to UL/CSA	600 V
Insulation resistance	≥ 10 ¹⁰ Ω
Material	polycarbonate
Limiting temperatures	-40 °C ... +125 °C
Flammability acc. to UL 94	V 0
Mechanical working life - mating cycles	≥ 500

Contacts

Material	copper alloy
Surface	
- hard-silver plated	3 μm Ag
- hard-gold plated	2 μm Au over 3 μm Ni
Contact resistance	≤ 3 mΩ
Crimp terminal	
- mm ²	0.14 ... 2.5 mm ²
- AWG	26 ... 14

Han
Modular

Current carrying capacity

The current carrying capacity of the connectors is limited by the thermal load capability of the contact element material including the connections and the insulating parts. The derating curve is therefore valid for currents which flow constantly (non-intermittent) through each contact element of the connector evenly, without exceeding the allowed maximum temperature.

Measuring and testing techniques according to
 DIN EN 60 512-5

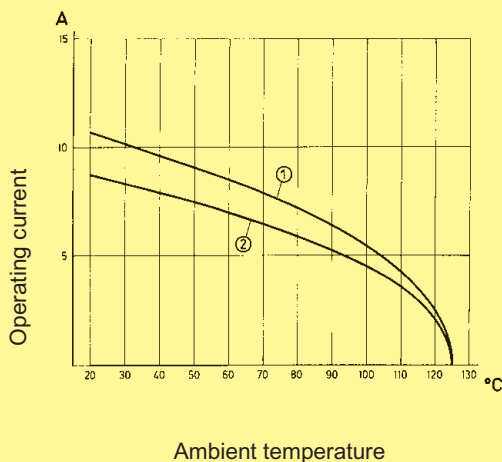

① 24 B hoods/housings with 6 modules; wire gauge: 1.5 mm²

② 24 B hoods/housings with 6 modules; wire gauge: 1.0 mm²





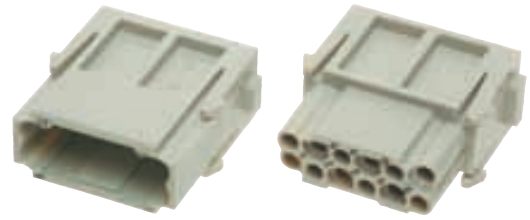

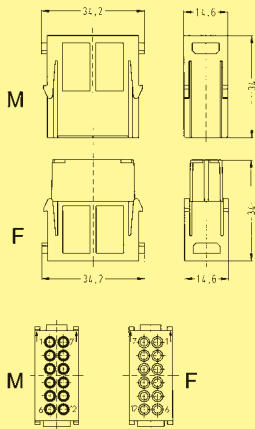

Number of contacts

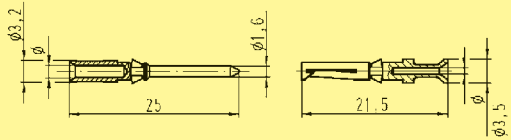
12

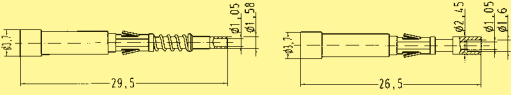

Identification	Part number		Drawing	Dimensions in mm
	Male insert (M)	Female insert (F)		
Crimp terminal Order crimp contacts separately	09 14 012 3001	09 14 012 3101	 <p>M</p> <p>F</p> <p>M</p> <p>F</p> <p>Contact arrangement view from termination side</p>	

Han Modular

Identification	Wire gauge (mm ²)	Part number		Drawing	Dimensions in mm																												
		Male contact	Female contact																														
Crimp contacts																																	
Power contacts																																	
silver plated	0.14-0.37	09 15 000 6104	09 15 000 6204	 <table border="1"> <thead> <tr> <th colspan="2">Wire gauge</th> <th>∅</th> <th>Stripping length</th> </tr> </thead> <tbody> <tr> <td>0.14-0.37 mm²</td> <td>AWG 26-22</td> <td>0.9</td> <td>8 mm</td> </tr> <tr> <td>0.5 mm²</td> <td>AWG 20</td> <td>1.1</td> <td>8 mm</td> </tr> <tr> <td>0.75 mm²</td> <td>AWG 18</td> <td>1.3</td> <td>8 mm</td> </tr> <tr> <td>1 mm²</td> <td>AWG 18</td> <td>1.45</td> <td>8 mm</td> </tr> <tr> <td>1.5 mm²</td> <td>AWG 16</td> <td>1.75</td> <td>8 mm</td> </tr> <tr> <td>2.5 mm²</td> <td>AWG 14</td> <td>2.25</td> <td>6 mm</td> </tr> </tbody> </table>	Wire gauge		∅	Stripping length	0.14-0.37 mm ²	AWG 26-22	0.9	8 mm	0.5 mm ²	AWG 20	1.1	8 mm	0.75 mm ²	AWG 18	1.3	8 mm	1 mm ²	AWG 18	1.45	8 mm	1.5 mm ²	AWG 16	1.75	8 mm	2.5 mm ²	AWG 14	2.25	6 mm	
Wire gauge		∅	Stripping length																														
0.14-0.37 mm ²	AWG 26-22	0.9	8 mm																														
0.5 mm ²	AWG 20	1.1	8 mm																														
0.75 mm ²	AWG 18	1.3	8 mm																														
1 mm ²	AWG 18	1.45	8 mm																														
1.5 mm ²	AWG 16	1.75	8 mm																														
2.5 mm ²	AWG 14	2.25	6 mm																														
	0.5	09 15 000 6103	09 15 000 6203																														
	0.75	09 15 000 6105	09 15 000 6205																														
	1	09 15 000 6102	09 15 000 6202																														
	1.5	09 15 000 6101	09 15 000 6201																														
	2.5	09 15 000 6106	09 15 000 6206																														
gold plated	0.14-0.37	09 15 000 6124	09 15 000 6224																														
	0.5	09 15 000 6123	09 15 000 6223																														
	0.75	09 15 000 6125	09 15 000 6225																														
	1	09 15 000 6122	09 15 000 6222																														
	1.5	09 15 000 6121	09 15 000 6221																														
	2.5	09 15 000 6126	09 15 000 6226																														
F.O. contacts for 1 mm plastic fibre																																	
		20 10 001 3211	20 10 001 3221																														
																																	

06
45

Stock items in bold type

Features

- Suitable for Han D® crimp contacts
- High contact density

Technical characteristics

Specifications DIN EN 60 664-1
DIN EN 61 984

Approvals

Inserts

Number of contacts	17
Electrical data acc. to EN 61 984	10 A 160 V 2.5 kV 3
Rated current	10 A
Rated voltage	160 V
Rated impulse voltage	2.5 kV
Pollution degree	3
Pollution degree 2 also	10 A 250 V 4 kV 2

Rated voltage acc. to UL	250 V
Insulation resistance	≥ 10 ¹⁰ Ω
Material	polycarbonate
Limiting temperatures	-40 °C ... +125 °C
Flammability acc. to UL 94	V 0
Mechanical working life - mating cycles	≥ 500

Contacts

Material	copper alloy
Surface	
- hard-silver plated	3 μm Ag
- hard-gold plated	2 μm Au over 3 μm Ni
Contact resistance	≤ 3 mΩ
Crimp terminal	
- mm ²	0.14 ... 2.5 mm ²
- AWG	26 ... 14

Current carrying capacity

The current carrying capacity of the connectors is limited by the thermal load capability of the contact element material including the connections and the insulating parts. The derating curve is therefore valid for currents which flow constantly (non-intermittent) through each contact element of the connector evenly, without exceeding the allowed maximum temperature.

Measuring and testing techniques according to DIN EN 60 512-5

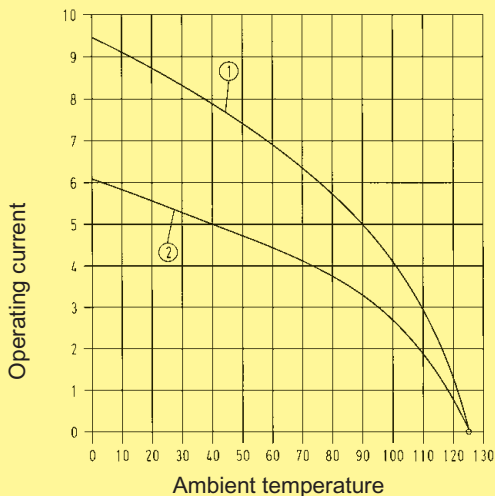

① 24 B hoods/housings with 6 modules; wire gauge: 1.5 mm²

② 24 B hoods/housings with 6 modules; wire gauge: 1.0 mm²

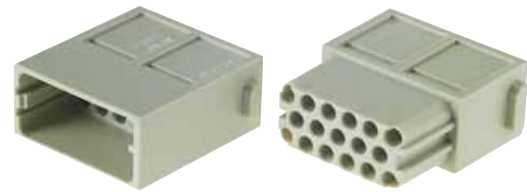

Number of contacts

17

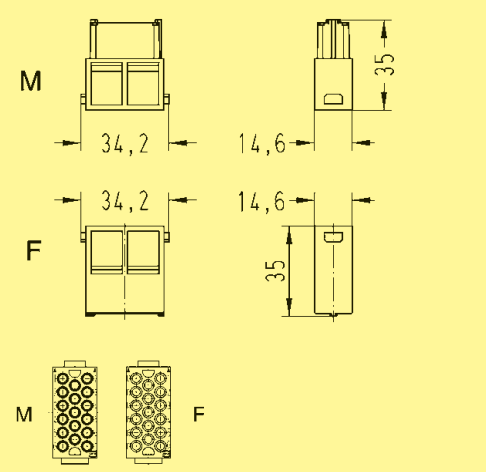

Identification	Part number		Drawing	Dimensions in mm
	Male insert (M)	Female insert (F)		
Crimp terminal Order crimp contacts separately	09 14 017 3001	09 14 017 3101	 <p>M</p> <p>F</p> <p>M</p> <p>F</p> <p>Contact arrangement view from termination side</p>	

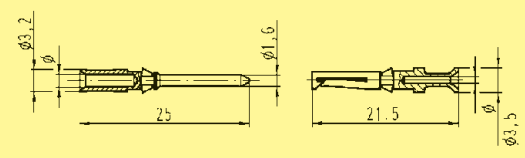
Han Modular

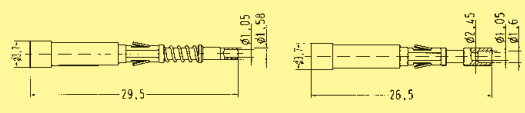
Identification	Wire gauge (mm ²)	Part number		Drawing	Dimensions in mm																												
		Male contact	Female contact																														
Crimp contacts Power contacts silver plated 	0.14-0.37 0.5 0.75 1 1.5 2.5	09 15 000 6104 09 15 000 6103 09 15 000 6105 09 15 000 6102 09 15 000 6101 09 15 000 6106	09 15 000 6204 09 15 000 6203 09 15 000 6205 09 15 000 6202 09 15 000 6201 09 15 000 6206		<table border="1"> <thead> <tr> <th colspan="2">Wire gauge</th> <th>∅</th> <th>Stripping length</th> </tr> </thead> <tbody> <tr> <td>0.14-0.37 mm²</td> <td>AWG 26-22</td> <td>0.9</td> <td>8 mm</td> </tr> <tr> <td>0.5 mm²</td> <td>AWG 20</td> <td>1.1</td> <td>8 mm</td> </tr> <tr> <td>0.75 mm²</td> <td>AWG 18</td> <td>1.3</td> <td>8 mm</td> </tr> <tr> <td>1 mm²</td> <td>AWG 18</td> <td>1.45</td> <td>8 mm</td> </tr> <tr> <td>1.5 mm²</td> <td>AWG 16</td> <td>1.75</td> <td>8 mm</td> </tr> <tr> <td>2.5 mm²</td> <td>AWG 14</td> <td>2.25</td> <td>6 mm</td> </tr> </tbody> </table>	Wire gauge		∅	Stripping length	0.14-0.37 mm ²	AWG 26-22	0.9	8 mm	0.5 mm ²	AWG 20	1.1	8 mm	0.75 mm ²	AWG 18	1.3	8 mm	1 mm ²	AWG 18	1.45	8 mm	1.5 mm ²	AWG 16	1.75	8 mm	2.5 mm ²	AWG 14	2.25	6 mm
Wire gauge		∅	Stripping length																														
0.14-0.37 mm ²	AWG 26-22	0.9	8 mm																														
0.5 mm ²	AWG 20	1.1	8 mm																														
0.75 mm ²	AWG 18	1.3	8 mm																														
1 mm ²	AWG 18	1.45	8 mm																														
1.5 mm ²	AWG 16	1.75	8 mm																														
2.5 mm ²	AWG 14	2.25	6 mm																														
F.O. contacts for 1 mm plastic fibre 		20 10 001 3211	20 10 001 3221																														

Stock items in bold type

Features

- Suitable for D-Sub crimp contacts
- High contact density
- Using of guiding pins (male and female) is recommended (see chapter 40).

Technical characteristics

Specifications	DIN EN 60 664-1 DIN EN 61 984
----------------	----------------------------------

Inserts

Number of contacts	25
Electrical data acc. to EN 61 984	4 A 50 V 0.8 kV 3
Rated current	4 A
Rated voltage	50 V
Rated impulse voltage	0.8 kV
Pollution degree	3
Pollution degree 2 also	4 A 160 V 2.5 kV 2
Insulation resistance	$\geq 10^{10} \Omega$
Material	polycarbonate
Limiting temperatures	-40 °C ... +125 °C
Flammability acc. to UL 94	V 0
Mechanical working life - mating cycles	≥ 500

Contacts

Crimp terminal	
- mm ²	0.08 ... 0.52 mm ²
- AWG	28 ... 20
turned contacts	Performance level 1 as per CECC 75 301-802, 500 mating cycles, 10 days 4 mixed gas test - IEC 60 512

Current carrying capacity

The current carrying capacity of the connectors is limited by the thermal load capability of the contact element material including the connections and the insulating parts. The derating curve is therefore valid for currents which flow constantly (non-intermittent) through each contact element of the connector evenly, without exceeding the allowed maximum temperature.

Measuring and testing techniques according to DIN EN 60 512-5

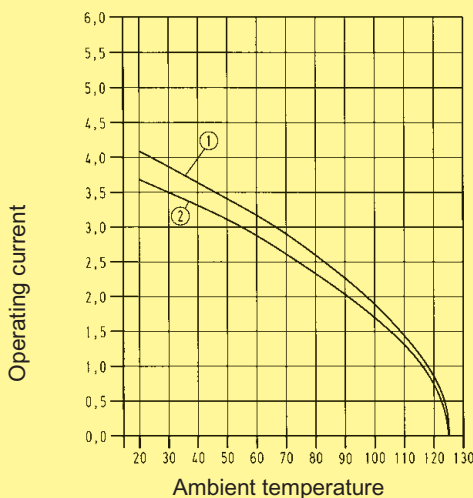

① 24 B hoods/housings with 6 modules; wire gauge: 0.5 mm² turned contacts

② 24 B hoods/housings with 6 modules; wire gauge: 0.5 mm² stamped contacts

Number of contacts

25

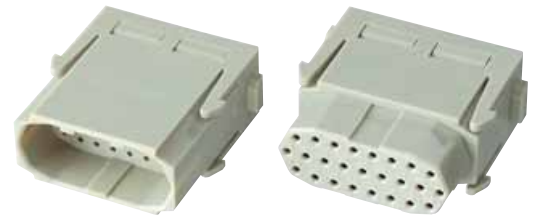

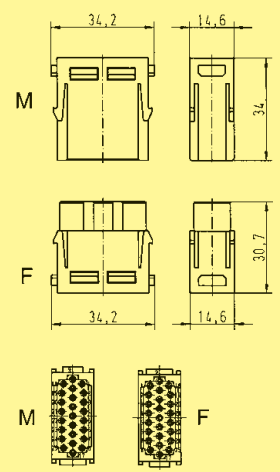
Identification	Part number		Drawing	Dimensions in mm
	Male insert (M)	Female insert (F)		
Crimp terminal Order crimp contacts separately	09 14 025 3001	09 14 025 3101	 <p> M F Contact arrangement view from termination side </p>	

Han Modular

Identification	Wire gauge (mm²)	Part number		Drawing	Dimensions in mm												
		Male contact	Female contact														
D-Sub crimp contacts 	0,08-0,21 0,13-0,33 0,33-0,52	61 03 000 0078 61 03 000 0094 61 03 000 0073	61 03 000 0080 61 03 000 0096 61 03 000 0074	<table border="1"> <thead> <tr> <th colspan="2">Wire gauge</th> <th>Stripping length</th> </tr> </thead> <tbody> <tr> <td>0.08-0.21 mm²</td> <td>AWG 28-24</td> <td>5 mm</td> </tr> <tr> <td>0.13-0.33 mm²</td> <td>AWG 26-22</td> <td>5 mm</td> </tr> <tr> <td>0.33-0.52 mm²</td> <td>AWG 22-20</td> <td>5 mm</td> </tr> </tbody> </table>	Wire gauge		Stripping length	0.08-0.21 mm²	AWG 28-24	5 mm	0.13-0.33 mm²	AWG 26-22	5 mm	0.33-0.52 mm²	AWG 22-20	5 mm	
Wire gauge		Stripping length															
0.08-0.21 mm²	AWG 28-24	5 mm															
0.13-0.33 mm²	AWG 26-22	5 mm															
0.33-0.52 mm²	AWG 22-20	5 mm															
Insertion / Removal tool for D-Sub crimp contacts		09 99 000 0368	09 99 000 0368														

Stock items in bold type

Features

- 9-pin D-Sub connector of the Han-Modular® system
- Ideal for the transmission of sensitive signals
- Compatible to crimp, solder or IDC termination
- Using of guiding pins (male and female) is recommended (see chapter 40).

Technical characteristics

Specifications	DIN EN 60 664-1 DIN EN 61 984
----------------	----------------------------------

Inserts

Number of contacts	9
Electrical data acc. to EN 61 984	5 A 50 V 0.8 kV 3
Rated current	5 A
Rated voltage	50 V
Rated impulse voltage	0.8 kV
Pollution degree	3
Insulation resistance	$\geq 10^{10} \Omega$
Material	polycarbonate
Limiting temperatures	-40 °C ... +125 °C
Flammability acc. to UL 94	V 0
Mechanical working life - mating cycles	≥ 500

Number of contacts

9

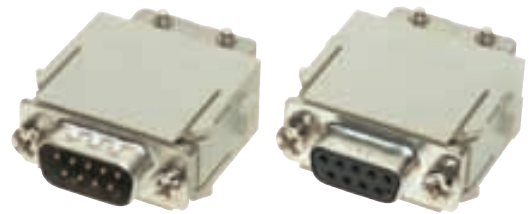

Identification	Part number		Drawing	Dimensions in mm						
	Male insert (M)	Female insert (F)								
<p>Crimp terminal Order crimp contacts separately (see page 06.49)</p>	09 14 009 3001	09 14 009 3101								
<p>Adapter module without D-Sub insert</p> <p>for one cable</p>	09 14 000 9930	09 14 000 9931								
<p>for two cables</p>	09 14 000 9932	09 14 000 9933								
<p>Screw terminal for RS 485-based bus systems with T-functionality</p>		09 14 009 3151	<p>Contact arrangement view from termination side</p> <table border="1"> <thead> <tr> <th>Signal</th> <th>Contact no.</th> </tr> </thead> <tbody> <tr> <td>A</td> <td>8</td> </tr> <tr> <td>B</td> <td>3</td> </tr> </tbody> </table>	Signal	Contact no.	A	8	B	3	
Signal	Contact no.									
A	8									
B	3									

Han Modular

Features

- According to USB 2.0 specification
- Simple and cost effective termination by plug in patch cable
- Cable tie strain relief

Technical characteristics

Specifications	DIN EN 60 664-1 DIN EN 61 984
----------------	----------------------------------







Inserts

Number of contacts	4
Electrical data acc. to EN 61 984	1 A 50 V 0.8 kV 3
Rated current	1 A
Rated voltage	50 V
Rated impulse voltage	0.8 kV
Pollution degree	3
Insulation resistance	$\geq 10^{10} \Omega$
Material	polycarbonate
Limiting temperatures	-40 °C ... +85 °C
Flammability acc. to UL 94	V 0
Mechanical working life - mating cycles	≥ 500

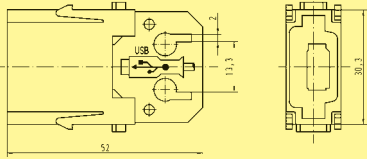
Number of contacts

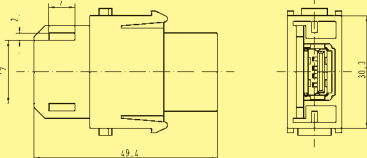
4

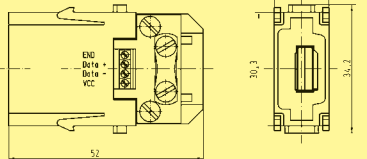

Identification	Part number		Drawing	Dimensions in mm
	Male insert (M)	Female insert (F)		
Module for patch cable Male insert 	09 14 001 4601			
Module for patch cable Female insert 		09 14 001 4701		
Module for screw termination Male insert 	09 14 001 4651			
Patch cable USB male / male Style A 	2 m 39 50 903 0050 5 m 39 50 903 0051	2 m 39 50 903 0050 5 m 39 50 903 0051		

Han
Modular

Features

- Compatible to IEEE 1394
- Simple and cost effective termination by plug in patch cable
- Cable tie strain relief

Technical characteristics

Specifications	DIN EN 60 664-1 DIN EN 61 984
----------------	----------------------------------



Inserts

Number of contacts	6
Electrical data acc. to EN 61 984	1 A 50 V 0.8 kV 3
Rated current	1 A
Rated voltage	50 V
Rated impulse voltage	0.8 kV
Pollution degree	3
Insulation resistance	$\geq 10^{10} \Omega$
Material	polycarbonate
Limiting temperatures	-40 °C ... +85 °C
Flammability acc. to UL 94	V 0
Mechanical working life - mating cycles	≥ 500

Number of contacts

6

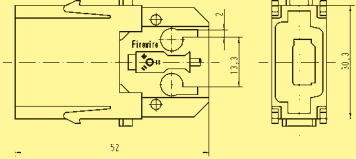

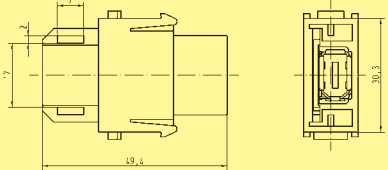
Identification	Part number		Drawing	Dimensions in mm
	Male insert (M)	Female insert (F)		
Module for patch cable Male insert 	09 14 001 4611			
Module for patch cable Female insert 		09 14 001 4711		

Han
Modular

Features

- Single module with standard shielded RJ45 plug and jack
- Cat 5e for all data pairs (all 8 pins)
- Conforming to the RoHS directive
- The RJ45 inserts are protected by a reliable plastic insulator

Technical characteristics

Specifications	DIN EN 60 664-1 DIN EN 61 984
----------------	----------------------------------

Inserts

Number of contacts	8
Electrical data acc. to EN 61 984	1 A 50 V 0.8 kV 3
Rated current	1 A
Rated voltage	50 V
Rated impulse voltage	0.8 kV
Pollution degree	3
Insulation resistance	≥ 10 ¹⁰ Ω
Material	polycarbonate
Limiting temperatures	-40 °C ... +85 °C
Flammability acc. to UL 94	V 0
Mechanical working life - mating cycles	≥ 500

Module with RJ45 terminal

Stranded wire diameter	0.89 ... 0.99 mm
Wire gauge	AWG 24 ... 26
Material	polycarbonate
Limiting temperatures	-40 °C ... +70 °C
Flammability acc. to UL 94	V 0
Stranded wire diameter	0.94 ... 1.07 mm
Wire gauge	AWG 22 ... 24
Material	polycarbonate
Limiting temperatures	-40 °C ... +70 °C
Flammability acc. to UL 94	V 0

RJ45 patch cable

Cable type	8 AWG 26/7 stranded
Material	PUR / yellow
Limiting temperatures	-40 °C ... +70 °C

Number of contacts

8

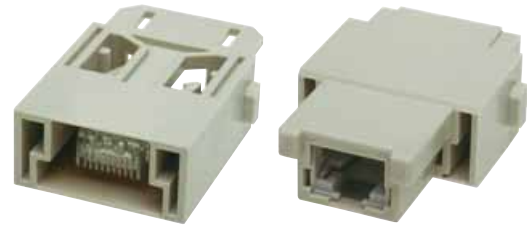

Identification	Part number		Drawing	Dimensions in mm
	Male insert (M)	Female insert (F)		
for RJ45 plugs (please order separately)	09 14 001 4622 09 12 000 9958 09 12 000 9957			
for patch cable	09 14 001 4621			
Gender Changer for patch cable		09 14 001 4721		
RJ45 patch cable				
Length	1.5 m 2 m 3 m 5 m 7 m 10 m 15 m 20 m	09 47 777 7015 09 47 777 7020 09 47 777 7030 09 47 777 7050 09 47 777 7070 09 47 777 7100 09 47 777 7150 09 47 777 7200		

Han
Modular

Features

- Shielding bus separate from housing potential
- Ideal for the transmission of sensitive signals (e.g. bus signals)
- Usable for Gigabit Ethernet Cat. 6

Technical characteristics

Specifications	DIN EN 60 664-1 DIN EN 61 984
----------------	----------------------------------

Inserts

Number of contacts	8
Insulation resistance	$\geq 10^{10} \Omega$
Material	polycarbonate
Limiting temperatures	-40 °C ... +125 °C
Flammability acc. to UL 94	V 0
Mechanical working life	
- mating cycles	≥ 500

GigaBit contacts

Number of contacts	8 + shielding
Electrical data	
acc. to EN 61 984	5 A 50 V 0.8 kV 3
Rated current	5 A
Rated voltage	50 V
Rated impulse voltage	0.8 kV
Pollution degree	3

Material

- Insulator	polycarbonate
- Outer conductor	zinc alloy
Contact resistance	$\leq 4 \text{ m}\Omega$
Limiting temperatures	-40 °C ... +85 °C
Flammability acc. to UL 94	V 0
Outer surface finish	nickel
Cable diameter	5 ... 12 mm

D-Sub crimp contacts

Crimp terminal	
- mm ²	0.08 ... 0.52 mm ²
- AWG	28 ... 20
turned contacts	Performance level 1

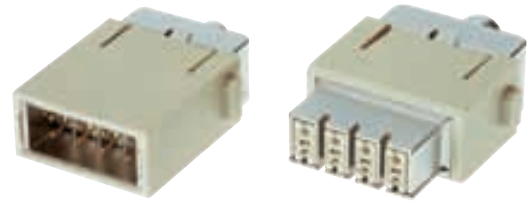

Number of contacts

1 (8)

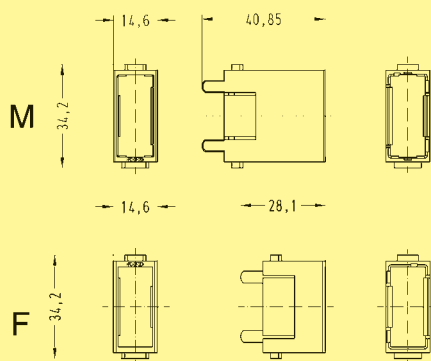

Identification	Part number		Drawing	Dimensions in mm
	Male insert (M)	Female insert (F)		
Han® GigaBit module 	09 14 001 3011	09 14 001 3111		

Han Modular

Identification	Wire gauge (mm²)	Part number		Drawing	Dimensions in mm												
		Male contact	Female contact														
GigaBit contacts 8 + shielding Order crimp contacts separately 		09 14 008 3011	09 14 008 3111														
D-Sub crimp contacts 	0.08-0.21 0.13-0.33 0.33-0.52	61 03 000 0078 61 03 000 0094 61 03 000 0073	61 03 000 0080 61 03 000 0096 61 03 000 0074	<table border="1"> <thead> <tr> <th colspan="2">Wire gauge</th> <th>Stripping length</th> </tr> </thead> <tbody> <tr> <td>0.08-0.21 mm²</td> <td>AWG 28-24</td> <td>5 mm</td> </tr> <tr> <td>0.13-0.33 mm²</td> <td>AWG 26-22</td> <td>5 mm</td> </tr> <tr> <td>0.33-0.52 mm²</td> <td>AWG 22-20</td> <td>5 mm</td> </tr> </tbody> </table>	Wire gauge		Stripping length	0.08-0.21 mm²	AWG 28-24	5 mm	0.13-0.33 mm²	AWG 26-22	5 mm	0.33-0.52 mm²	AWG 22-20	5 mm	
Wire gauge		Stripping length															
0.08-0.21 mm²	AWG 28-24	5 mm															
0.13-0.33 mm²	AWG 26-22	5 mm															
0.33-0.52 mm²	AWG 22-20	5 mm															

Stock items in bold type

Identification	Part number	Drawing	Dimensions in mm
Crimp flange			
	D1 D2		
	3.0 4.0	61 03 000 0062	
	3.5 4.5	61 03 000 0063	
	4.0 5.0	61 03 000 0064	
	4.5 5.5	61 03 000 0065	
	5.0 6.0	61 03 000 0066	
	5.5 6.5	61 03 000 0166	
	6.0 7.0	61 03 000 0067	
	6.5 7.5	61 03 000 0068	
	7.0 8.0	61 03 000 0069	
	7.5 8.5	61 03 000 0070	
	8.0 9.0	61 03 000 0071	
	8.5 9.5	61 03 000 0165	
	9.0 10.0	61 03 000 0072	
Crimp ferrule			
	D3 D4		
	5.0 6.0	61 03 000 0045	
	5.5 6.5	61 03 000 0046	
	6.0 7.0	61 03 000 0047	
	6.5 7.5	61 03 000 0048	
	7.0 8.0	61 03 000 0049	
	7.5 8.5	61 03 000 0050	
	8.0 9.0	61 03 000 0051	
	8.5 9.5	61 03 000 0052	
	9.0 10.0	61 03 000 0053	
	9.5 10.5	61 03 000 0054	
	10.0 11.0	61 03 000 0055	
	10.5 11.5	61 03 000 0056	
	11.0 12.0	61 03 000 0057	
	11.5 12.5	61 03 000 0058	
	12.0 13.0	61 03 000 0142	
	12.5 13.5	61 03 000 0059	
	13.0 14.0	61 03 000 0127	
Cable clamp			
	cable diameter approx. 5 ... 7 mm	61 03 000 0141	
	cable diameter approx. 7 ... 10 mm	61 03 000 0044	
	cable diameter approx. 10 ... 12 mm	61 03 000 0143	

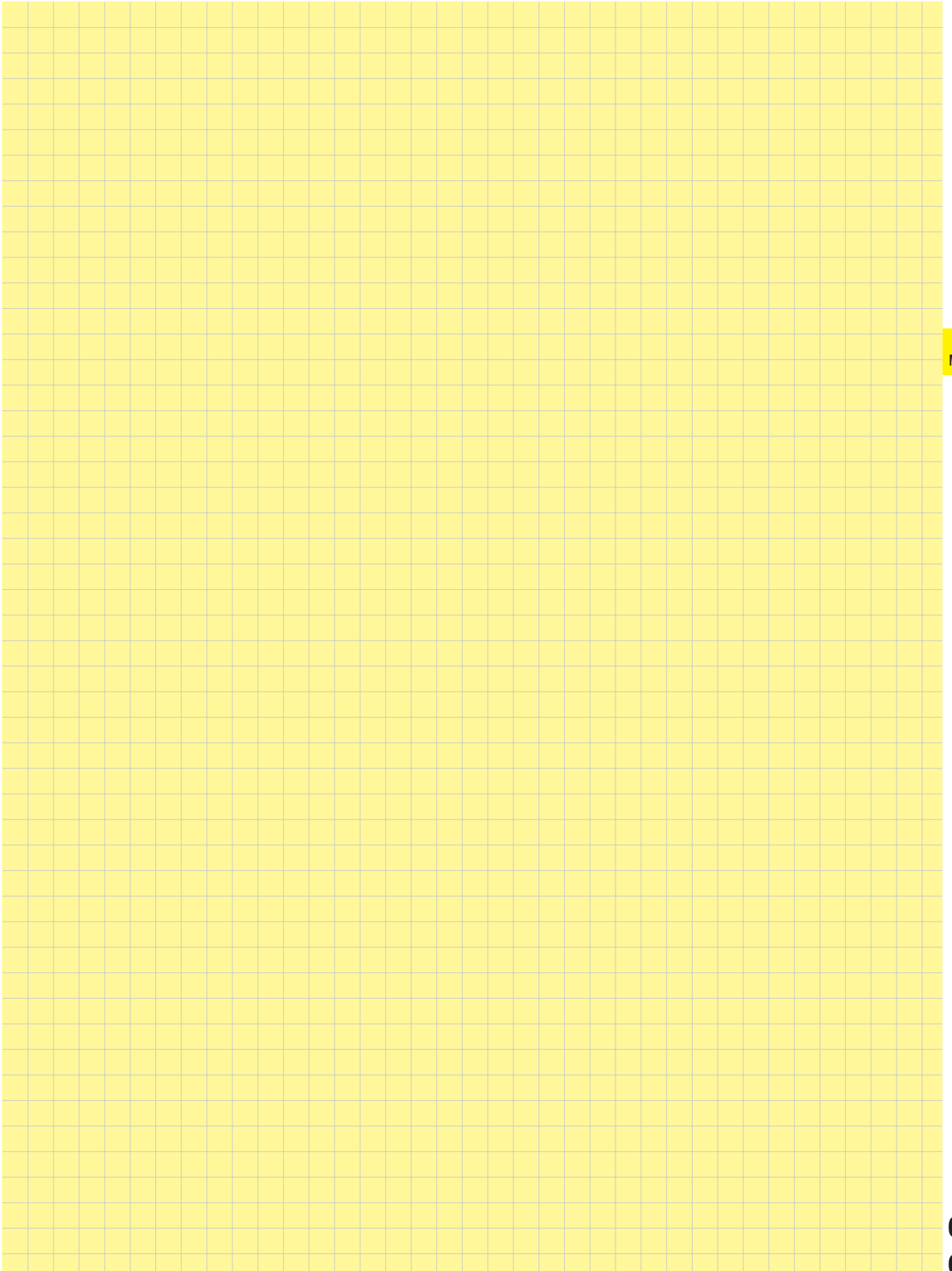

Features

- Shielding bus separate from housing potential
- Perfect for transmission of sensitive signals (eg. bus signals)
- The four pole Han® Quintax contact is suitable for Ethernet Cat. 5e and PROFIBUS when diagonally wiring of the data pairs.

Technical characteristics

Specifications	DIN EN 60 664-1 DIN EN 61 984
----------------	----------------------------------

Approvals	
-----------	---

Inserts

Number of contacts	2
Insulation resistance	$\geq 10^{10} \Omega$
Material	polycarbonate
Limiting temperatures	-40 °C ... +125 °C
Flammability acc. to UL 94	V 0
Mechanical working life	
- mating cycles	≥ 500

Quintax contacts

Number of contacts	
- Quintax	4 + shielding
- High Density Quintax	8 + shielding
Electrical data	
acc. to EN 61 984	
- Quintax	10 A 50 V 0.8 kV 3
- High Density Quintax	5 A 50 V 0.8 kV 3
Rated current	10 A / 5 A
Rated voltage	50 V
Rated impulse voltage	0.8 kV
Pollution degree	3
Material	
- Insulator	polycarbonate
- Outer conductor	zinc alloy
Contact resistance	$\leq 4 \text{ m}\Omega$
Limiting temperatures	-40 °C ... +85 °C
Flammability acc. to UL 94	V 0
Outer surface finish	nickel
Cable diameter	3 - 9.5 mm

Han D® contacts

Material	copper alloy
Surface	
- hard-gold plated	2 μm Au over 3 μm Ni
Contact resistance	$\leq 3 \text{ m}\Omega$
Crimp terminal	
- mm ²	0.14 - 2.5 mm ²
- AWG	26 - 14

D-Sub crimp contacts

Crimp terminal	
- mm ²	0.08 - 0.52 mm ²
- AWG	28 - 20
turned contacts	Performance level 1

Number of contacts

2

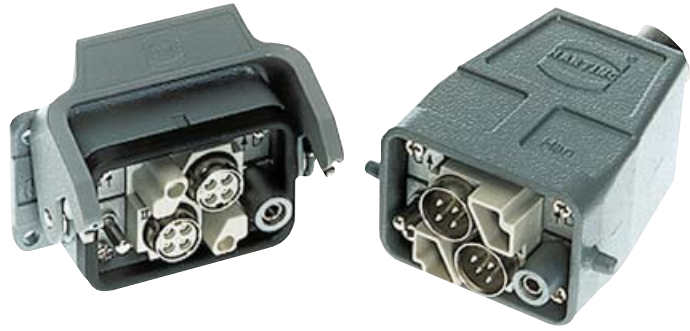

Identification	Part number		Drawing	Dimensions in mm
	Male insert (M)	Female insert (F)		
<p>Crimp terminal</p>	09 14 002 3001	09 14 002 3101	<p>M</p> <p>F</p> <p>Contact arrangement view from termination side</p>	
<p>Quintax metal adapter option</p>	09 14 000 9915	09 14 000 9915		

Han Modular

Identification	Wire gauge (mm ²)	Part number		Drawing	Dimensions in mm
		Male contact	Female contact		
<p>Quintax contact 4 + shielding Han D® crimp contacts</p>		09 15 004 3013	09 15 004 3113		
<p>Han D® Crimp contact gold plated</p>	0.14-0.37 0.5 0.75 1 1.5 2.5	09 15 000 6124 09 15 000 6123 09 15 000 6125 09 15 000 6122 09 15 000 6121 09 15 000 6126	09 15 000 6224 09 15 000 6223 09 15 000 6225 09 15 000 6222 09 15 000 6221 09 15 000 6226		
<p>High Density Quintax contact 8 + shielding Han® D-Sub contacts</p>		09 15 008 3013	09 15 008 3113		
<p>D-Sub crimp contact</p>	0.08-0.21 0.13-0.33 0.33-0.52	61 03 000 0078 61 03 000 0094 61 03 000 0073	61 03 000 0080 61 03 000 0096 61 03 000 0074		

Order crimp contacts separately

Stock items in bold type

Features

- Well known Quintax concept
- Suitable for contacts with large diameters
- Han E[®] coax is applicable to the ETCS Eurobalise cable

Technical characteristics

Specifications DIN EN 60 664-1
 DIN EN 61 984

Approvals

Inserts

Number of contacts 2

Insulation resistance ≥ 10¹⁰ Ω

Material polycarbonate

Limiting temperatures -40 °C ... +125 °C

Flammability acc. to UL 94 V 0

Mechanical working life

- mating cycles ≥ 500

RF transmission characteristics

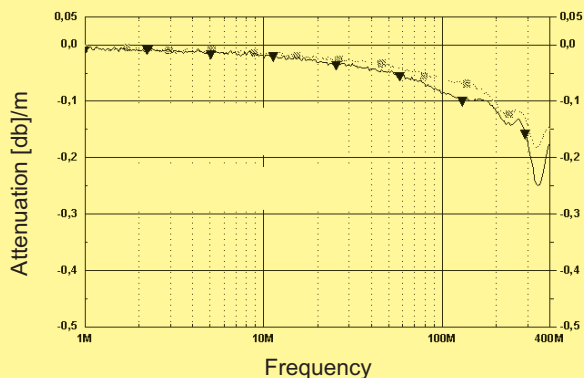

75 Ω cable

75 Ω cable with Han D[®] Coax

75 Ω coax cable
 diameter shielding: 7.3 mm

Han E [®] Coax with ETCS S21 Eurobalise cable (4 mm ²)	27 MHz
Return loss [db]	35.4
Attenuation [db]	0.017

Han E [®] Coax with RG 213 cable (2.5 mm ²)	200 MHz	500 MHz	1.0 GHz	1.2 GHz	1.5 GHz	2.0 GHz	2.5 GHz
Return loss [db]	23.8	21.1	>18.7	>17.7	>16.4	>14.1	>12.0
Attenuation [db]	0.07	0.11	0.17	0.2	<0.23	<0.53	<2.0

Coax contacts

Number of contacts 1 + shielding

Electrical data acc. to EN 61 984

- Han D[®] Coax **10 A 50 V 0.8 kV 3**

- Han E[®] Coax **16 A 50 V 0.8 kV 3**

Rated current 10 A / 16 A

Rated voltage 50 V

Rated impulse voltage 0.8 kV

Pollution degree 3

Impedance

- Han D[®] Coax 75 Ω

- Han E[®] Coax 50 Ω

Material

- Insulator polycarbonate

- Outer conductor zinc alloy

Contact resistance ≤ 4 mΩ

Limiting temperatures -40 °C ... +85 °C

Flammability acc. to UL 94 V 0

Outer surface finish nickel

Cable diameter 3 - 9.5 mm

Han D[®] contacts

Material copper alloy

Surface

- hard-gold plated 2 μm Au over 3 μm Ni

Contact resistance ≤ 3 mΩ

Crimp terminal

- mm² 0.14 - 2.5 mm²

- AWG 26 - 14

Han E[®] contacts

Material copper alloy

Surface

- hard-gold plated 2 μm Au over 3 μm Ni

Contact resistance ≤ 1 mΩ

Crimp terminal

- mm² 0.14 - 5.5 mm²



- AWG 26 - 10

Number of contacts

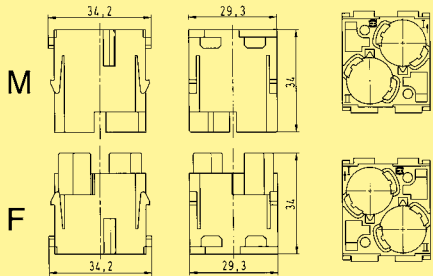
2

Identification	Part number		Drawing	Dimensions in mm
	Male insert (M)	Female insert (F)		
Crimp terminal 	09 14 002 3001	09 14 002 3101	 <p>M</p> <p>F</p> <p>Contact arrangement view from termination side</p>	

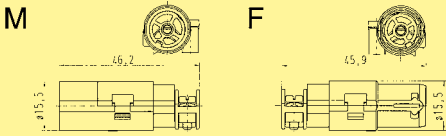
Han Modular

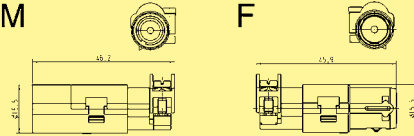
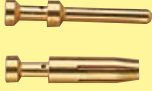
Identification	Wire gauge (mm²)	Part number		Drawing	Dimensions in mm
		Male contact	Female contact		
Han® D Coax contact 1 + shielding, 75 Ω Han D® crimp contacts 		09 15 001 3013	09 15 001 3113	 <p>M</p> <p>F</p>	
Han D® Crimp contact gold plated 	0.14-0.37 0.5 0.75 1 1.5 2.5	09 15 000 6124 09 15 000 6123 09 15 000 6125 09 15 000 6122 09 15 000 6121 09 15 000 6126	09 15 000 6224 09 15 000 6223 09 15 000 6225 09 15 000 6222 09 15 000 6221 09 15 000 6226		
Han® E Coax contact 1 + shielding, 50 Ω Han E® crimp contacts 		09 15 001 3023	09 15 001 3123	 <p>M</p> <p>F</p>	
Han E® contacts gold plated 	0.14-0.37 0.5 0.75 1 1.5 2.5 4 5.5	09 33 000 6117 09 33 000 6122 09 33 000 6115 09 33 000 6118 09 33 000 6116 09 33 000 6123 09 33 000 6119 09 33 000 6139	09 33 000 6217 09 33 000 6222 09 33 000 6215 09 33 000 6218 09 33 000 6216 09 33 000 6223 09 33 000 6221 09 33 000 6239		

Order crimp contacts separately

Stock items in bold type

Features

- Suitable for FOC and coaxial contacts acc. to DIN 41 626
- Using of guiding pins (male and female) is recommended (see chapter 40).

Contact arrangement

according to following matrix

Contacts	Male insert (M) 09 14 004 4501	Female insert (F) 09 14 004 4512
Coaxial contacts	09 14 000 62xx	09 14 000 61xx
F.O. contacts	20 10 xxx 421x	20 10 xxx 422x

Coaxial cables (group 2)

Wires	Shell ∅	Internal wire ∅	Attenuation db/100 m at		
			100 MHz	200 MHz	800 MHz
50 Ω					
RG 174 / U	2.5	0.48			84
RG 188 A / U	2.6	0.54	29	40	
RG 316 / U	2.5	0.54		40	
75 Ω					
RG 179 B / U	2.55	0.3		41	
RG 187 A / U	2.7	0.3		41	

Technical characteristics

Specifications DIN EN 60 664-1
DIN EN 61 984

Approvals

Inserts

Number of contacts 4
Insulation resistance $\geq 10^{10} \Omega$
Material polycarbonate
Limiting temperatures $-40 \text{ °C} \dots +125 \text{ °C}$
Flammability acc. to UL 94 V 0
Mechanical working life
- mating cycles ≥ 500

Contacts

Coaxial contacts

Material copper alloy
Surface
- hard-gold plated demand level 2
Impedance 50 Ω / 75 Ω
Contact resistance
- Internal wire $\leq 10 \text{ m}\Omega$
- Outer conductor $\leq 3 \text{ m}\Omega$
Rated current 1.5 A
Rated voltage 50 V

F.O. contacts

Fibre type Glas fibre (GI)
Attenuation < 1.5 dB

F.O. contacts

Fibre type Polymer Optical Fibre (POF)
Attenuation < 2.5 dB

Assembly instructions

Stripping de-
scription

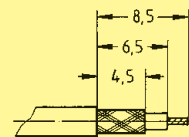

Assembly details
for coaxial contacts

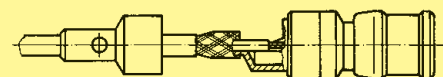

Crimp barrel solder

Solder temperature approx. 300 °C
Solder duration approx. 2 s

Due to the closed entry design of female insert the upper part has to be removed by screw driver (7 mm) before extracting the contacts

Number of contacts

4



Identification	Part number		Drawing	Dimensions in mm
	Male insert (M)	Female insert (F)		
Multicontact module acc. to DIN 41 626 Order contacts separately	09 14 004 4501	09 14 004 4512	<p> M F Contact arrangement view from termination side </p>	

Han
Modular

Identification	Impedance	Part number		Drawing	Dimensions in mm
Coaxial contacts acc. to DIN 41 626* Solder / crimp contact 	50 Ω 75 Ω	09 14 000 6211 09 14 000 6221	09 14 000 6111 09 14 000 6121	<p>For cable group 2 flexible wires</p>	
F.O. contacts acc. to DIN 41 626 for SI fibre (HCS®) 200/230 μm for GI fibre 50/125 μm or 62.5/125 μm ceramic ferrule for 1 mm plastic fibre 		20 10 230 4211 20 10 125 4212 20 10 001 4211	20 10 230 4221 20 10 125 4222 20 10 001 4221		

* Using of guiding pins is imperative (see chapter 40).

Stock items in bold type

Features

- Suitable for coaxial contacts acc. to D-Sub (DIN 41 652)
- Using of guiding pins (male and female) is recommended (see chapter 40).

Contact arrangement

according to following matrix

Contacts	Male insert (M) 09 14 004 4501	Female insert (F) 09 14 004 4513
Coaxial contacts	09 14 000 62xx	09 14 000 61xx
Coaxial contacts	09 69 28x 5xxx	09 69 18x 5xxx

Technical characteristics

Specifications DIN EN 60 664-1
 DIN EN 61 984

Approvals  

Inserts

Number of contacts 4
Insulation resistance $\geq 10^{10} \Omega$
Material polycarbonate
Limiting temperatures -40 °C ... +125 °C
Flammability acc. to UL 94 V 0
Mechanical working life
- mating cycles ≥ 500

Contacts

Coaxial contacts
Material copper alloy
Surface
- hard-gold plated demand level 2, S4
Impedance 50 Ω / 75 Ω
Contact resistance
- Internal wire $\leq 10 \text{ m}\Omega$
- Outer conductor $\leq 3 \text{ m}\Omega$
Rated current 1.5 A
Rated voltage 50 V

Number of contacts

4

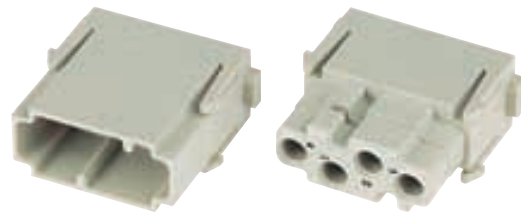

Identification	Part number		Drawing	Dimensions in mm
	Male insert (M)	Female insert (F)		
Multicontact module acc. to D-Sub Order contacts separately	09 14 004 4501	09 14 004 4513	<p>M</p> <p>F</p> <p>Contact arrangement view from termination side</p>	

Han
Modular

Identification	Impedance	Part number		Drawing	Dimensions in mm
Coaxial contacts acc. to D-Sub Performance level 2 Solder / solder contact	50 Ω	09 14 000 6215	09 14 000 6115		RG 58
Solder / crimp contact Performance level S4	50 Ω 50 Ω 50 Ω 75 Ω	09 69 281 5140 09 69 281 5141 09 69 281 5143 09 69 281 5230	09 69 181 5140 09 69 181 5141 09 69 181 5143 09 69 181 5230		RG 174 U, 188 AU, 316 U RG 178 BU, 196 AU, 404 U RG 58 CU, 141 AU RG 179 BU, 187 AU
Crimp / crimp terminal Performance level S4	50 Ω 75 Ω	09 69 282 5140 09 69 282 5230	09 69 182 5140 09 69 182 5230		RG 174 U, 188 AU, 316 U RG 179 BU, 187 AU

Due to the closed entry design of female insert the upper part has to be removed by screw driver (7 mm) before extracting the contacts

Stock items in bold type

Features

- For the transmission of clean and dry compressed
- Female contacts with / without shut off
- Removal of tubes from pre-assembled pneumatic contacts is possible

Shut off principle:

In the disconnected position the spring integrated in the female contact is active, thus the O-ring of the valve seals the opening of the air-way. During the mating process, when the defined depth of insertion is reached the male contact presses on the valve head and moves it backwards against the spring tension, so that the air-way opens.

Using of guiding pins in connection with pneumatic modules is imperative.

In addition to this guiding pins guarantee a coding, if pneumatic modules are used exclusively.

Technical characteristics

Approvals 

Inserts *

Number of contacts	2
Colour	blue
Material	polycarbonate
Limiting temperatures	-40 °C ... +80 °C
Flammability acc. to UL 94	V 0
Mechanical working life - mating cycles	≥ 500

Contacts

Material	delrin acetal
Colour	black
Tube termination - Internal diameter (ID)	6.0 mm / 1/4"
Working pressure	up to 8 bar / 116 psi

Sealing

Material	Buna-N
----------	--------

Shut off valve

Material	Polypropylen
----------	--------------

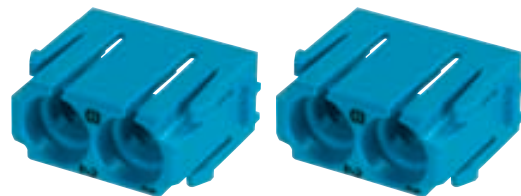

Number of contacts

2

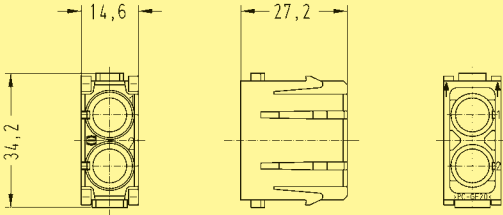

Identification	Part number		Drawing	Dimensions in mm
	Male insert (M)	Female insert (F)		
for 6 mm Order contacts separately 	09 14 002 4501*	09 14 002 4501*	 <p>Contact arrangement view from termination side</p>	

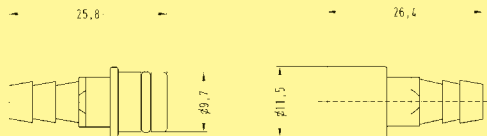
Han
Modular

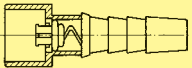
Identification	ID (mm)	Part number		Drawing	Dimensions in mm
		Male contact	Female contact		
Pneumatic contacts without shut off for tube internal diameter (ID) 	6.0	09 14 000 6174	09 14 000 6274	 <p>Male contact Female contact</p>	
Pneumatic contacts with shut off for tube internal diameter (ID) 	6.0		09 14 000 6279	 <p>female contact with shut off in closed position</p>	

* Using of guiding pins is imperative (see chapter 40).

Features

- For the transmission of clean and dry compressed
- Female contacts with / without shut off
- Removal of tubes from pre-assembled pneumatic contacts is possible

Shut off principle:

In the disconnected position the spring integrated in the female contact is active, thus the O-ring of the valve seals the opening of the air-way. During the mating process, when the defined depth of insertion is reached the male contact presses on the valve head and moves it backwards against the spring tension, so that the air-way opens.

Using of guiding pins in connection with pneumatic modules is imperative.

In addition to this guiding pins guarantee a coding, if pneumatic modules are used exclusively.

Technical characteristics

Approvals



Inserts *

Number of contacts	3
Colour	blue
Material	polycarbonate
Limiting temperatures	-40 °C ... +80 °C
Flammability acc. to UL 94	V 0
Mechanical working life - mating cycles	≥ 500

Contacts

Material	delrin acetal
Colour	black
Tube termination - Internal diameter (ID)	1.6 mm / 1/16" 3.0 mm 4.0 mm / 1/8"
Working pressure	up to 8 bar / 116 psi

Sealing

Material	Buna-N
----------	--------

Shut off valve

Material	Polypropylen
----------	--------------



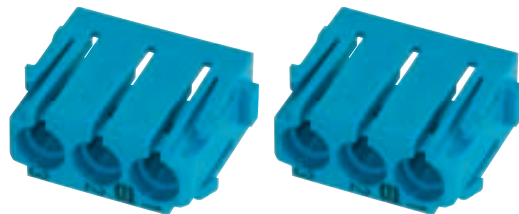

Number of contacts

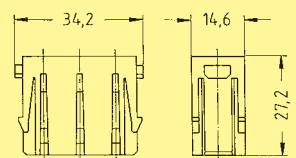
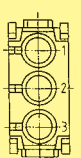
3

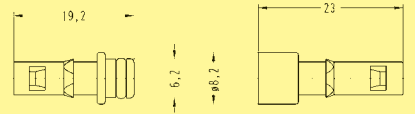
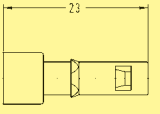
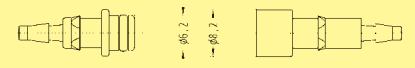
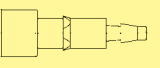

Identification	Part number		Drawing	Dimensions in mm
	Male insert (M)	Female insert (F)		
for 1.6; 3; 4 mm Order contacts separately 	09 14 003 4501*	09 14 003 4501*	 <p>Contact arrangement view from termination side</p>	

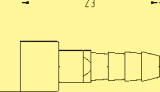
Han Modular

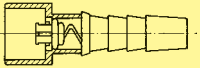
Identification	ID (mm)	Part number		Drawing	Dimensions in mm
		Male contact	Female contact		
Pneumatic contacts without shut off for tube internal diameter (ID) 	1.6	09 14 000 6151	09 14 000 6251		
	3.0	09 14 000 6152	09 14 000 6252		
	4.0	09 14 000 6153	09 14 000 6253		
Pneumatic contacts with shut off for tube internal diameter (ID) 	1.6 3.0 4.0		09 14 000 6256 09 14 000 6257 09 14 000 6258	 <p>female contact with shut off in closed position</p>	

* Using of guiding pins is imperative (see chapter 40).

Stock items in bold type

Features

- Suitable for SC contacts
- For GI-Fibre 50 - 62.5 / 125µm
- Using of guiding pins (male and female) is recommended (see chapter 40).

Technical characteristics

Inserts

Number of contacts	4
Insertion loss	< 0.5 dB
Material	polycarbonate
Limiting temperatures	-40 °C ... +85 °C
Flammability acc. to UL 94	V 0
Mechanical working life	
- mating cycles	≥ 500

Assembly instructions

Male insert (09 14 004 4701)

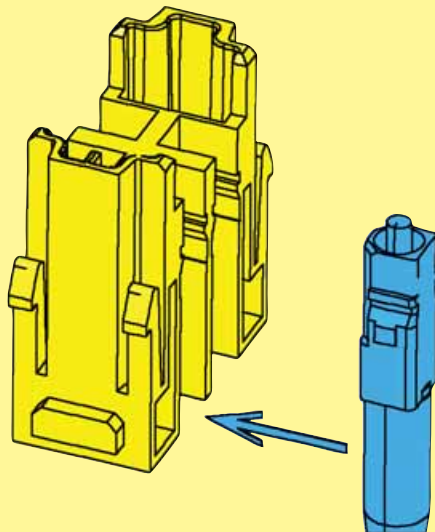

Assemble the SC contact

Push the SC contact from the side into the relevant insert

Female insert (09 14 004 4711)

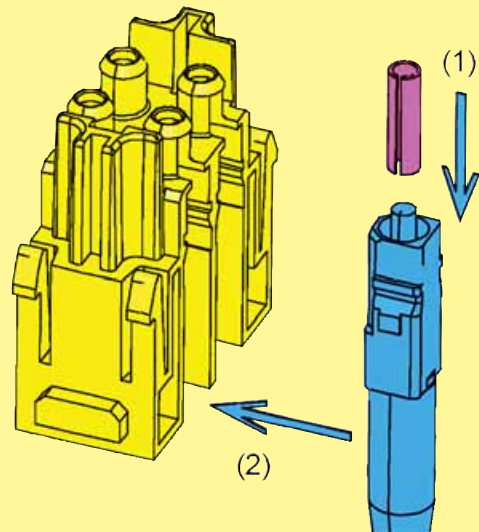

Assemble the SC contact

Push the centering ferrule (included in delivery) on the SC contact

Push the SC contact from the side into the relevant insert

Number of contacts

4

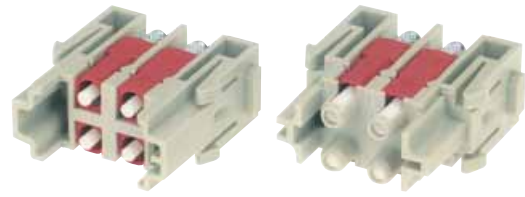

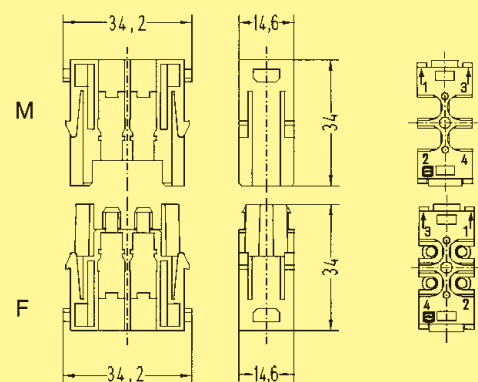
Identification	Part number		Drawing	Dimensions in mm
	Male insert (M)	Female insert (F)		
SC module Order contacts separately 	09 14 004 4701	09 14 004 4711*	 <p>M</p> <p>F</p> <p>Contact arrangement view from termination side</p>	

Han Modular

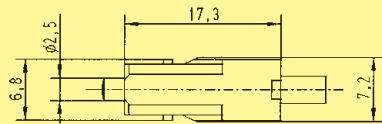
Identification	Part number		Drawing	Dimensions in mm
	Male contact	Female contact		
SC contact for GI fibre 50/125 µm or 62.5/125 µm ceramic ferrule  for SI fibre (HCS®) 200/230 µm with quick assembly technique for 1 mm POF	20 10 125 5211	20 10 125 5211		
		20 10 230 5211		
	20 10 001 5217	20 10 001 5217		

06
75

* The female inserts are equipped with centering ferrules. 4 ferrules are included in delivery range.

Stock items in bold type

Features

- Signal pre-processing and conversion do fit into the connector
- Individual combination of input and output modules for optimal signal pre-processing
- Minimum size for integration in Han® industrial connectors (Han-Modular® and Han-Snap®)
- Economy of space by reduction the number of terminal blocks and interface modules in the switch cabinet

Han
Modular

General description

The Han-Elisa® modules are a flexible I/O system - directly in the connector.

The input and output modules are developed for 1 or 2 channels and can be combined variously and flexible for optimal signal pre-processing. Within the product family modules are available for current/voltage conversion, temperature, relay and timer.

Due to the minimized size thes modules can be integrated into the Han-Modular® and Han-Snap® system.

Signal pre-processing and conversion do fit into the connector and this will reduce installation space for terminal blocks and the number of interface modules. So the switch cabinets can be made smaller.

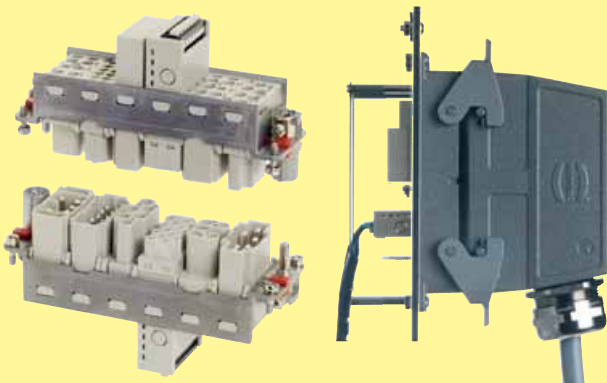

Technical characteristics

Power supply

(combination input and output module)

Supply voltage	24 V (-10 % ... +25 %)
Current consumption	< 0.08 A
Power consumption	< 2 W
Total transmission error	< 0.2 %

Product matrix and possible combinations

input module (male)	output module (female)	Relay Different versions	Optocoupler Different versions	Output current 4 ... 20 mA galvanically isolated	Output voltage 0 ... 10 V galvanically isolated
Timing		○	○		
Connecting 1:1		○	○		
Temperature Pt100 Different temperature ranges				●	●
Temperature thermo element type J, K Different temperature ranges				○	○
Input current 4 ... 20 mA				○	○
Input voltage 0 ... 10 V				○	○

- = on request
- = available

Features

- Minimum size for integration in Han[®] industrial connectors (Han-Modular[®] and Han-Snap[®])
- Economy of space by reduction the number of terminal blocks and interface modules in the switch cabinet
- Male module for signal input

Technical characteristics

Inserts

Sensor	Pt100 acc. to IEC 751
Termination technology	2-, 3-, 4 wire technology
Sensor input current	0.8 mA, constant
Conductor resistance, max. permissible	10 Ω per conductor
Min. measuring range	100 °C
Open circuit detection	integrated

Material	polycarbonate / LCP
Termination	Cage-clamp terminal
- mm ²	0.14 ... 1.5 mm ²
- AWG	26 ... 16

Power diagnostic	LED (green)
------------------	-------------

Temperature range

Working temperature	-20 °C ... +65 °C
Stock temperature	-40 °C ... +85 °C



Pt100 Input module

Identification	Part number Male insert (M)	Drawing	Dimensions in mm
Temperature module Pt100			
Measuring range	<p>0 ... 100 °C 20 75 108 1101</p> <p>0 ... 200 °C 20 75 108 1103</p>	<p>Input</p>	
Additional measuring ranges on request			

Han
Modular

Features

- Minimum size for integration in Han[®] industrial connectors (Han-Modular[®] and Han-Snap[®])
- Economy of space by reduction the number of terminal blocks and interface modules in the switch cabinet
- Female module for signal output

Technical characteristics

Inserts

Supply voltage	24 V (-10 % ... +25 %)
Load I_{out}	< 500 Ω
Load U_{out}	≥ 10 k Ω
Residual ripple	< 20 mV (500 Ω)
Step response (0 ... 99 %)	< 30 ms

Material	polycarbonate / LCP
Termination	Cage-clamp terminal
- mm ²	0.14 ... 1.5 mm ²
- AWG	26 ... 16

Power diagnostic	LED (green)
------------------	-------------

Temperature range

Working temperature	-20 °C ... +65 °C
Stock temperature	-40 °C ... +125 °C



Output module

Identification	Part number Female insert (F)	Drawing	Dimensions in mm
<p>Output module, current 3-ways-isolating amplifier; galvanically isolated</p> <p>Output signal 4 ... 20 mA</p> <p>Additional output signal ranges on request</p>	<p>20 75 104 2201</p>		
<p>Output module, voltage 3-ways-isolating amplifier; galvanically isolated</p> <p>Output signal 0 ... 10 V</p> <p>Additional output signal ranges on request</p>	<p>20 75 105 2201</p>		

Han
Modular

Features

- Coding of tools possible (e.g. press tools) by means of an alphanumeric identification
- I²C bus EEPROM as memory medium
- Communication with PLC via conventional digital I/Os
- Physical connection of PLC by means of well-proven Han® contacts
- Assembly of the ID module to the device by means of a Han® industrial connector

Technical characteristics

Inserts

Supply voltage	24 V via digital I/O device Han E® module (see page 06.30)
Electrical connector, 24 V	
Memory capacity	max. 128 Byte
Material	polycarbonate
Working temperature	0 °C ... +70 °C
Stock temperature	0 °C ... +85 °C
Max. length recommended between I/O device and ID module	100 m *

Han
Modular

General description

The HARTING connector identification module (ID module) is suitable for storing of data and for coding of connectors. It is integrated in a Han-Modular® standard E module.

The module can be connected to a 24 V digital I/O device of a PLC. Two digital inputs are used for detecting the module connection and the data input. Two digital outputs are used for the data output and the system clock. Furthermore the ID module must be connected with 24 V and GND. Communication is carried out with voltage levels of 24 V according to the I²C bus standard. The total memory capacity is 128 Byte, e.g. for storing part numbers to identify the module. It is also possible to store the start parameters or operating data for machine components.

A typical data structure is displayed in the following table:

Byte no.

16	15	14	13	12	11	10	9	8	7	6	5	4	3	2	1
Check sum		Operating hours of tool				Start parameter of the unit				Part number of the unit					

Applications for the ID module can be found in modular machines and product lines. A great advantage of the ID module is the non volatile decentralized storing of e.g. operating data. When changing the location stored data can protect the machines from damages. In service cases of the equipment data can be analyzed to minimize service time.



Input module

Identification	Part number Male insert (M)	Drawing	Dimensions in mm
Electronic identification module	20 70 001 1001		





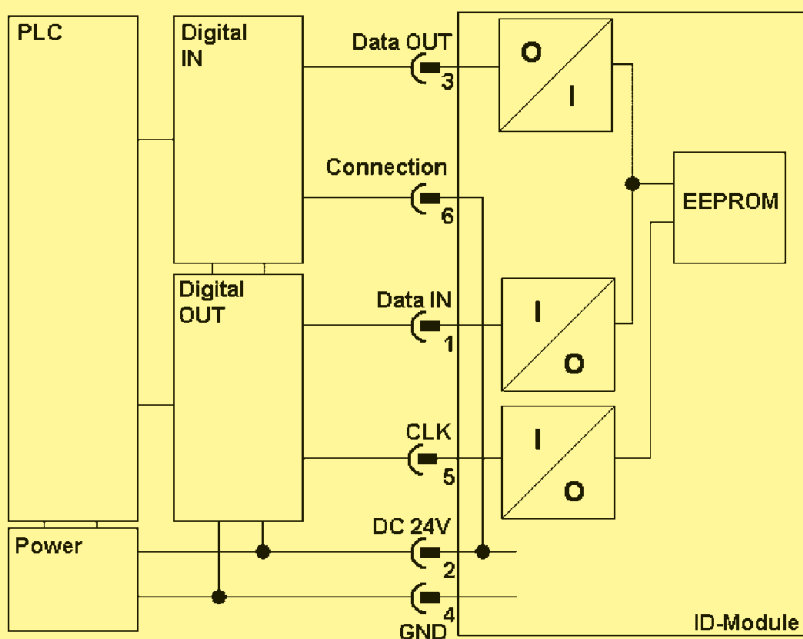

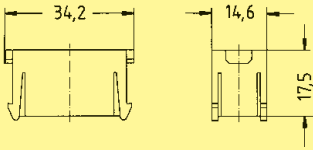

Han
Modular

Block diagram / Wiring plan

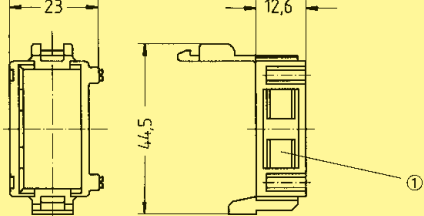

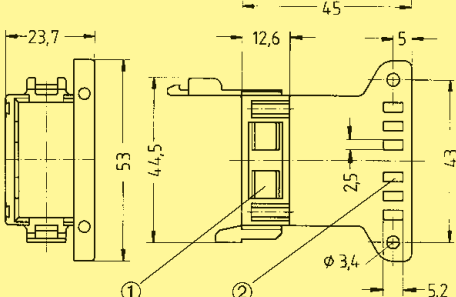
Meaning of the connections

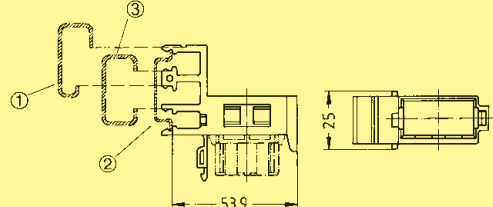
Pin no.	Name	Meaning/Function
1	Data IN	Input for data and control signals from PLC
2	DC 24 V	Power connection of the ID module
3	Data OUT	Output for data signals from ID module to PLC
4	GND	Ground
5	CLK	System clock for synchronisation
6	Connection	Output of the ID module for connection detection

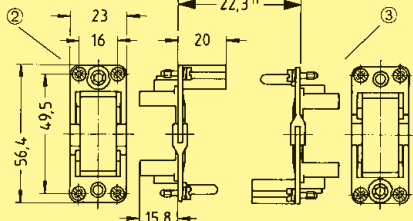
Identification	Part number	Drawing	Dimensions in mm
<p>Han-Modular® Dummy module to fill up module spaces not in use in the frame</p> 	<p>09 14 000 9950</p>		
<p>Module clamp without strain relief *</p>  <p>Delivery comprises 2 module clamps.</p>	<p>09 14 000 0301</p>	 <p>1 Slot for identification strip</p>	
<p>Module clamp with strain relief *</p>  <p>Delivery comprises 2 module clamps.</p>	<p>09 14 000 0302</p>	 <p>1 Slot for identification strip 2 For cable ties with max. 5 mm width</p>	
<p>Module clamp for rail *</p>  <p>Delivery comprises 2 module clamps.</p>	<p>09 14 000 0303</p>	 <p>1 G-rail DIN EN 60 715 2 rail DIN EN 60 715-35 x 7.5 with 1 mm thickness or -35 x 15 with 1.5 mm thickness 3 C-rail DIN EN 60 715-C30</p>	
<p>Frame for 1 module</p>  <p>in housing Han® 10 A</p>	<p>09 14 000 0304</p>	 <p>1 Distance for electrical and F.O. contacts max. 24 mm; for pneumatic contacts max. 23.5 mm 2 Hoods 3 Housings</p>	