

## Flow Switches

- ▶ Piston
- ▶ Shuttle
- ▶ Paddle

### Unique Designs . . . For Use in Liquids or Gases

GEMS' line of flow switches features a broad range of configurations for use in liquids or gases. At preset rates, ranging from 50 cc/min. to 100 GPM, GEMS switches will initiate alarm actuation or automatic shut-down of a system.

These switches feature high quality, corrosion-resistant materials for use in the toughest environments. Material choices, ranging from stainless steel to Ryton®, offer vast chemical compatibility. Versions include switches with fixed or adjustable actuation settings, models for viscosity compensation or high pressures, in-line models and designs to satisfy any mounting or space requirement.

### Variety of Operating Principles

The versatile GEMS Flow Switch line utilizes four basic operating principles. This catalog is organized into four operational types: Piston, Shuttle, Paddle and Electronic. The Shuttle models are for use with high flow rates; the Piston types are designed for low flow rates; the Paddle for large line sizes and the Electronic switches encompass state-of-the-art electronics and positive visual indication.

### Flow Rate Selection Guide

Set Point		Switch Series	Body Materials
Water	Air		
50 cc to 300 cc/min.	2 to 50 SCFH	FS-926	Alloys
0.1 to 1.0 GPM (oil)	—	FS-930	
0.1 to 1.5 GPM	—	FS-4	Engineered Plastics
0.1 to 1.5 GPM	0.5 to 25.0 SCFM	FS-925	Alloys
0.1 to 1.5 GPM	—	FS-927	
0.15 to 2.0 GPM	—	FS-380	
0.25 to 2.0 GPM	—	FS-380P	
0.1 to 60 GPM	—	RFS-2500 Rotorflow <sup>1</sup>	Eng. Plastics & Alloys
0.5 to 3.0 GPM	—	FS-480	Alloys
0.5 to 5.0 GPM	—	FS-150	Engineered Plastics
0.5 or 2 GPM	—	FS-400P	
0.25 to 5.0 GPM	—	FS-500	
0.5 to 20.0 GPM	1.0 to 160.0 SCFM	FS-10798	Alloys
0.5 to 100 GPM	—	FS-200	
0.75 to 10.0 GPM	—	FS-400	
0.75 to 14.0 GPM	—	FS-400 Adjustable	
1.0 to 15.0 GPM	—	FS-200 Adjustable	
Dependent on Pipe Size and Paddle Length	—	FS-550 Series	

Note:  
1. See Section E.

Contents	Page Start
Piston Type.....	G-2
Shuttle Type.....	G-16
Paddle Type .....	G-23

Piston Types



Shuttle Types

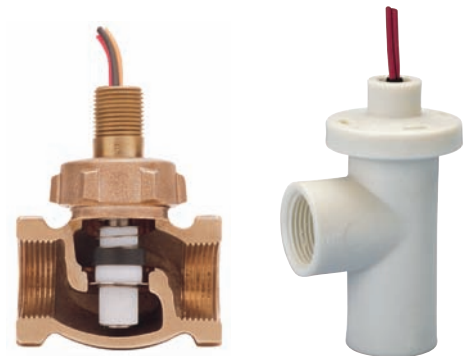

Paddle Types



## Piston Type Switches – For Low Flow Rates in Liquids and Gases

- ▶ Models for liquid flow rates as low as 50 cc/min. and gas flow rates as low as 2 SCFH
- ▶ Small, compact housings with port sizes from 1/4" NPT
- ▶ Precision built for superior accuracy

### Typical Applications

Protect your expensive electronic equipment from coolant flow failure on...

- Laser Heads • Welders • Power Supplies • High Speed Spindles • X-Ray Tubes
- Semiconductor Equipment

Assure proper lubrication flow to critical bearings or gears to prevent system downtime on...

- Presses • Rotating Equipment • Conveyors • Machine Tools • Robotics

Ensure system integrity in processing and dispensing equipment on...

- Water Purifications and Filtering • X-Ray film Processing
- Beverage dispensing • Chemical additives • Gas sampling • Distilling

### Design Data

#### General Operating Principles

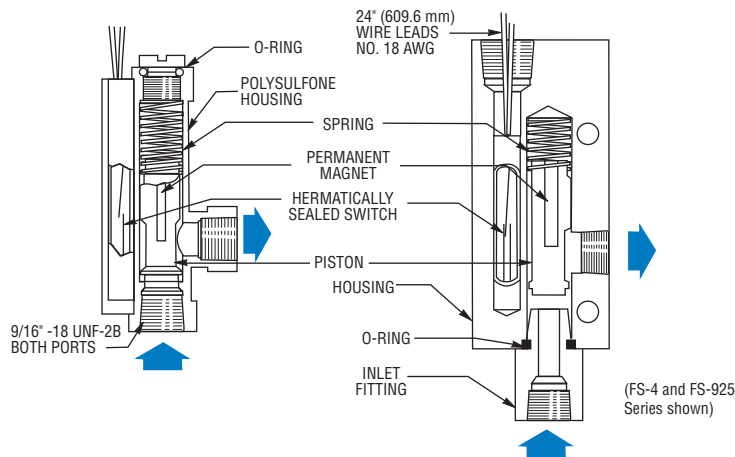

#### Low-Flow Switches

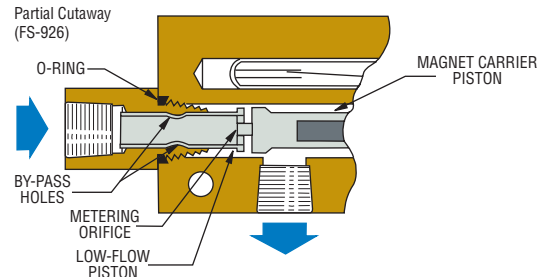

An additional, lap-fitting piston is used in GEMS FS-926 Series to accurately detect low-flow rates. Calibration is determined by one or more metering holes in the top of the low-flow piston, which regulates bypass flow, and therefore the actuation setting. When metered bypass flow is exceeded, the resultant pressure differential displaces the low-flow piston, moving the magnet carrier piston to actuate the reed switch. Two large bypass holes in the piston skirt are exposed after actuation to maintain low pressure drop.

#### Externally Adjustable Switches

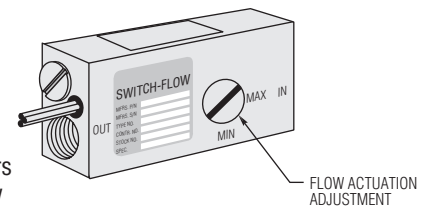

The FS-10798 Series offers infinite flow settings from 0.5 to 20 GPM. Versions suitable for gas flow monitoring are also available.

A piston, encapsulating a permanent magnet, is positioned in the flow path within the unit housing. When displaced by the pressure differential from fluid flow, this piston magnetically actuates a hermetically sealed reed switch (SPST or SPDT, depending on the series) within the unit. The piston metering land diameter precisely sets the actuation point by regulating bypass clearance. A stainless steel spring provides positive piston return as flow decreases. The reed switch, when actuated, can be used to operate remote alarms or indicators. Or, it may be integrated into automatic system controls.

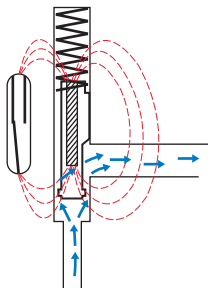

### Viscosity Compensating Switches

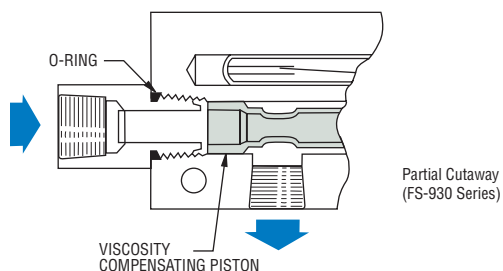

When temperatures of viscous fluids change, so do their flow properties. With viscosity lowered by increasing temperature, a greater flow is generally required to create actuation pressure differential. A unique patented piston within GEMS FS-930 Series switches accommodates these changes in fluid viscosity while maintaining accurate switch actuation. Units can detect flow rates with 20% accuracy for liquid viscosities between 40 to 1000 SSU.

### Low Pressure Drop Switches

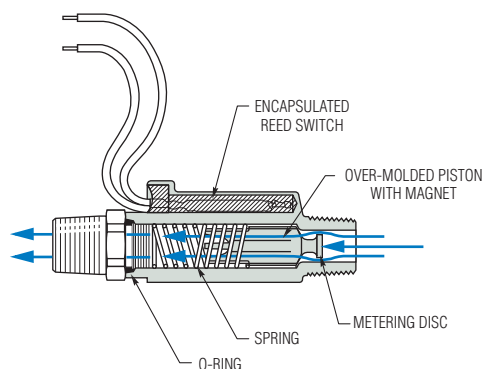

The key to the excellent flow qualities of the FS-150 and FS-380 Series switches is the dual diameter internal bore. At flow rates below the actuation point, the fluid passes around the piston and metering disc within the “metering bore.” As fluid flow increases past the actuation point, the metering disc enters the “flow bypass bore” where the increased diameter provides generous flow paths. The result is a low pressure drop for high flow rates and less susceptibility to fouling.

### Typical Piston and Spring Removal

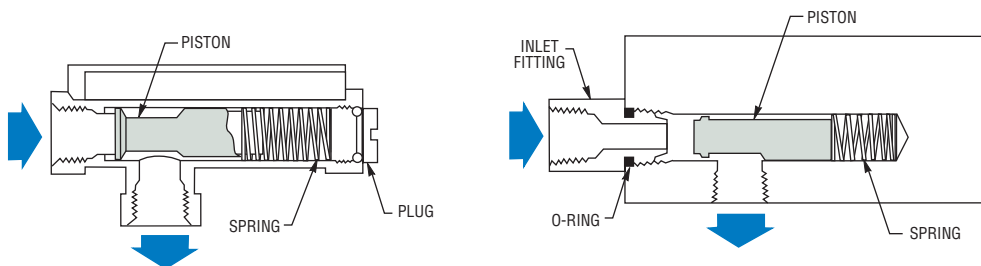

Accumulation of foreign debris should periodically be removed from these switches. GEMS' designs provide for easy piston and spring removal for this occasional cleaning. Recommended cleaning procedures are provided in the Instruction Bulletin shipped with each unit. 150 micron filtration is recommended for the FS-150 Series; 100 micron for FS-380, 50 micron filtration is recommended for all other piston type switches.

NOTE: All air/gas Flow Switches are factory calibrated using a special piston. Water calibrated units are not recommended for air/gas applications.

Contents	Page Start
FS-4 Series	
Molded Plastic Construction.....	G-4
FS-150 Series	
Straight-Through Flow Path, Ryton Material.....	G-5
FS-380 Series	
High Pressure Inline .....	G-6
FS-380P Series	
Inline – Plastic Flow .....	G-7
FS-480 Series	
Low Pressure Drop.....	G-8
FS-927 Series	
Miniature Brass Switches .....	G-9
FS-925 Series	
General Purpose.....	G-10
FS-926 Series	
Low Flow .....	G-10
FS-10798 Series	
Externally Adjustable .....	G-12
FS-930 Series	
Viscosity Compensating.....	G-14

# FS-4 Series – Low Cost, Molded Plastic Construction

**Flow Rate Settings:** 0.1 GPM to 1.5 GPM

**Port Size:** 9/16"-18 UNF

**Primary Construction Material:** Ryton®

**Setting Type:** Fixed

The FS-4 Series makes flow protection economical for a broad range of industrial applications such as welders, lubrication systems, medical sterilizers and laundry chemicals dispensing.

## Specifications

<b>Wetted Materials</b>	
Housing and Piston	Ryton® R4
Spring	316 Stainless Steel
O-Ring	Viton®
<b>Other Wetted Parts</b>	
Epoxy	
<b>Operating Pressure, Maximum</b>	250 PSIG (17.2 bar) @ 70°F (21°C)
<b>Operating Temperature</b>	0°F to 225°F (-17°C to +107°C)
<b>Set Point Accuracy</b>	±15% Maximum
<b>Set Point Differential</b>	20% Maximum
<b>Switch*</b>	SPST or SPDT, 20 VA (SPDT: 240 VAC Max.)
<b>Inlet/Outlet Ports</b>	9/16" -18 UNF-2B Thread
<b>Recommended Filtration</b>	50 Microns or Better
<b>Electrical Termination</b>	
SPST	18 AWG, Zipcord, 24" Long
SPDT	18 AWG, PVC 24" Long Leads

\* See "Electrical Data" on Page X-5 for more information.

## How To Order – Standard Models

Housing and Piston Material	Flow Setting GPM	Part Numbers		
		SPST Switch		With SPDT Switch
		N.O., No Flow	N.C., No Flow	
Ryton®	0.1	122340	122346	122352
	0.25	122341	122347	122353
	0.5	122342	122348	122354
	0.75	122343	122349	122355
	1.0	122344	122350	122356
	1.5	122345	122351	122357

Note:  
Flow settings are calibrated using water @ +70°F on increasing flow, with units in a vertical position (lead wires up).

## Port Adapters for FS-4

Converts 9/16" threaded ports to NPT or barbed connection. Made of Ryton®-R4 or polypropylene with O-Rings in place.

**CAUTION:** Do not exceed 15 in./lbs. maximum torque when installing adapter fittings.

Material	Adapter Size	Part Numbers
Ryton®	1/8" NPT*	123028
	1/4" NPT*	123029
Polypropylene	1/4" NPT*	158602
	1/2" Barb**	158603

\*Wrench flats provide for proper assembly.  
\*\* Accepts 1/2" I.D. flexible hose  
– Stock Items.



U.L. Recognized —  
File No. E31926  
CSA Listed —  
File No. LR30200

## Dimensions

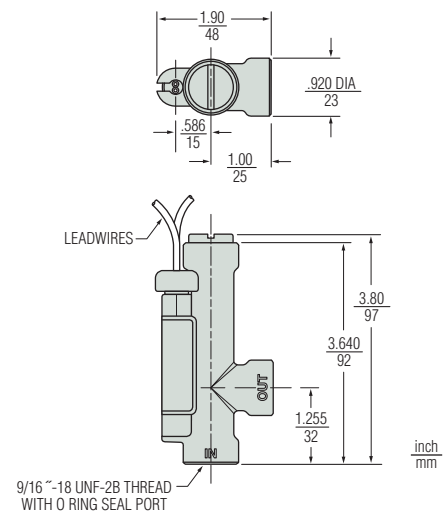

## Pressure Drop – Typical

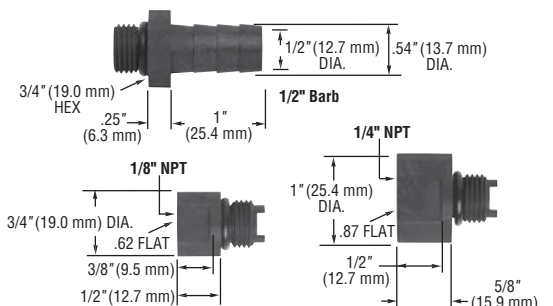
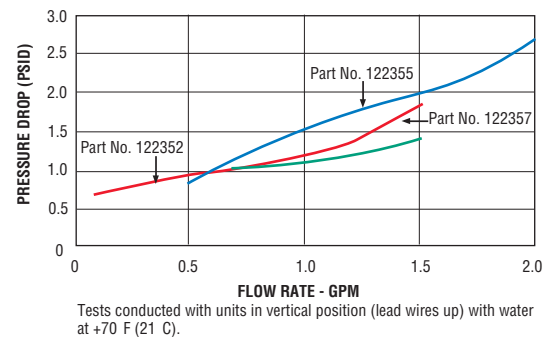

# FS-150 Series – Straight Flow Path with Low Pressure Drop

**Flow Rate Settings:** Liquids: 0.5 GPM to 5 GPM  
**Port Size:** 1/2" NPT  
**Primary Construction Material:** Polypropylene  
**Setting Type:** Fixed

These slim, inline switches reduce pressure drop to a minimum. They incorporate a unique, dual-diameter, internal bore and piston configuration to minimize flow constriction. Liquids are able to smoothly pass around the piston and flow through the switch with little pressure loss to the down stream line.

## Specifications

<b>Wetted Materials</b>	
<b>Housing</b>	Polypropylene, Hydrolytically Stable, Glass Reinforced
<b>Piston</b>	Ryton® -R4, 316 Stainless Steel
<b>O-Ring</b>	Viton®
<b>Spring</b>	316 Stainless Steel
<b>Operating Pressure, Maximum</b>	200 PSIG (13.8 bar) @+70°F to +150°F (+21.1°C to 65.5°C) 150 PSIG (10.3 bar) @+150°F to +212°F (+65.5°C to +100°C)
<b>Operating Temperature</b>	0°F to 212°F (-17.8°C to +100°C)
<b>Set Point Accuracy</b>	±15%
<b>Set Point Differential</b>	20% Maximum
<b>Switch*</b>	SPST, 20 VA
<b>Inlet/Outlet Ports</b>	1/2" NPT Male
<b>Electrical Termination</b>	1/4" Male Quick Connect Terminals (2)

\*See "Electrical Data" on Page X-5 for more information.

## How To Order – Standard Models

Specify Part Number based on flow setting and switch operation.

Flow Settings GPM	Part Numbers	
	Normally Open @ No Flow	Normally Closed @ No Flow
0.5	129660 ⚡	129666
1.0	129661 ⚡	129667
2.0	129662 ⚡	129668
3.0	129663 ⚡	129669
4.0	129664	129670
5.0	129665	129671

Notes:

- Flow settings are calibrated using water @ +70°F on increasing flow, with units in a horizontal position (terminals up).
- Care should be taken by specifiers to ensure fluid compatibility with the above listed wetted materials.
- Use of 150 micron filtration is recommended.

⚡ – Stock Items.

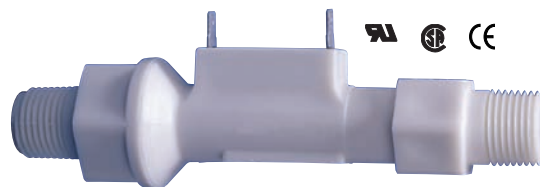

U.L. RECOGNIZED —  
 FILE NO. E31926  
 CSA Listed —  
 File No. LR30200

Patent #  
 4.996.396

## Dimensions

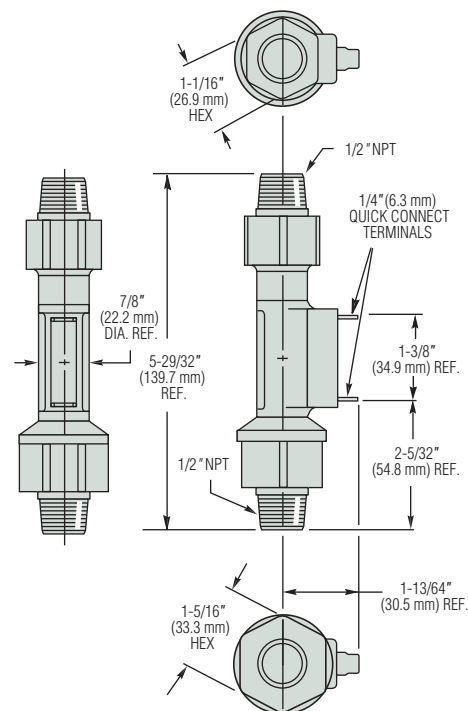

Note: Cable output available. Please consult factory.

## Pressure Drop - Typical

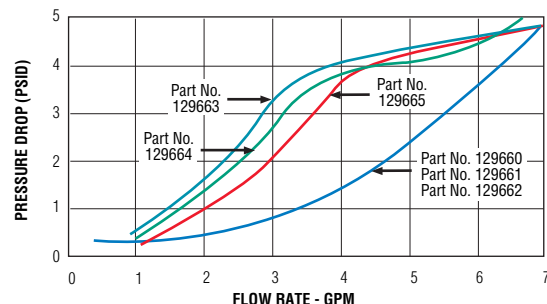

Tests conducted with units in a horizontal position with water at +70°F (21°C). Data will vary slightly for vertically mounted units.



# FS-380 Series – Compact Flow Switch for High Inline Pressures

**Flow Rate Settings:** 0.15 GPM to 2.00 GPM  
**Port Size:** 3/8" NPT Male  
**Primary Construction Material:** Brass or Stainless Steel  
**Setting Type:** Fixed

These rugged inline flow switches use 100 micron filtration and are less susceptible to clogging than other high-pressure inline flow switches. The one-piece magnetic PPS composite piston makes the FS-380 ideal for high-pressure applications such as industrial cleaning equipment. The FS-380 is also an excellent choice for semicon cooling applications where simple design and reliable operation are required.

## Specifications

<b>Wetted Materials</b>	
<b>Housing</b>	Brass or 316 Stainless Steel
<b>Piston</b>	PPS Composite, Epoxy
<b>Spring</b>	316 Stainless Steel
<b>O-Ring</b>	Fluorocarbon
<b>Operating Pressure, Maximum</b>	1500 PSI (107 bar)
<b>Operating Temperature</b>	-20°F to +275°F (-28.8°C to +135°C)
<b>Set Point Accuracy</b>	±20% Maximum
<b>Set Point Differential</b>	20% Maximum
<b>Switch*</b>	SPST, 20VA, N.O. at no Flow
<b>Electrical Termination</b>	No. 22 AWG, 24" to 26" Polymeric leads

\* See "Electrical Data" on Page X-5 for more information.

## Spacing

To prevent sensor to sensor magnetic field interference, follow the spacing guidelines below.

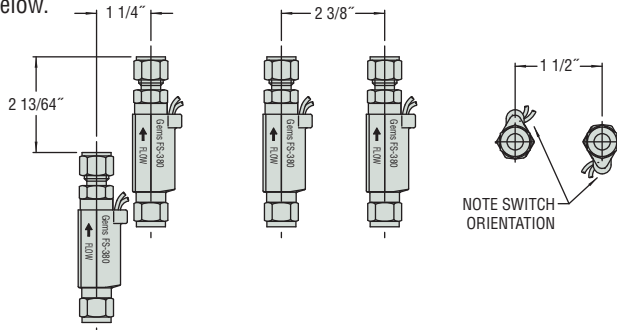

## How To Order – Standard Models

Specify Part Number based on flow settings.

Flow Settings GPM <sup>1</sup>	3/8" NPT Male		3/8" Tube Compression Fitting	1/2" NPT Male
	Brass	Stainless Steel	Stainless Steel	Brass
0.15	181130	193482	212136	—
0.25	168432 ⚡	179992 ⚡	177592 ⚡	192562
0.50	168433 ⚡	179993 ⚡	177593	192563
1.00	168434 ⚡	179994 ⚡	177594 ⚡	192564
1.50	168435	179995	177595	192566
2.00	178353	179996	225525	192567

⚡ – Stock Items.

Note:  
 1. Flow settings are calibrated using water @ 70°F on increasing flow with units in horizontal position. Consult factory for other fluid compatibility.

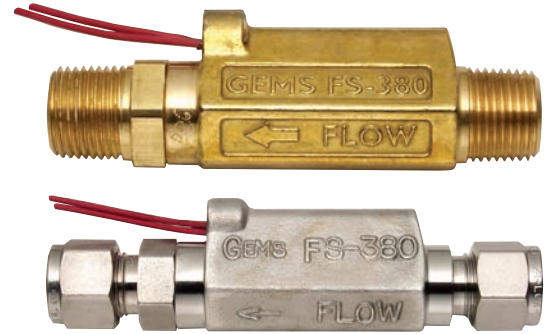

CE cRUUS U.L. Recognized File No. E31926

## Dimensions

### 1/2" NPT Ports

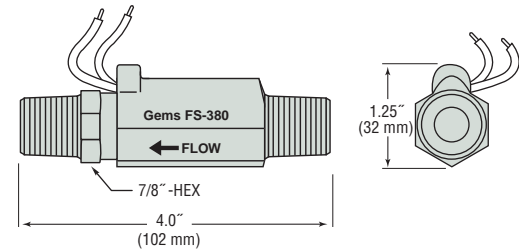

### 3/8" NPT Ports

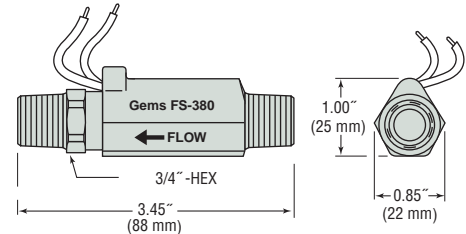

### 3/8" Tube End Compression Fitting

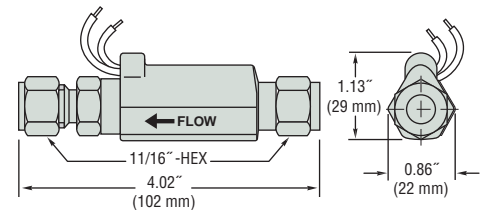

## Pressure Drop – Typical

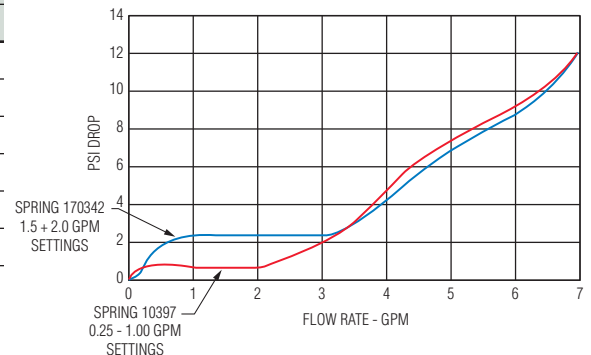

# FS-380P Series – Industrial Strength Inline Plastic Flow Switch

**Flow Rate Settings:** 0.25 GPM to 2.00 GPM  
**Port Size:** 3/8" NPT Male and 1/4" Quick Disconnect (QDC) Male  
**Primary Construction Material:** Polypropylene  
**Setting Type:** Fixed

This rugged inline flow switch offers the same superior performance to non-clogging as its metal cousin (FS-380). The fixed set point and simple design make it a dependable switch. The FS-380P is an ideal choice for coolant applications requiring reliable flow detection in HVAC, semiconductor, welding, medical and other industries. 1/4" quick disconnect units have a host of snap-on mating adapters to fit most piping requirements.

## Specifications

<b>Wetted Materials</b>	
<b>Housing</b>	Glass Reinforced Polypropylene
<b>Piston</b>	PPS Composite
<b>Spring</b>	316 Stainless Steel
<b>O-Ring</b>	Fluorocarbon
<b>Operating Pressure</b>	125 PSI (8.6 bar) @ 70°F (21°C), 50 PSI (3.4 bar) @ 212°F (100°C)
<b>Operating Temperature</b>	0°F to 212°F (-18°C to +100°C)
<b>Set Point Accuracy</b>	20% of Set Point
<b>Set Point Differential</b>	20% Maximum
<b>Switch*</b>	SPST, 10VA, N.O. at no Flow
<b>Electrical Termination</b>	24" to 26" Polymeric Leads, 22 AWG
<b>Filtration</b>	100 Micron
<b>Approvals</b>	CUL

\*See "Electrical Data" on Page X-5 for more information.

## How To Order

Specify Part Number based on flow settings. Adapters for the 1/4" Quick Disconnect (QDC) Male unit are listed in the table at right.

Flow Settings GPM	Part Numbers	
	3/8" NPT Male	1/4" QDC Male*
0.07	216445**	216446**
0.15	209876	203206
0.25	197081 ⚡	197091 ⚡
0.50	197082 ⚡	197092 ⚡
1.00	197083 ⚡	197093 ⚡
1.50	197084 ⚡	197094 ⚡
2.00	197085 ⚡	197095 ⚡

\* See selection of adapters at right.  
 QDC = Quick Disconnect  
 \*\* Set point accuracy 0.06 to 0.1 GPM

⚡ – Stock Items.

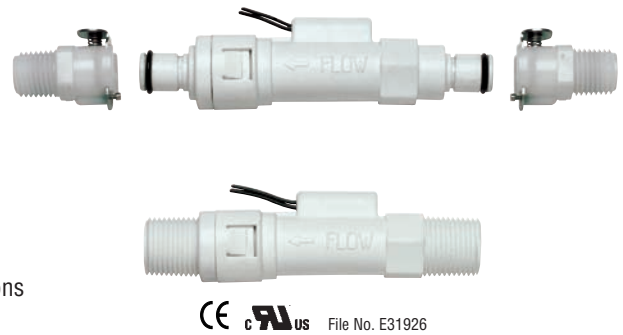

CE cRUUS File No. E31926

## Dimensions

**1/4" Quick Disconnect Male Adapter**  
 See table at bottom right for adapter Part Numbers.

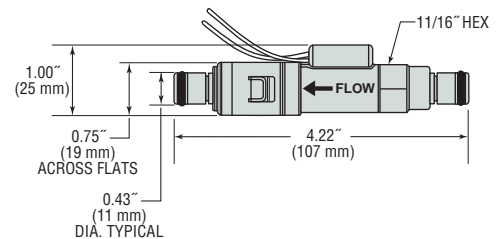

**3/8" NPT Port**

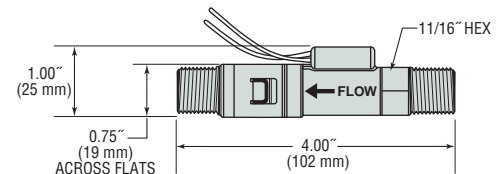

Acetal Adapters for 1/4" Quick Disconnect Male Tube Fitting Units (180°F max.)

These adapters are available with or without an integral shut-off valve. The shut-off valve will stop line flow when the adapter is removed from the unit. Flow resumes when connected.



Typical shown: 1/4" NPT Male Pipe Thread with Shut-off Valve

Description	Part Numbers	
	Straight Through	with Shut-Off Valve
1/4" NPT Male Pipe Thread	195787 ⚡	198063
1/4" BSPT Male Pipe Thread	198064 ⚡	195788
3/8" NPT Male Pipe Thread	198065 ⚡	198066
3/8" BSPT Male Pipe Thread	198067 ⚡	198068
1/4" O.D., .27" I.D. (6 mm O.D., 4.3 mm I.D.) Polytube	198096 ⚡	198097
3/8" O.D., 1/4" I.D. (9.5 mm O.D., 6 mm I.D.) Polytube	198099 ⚡	198098
1/4" (6.4 mm) I.D. Barb	198401 ⚡	198402
5/16" (7.9 mm) I.D. Barb	198403 ⚡	198404
3/8" (9.5 mm) I.D. Barb	198408 ⚡	198405
1/4" O.D. (6.4 mm) O.D. JG®	198470 ⚡	198406
3/8" O.D. (9.5 mm) O.D. JG®	198459 ⚡	198407

JG® is a registered trademark of John Guest USA, Inc.

# FS-480 Series – Stainless Steel Flow Switch for Large Flow, Low Pressure Drop

**Flow Rate Settings:** 0.50 GPM to 3.00 GPM  
**Port Size:** 1/2" NPT, 3/4" NPT, 1/2" Tube Compression Fitting  
**Primary Construction Material:** 316 Stainless Steel  
**Setting Type:** Fixed

The FS-480 large-body inline flow switch delivers ample flow rates with minimal pressure drop. 25% larger than its FS-380 sibling, the FS-480 is ideal for processes that push more fluid through their systems and demand low pressure drops. Designed to accommodate the Semiconductor Industry's move to larger 300 mm wafer and cross-over equipment, this switch is also perfect for critical medical equipment applications. A glass-reinforced PPS piston and forged 316 stainless steel body make this sensor rugged enough for high pressure lubrication and cooling systems as well. This simple, yet meticulously perfected design provides the reliability required in critical applications while allowing for much lower pressure drop rates than other available switches.

## Specifications

<b>Wetted Materials</b>	
Housing/End Fitting	316 Stainless Steel
Piston	PPS, Epoxy
Spring	316 Stainless Steel
O-Ring	Fluorocarbon
<b>Operating Pressure, Maximum</b>	1000 PSI (69 bar)
<b>Operating Temperature</b>	-20°F to +250°F (-28.8°C to +121°C)
<b>Set Point Accuracy</b>	±20% Maximum
<b>Set Point Differential</b>	20% Maximum
<b>Recommended Filtration</b>	100 Micron or better
<b>Switch*</b>	SPST, 20VA, 120/240 VAC, N.O. at no Flow
<b>Electrical Termination</b>	No. 22 AWG, 24" PVC Cable

\*See "Electrical Data" on Page X-5 for more information.

## Pressure Drop – Typical 1.0 GPM Set Point

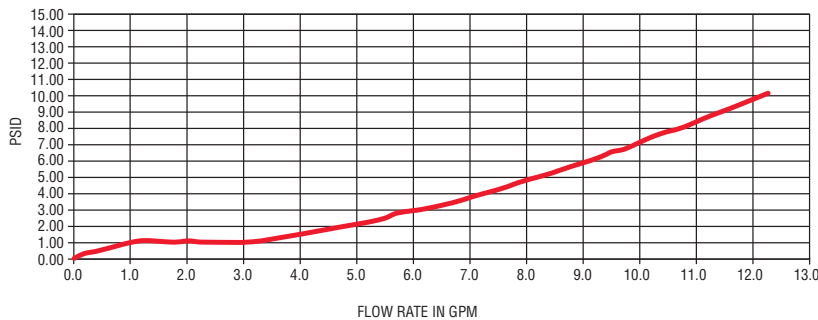

## How To Order – Standard Models

Specify Part Number based on flow settings.

Flow Settings* GPM	1/2" NPT Port	3/4" NPT Port	1/2" Tube Compression Fitting
0.50	206915	204715	204710
1.00	206916	204716	204711
1.50	206917	204717	204712
2.00	206918	204718	204713
3.00	206919	204719	204714

\*Calibrated with unit in horizontal position.

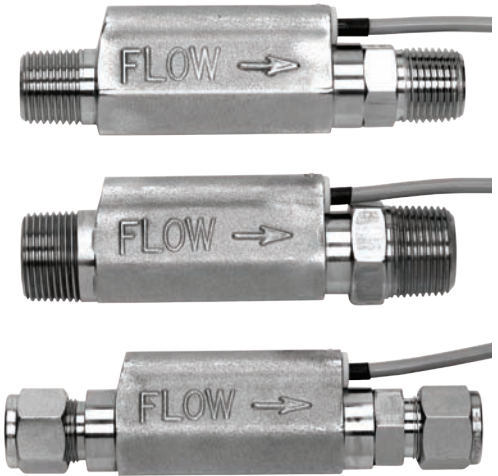

**RU** us File No. E31926

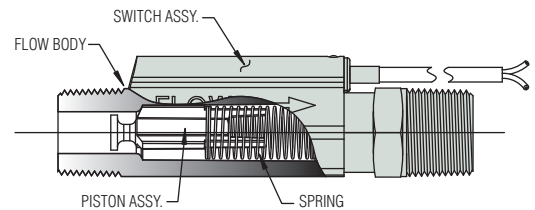

Straight design and large bore body minimizes pressure drop.

## Dimensions

### 1/2" NPT Ports

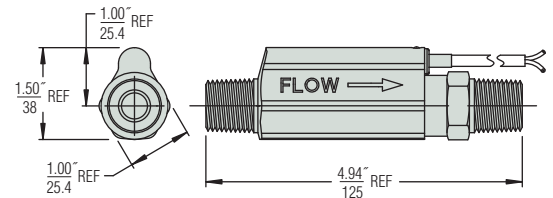

### 3/4" NPT Ports

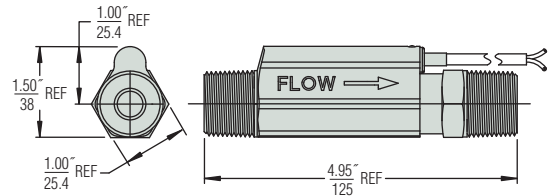

### 1/2" Tube End Compression Fitting

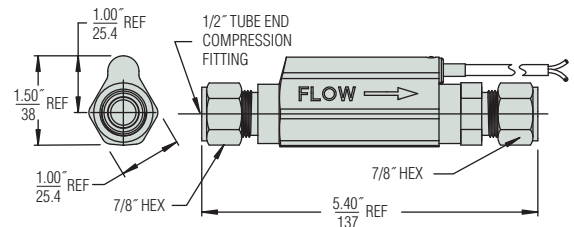

FLOW SWITCHES



# FS-927 Series – Small Design for Tight Instrumentation Packages

**Flow Rate Settings:** 0.10 GPM to 1.50 GPM  
**Port Size:** 1/4" NPT  
**Primary Construction Material:** Brass, Stainless Steel  
**Setting Type:** Fixed

Measuring only 1" x 2-3/4", these compact switches are ideal for use where space is at a premium. Designed for use with water and oil, these switches are suitable for high volume OEM applications. They are ideal for coolant or lubricant flow monitoring in portable equipment and many other applications with space constraints.

## Specifications

<b>Wetted Materials</b>	
Housing and Piston	Brass, Stainless Steel
Spring	316 Stainless Steel
<b>Other Wetted Parts</b>	
	Stainless Steel
<b>Operating Pressure, Maximum</b>	1000 PSIG (69 bar)
<b>Operating Temperature</b>	-20°F to +200°F (-29°C to +93.3°C)
<b>Set Point Accuracy</b>	±15%
<b>Set Point Differential</b>	20% Maximum
<b>Switch*</b>	SPST, 20 VA
<b>Inlet/Outlet Ports</b>	1/4" NPT
<b>Electrical Termination</b>	No. 18 AWG, 24" L., PVC Lead Wires

\*See "Electrical Data" on Page X-5 for more information.

## How To Order – Standard Models

Specify Part Number based on flow setting and switch operation.

**Liquids other than water:** Special calibration is available from Gems for media other than water. Please consult factory with your requirements, including flow media, operating pressure, flow set point and liquid viscosity (SSU).

Flow Settings GPM	Part Numbers		
	Brass		Stainless Steel
	Normally Open @ No Flow	Normally Closed @ No Flow	Normally Open
0.10	70820 ⚡	70826	26969
0.25	70821 ⚡	70827	26970
0.50	70822 ⚡	70828	26971
0.75	70823 ⚡	70829	26972
1.00	70824 ⚡	70830	26973
1.50	70825	70831	26974

Notes:

- Flow settings are calibrated using water @ +70°F on increasing flow, with units in a vertical position (lead wires up).
- Care should be taken by specifiers to ensure fluid compatibility with the above listed wetted materials.
- Use of 50 micron filtration is recommended.

⚡ – Stock Items.

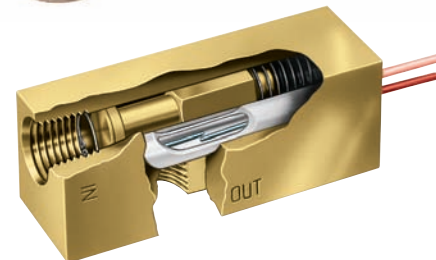
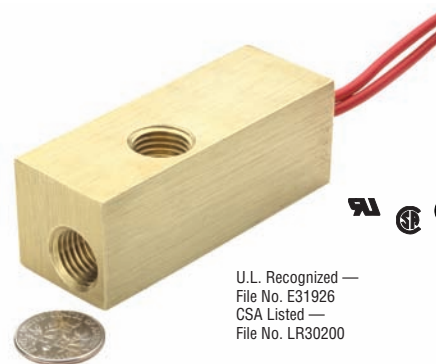

## Dimensions

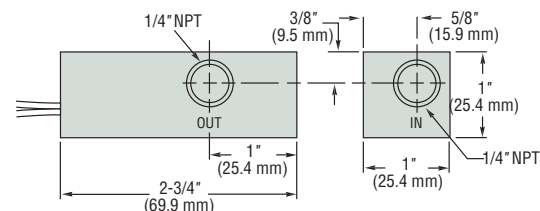

## Pressure Drop – Typical

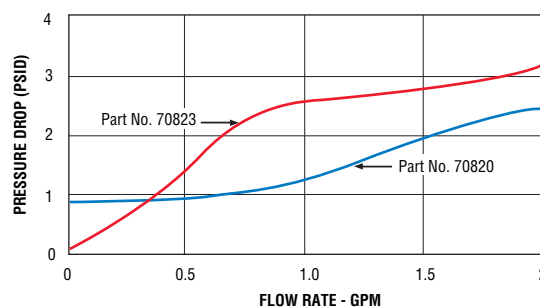

FLOW SWITCHES

## FS-925 Series – General Purpose

**Flow Rate Settings:** Liquids: 0.1 GPM to 1.5 GPM  
Air/Gases: See Flow Settings at right

## FS-926 Series – Low Flow

**Port Size:** 1/4" NPT  
**Primary Construction Material:** Brass or Stainless Steel  
**Setting Type:** Fixed  
**Flow Rate Settings:** Liquids: 50-300 cc/min.  
Air/Gases: See Flow Settings at right

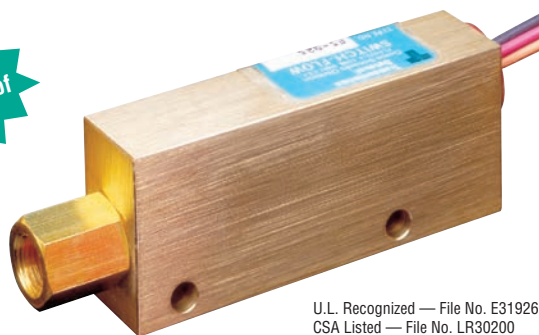

FS-925/926 Series



U.L. Recognized — File No. E31926  
CSA Listed — File No. LR30200  
FM Approved — File No. 1H3A2.AX  
and 0A8A3AE

These two series of precision-calibrated switches provides reliable and consistent performance; repeatability is within 1%. FS-925 and FS-926 units are factory preset for actuation at specified flow rates.

These switches provide accurate detection of excessive or insufficient flow rates in such applications as: protecting against loss of fluid flow in hydraulic systems, assuring proper coolant flow in semiconductor processing equipment, monitoring high pressure lubrication systems, and ensuring proper air flow in water/waste systems.

### Specifications

<b>Wetted Materials</b>	
<b>Housing</b>	Brass or 316 Stainless Steel
<b>Piston</b>	
<b>In Brass Housing</b>	Polysulfone for water; Brass for oil or air
<b>Stainless Steel Housing</b>	316 Stainless Steel
<b>Low Flow Piston (FS-926)</b>	Same as Housing
<b>Spring</b>	316 Stainless Steel
<b>O-Ring</b>	Viton®
<b>Other Wetted Parts</b>	Epoxy
<b>Pressure Rating</b>	
<b>Operating, Maximum</b>	1000 PSIG (69 bar)
<b>Proof</b>	2500 PSIG (172 bar)
<b>Burst</b>	5000 PSIG (345 bar)
<b>Operating Temperature</b>	
<b>With Brass or S.S. Piston</b>	-20°F to +300°F (-29°C to +148.9°C)
<b>With Polysulfone Piston</b>	-20°F to +225°F (-29°C to +107.2°C)
<b>Repeatability</b>	1% Maximum Deviation
<b>Set Point Accuracy</b>	±10%
<b>Set Point Differential</b>	15% Maximum
<b>Switch*</b>	SPDT, 20 VA
<b>Inlet/Outlet Ports</b>	1/4" NPT
<b>Electrical Termination</b>	No. 18 AWG, 24" L., Polymeric Lead Wires

\*See "Electrical Data" on Page X-5 for more information.

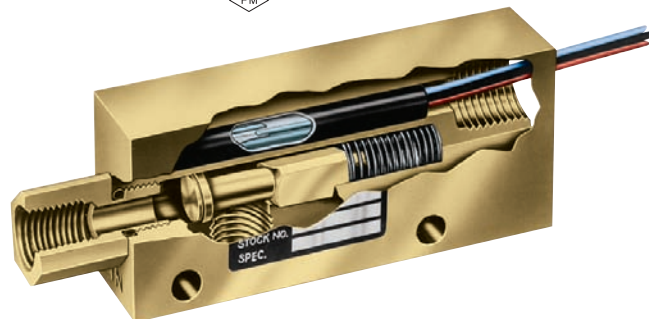

Both the FS-925 and FS-926 use a spring-loaded piston to detect positive flow with great precision. They act upon direct fluid flow and will not show "false-positive" flow indication as can happen with sensors using indirect sensing methods such as pressure measurement. The FS-926 incorporates an additional lap-fitted piston for very low flows; see below.

### Dimensions

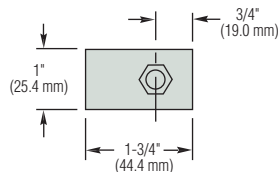
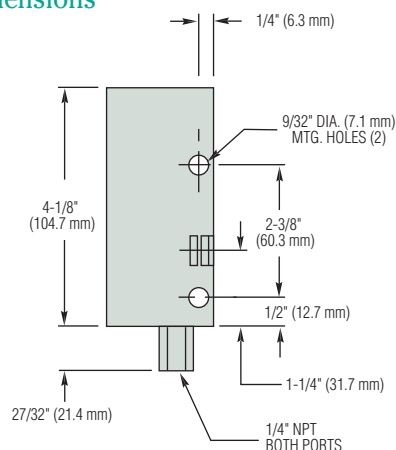

### Electrical Connection, 1/2" NPT Conduit

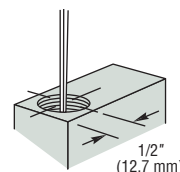

### Double Piston Detects Minute Flow – FS-926

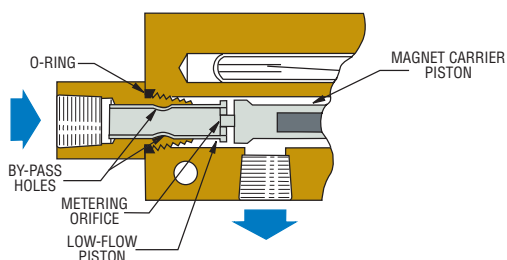

An additional, lap-fitted piston is used in Gems FS-926 Series to accurately detect low-flow rates. Calibration is determined by one or more metering holes in the end of the low-flow piston, which regulate bypass flow, and therefore the actuation setting.

When metered bypass flow is exceeded, the resultant pressure differential displaces the low-flow piston, moving the magnet carrier piston to actuate the reed switch. Two large bypass holes in the piston skirt are exposed after actuation to maintain low pressure drop.

### Flow Settings, Air (Typical)

Dependent on operating line pressure. Examples of set point ranges at a given line pressure are shown below.

Line Pressure	Actuation Point			
	FS-925		FS-926	
	Min.	Max.	Min.	Max.
5 PSIG (Minimum)	0.5 SCFM	10 SCFM	2 SCFH	15 SCFH
100 PSIG	1.5 SCFM	25 SCFM	7 SCFH	50 SCFH

Minimum 5 PSI line pressure required.

### Gas Calibration

Water flow units should not be used for air/gas applications: Gas flow units have a special dash-pot piston for reliable operation. Gas calibration is dependent upon line pressure, switch orientation, and the specific type of gas. The calibrated flow set point is subject to change with fluctuations in line pressure.

### How To Order – Standard Models – Water Calibration

Specify Part Number based on desired housing material and flow setting.

**Liquids other than water:** Special calibration is available from GEMS for media other than water. Please consult factory with your requirements, including housing material (brass or stainless steel), flow media, operating pressure, flow set point and liquid viscosity (SSU). A lot charge will be applied for special calibrations.

**Gas flow:** Consult factory for available calibrations. Specify: Housing material (brass or stainless steel), gas type, mounting orientation, operating pressure and actuation setting (SCFM or SCFH) and normal flow rate. A lot charge will be applied for special calibrations.

### FS-925 Series – General Purpose

Flow Settings GPM, ±10%	Part Numbers	
	Brass	316 S.S.
0.10	26914 ⚡	26926 ⚡
0.25	26915 ⚡	26927 ⚡
0.50	26916 ⚡	26928
0.75	26917 ⚡	26929
1.00	26918 ⚡	26930
1.50	26919 ⚡	26931

### FS-926 Series – Low Flow

Flow Setting		Part Numbers	
cc/Min. ±10%	Equiv. GPM	Brass Material	316 S.S. Material
50	.013	26938 ⚡	26951 ⚡
100	.025	26939 ⚡	26952
150	.045	26941 ⚡	26953
200	.055	26942	26954
250	.065	26943	26955
300	.075	26944	26956

Notes:

- Flow settings are calibrated using water @ +70°F on increasing flow, with units in a vertical position (lead wires up). Consult factory regarding special flow setting calibration.
- Temperature changes will slightly affect the standard water or gas flow settings listed. Oil flow settings will vary with viscosity.
- Use of 50 micron filtration is recommended.

⚡ – Stock Items.

### Pressure Drop - Typical

#### FS-925 Series

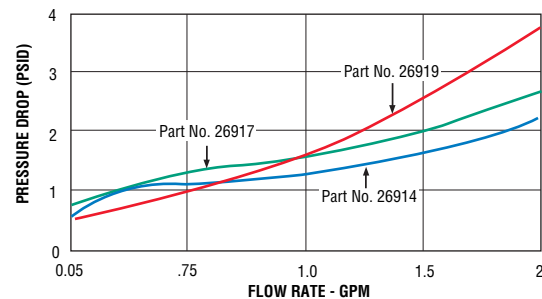

Tests conducted with units in vertical position (lead wires up) with water at +70°F (21°C).

#### FS-926 Series

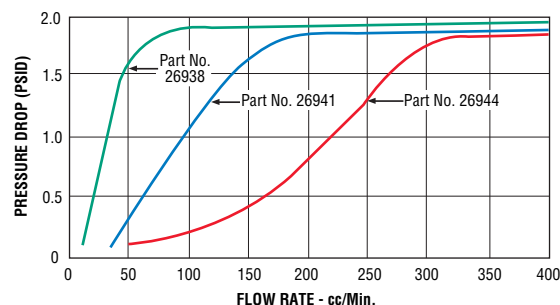

Tests conducted with units in vertical position (lead wires up) with water at +70°F (21°C).

**FS-925 and FS-926 switches are U.L. Approved for Class I, Division 2, Groups A, B, C, D hazardous locations.**

They are also available with FM-approved, explosion-proof junction box for Class I, Division 1, Group D hazardous locations. Units must be assembled completely at GEMS.

U.L. Approved — File No. E183854

### Standard Wiring Color Code

Wire Color	Terminal
Orange	N.O.
Black	Common
Red	N.C.

# FS-10798 Series – Externally Adjustable for Water, Oils and Gases

**Flow Rate Settings:** Liquids: Infinite Adjustment between 0.5 GPM and 20.0 GPM

Air/Gases: See Gas Flow Adjustment Ranges below

**Port Size:** 1/2" NPT

**Primary Construction Material:** Brass or Stainless Steel

**Setting Type:** Adjustable

These externally adjustable switches are ideal for protecting machine tools from coolant flow failure, for protecting bearings from loss of lubricant or to assure proper air flow. They offer an infinite number of flow settings at pressures up to 1000 PSIG, with low pressure drop and precise repeatability.

The adjusting vane is easily field adjustable using an ordinary flat-bladed screwdriver. The adjustment is set-screw-locked for tamper-free operation after field calibration.

## Specifications

Wetted Materials	
<b>Housing</b>	Brass or 316 Stainless Steel
<b>Piston</b>	
<b>In Brass Housing</b>	Polysulfone for water; Brass for oil or air
<b>In Stainless Steel Housing</b>	316 Stainless Steel Only
<b>Spring</b>	316 Stainless Steel
<b>O-Ring</b>	Viton®
<b>Other Wetted Parts</b>	Epoxy
Pressure Rating	
<b>Operating</b>	1000 PSIG (69 bar)
<b>Proof</b>	2500 PSIG (172 bar)
<b>Burst</b>	5000 PSIG (345 bar)
Operating Temperature	
<b>With Brass or S.S. Piston</b>	-20°F to +300°F (-29°C to +148.9°C)
<b>With Polysulfone Piston</b>	-20°F to +225°F (-29°C to +107.2°C)
<b>Repeatability</b>	1% Maximum Deviation
<b>Set Point Accuracy</b>	±10% Maximum
<b>Set Point Differential</b>	15% Maximum
<b>Switch*</b>	SPDT, 20 VA
<b>Inlet/Outlet Ports</b>	1/2" NPT
<b>Electrical Termination</b>	No. 18 AWG, 24" L., Polymeric Lead Wires

\*See "Electrical Data" on Page X-5 for more information.

## Air/Gas Flow Adjustment Ranges

Water or oil flow units should not be utilized for air/gas applications. The FS-10798 Gas Flow configuration utilizes a special dash-pot piston for reliability. The flow adjustment ranges are typical for air service. For other gases, the flow range will vary with the density of the gas. Please consult factory for more information.

<b>For 5 PSIG Line*</b>	1 to 75 SCFM Approx.
<b>For 100 PSIG Line</b>	3 to 160 SCFM Approx.

\* Minimum 5 PSI line pressure required.



Shown with optional 1/2" conduit connector.



U.L. Recognized — File No. E31926  
 CSA Listed — File No. LR30200

## Dimensions

### With Wire Leads and Strain Relief

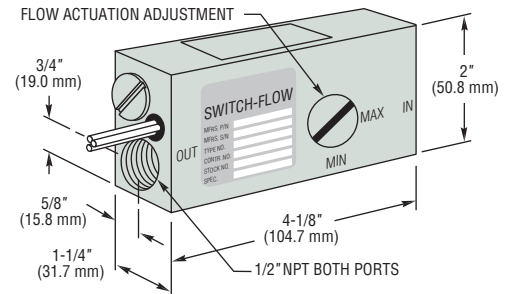

### With 1/2" NPT Conduit Connector

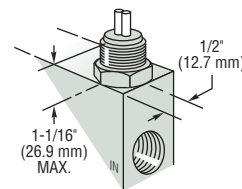

FLOW SWITCHES

**How It Works**

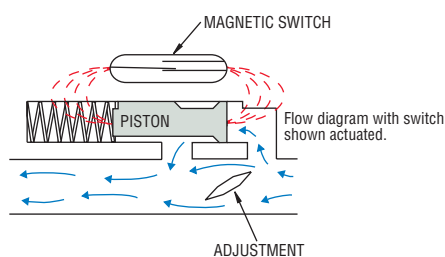
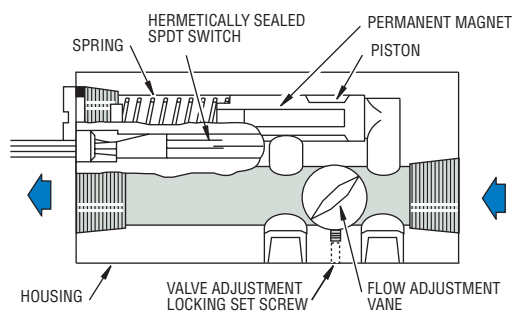

An externally rotatable vane is positioned in the main flow path within the unit. The magnet carrier piston is located in a bypass flow chamber. Pressure differential, caused by flow around the adjusting vane, displaces the spring-biased piston which actuates a hermetically sealed SPDT reed switch within the unit.

**How To Order – Standard Models**

Specify Part Number based on desired media, piston material and electrical termination.

Media	Materials		Part Numbers	
	Housing	Piston	With Lead Wires	With 1/2" Conduit Connector
Liquids	Brass	Brass (for Oils)	61205 ⚡	49073 ⚡
		Polysulfone (for Water)	25357 ⚡	25363 ⚡
		316 Stainless Steel	25358 ⚡	25364 ⚡
Gases		Brass	25359 ⚡	25365 ⚡
		316 Stainless Steel	25360 ⚡	25366 ⚡

**Notes:**

1. Temperature changes will slightly affect the standard water or gas flow settings listed. Oil flow settings will vary with temperature and viscosity.
2. Use of 50 micron filtration is recommended.

⚡ – Stock Items.

**Pressure Drop - Typical**

0.5 GPM

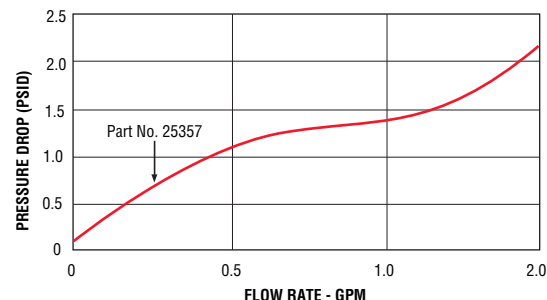

10 GPM and 20 GPM

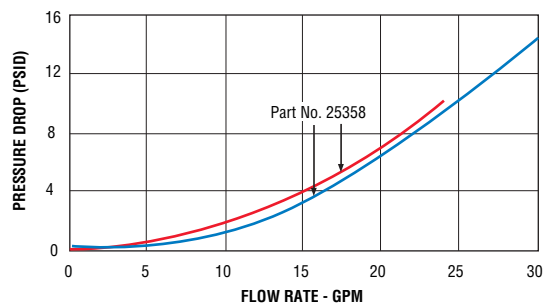

Tests conducted with units in horizontal position with water at +70°F (21°C). Data will vary slightly for vertically mounted units.

**FS-10798 switches are U.L. Approved for Class I, Division 2, Groups A, B, C, D hazardous locations. U.L. Approved — File No. E183854**

**Standard Wiring Color Code**

Wire Color	Terminal
Orange	N.O.
Black	Common
Red	N.C.



# FS-930 Series – Oil Flow Switch, Compensates For Viscosity Change In Fluids

**Flow Rate Settings:** 0.1 GPM to 1.0 GPM  
**Port Size:** 1/4" NPT  
**Primary Construction Material:** Brass  
**Setting Type:** Fixed



A unique, patented piston design assures accuracy within 20% over a full range of viscosities—from 40 to 1000 SSU. Ideal for use in applications where liquids of different viscosities are blended; or for use in lubrication systems where oil flow monitoring is critical at start-ups. Switch compensates for viscosity changes automatically. Each unit is factory preset, using 300 SSU oil, for actuation at specified flow rates.

## Specifications

<b>Wetted Materials</b>	
Housing	Brass
Piston	Brass
Spring	316 Stainless Steel
O-Ring	Viton®
Other Wetted Parts	Epoxy
<b>Pressure Rating</b>	
Operating, Maximum	1000 PSIG (69 bar)
Proof	2500 PSIG (172 bar)
Burst	5000 PSIG (345 bar)
Operating Temperature	-20°F to + 300°F (-29°C to +148.9°C)
Repeatability	1% Maximum Deviation**
Set Point Accuracy	±10%
Set Point Differential	15% Maximum
Switch*	SPDT, 20 VA
Inlet/Outlet Ports	1/4" NPT
Electrical Termination	No. 18 AWG, 24" L., Polymeric Lead Wires
Explosion-Proof Approvals	U.L. Approved for Class I, Division 2, Groups A, B, C, D. Also available with FM approved, explosion proof junction box for Class I, Division 1, Group D hazardous locations. U.L. Approved — File No. E183854

\* See "Electrical Data" on Page X-5 for more information  
 \*\* Reference at 300 SSU set point.



U.L. Recognized —  
File No. E31926



## Dimensions

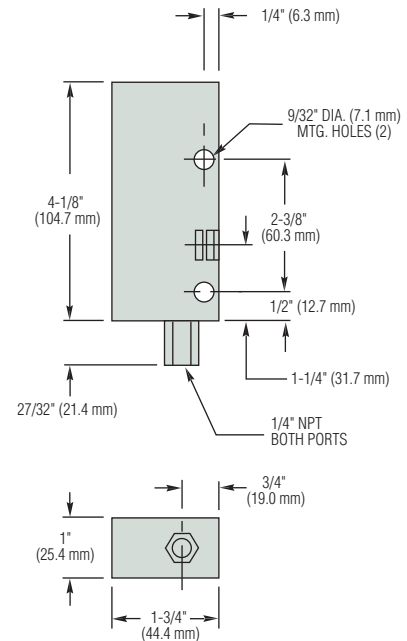

## Electrical Connection, 1/2" NPT Conduit

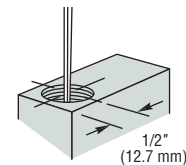

### How To Order – Standard Models

Specify Part Number based on flow setting.

Flow Setting GPM, ±10%	Part Numbers
0.10	<b>51582</b> ⚡
0.25	<b>51586</b> ⚡
0.50	<b>51590</b>
0.75	<b>51594</b>
1.00	<b>51598</b>

**Notes:**

1. Flow settings are calibrated in a vertical position (lead wires up) with 300 SSU oil. Set points will be maintained within 20% of settings in a liquid viscosity range of 40 to 1,000 SSU.
2. Use of 50 micron filtration is recommended.

⚡ – Stock Items.

### Pressure Drop – Typical

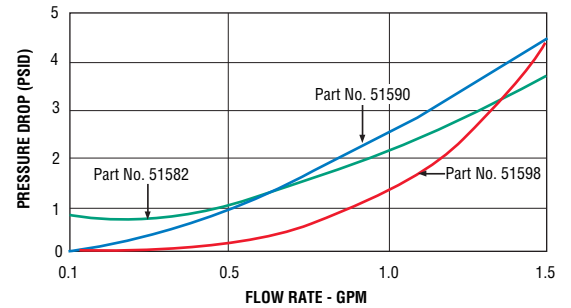

Tests conducted with units in vertical position (lead wires up) with water at +70°F (21°C).

# Shuttle Type Switches – For Moderate to High Liquid Flow Rates

- ▶ Models for flow rate settings from .5 GPM to 100.0 GPM
- ▶ Rugged housings with port sizes ranging from 3/4" NPT to 3" NPT
- ▶ Efficient flow paths assure low line pressure drop at full flow

## Typical Applications

Protect bearings or gears from loss of lubricant flow. Can reduce maintenance costs on...

- Oil separators • Fuel Systems • Pumps • Compressors • Presses

Provide instant, automatic shutdown if coolant flow falls off in electronics or machinery, such as...

- Heat Exchangers • Semiconductor Manufacturing Equipment
- Induction Furnaces • Radio Transmitters

Assure efficient operation of process systems, including...

- Water Filtration and Reverse Osmosis • Chlorinators • De-icers
- Sterilizers • Evaporators

## Design Data

### General Operating Principle (FS-200 Series Shown)

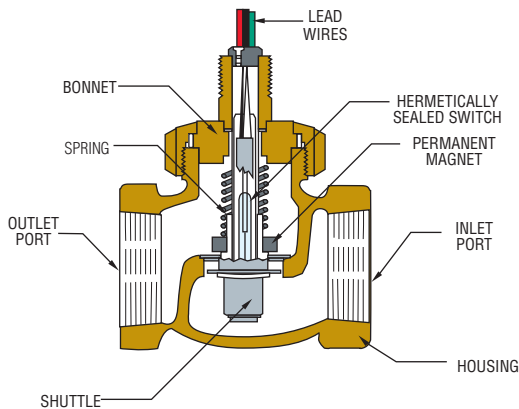

As liquid flow increases to the actuation setting, a magnet-equipped shuttle is displaced. When displaced by fluid flow, this shuttle actuates a hermetically sealed, SPDT or SPST reed switch within the unit stem. A compression spring or gravity provides shuttle return when flow decreases.

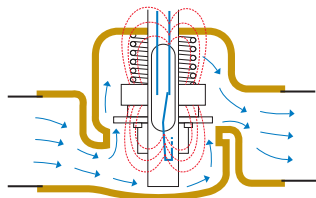

This reed switch, when actuated, can be used to operate remote alarms or indicators, or may be integrated into automatic system controls.

Typical flow diagram showing switch actuated.

### 90° Flow Path Versions

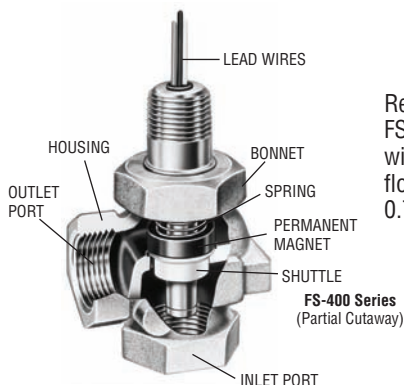

Replace an ordinary 90° pipe joint with an FS-400 Series switch to monitor liquid flow with 1% repeatability. A choice of seven flow rate actuation settings ranging from 0.75 GPM to 10.0 GPM are offered.

### Adjustable Versions

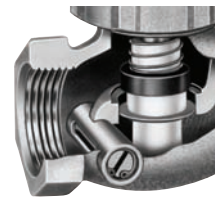

**FS-200 Adjustable**  
(Partial view)

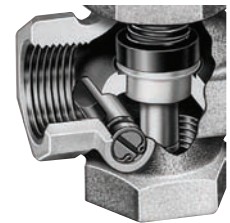

**FS-400 Adjustable**  
(Partial view)

Adjustable versions of the FS-200 and FS-400 Flow Switches incorporate an internal adjustable bypass vane which is controlled externally using an ordinary, flat-blade screwdriver. As the bypass vane is rotated to its open position, an increasing amount of liquid is allowed to bypass the shuttle assembly, resulting in the need for a higher rate of flow to actuate the switch; closing the adjustable bypass vane results in switch actuation at lower flow rates. Switch actuation can be set from 0.75 GPM to 15 GPM.

Regulating action of the bypass vane is shown here for the FS-400 Adjustable unit, and functions the same in the FS-200 Adjustable versions.

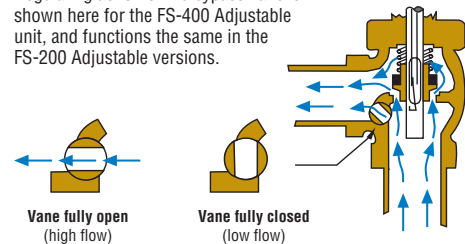

**Vane fully open**  
(high flow)

**Vane fully closed**  
(low flow)

All Plastic, Transparent Versions

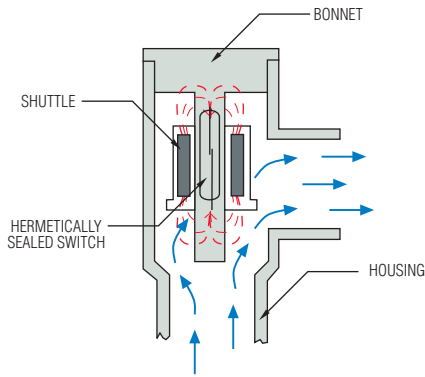

The FS-400P Series is an inexpensive alternative for plastic piping systems. Units are available in clear PVC housings. The clear version, with a bright red shuttle, provides highly visible affirmation of flow status. Low-cost, all PVC versions are for use in systems where liquid pressures are below 120 PSIG and temperatures do not exceed 120°F. An easily removed, one-piece bonnet and shuttle assembly for quick clean-out is featured.

Typical Bonnet and Shuttle Removal

While a slight accumulation of foreign material within shuttle type units will not affect operation, 150 micron filtration is suggested. Any sizable amount of contamination should be removed. Removing the bonnet nut on FS-200, and FS-400 Series units allows the shuttle assembly to be removed for cleaning without disturbing the installation. Sliding keys on the FS-400P are removed, or the bonnet is twisted on the FS-500, for the one-piece bonnet/shuttle to be lifted out of its housing. Consult the factory for replacement parts. Damaged electrical components must be replaced at the factory.

FS-400P Series

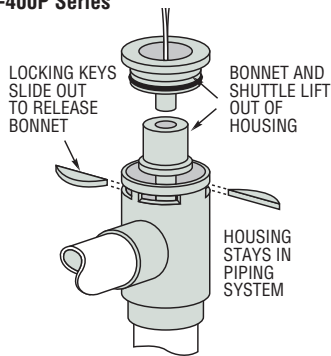

FS-500 Series

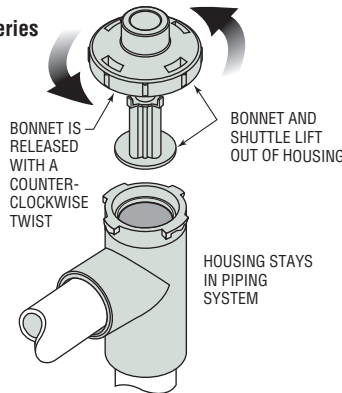

Contents	Page Start
FS-200 Series	
General Purpose, Straight-Through Flow Path .....	G-18
FS-200 Series Adjustable	
Externally Adjustable	
Actuation Set Point .....	G-18
FS-400 Series	
General Purpose, 90° Flow Path .....	G-20
FS-400 Series Adjustable	
Externally Adjustable	
Actuation Set Point .....	G-20
FS-400P Series	
Low-Cost, All PVC .....	G-21
FS-500 Series	
Low-Cost, All Polypropylene .....	G-22

# FS-200 Series – General Purpose, Straight-Through Flow Path



**Flow Rate Settings:** Fixed: 0.5 GPM to 100.0 GPM  
Adjustable: 1.0 GPM to 15.0 GPM

**Port Size:** 1" NPT to 2" NPT

**Primary Construction Material:** Bronze or Stainless Steel

**Setting Type:** Fixed or Adjustable

The FS-200 Series offers accurate flow detection, with 1% repeatability, over a broad range of flow settings and port sizes. Its durable construction delivers long-life reliability in either water or oil. Generous flow paths keep pressure drop low. These switches are ideal for detection of improper flow rates in high volume lubrication, cooling or process systems.

FS-200 Adjustable Series switches offer the same accuracy and are as rugged as those with fixed settings, but provide one additional feature: external adjustability. With these versatile switches your choice of flow settings is diverse within a given range. An ordinary, flat-blade screwdriver is all that's required for the actuation adjustment.

## Specifications

Wetted Materials	
<b>Housing</b>	
FS-200	Bronze or 316 Stainless Steel
FS-200 Adjustable	Bronze
<b>Shuttle</b>	Teflon®
<b>Bonnet</b>	Bronze or Stainless Steel
<b>Spring</b>	316 Stainless Steel
<b>Other Wetted Parts</b>	Viton®, Ceramic
<b>Pressure Rating</b>	
Operating	400 PSIG (27.6 bar) @ 100°F (37.8°C)
Proof	800 PSIG (55.2 bar) @ 100°F (37.8°C)
<b>Operating Temperature</b>	
FS-200	-20°F to +300°F (-29°C to +148.9°C)
FS-200 Adjustable	-20°F to +200°F (-29°C to +93.3°C)
<b>Repeatability</b>	1% Maximum Deviation
<b>Set Point Accuracy</b>	±10%
<b>Set Point Differential</b>	15% Maximum
<b>Switch*</b>	SPDT, 20 VA
<b>Electrical Termination</b>	No. 18 AWG, 24" L., Polymeric Lead Wires Red NC, Black Common, Orange NO

\*See "Electrical Data" on Page X-5 for more information.

## FS-200 Series

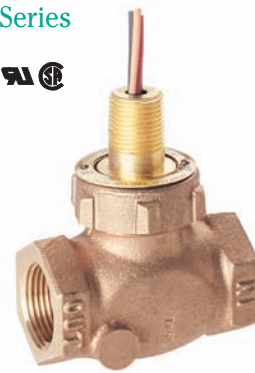

U.L. Recognized  
File No. E31926  
CSA Listed —  
File No. LR30200  
and LR22666  
FM Approved —  
File No. 0A8A3.AE  
and 1H3A2.AX

## FS-200 Adjustable

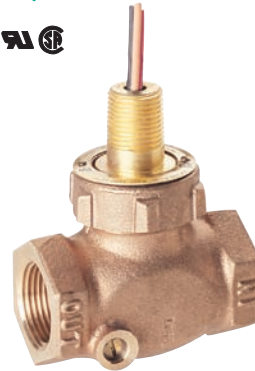

U.L. Recognized  
File No. E31926  
CSA Listed —  
File No. LR22666  
FM Approved —  
File No. 0Q2A8.AE

## Dimensions

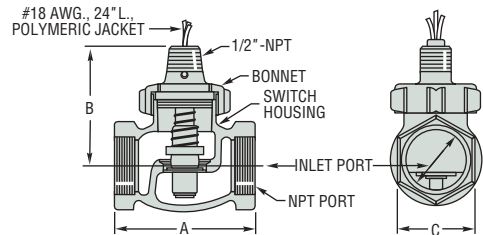

Model	Port Size NPT	A inch (mm)	B inch (mm)	C Hex inch (mm)
FS-200 and FS-200 Adjustable	1"	3-1/4 (82.6)	3 (76.2)	1-25/32 (45.2)
	1-1/4"	4 (101.6)	3-3/16 (80.9)	2-3/16 (55.5)
	1-1/4" ss	4-1/2 (114.3)	3-3/16 (80.9)	2-3/16 (55.5)
	1-1/2"	4-1/2 (114.3)	3-1/2 (88.9)	2-1/2 (63.5)
	2"	5-3/8 (136.5)	4 (101.6)	3-3/32 (78.5)

### Notes:

- Adjustable versions available in 1 inch port sizes only.
- Standard calibration is in water with units in a horizontal position.
- Viscosity changes will affect setpoints. Typically, as viscosity increases setpoints will decrease.
- Consult Gems for special applications.



How To Order – Standard Models

Specify Part Number for the FS-200 Series based on desired housing material, port size and flow setting, or based on flow setting range for FS-200 Adjustable versions.

FS-200 Series

Port Size NPT	Flow Setting GPM	Part Numbers	
		Bronze	Stainless Steel
1"	0.5	27051 ⚡	27059 ⚡
	1	27052 ⚡	27060
	2	27053 ⚡	27061
	3	27054 ⚡	27062
	4	27055 ⚡	27063
	5	27056 ⚡	27064
	6	27057 ⚡	27065
	8	27058 ⚡	27066
1-1/4"	1	27067 ⚡	27076
	2	27068	27077
	4	27069	27078
	6	27070	27079
	8	27071	27080
	10	27072	27081
	12	27073	27082
	16	27074	27083
20	27075	27084	

Port Size NPT	Flow Setting GPM	Part Numbers	
		Bronze	Stainless Steel
1-1/2"	1.5	27085 ⚡	27093
	3	27086	27094
	5	27087	27095
	7.5	27088	27096
	10	27089	27097
	15	27090	27098
	20	27091	27099
	30	27092	27100
2"	2	27101 ⚡	27109
	4	27102	27110
	5	27103	27111
	10	27104	27112
	15	27105	27113
	25	27106	27114
	35	27107	27115
	50	27108	27116

FS-200 Adjustable

Port Size NPT	Flow Setting Adjustment Range GPM	Part Numbers
1"	1.0-6.0	26615 ⚡
	5.0-15.0	26616 ⚡
	2.0-8.0	26838 ⚡

Notes:

- Flow settings for fixed versions are calibrated using water at +70°F on increasing flow, with units in a horizontal position (lead wires up). Consult factory regarding special flow setting calibration, or liquids other than water. Temperature changes will slightly affect the flow settings listed. Oil flow settings will vary with viscosity.
  - Adjustable units that are set to customer specification are subject to GEMS test stand accuracy.
  - Use of 150 micron filtration is recommended.
  - Minimum 5 PSI line pressure required.
- ⚡ – Stock Items.

Pressure Drop - Typical

1" NPT and 1-1/2" NPT Ports

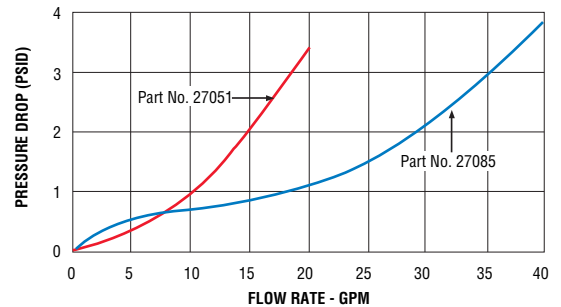

2" NPT Ports

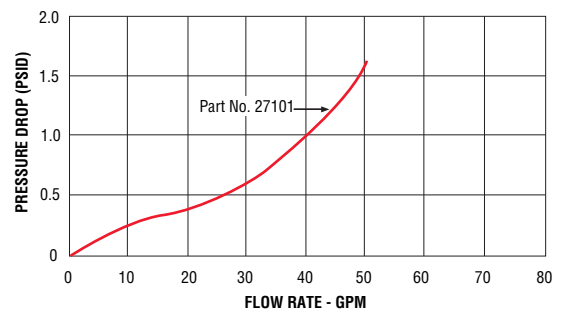

Tests conducted with units in horizontal position (lead wires up) with water at +70°F (21°C).

FS-200 Series Flow Switches are U.L. Approved for Class I, Division 2, Groups A, B, C, D hazardous areas.



They are also available with FM-approved, explosion-proof junction box for Class I, Division 1, Group D hazardous locations. Units must be completely assembled at GEMS. U.L. Approved — File No. E183854

For Remote Alarms – See Page E-30

- Adjustable Volume
- Indoor Outdoor
- Solid-State



# FS-400 Series – General Purpose, 90° Flow Path

**Flow Rate Settings:** Fixed Version: 0.75 GPM to 10.0 GPM  
Adjustable Version: 0.75 GPM to 14.0 GPM

**Port Size:** 3/4"

**Primary Construction Material:** Bronze

**Setting Type:** Fixed or Adjustable

Provides accurate flow detection in water and oil with 1% repeatability. Flow settings on the adjustable version can be easily changed without disassembly. A shuttle by-pass vane inside the housing is controlled externally using an ordinary flat-blade screwdriver. These switches are ruggedly constructed of non-corrosive materials and resist shock and vibration. Suitable for triggering alarms on interlocking shutdown circuitry when flow rate is improper to protect bearings, gears and cooling systems.

## Specification

<b>Wetted Materials</b>	
Housing	Bronze
Shuttle	Delrin®
Spring	316 Stainless Steel
O-Ring	Viton®
Other Wetted Parts	Ceramic
<b>Pressure Rating, Maximum</b>	
Operating	400 PSI (27.6 bar) @ 100°F (+37.8°C)
Proof	800 PSI (55.2 bar) @ 100°F (+37.8°C)
<b>Operating Temperature</b>	
	-20°F to +180°F (-29°C to +82.2°C)
<b>Repeatability</b>	
	1% Maximum Deviation
<b>Set Point Accuracy</b>	
	±10%
<b>Set Point Differential</b>	
	15% Maximum
<b>Switch*</b>	
	SPDT, 20 VA
<b>Inlet/Outlet Ports</b>	
	3/4" NPT
<b>Electrical Termination</b>	
	No. 18 AWG, 24" L., Polymeric Lead Wires

\*See "Electrical Data" on Page X-5 for more information.

## How To Order – Standard Models

Specify Part Number based on flow settings for the FS-400 Series, based on flow setting range for the FS-400 Adjustable version.

### FS-400 Series

NPT	Flow Setting GPM	Part Numbers
3/4"	0.75	26440 ⚡
	1.5	26441 ⚡
	2.0	26442 ⚡
	2.5	26443 ⚡
	5.0	26444 ⚡
	7.5	26445 ⚡
	10.0	26446 ⚡

### FS-400 Adjustable

NPT	Flow Setting GPM	Part Numbers
3/4"	0.75-4.0	26600 ⚡
	2.0-8.0	26601 ⚡
	7.0-14.0	26602 ⚡

#### Notes:

- Flow settings for Fixed Version are calibrated using water at +70°F on increasing flow, with units in a vertical position (lead wires up). Temperature changes will slightly affect the flow settings listed.
- Adjustable units that are set to customer specifications are subject to GEMS test stand accuracy.
- Use of 150 micron filtration is recommended.
- Minimum 5 PSI line pressure required.

⚡ – Stock Items.

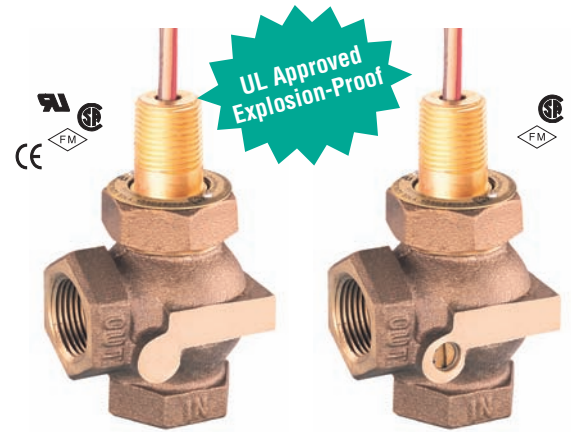

**FS-400 Series**

U.L. Recognized —  
File No. E31926  
CSA Listed —  
LR30200 and LR22666  
FM Approved —  
File No. 0A8A3.AE and  
1H3A2.AX

**FS-400 Adjustable**

CSA Listed —  
File No. LR22666  
FM Approved —  
File No. 0A8A3.AE

## Dimensions

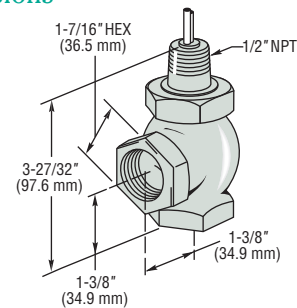

## Pressure Drop - Typical

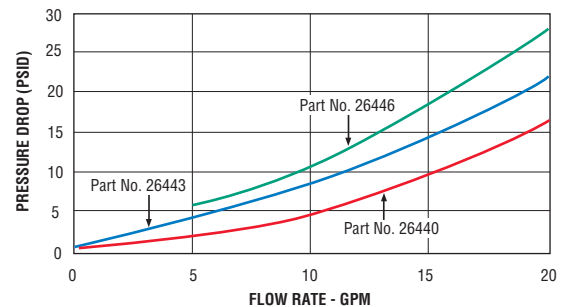

Tests conducted with units in vertical position (lead wires up) with water at +70°F (21°C).

**FS-400 switches are U.L. Approved for Class I, Division 2, Groups A, B, C, D hazardous areas.**

Available with FM-approved, explosion-proof junction box for Class I, Division 1, Group D hazardous locations. Units must be assembled completely at GEMS.

U.L. Approved — File No. E183854

# FS-400P Series – Low Cost Units for Plastic Piping

**Flow Rate Settings:** 0.5 GPM or 2.0 GPM  
**Port Size:** 3/4" or 1" IPS  
**Primary Construction Material:** Clear PVC  
**Setting Type:** Fixed

Designed for low cost flow/no-flow monitoring. This series is available with a clear transparent PVC housing which is ideal for use where visual flow confirmation is desirable. These corrosion-resistant switches offer broad chemical compatibility. With only one moving part, their rugged construction offers long life with minimum maintenance. Ideal for water heating or purification, equipment cooling and general chemical processing use.

## Specifications

<b>Materials</b>	
Housing, Shuttle and Bonnet	PVC
O-Ring	Buna N
Other Wetted Parts	Epoxy
<b>Operating Pressure, Maximum</b>	
	120 PSIG (8.3 bar) @ +70°F to +100°F @ +21°C to +37.8°C
	50 PSIG (3.4 bar) @ +101°F to +120°F @ +38.3°C to +48.9°C
<b>Operating Temperature, Maximum Clear Version</b>	
	+120°F (+48.9°C)
<b>Set Point Accuracy</b>	± 20%
<b>Set Point Differential</b>	20% Maximum
<b>Switch*</b>	SPST, 20 VA N.O. @ No Flow
<b>Inlet/Outlet Ports</b>	3/4" or 1" IPS and 1/2" NPT
<b>Mounting Attitude</b>	Vertical, Inlet Down
<b>Electric Termination</b>	No. 22 AWG, 24" L., PVC Lead Wires

\*See "Electrical Data" on Page X-5 for more information.

## How To Order – Standard Models

Specify Part Number based on material and port size.

PVC Material	Port Size	Actuation on Increasing Flow	Part Numbers
Clear	1/2" NPT*	0.5 GPM ±20%	135805 ⚡
	3/4" IPS	0.5 GPM ±20%	135810 ⚡
	1" IPS	2.0 GPM ±20%	135815 ⚡

\*3/4" IPS model with 1/2" NPT port adapter installed.

Notes:

- Care should be taken by specifiers to ensure fluid compatibility with the above listed wetted materials.
- Use of 150 micron filtration is recommended.

⚡ – Stock Items.



U.L. Recognized —  
 File No. E31926  
 CSA Listed —  
 File No. LR30200

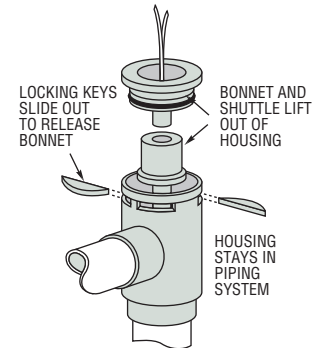

Cleanout is quick and easy. Two locking keys slide out to allow removal of a one-piece bonnet and shuttle assembly. Housing and piping are left undisturbed.

## Dimensions

3/4" IPS Size (Both Ports)

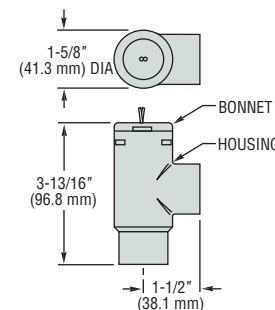

1" IPS Size (Both Ports)  
 (All other dimensions are the same as 3/4" size)



1/2" NPT

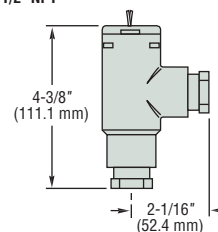

## Pressure Drop - Typical

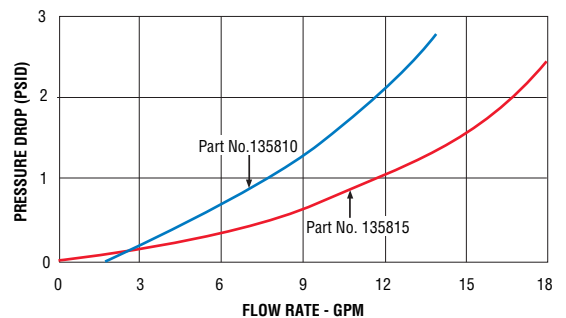

Tests conducted with units in vertical position (lead wires up) with water at +70°F (21°C).

# FS-500 Series – Low Cost Units for Threaded Plastic Piping

**Flow Rate Settings:** 0.25 GPM to 5.0 GPM  
**Port Size:** 3/4" NPT  
**Primary Construction Material:** Polypropylene  
**Setting Type:** Fixed

The FS-500 offers low cost flow monitoring with a variety of switch actuation points and low pressure drop. All wetted parts are polypropylene or stainless steel, making this switch ideal for a wide range of chemical and temperature requirements. The materials are also NSF or FDA approved for potable water treatment applications including chlorinators, purifiers and heaters. The FS-500 is ideal for equipment cooling including welders, lasers, etc. A J-box version with a 5 amp relay is also available for direct control of higher electrical loads, such as chlorinator pumps.

## Specifications

<b>Wetted Materials*</b>	
<b>Housing, Bonnet, Shuttle, Shuttle Cap</b>	Polypropylene, Hydrolytically Stable
<b>O-Ring</b>	Viton® or Buna N
<b>Spring</b>	316 Stainless Steel
<b>Retaining Clip</b>	PH 15-7 Mo Stainless Steel
<b>Operating Pressure, Maximum</b>	100 PSIG (6.9 bar) @ +70°F (21°C) 50 PSIG (3.4 bar) @ +180°F (82°C) 40 PSIG (2.8 bar) @ +212°F (100°C)
<b>Operating Temperature, Maximum</b>	0° to 212°F (100°C)
<b>Set Point Accuracy</b>	± 20%
<b>Set Point Differential</b>	± 20% Maximum
<b>Switch**</b>	SPST, N.O. Pilot Duty 20 VA, 120-240 VAC or VDC
<b>J-Box with 5A Relay</b>	
<b>Coil</b>	120 VAC 50/60 Hz
<b>Contacts SPDT</b>	5A – 240 VAC Res 1/3 HP – 120 VAC 5A – 28 VDC Res.
<b>Inlet/Outlet Ports</b>	3/4" Female NPT
<b>Electric Termination Pilot</b>	No. 22 AWG, 24" Zip Cord Lead Wires
<b>J-Box</b>	6' PVC Cable

\* Materials of Construction are available for FDA or NSF Compliance.  
 \*\* See "Electrical Data" on Page X-5 for more information.

## How To Order – Standard Models

Specify Part Number based on switch actuation set point. Set points other than those listed are available as special order; contact GEMS with your requirements. Normally closed switch logic units available as special orders.

Switch Actuation Set Point GPM	Part Numbers	
	Pilot Duty	J-Box w/5A Relay
0.25	170231 ⚡	175901 ⚡
0.50	170232 ⚡	175902 ⚡
1.00	170233 ⚡	—
2.00	175117 ⚡	—
2.50	170234 ⚡	—
5.00	170235 ⚡	—

Note: Use of 100 micron filtration is recommended.

⚡ – Stock Items.

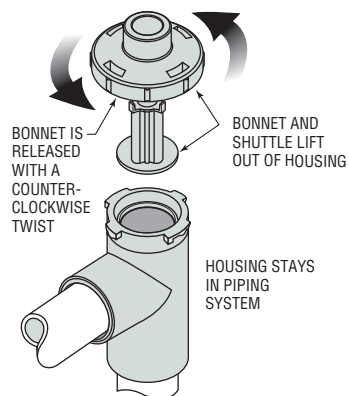

## Dimensions

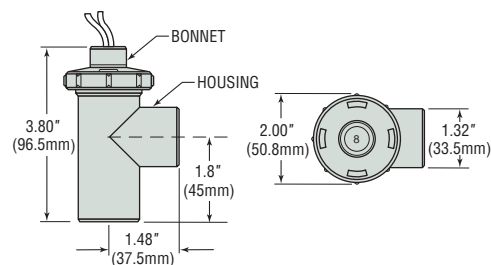

## Pressure Drop - Typical

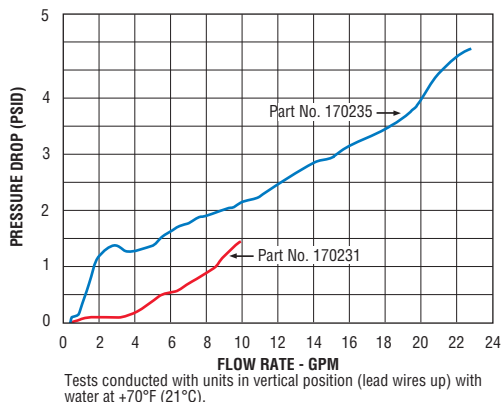

# Paddle Type Flow Switches – For Flow/No-Flow Detection in Large Line Sizes

- ▶ Engineered for positive liquid flow detection at pressures to 2000 PSIG (138 bar)
- ▶ Unique, patented cam design assures low pressure drop and does not require bellows, seals, or mechanical linkages
- ▶ Minimum in-line restriction; paddle pivots to move out of liquid path with increasing flow

## Typical Applications

Assure flow and/or leak detection in large, high pressure in...

- Compressors • Heat Exchangers • Turbines • Engines • Boilers • Chillers

Protect high or low pressure pumps from cavitation, sense critical, reverse flow and protect...

- Valves • Pumps • Regulators

Contents	Page Start
FS-550 Series	
High Pressure, Metal Version .....	G-24

## Design Data

### General Operating Principle

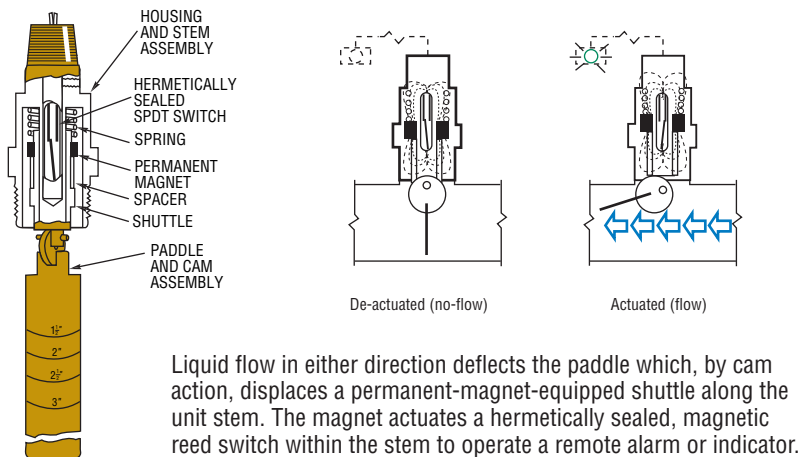

Liquid flow in either direction deflects the paddle which, by cam action, displaces a permanent-magnet-equipped shuttle along the unit stem. The magnet actuates a hermetically sealed, magnetic reed switch within the stem to operate a remote alarm or indicator.

## Simple Installation and Easy Maintenance

Installs in a standard pipe tee or reducing fitting. If excessive particle build-up necessitates occasional cleaning, simply remove the unit and manually remove particles actuate paddle for free movement.

### Easy Installation

Installs in a standard pipe tee or reducing fitting.

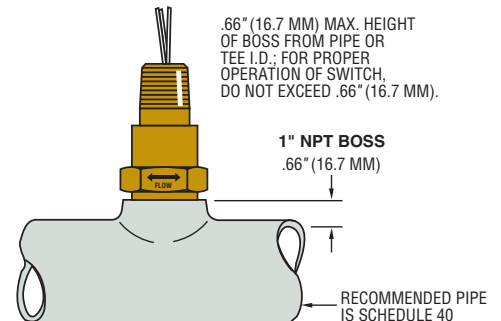

## Paddles Cut-to-Length For Broad Range of Pipe Sizes

Cutting the paddle to length selects a standard flow rate as shown on the tables on the following pages. Approximate pipe sizes are marked on the paddle. These units can be used in pipe with diameters greater than the 5" paddle length. They provide flow/no-flow detection where there is a velocity of 0.5 ft. per second.

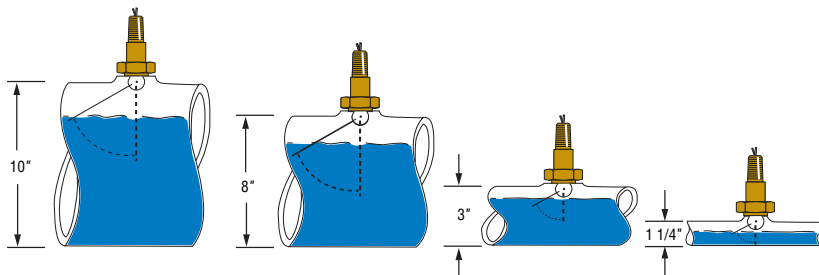



# FS-550 Series – High Pressure, Metal Paddle Switch

**Pipe Line Size:** 1-1/4" and Up  
**Primary Construction Material:** Stainless Steel or Brass  
**Setting Type:** Fixed

Standard FS-550 switches sense liquid flow in either direction to monitor flow/no-flow conditions. They are supplied in two paddle lengths. The paddle is trimmed during installation to permit switch actuation at the desired flow rate. As flow increases in a pipe, the paddle of the switch pivots to move out of the liquid path, producing less than 3 PSIG of pressure drop regardless of pipe size.

## Specifications

<b>Wetted Materials</b>	
<b>Housing</b>	Brass or 316 Stainless Steel
<b>Paddle</b>	302 Stainless Steel
<b>Spring</b>	316 Stainless Steel
<b>Other Wetted Parts</b>	Ceramic and Teflon®
<b>Operating Pressure, Maximum</b>	2000 PSIG (138 bar)
<b>Pressure Drop</b>	3 PSIG (0.2 bar) Maximum
<b>Operating Temperature</b>	-30°F to + 300°F (-34.4°C to + 148.9°C)
<b>Set Point Accuracy</b>	± 25%
<b>Switch*</b>	SPDT, 20 VA
<b>Repeatability</b>	± 5%
<b>Electrical Termination</b>	No. 18 AWG, 24" L., Polymeric Lead Wires

\* See "Electrical Data" on Page X-5 for more information.

## Standard Actuation and De-actuation Set Points

The Table below indicates paddle lengths which achieve switch actuation for specific flow rates. Approximate pipe line sizes are marked on paddle.

	Pipe Size Marked at Paddle Cut-Off Point	Pipe Line Sizes					
		1-1/4"	1-1/2"	2"	2-1/2"	3"	4"
		Approximate Actuation and (De-Actuation) Flow Rates GPM Water					
<b>Short Paddle Unit</b>	1-1/4"	5 (3)	13 (8)	22 (15)	29 (22)	—	—
<b>Long Paddle Unit</b>	1-1/2"	—	15 (11)	28 (21)	38 (30)	—	—
	2"	—	—	22 (15)	27 (20)	48 (38)	—
	2-1/2"	—	—	—	21 (14)	40 (26)	52 (39)
	3"	—	—	—	—	31 (20)	45 (32)
	4"	—	—	—	—	—	39 (25)

All flow rate tests for the above table were conducted with the switch installed in a standard "T" fitting. For calculation of flow rates in pipe sizes larger than 5", a flow velocity of approximately 0.5 ft. per sec. actuates the switch with a full length (5") paddle. The paddle can be trimmed to achieve different actuation points.

## How To Order – Standard Models

Select switch type, paddle length and housing material, then specify adjacent part number.

Switch Type	Paddle Length	Housing Material	Switch Operation	Part Numbers	
				Standard	3-Pin J-Box
SPDT Standard Unit	Long	Brass	N.O. or N.C.	29609	56730
		316 S.S.		29608	56729
	Short	Brass		30641	66914
		316 S.S.		30640	61189

Note: The FS-550 Switch is not recommended for use with 1" plastic tees.



U.L. Recognized  
 File No. E31926  
 CSA Listed —  
 File No. LR30200  
 and LR22666  
 FM Approved —  
 File No. 0A8A3.AE  
 and 1H3A2.AX

## Dimensions

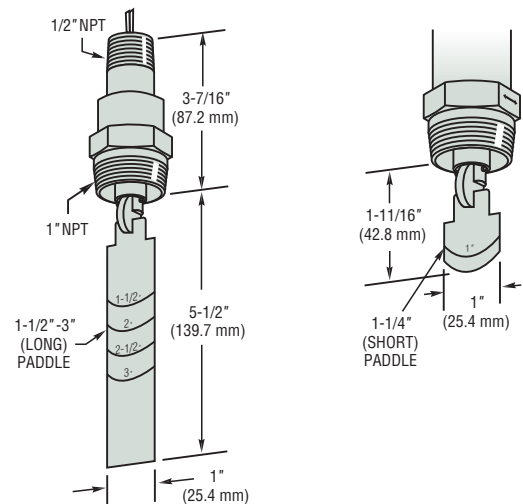

FLOW SWITCHES

## FS-550 switches are U.L. Approved for Class I, Division 2, Groups A, B, C, D hazardous areas.

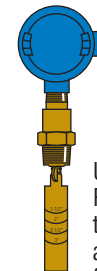

They are also available as FM-approved when used with GEMS Junction Boxes which are explosion-proof for Class I, Division 1, Groups B, C, D, E, F, G hazardous locations.

Using GEMS SAFE-PAK Relays and barriers, these switches provide automatic flow/no flow interlock and are intrinsically-safe without explosion-proof housing and piping.

U.L. Approved — File No. E183854

