

Terminals, P-Series

Terminals, P-Series	Overview P-Series	B.2
	Feed-through terminals	B.4
	Modular PE terminals	B.8
	Double level terminals	B.11
	Test disconnect terminals	B.14
	Neutral conductor disconnect terminals	B.19
	Installation terminals	B.21
	Accessories P-Series	B.26

P-Series / Push-In connection technology

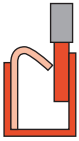

Sometimes a little means a lot

The P-Series is Weidmüller's new generation of modular terminals distinguished by concise yet uniquely flexible portfolio. The cornerstones of this concept is the "Push In" connection technology which enable a reduction in the terminal variants whilst providing incredible cost savings. What this means is that the three terminal types PDU 2.5/4, PDU 6/10 and PDU 16 can provide you with rational wiring solutions up to 16 mm². In the past you would have needed five different types of terminal. This innovative product concept is the result of targeted detail engineering. With a width of 5.1 mm, the PDU 2.5/4 and PDL 4 types are the same size as an old 2.5 mm² terminal, but are rated at 32 A – previously only possible with a 4 mm² terminal. The data of the other terminals in the range is equally impressive: PDU 6/10 – 8.1 mm and 57 A; PDU 16 – 12 mm and 76 A. The Weidmüller P-Series gives users a range of modular terminals that unites the performance features of their "big brothers" with the compact size of their "little brothers".

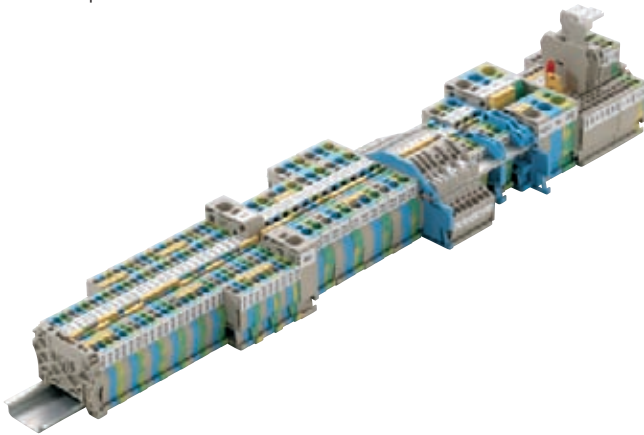

Direct Push In technology for direct savings

Among the impressive features of the direct Push In connection system are minimal wiring times and reliable, simple handling. Compared to the 3-conductor tension clamps, the direct Push In system achieves time-savings of up to 50 % when connecting the conductor (3.5 s per conductor). The stripped solid conductor is simply pushed into the terminal as far as it will go – that's all there is to it. No tools are required, and the result is a reliable, vibration-resistant, gas-tight connection. Even flexible conductors with crimped wire end ferrules or ultrasonic-welded conductors can be connected without any problems.



Views without cage side wall



Product overview

Rated cross-sectional area	P-Series 2.5/4		P-Series 6/10		P-Series 16
	2.5 mm ²	4 mm ²	6 mm ²	10 mm ²	16 mm ²
Feed-through terminals					
2 connections	•	•	•	•	•
3 connections	•	•	•	•	
4 connections	•	•			
Power supply terminals					
2 connections	•	•	•	•	•
3 connections	•	•	•	•	
4 connections	•	•			
Supply terminals					•
Neutral conductor terminals	•	•	•	•	•
Two-tier terminals	•	•			
Three-conductor/distribution terminals	•	•			
Test-disconnect terminals	•	•			
Fuse terminals	•	•			

1 The connection

The compression spring for connecting the conductor is mounted separately on the housing to guarantee galvanic isolation.

- Direct connection of solid conductors.
- Direct connection of flexible conductors with wire end ferrules.

2 Plug-in cross-connections

Rapid, straightforward potential distribution with the ZQV plug-in cross-connection.

- 2- to 10-pole, or “endless” cross-connection for custom assemble.
- Full rated current.
- Breakout poles for bypassing other potentials.

3 Easy to use

The simple Push In system for solid and flexible conductors with wire end ferrules speeds up the wiring time considerably.

- No additional tools required.
- Easy to use in confined installations.
- TOP connection (conductor inserted and connection secured in the same direction).

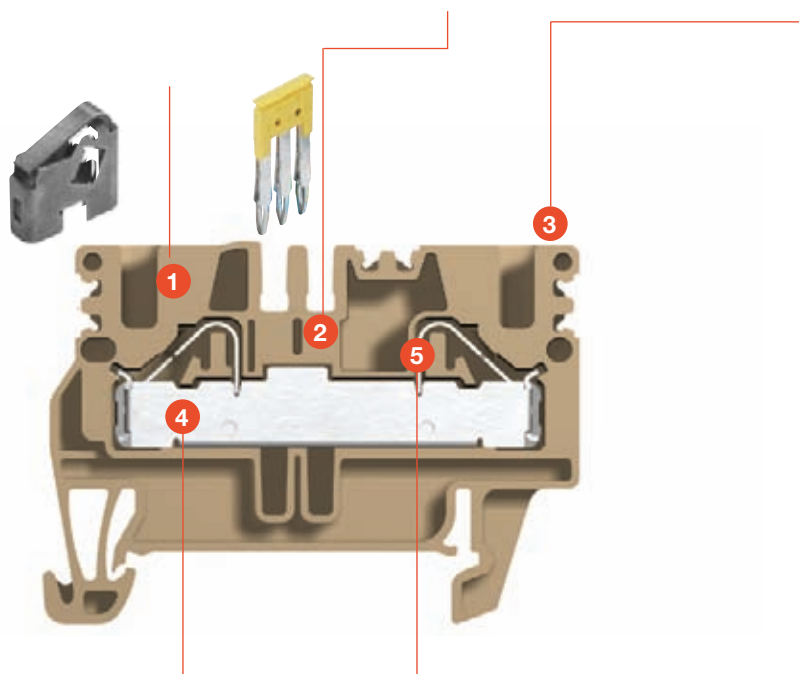

4 Reliable contact

- A stainless steel spring ensures permanent, secure contact between conductor and current bar; higher pull-out forces are achieved when compared with tension clamp terminals.
- The copper/tin alloy current bar makes a perfect connection with the conductor; this guarantees a very low voltage drop.

5 Safe to use

The Push In contact has been designed in such a way that incorrect use is impossible in most cases!

- The **spring stop** protects and limits the travel of the spring; this, together with the plastic housing, defines the exact position of the screwdriver.
- The **conductor stop** positions the end of the conductor in the connection space; it supports the compression spring outside the terminal in the case of large bending radii and guarantees the contact with the current bar.

The Wemid insulating material

- Non-tracking, CTI 600
- Thermally stable up to 120 °C
- V0 flammability rating to UL 94
- Halogen and phosphor free, flame-retardant

Effective product range

The P-Series is characterised by its high performance and a compact unit range. It is therefore ideal for reducing the number of variations and promotes rational procurement and logistics management.

Standards and directives

The excellent reliability of Weidmüller's contacts and systems is confirmed by type testing to IEC 60947-7 and by supplementary tests. In addition, product quality undergoes strict testing in our Quality Assurance department (certified to DIN ISO 9002).

Feed-through terminals

B

In hazardous area applications, the installation instructions and the rated data specifications for accessories given in the technical appendix must be followed.

Width/Length/height with TS35x7.5	mm
max. current / max. cond. cross-section	A/mm ²
Max. clamping range	mm ²

Technical data

Rated data	
Rated voltage	V
Rated current	A
Rated cross-section	mm ²
Rated impulse voltage / Pollution severity	kV/-
Gauge to IEC 60947-1 / UL94 Flammability class	Approvals
Clamped conductors (H05V/H07V)	
solid / stranded	mm ²
flexible / Stranded wire with end ferrules	mm ²
Twin wire-end ferrule	mm ²
Stripping length / Blade size	mm/-
Note	

Ordering data

Version	
	Dark beige Wemid
	Blue Wemid
Note	

Accessories

Pluggable cross-connection	
	2-pole
	3-pole
	4-pole
	10-pole
	20-/24-pole
End plate / partition	
	Dark beige Wemid
End bracket	
	Dark beige Wemid
Test adapter	
	Standard
	With assembly peg
Screwdriver	
	Standard
Reducing sleeves	
	For conductors < 0,5 mm ² / AWG 20
	For conductors < 1,0 mm ² / AWG 18
Cover	
	With lightning flash symbol

Marking systems	
	(see assortment in catalogue 7)
	Marking tags
For detailed information on other accessories and applications, refer to the „Accessories“ section	

PDU 2.5/4

4 mm²

2 connections

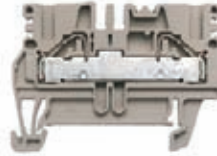

5.1 x 53 x 38	
/ 6	
0.13...6	

IEC 60947-1	Ex e ll		II 2 G D
IEC	UL	CSA	EN 60079-7
800	600	600	550
32	30	30	29
4	AWG 26...10	AWG 26...10	4
		8 / 3	
		/ V-0	
Rated connection			
0.5...6			
0.5...4 / 0.5...4			
0.5...2.5			
12 / 3.0 x 0.5 mm			
4 mm ² conductors should be processed after crimp, in compliance with Euro-Norm EN 60947-1, for example with the PZ6/5 (order no. 9011460000).			

Type	Qty	Order No.
PDU 2.5/4	100	1896110000
PDU 2.5/4 BL	50	1896230000
For use with 4 mm ² conductors, with wire-end ferrules and cross-section-optimized plastic collars (order no. 9203630000)		

Type	current	Qty	Order No.
ZQV 2.5/2	24 A	60	1608860000
ZQV 2.5/3	24 A	60	1608870000
ZQV 2.5/4	24 A	60	1608880000
ZQV 2.5/10	24 A	20	1608940000
ZQV 2.5/20	24 A	20	1908960000
Width			
PAP 2.5/4	3 mm	50	1896300000
ZEW 35	6 mm	20	9540000000
PTA PDU2.5/4	5.1 mm	25	1916180000
PTA ZA PDU2.5/4	5.1 mm	25	1916190000
SD 0.5x3.0x80		1	9008320000
PRH 2.5/4/1		100	1916410000
PRH 2.5/4/2		100	1916400000
PAD 2.5/4/4		80	1916150000

Marking systems	
	DEK 5/5 / WS 10/5
For detailed information on other accessories and applications, refer to the „Accessories“ section.	

PDU 2.5/4 3AN

4 mm²

3 connections



5.1 x 67.5 x 38	
/ 6	
0.13...6	

IEC 60947-1	Ex e ll		II 2 G D
IEC	UL	CSA	EN 60079-7
800	600	600	550
32	30	30	29
4	AWG 26...10	AWG 26...10	4
		8 / 3	
		/ V-0	
Rated connection			
0.5...6			
0.5...4 / 0.5...4			
0.5...2.5			
12 / 3.0 x 0.5 mm			
4 mm ² conductors should be processed after crimp, in compliance with Euro-Norm EN 60947-1, for example with the PZ6/5 (order no. 9011460000).			

Type	Qty	Order No.
PDU 2.5/4/3AN	100	1896120000
PDU 2.5/4/3AN BL	50	1896240000
For use with 4 mm ² conductors, with wire-end ferrules and cross-section-optimized plastic collars (order no. 9203630000)		

Type	current	Qty	Order No.
ZQV 2.5/2	24 A	60	1608860000
ZQV 2.5/3	24 A	60	1608870000
ZQV 2.5/4	24 A	60	1608880000
ZQV 2.5/10	24 A	20	1608940000
ZQV 2.5/20	24 A	20	1908960000
Width			
PAP 2.5/4/3AN	3 mm	50	1896480000
ZEW 35	6 mm	20	9540000000
PTA PDU2.5/4	5.1 mm	25	1916180000
PTA ZA PDU2.5/4	5.1 mm	25	1916190000
SD 0.5x3.0x80		1	9008320000
PRH 2.5/4/1		100	1916410000
PRH 2.5/4/2		100	1916400000
PAD 2.5/4/4		80	1916150000

Marking systems	
	DEK 5/5 / WS 10/5
For detailed information on other accessories and applications, refer to the „Accessories“ section.	

PDU 2.5/4 4AN

4 mm²

4 connections



5.1 x 78.5 x 38
/ 6
0.13...6



IEC 60947-7-1 Ex e II II 2 G D

IEC	UL	CSA	EN 60079-7
800	600	600	550
32	30	30	27
4	AWG 26...10	AWG 26...10	4
8 / 3			
/ V-0			



Rated connection

0.5...6
0.5...4 / 0.5...4
0.5...2.5
12 / 3.0 x 0.5 mm

4 mm² conductors should be processed after crimp, in compliance with Euro-Norm EN 60947-1, for example with the PZ6/5 (order no. 9011460000).

Type	Qty	Order No.
PDU 2.5/4/4AN	100	1896130000
PDU 2.5/4/4AN BL	50	1896250000

For use with 4 mm² conductors, with wire-end ferrules and cross-section-optimized plastic collars (order no. 9203630000)

Type	current	Qty	Order No.
ZQV 2.5/2	24 A	60	1608860000
ZQV 2.5/3	24 A	60	1608870000
ZQV 2.5/4	24 A	60	1608880000
ZQV 2.5/10	24 A	20	1608940000
ZQV 2.5/20	24 A	20	1908960000
Width			
PAP 2.5/4/4AN	3 mm	50	1896320000
ZEW 35	6 mm	20	9540000000
PTA PDU2.5/4	5.1 mm	25	1916180000
PTA ZA PDU2.5/4	5.1 mm	25	1916190000
SD 0.5x3.0x80		1	9008320000
PRH 2.5/4/1		100	1916410000
PRH 2.5/4/2		100	1916400000
PAD 2.5/4/4		80	1916150000

DEK 5/5 / WS 10/5

Detailed information for working with twin ferrules can be found in the P-Series Accessories section.

PDU 2.5/4 2x2

4 mm²

2 x 2 connections



5.1 x 78 x 38
/ 6
0.13...6

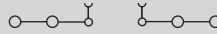

IEC 60947-7-1

IEC	UL	CSA
800	600	600
32	30	30
4	AWG 26...10	AWG 26...10
8 / 3		
/ V-0		

Rated connection

0.5...6
0.5...4 / 0.5...4
0.5...2.5
12 / 3.0 x 0.5 mm

4 mm² conductors should be processed after crimp, in compliance with Euro-Norm EN 60947-1, for example with the PZ6/5 (order no. 9011460000).

Type	Qty	Order No.
PDU 2.5/4/2X2AN	100	1022220000

For use with 4 mm² conductors, with wire-end ferrules and cross-section-optimized plastic collars (order no. 9203630000)

Type	current	Qty	Order No.
ZQV 2.5/2	24 A	60	1608860000
ZQV 2.5/3	24 A	60	1608870000
ZQV 2.5/4	24 A	60	1608880000
ZQV 2.5/10	24 A	20	1608940000
ZQV 2.5/20	24 A	20	1908960000
Width			
PAP 2.5/4/4AN	3 mm	50	1896320000
ZEW 35	6 mm	20	9540000000
PTA PDU2.5/4	5.1 mm	25	1916180000
PTA ZA PDU2.5/4	5.1 mm	25	1916190000
SD 0.5x3.0x80		1	9008320000
PRH 2.5/4/1		100	1916410000
PRH 2.5/4/2		100	1916400000
PAD 2.5/4/4		80	1916150000

DEK 5/5 / WS 10/5

Detailed information for working with twin ferrules can be found in the P-Series Accessories section.

PDU 6/10

10 mm²

2 connections

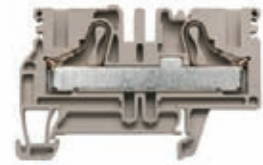

8.1 x 64.5 x 40
/ 10
1.5...10



IEC 60947-7-1

IEC	UL	CSA	EN 60079-7
800	600	600	550
57	44	44	37
10	AWG 16...8	AWG 16...8	6
8 / 3			
/ V-0			



Rated connection

1.5...10
1.5...10 / 1.5...10
14 / 0.6 x 3.5 mm

For use with 10 mm² conductors, with wire-end ferrules and cross-section-optimized plastic collars (order no. 9203620000)

Type	Qty	Order No.
PDU 6/10	50	1896140000
PDU 6/10 BL	25	1896270000

For use with 10 mm² conductors, with wire-end ferrules and cross-section-optimized plastic collars (order no. 9203620000)

Type	current	Qty	Order No.
ZQV 6N/2		60	1906210000
ZQV 6N/3		60	1906220000
ZQV 6N/4		60	1906230000
ZQV 6N/20		20	1906240000
Width			
PAP PDU6/10	3 mm	20	1896330000
ZEW 35	6 mm	20	9540000000
SD 0.5x3.0x80		1	9008320000
PAD 6/10/4		80	1916160000

WS 10/8

Feed-through terminals

B

In hazardous area applications, the installation instructions and the rated data specifications for accessories given in the technical appendix must be followed.

Width/Length/height with TS35x7.5	mm
max. current / max. cond. cross-section	A/mm ²
Max. clamping range	mm ²

Technical data

Rated data	
Rated voltage	V
Rated current	A
Rated cross-section	mm ²
Rated impulse voltage / Pollution severity	kV/-
Gauge to IEC 60947-1 / UL94 Flammability class	
Approvals	
Clamped conductors (H05V/H07V)	
solid / stranded	mm ²
flexible / Stranded wire with end ferrules	mm ²
Twin wire-end ferrule	mm ²
Stripping length / Blade size	mm/-
Note	

Ordering data

Version	
	Dark beige Wemid
	Blue Wemid
Note	

Accessories

Pluggable cross-connection	
	2-pole
	3-pole
	4-pole
	10-pole
	20-/24-pole
End plate / partition	
	Dark beige Wemid
End bracket	
	Dark beige Wemid
Test adapter	
	Standard
	With assembly peg
Screwdriver	
	Standard
Reducing sleeves	
	For conductors < 0,5 mm ² / AWG 20
	For conductors < 1,0 mm ² / AWG 18
Cover	
	With lightning flash symbol
Marking systems	
	(see assortment in catalogue 7)
	Marking tags
For detailed information on other accessories and applications, refer to the „Accessories“ section	

PDU 6/10 3AN

10 mm²

3 connections



8.1 x 82.5 x 40	
/ 10	
1.5...10	

IEC 60947-7-1				Ex e ll II 2 G D			
IEC	UL	CSA	EN 60079-7	IEC	UL	CSA	EN 60079-7
800	600	600	550	800	600	600	550
57	44	44	37	76	76	76	59
10	AWG 16...8	AWG 16...8	6	16	AWG 12...5	AWG 12...5	16
				8 / 3			
				/ V-0			
Rated connection							
1.5...10							
1.5...10 / 1.5...10							
14 / 0.6 x 3.5 mm							
Note							

Type	Qty	Order No.
PDU 6/10/3AN	50	1896150000
PDU 6/10/3AN BL	50	1896280000
For use with 10 mm ² conductors, with wire-end ferrules and cross-section-optimized plastic collars (order no. 9203620000)		

Type	current	Qty	Order No.
ZQV 6N/2		60	1906210000
ZQV 6N/3		60	1906220000
ZQV 6N/4		60	1906230000
ZQV 6N/20		20	1906240000
Width			
PAP PDU6/10/3AN	3 mm	20	1896340000
ZEW 35	6 mm	20	9540000000
SD 0.5x3.0x80			
		1	9008320000
PAD 6/10/4			
		80	1916160000
WS 10/8			

PDU 16

16 mm²

2 connections

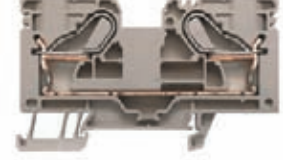

12.1 x 80.5 x 48	
/ 16	
2.5...16	

IEC 60947-7-1				Ex e ll II 2 G D			
IEC	UL	CSA	EN 60079-7	IEC	UL	CSA	EN 60079-7
800	600	600	550	800	600	600	550
76	76	76	59	76	76	76	59
16	AWG 12...5	AWG 12...5	16	16	AWG 12...5	AWG 12...5	16
				8 / 3			
				/ V-0			
Rated connection							
2.5...16							
2.5...16 / 2.5...16							
14 / 1.0 x 5.5 mm							
Note							

Type	Qty	Order No.
PDU 16	25	1896400000
PDU 16 BL	10	1896220000

Type	current	Qty	Order No.
ZQV 16/2	76 A	25	1739690000
PAP 16			
	3 mm	10	1896290000
ZEW 35			
	6 mm	20	9540000000
SD 1.0x5.5x150			
		1	9008350000
PAD 16/4			
		80	1916170000
WS 12/8			

PEI 16

16 mm²

Supply terminal

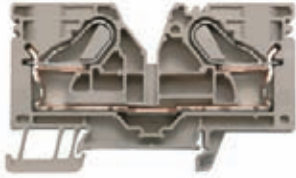

15 x 80.5 x 48

/ 16

2.5...16



Ex e II II 2 G D

IEC	UL	CSA	EN 60079-7
800	600	600	550
76	76	76	66
16	AWG 12...5	AWG 12...5	16
8 / 3			
/ V-0			



Rated connection

2.5...16

2.5...16 / 2.5...16

14 / 1.0 x 5.5 mm

Type	Qty	Order No.
PEI 16	25	1918780000
PEI 16 BL	25	1918790000

Terminal contains end plate.
No separate end plate is necessary.

Type	current	Qty	Order No.
ZQV 2.5/2	24 A	60	1608860000
ZQV 6N/3		60	1906220000

Width			
ZEW 35	6 mm	20	9540000000

SD 1.0x5.5x150	1	9008350000
----------------	---	------------

PAD 16/4	80	1916170000
----------	----	------------

WS 12/8

Modular PE terminals

B

In hazardous area applications, the installation instructions and the rated data specifications for accessories given in the technical appendix must be followed.

Width/Length/height with TS35x7.5	mm
max. current / max. cond. cross-section	A/mm ²
Max. clamping range	mm ²

Technical data

Rated data	
Rated cross-section	mm ²
Rated voltage to adjacent terminal	V
Rated impulse withstand voltage to adjacent terminal	kV
Short-time withstand current	
Pollution severity	
Gauge to IEC 60947-1 / UL94 Flammability class	
Approvals	
Clamped conductors (H05V/H07V)	
solid / stranded	mm ²
flexible / Stranded wire with end ferrules	mm ²
Twin wire-end ferrule	mm ²
Stripping length / Blade size	mm/-
Note	

Ordering data

Version
green/yellow Wemid
Note

Accessories

End plate / partition
Dark beige Wemid
End bracket
Dark beige Wemid
Screwdriver
Standard
Reducing sleeves
For conductors < 0,5 mm ² / AWG 20
For conductors < 1,0 mm ² / AWG 18
Cover
With lightning flash symbol



Marking systems (see assortment in catalogue 7)
 Marking tags
For detailed information on other accessories and applications, refer to the „Accessories“ section

PPE 2.5/4

4 mm²

2 connections



5.1 x 53 x 36
/ 6
0.13...6

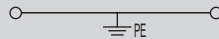

IEC 60947-7-2 Ex e ll II 2 G D

IEC	UL	CSA	EN 60079-7
4	AWG 26...10	AWG 26...10	AWG 26...10
800			
8			
	480 A (4 mm ²)		
	3		
	/ V-0		



Rated connection
0.5...6
0.5...4 / 0.5...4
0.5...2.5
12 / 3.0 x 0.5 mm
Note
4 mm ² conductor should be processed after crimping (according to Euro-Norm EN 60947-1), for example with PZ6/5, order no. 9011460000.

Type	Qty	Order No.
PPE 2.5/4	50	1896170000
For use with 4 mm ² conductors, with wire-end ferrules and cross-section-optimized plastic collars (order no. 9203630000)		

Type	Width	Qty	Order No.
PAP 2.5/4	3 mm	50	1896300000
ZEW 35	6 mm	20	9540000000
SD 0.5x3.0x80		1	9008320000
PRH 2.5/4/1		100	1916410000
PRH 2.5/4/2		100	1916400000
PAD 2.5/4/4		80	1916150000

DEK 5/5 / WS 10/5
 Detailed information for working with twin ferrules can be found in the P-Series Accessories section.

PPE 2.5/4 3AN

4 mm²

3 connections



5.1 x 67 x 36
/ 6
0.13...6

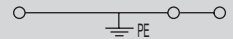

IEC 60947-7-2 Ex e ll II 2 G D

IEC	UL	CSA	EN 60079-7
4	AWG 26...10	AWG 26...10	AWG 26...10
800			
8			
	480 A (4 mm ²)		
	3		
	/ V-0		



Rated connection
0.5...6
0.5...4 / 0.5...4
0.5...2.5
12 / 3.0 x 0.5 mm
Note
4 mm ² conductor should be processed after crimping (according to Euro-Norm EN 60947-1), for example with PZ6/5, order no. 9011460000.

Type	Qty	Order No.
PPE 2.5/4/3AN	50	1896200000
For use with 4 mm ² conductors, with wire-end ferrules and cross-section-optimized plastic collars (order no. 9203630000)		

Type	Width	Qty	Order No.
PAP 2.5/4/3AN	3 mm	50	1896480000
ZEW 35	6 mm	20	9540000000
SD 0.5x3.0x80		1	9008320000
PRH 2.5/4/1		100	1916410000
PRH 2.5/4/2		100	1916400000
PAD 2.5/4/4		80	1916150000

DEK 5/5 / WS 10/5
 Detailed information for working with twin ferrules can be found in the P-Series Accessories section.

PPE 2.5/4 4AN

4 mm²

4 connections



5.1 x 80 x 36
/ 6
0.13...6



IEC 60947-7-2 Ex e II II 2 G D

IEC	UL	CSA	EN 60079-7
4	AWG 26...10	AWG 26...10	AWG 26...10
800			
8			
	480 A (4 mm ²)		
	3		
	/ V-0		



Rated connection

0.5...6
0.5...4 / 0.5...4
0.5...2.5
12 / 3.0 x 0.5 mm

4 mm² conductor should be processed after crimping (according to Euro-Norm EN 60947-1), for example with PZ6/5, order no. 9011460000.

Type	Qty	Order No.
PPE 2.5/4/4AN	50	1896160000

For use with 4 mm² conductors, with wire-end ferrules and cross-section-optimized plastic collars (order no. 9203630000)

Type	Width	Qty	Order No.
PAP 2.5/4/4AN	3 mm	50	1896320000
ZEW 35	6 mm	20	9540000000
SD 0.5x3.0x80		1	9008320000
PRH 2.5/4/1		100	1916410000
PRH 2.5/4/2		100	1916400000
PAD 2.5/4/4		80	1916150000

DEK 5/5 / WS 10/5

Detailed information for working with twin ferrules can be found in the P-Series Accessories section.

PPE 6/10

10 mm²

2 connections

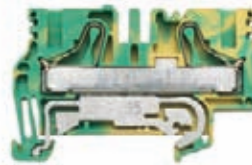

8.1 x 63.5 x 40
/ 10
1.5...10

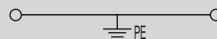

IEC 60947-7-2 Ex e II II 2 G D

IEC	UL	CSA	EN 60079-7
10	AWG 16...8	AWG 16...8	AWG 16...8
800			
8			
	1200 A (10 mm ²)		
	3		
	/ V-0		



Rated connection

1.5...10
1.5...10 / 1.5...10
14 / 0.6 x 3.5 mm

Type	Qty	Order No.
PPE 6/10	25	1896180000

For use with 10 mm² conductors, with wire-end ferrules and cross-section-optimized plastic collars (order no. 9203620000)

Type	Width	Qty	Order No.
PAP PDU6/10/3AN	3 mm	20	1896340000
ZEW 35	6 mm	20	9540000000
SD 0.5x3.0x80		1	9008320000
PAD 6/10/4		80	1916160000

WS 10/8

PPE 6/10 3AN

10 mm²

3 connections

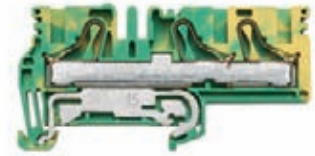

8.1 x 81.5 x 40
/ 10
1.5...10



IEC 60947-7-2 Ex e II II 2 G D

IEC	UL	CSA	EN 60079-7
10	AWG 16...8	AWG 16...8	AWG 16...8
800			
8			
	1200 A (10 mm ²)		
	3		
	/ V-0		



Rated connection

1.5...10
1.5...10 / 1.5...10
14 / 0.6 x 3.5 mm

Type	Qty	Order No.
PPE 6/10/3AN	25	1896190000

For use with 10 mm² conductors, with wire-end ferrules and cross-section-optimized plastic collars (order no. 9203620000)

Type	Width	Qty	Order No.
PAP PDU6/10/3AN	3 mm	20	1896340000
ZEW 35	6 mm	20	9540000000
SD 0.5x3.0x80		1	9008320000
PAD 6/10/4		80	1916160000

WS 10/8

Modular PE terminals

B

In hazardous area applications, the installation instructions and the rated data specifications for accessories given in the technical appendix must be followed.

Width/Length/height with TS35x7.5	mm
max. current / max. cond. cross-section	A/mm ²
Max. clamping range	mm ²

Technical data



Rated data	
Rated cross-section	mm ²
Rated voltage to adjacent terminal	V
Rated impulse withstand voltage to adjacent terminal	kV
Short-time withstand current	
Pollution severity	
Gauge to IEC 60947-1 / UL94 Flammability class	
Approvals	
Clamped conductors (H05V/H07V)	
solid / stranded	mm ²
flexible / Stranded wire with end ferrules	mm ²
Twin wire-end ferrule	mm ²
Stripping length / Blade size	mm/-

Note

Ordering data

Version	green/yellow Wemid
Note	

Accessories

Pluggable cross-connection	2-pole
	
End plate / partition	Dark beige Wemid
End bracket	Dark beige Wemid
Screwdriver	Standard
Cover	With lightning flash symbol
	

PPE 16

16 mm²

2 connections



12.1 x 81 x 48
/ 16
2.5...16

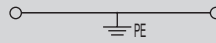

IEC 60947-7-2

Ex e ll  II 2 G D

IEC	UL	CSA	EN 60079-7
16	AWG 12...5	AWG 12...5	AWG 12...5
800			
8			
1920 A (16 mm ²)			
3			
/ V-0			



Rated connection

2.5...16
2.5...16 / 2.5...16
14 / 1.0 x 5.5 mm

Type	Qty	Order No.
PPE 16	10	1896210000

Type	current	Qty	Order No.
ZQV 16/2	76 A	25	1739690000
Width			
PAP 16	3 mm	10	1896290000
ZEW 35	6 mm	20	9540000000
SD 1.0x5.5x150		1	9008350000
PAD 16/4		80	1916170000

Marking systems (see assortment in catalogue 7)
Marking tags

For detailed information on other accessories and applications, refer to the „Accessories“ section

WS 10/12

PDK 2.5/4

2.5 mm²

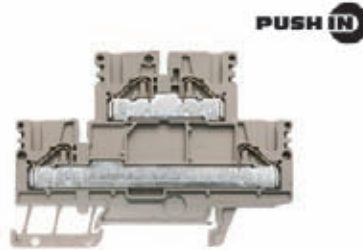

5.1 x 82.5 x 58
28 / 6
0.13...6

IEC 60947-7-1 Ex e II II 2 G D

IEC	UL	CSA
800	600	600
24		
2.5	AWG 26...10	AWG 26...10
8 / 3		
/ V-0		

Rated connection	
solid / stranded	mm ²
flexible / Stranded wire with end ferrules	mm ²
Twin wire-end ferrule	mm ²
Stripping length / Blade size	mm/-

4 mm² conductor should be processed after crimping (according to Euro-Norm EN 60947-1), for example with PZ6/5, order no. 9011460000.

PDK 2.5/4 V

2.5 mm²

Vertical cross-connected double-level terminal

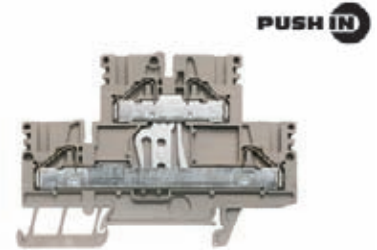

5.1 x 82.5 x 58
28 / 6
0.13...6

IEC 60947-7-1 Ex e II II 2 G D

IEC	UL	CSA
800	600	600
24		
2.5	AWG 26...10	AWG 26...10
8 / 3		
/ V-0		

Rated connection	
solid / stranded	mm ²
flexible / Stranded wire with end ferrules	mm ²
Twin wire-end ferrule	mm ²
Stripping length / Blade size	mm/-

4 mm² conductor should be processed after crimping (according to Euro-Norm EN 60947-1), for example with PZ6/5, order no. 9011460000.

In hazardous area applications, the installation instructions and the rated data specifications for accessories given in the technical appendix must be followed.

Width/Length/height with TS35x7.5 mm
 max. current / max. cond. cross-section A/mm²
 Max. clamping range mm²

Technical data

Rated data	
Rated voltage	V
Rated current	A
Rated cross-section	mm ²
Rated impulse voltage / Pollution severity	kV/-
Gauge to IEC 60947-1 / UL94 Flammability class	
Approvals	
Clamped conductors (H05V/H07V)	
solid / stranded	mm ²
flexible / Stranded wire with end ferrules	mm ²
Twin wire-end ferrule	mm ²
Stripping length / Blade size	mm/-
Note	

Ordering data

Version	
	Dark beige Wemid
	Blue Wemid
Note	

Accessories

Pluggable cross-connection	
	2-pole
	3-pole
	4-pole
	10-pole
	20-/24-pole
End plate / partition	
	Dark beige Wemid
End bracket	
	Dark beige Wemid
Screwdriver	
	Standard
Reducing sleeves	
	For conductors < 0,5 mm ² / AWG 20
	For conductors < 1,0 mm ² / AWG 18
Cover	
	With lightning flash symbol

Type	Qty	Order No.
PDK 2.5/4	50	1918770000
PDK 2.5/4 BL	50	1918760000

For use with 4 mm² conductors, with wire-end ferrules and cross-section-optimized plastic collars (order no. 9203630000)

Type	current	Qty	Order No.
ZQV 2.5/2	24 A	60	1608860000
ZQV 2.5/3	24 A	60	1608870000
ZQV 2.5/4	24 A	60	1608880000
ZQV 2.5/10	24 A	20	1608940000
ZQV 2.5/20	24 A	20	1908960000
Width			
PAP PDK 2.5/4	3 mm	20	1919720000
ZEW 35	6 mm	20	9540000000
Width			
SD 0.5x3.0x80		1	9008320000
PRH 2.5/4/1		100	1916410000
PRH 2.5/4/2		100	1916400000
PAD 2.5/4/4		80	1916150000

Type	Qty	Order No.
PDK 2.5/4V	50	1918730000
PDK 2.5/4V BL	50	1918680000

For use with 4 mm² conductors, with wire-end ferrules and cross-section-optimized plastic collars (order no. 9203630000)

Type	current	Qty	Order No.
ZQV 2.5/2	24 A	60	1608860000
ZQV 2.5/3	24 A	60	1608870000
ZQV 2.5/4	24 A	60	1608880000
ZQV 2.5/10	24 A	20	1608940000
ZQV 2.5/20	24 A	20	1908960000
Width			
PAP PDK 2.5/4	3 mm	20	1919720000
ZEW 35	6 mm	20	9540000000
Width			
SD 0.5x3.0x80		1	9008320000
PRH 2.5/4/1		100	1916410000
PRH 2.5/4/2		100	1916400000
PAD 2.5/4/4		80	1916150000

Marking systems (see assortment in catalogue 7)
 DEK 5/5 / Snap Mark
For detailed information on other accessories and applications, refer to the „Accessories“ section

DEK 5/5 / Snap Mark
 Detailed information for working with twin ferrules can be found in the P Series Accessories section.

DEK 5/5 / Snap Mark
 Detailed information for working with twin ferrules can be found in the P Series Accessories section.

Double level terminals

B

In hazardous area applications, the installation instructions and the rated data specifications for accessories given in the technical appendix must be followed.

Width/Length/height with TS35x7.5	mm
max. current / max. cond. cross-section	A/mm ²
Max. clamping range	mm ²

Technical data

Rated data	
Rated voltage	V
Rated current	A
Rated cross-section	mm ²
Rated impulse voltage / Pollution severity	kV/-
Gauge to IEC 60947-1 / UL94 Flammability class	
Approvals	
Clamped conductors (H05V/H07V)	
solid / stranded	mm ²
flexible / Stranded wire with end ferrules	mm ²
Twin wire-end ferrule	mm ²
Stripping length / Blade size	mm/-
Note	

Ordering data

Version	
	Dark beige Wemid
	Blue Wemid
Note	

Accessories

Pluggable cross-connection	
	2-pole
	3-pole
	4-pole
	10-pole
	20-/24-pole
End plate / partition	
	Dark beige Wemid
End bracket	
	Dark beige Wemid
Screwdriver	
	Standard
Reducing sleeves	
	For conductors < 0,5 mm ² / AWG 20
	For conductors < 1,0 mm ² / AWG 18
Cover	
	With lightning flash symbol

Marking systems	
	(see assortment in catalogue 7)
	DEK 5/5 / Snap Mark
For detailed information on other accessories and applications, refer to the „Accessories“ section	

PDK 2.5/4 N-L

2.5 mm²

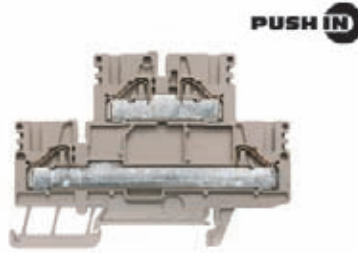

5.1 x 82.5 x 58	
28 / 6	
0.13...6	

IEC 60947-7-1	Ex e ll	Ex	ll 2 G D
IEC	UL	CSA	
800	600	600	
24			
2.5	AWG 26...10	AWG 26...10	
		8 / 3	
		/ V-0	
Rated connection			
0.5...6			
0.5...4 / 0.5...4			
0.5...2.5			
12 / 3.0 x 0.5 mm			
4 mm ² conductor should be processed after crimping (according to Euro-Norm EN 60947-1), for example with PZ6/5, order no. 9011460000.			

Type	Qty	Order No.
PDK 2.5/4N/L	50	1918740000
For use with 4 mm ² conductors, with wire-end ferrules and cross-section-optimized plastic collars (order no. 9203630000)		

Type	current	Qty	Order No.
ZQV 2.5/2	24 A	60	1608860000
ZQV 2.5/3	24 A	60	1608870000
ZQV 2.5/4	24 A	60	1608880000
ZQV 2.5/10	24 A	20	1608940000
ZQV 2.5/20	24 A	20	1908960000
Width			
PAP PDK 2.5/4	3 mm	20	1919720000
ZEW 35	6 mm	20	9540000000
SD 0.5x3.0x80		1	9008320000
PRH 2.5/4/1		100	1916410000
PRH 2.5/4/2		100	1916400000
PAD 2.5/4/4		80	1916150000

Marking systems	
	DEK 5/5 / Snap Mark
For detailed information on other accessories and applications, refer to the „Accessories“ section.	

PDK 2.5/4 L-PE

2.5 mm²

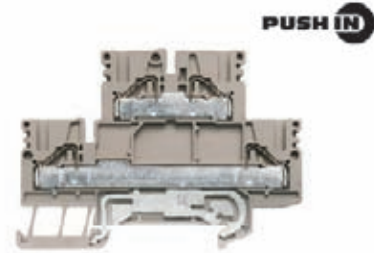

5.1 x 82.5 x 58	
28 / 6	
0.13...6	

IEC 60947-7-1	Ex e ll	Ex	ll 2 G D
IEC	UL	CSA	
800	600	600	
24			
2.5	AWG 26...10	AWG 26...10	
		8 / 3	
		/ V-0	
Rated connection			
0.5...6			
0.5...4 / 0.5...4			
0.5...2.5			
12 / 3.0 x 0.5 mm			
4 mm ² conductor should be processed after crimping (according to Euro-Norm EN 60947-1), for example with PZ6/5, order no. 9011460000.			

Type	Qty	Order No.
PDK 2.5/4L-PE	50	1918720000
For use with 4 mm ² conductors, with wire-end ferrules and cross-section-optimized plastic collars (order no. 9203630000)		

Type	current	Qty	Order No.
ZQV 2.5/2	24 A	60	1608860000
ZQV 2.5/3	24 A	60	1608870000
ZQV 2.5/4	24 A	60	1608880000
ZQV 2.5/10	24 A	20	1608940000
ZQV 2.5/20	24 A	20	1908960000
Width			
PAP PDK 2.5/4	3 mm	20	1919720000
ZEW 35	6 mm	20	9540000000
SD 0.5x3.0x80		1	9008320000
PRH 2.5/4/1		100	1916410000
PRH 2.5/4/2		100	1916400000
PAD 2.5/4/4		80	1916150000

Marking systems	
	DEK 5/5 / Snap Mark
For detailed information on other accessories and applications, refer to the „Accessories“ section.	

PDK 2.5/4 PE

4 mm²

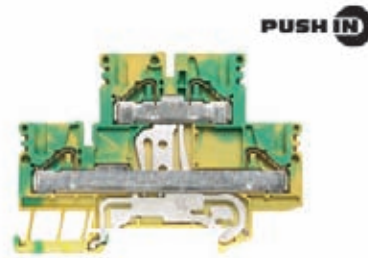

In hazardous area applications, the installation instructions and the rated data specifications for accessories given in the technical appendix must be followed.

Width/Length/height with TS35x7.5	mm
max. current / max. cond. cross-section	A/mm ²
Max. clamping range	mm ²

5.1 x 82.5 x 58	
/ 6	
0.13...6	

Technical data

Rated data	
Rated cross-section	mm ²
Rated voltage to adjacent terminal	V
Rated impulse withstand voltage to adjacent terminal	kV
Short-time withstand current	
Pollution severity	
Gauge to IEC 60947-1 / UL94 Flammability class	
Approvals	
Clamped conductors (H05V/H07V)	
solid / stranded	mm ²
flexible / Stranded wire with end ferrules	mm ²
Twin wire-end ferrule	mm ²
Blade size	-
Note	

IEC 60947-7-2 Ex e ll II 2 G D

IEC	UL	CSA
4	AWG 26...10	AWG 26...10
800		
8		
	480 A (4 mm ²)	
	3	
	/ V-0	

Rated connection

0.5...6
0.5...4 / 0.5...4
0.5...2.5

4 mm² conductor should be processed after crimping (according to Euro-Norm EN 60947-1), for example with PZ6/5, order no. 9011460000.

Ordering data

Version	green/yellow Wemid
Note	

Type	Qty	Order No.
PDK 2.5/4 PE	50	1918710000

For use with 4 mm² conductors, with wire-end ferrules and cross-section-optimized plastic collars (order no. 9203630000)

Accessories

End plate / partition	Dark beige Wemid
End bracket	Dark beige Wemid
Screwdriver	Standard
Reducing sleeves	For conductors < 0,5 mm ² / AWG 20 For conductors < 1,0 mm ² / AWG 18
Cover	With lightning flash symbol

Type	Width	Qty	Order No.
PAP PDK 2.5/4	3 mm	20	1919720000
ZEW 35	6 mm	20	9540000000
SD 0.5x3.0x80		1	9008320000
PRH 2.5/4/1		100	1916410000
PRH 2.5/4/2		100	1916400000
PAD 2.5/4/4		80	1916150000

Marking systems (see assortment in catalogue 7)
Marking tags
For detailed information on other accessories and applications, refer to the „Accessories“ section

DEK 5/5 / WS 10/5
Detailed information for working with twin ferrules can be found in the P-Series Accessories section.

Test-disconnect terminals

B

In hazardous area applications, the installation instructions and the rated data specifications for accessories given in the technical appendix must be followed.

Width/Length/height with TS35x7.5	mm
max. current / max. cond. cross-section	A/mm ²
Max. clamping range	mm ²

Technical data

Rated data	
Rated voltage of feed-through terminal	V
Rated current	A
Rated cross-section	mm ²
Rated impulse voltage / Pollution severity	kV/-
Gauge to IEC 60947-1 / UL94 Flammability class	
Approvals	
Clamped conductors (H05V/H07V)	
solid / stranded	mm ²
flexible / Stranded wire with end ferrules	mm ²
Twin wire-end ferrule	mm ²
Stripping length / Blade size	mm/-
Note	

Ordering data

Version	
	Dark beige Wemid
	Blue Wemid
	Without isolator, Dark beige Wemid
Note	

Accessories

Pluggable cross-connection	
	2-pole
	3-pole
	4-pole
	10-pole
	20-/24-pole
End plate / partition	
	Dark beige Wemid
End bracket	
	Dark beige Wemid
Screwdriver	
	Standard
Testing / Checking	
	Test plug
Holder for cartridge fuse, 5 x 20mm	
	400 V AC/DC, without LED
	10 - 36 V AC/DC, red LED
	140 - 250 V AC/DC, red LED
Module connector (max, 250 V)	
	without fittings
	with wire jumper
	With 1N4007 diode
Disconnect plug	
	yellow Wemid
Marking systems	
	(see assortment in catalogue 7)
	Marking tags
For detailed information on other accessories and applications, refer to the „Accessories“ section	

PTR 2.5/4

2.5 mm²

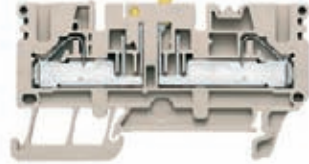

5.1 x 71 x 39.5	
22 / 6	
0.13...6	

IEC 60947-7-1		
IEC	UL	CSA
500	300	300
22	10	10
2.5	AWG 26...10	AWG 26...10
6 / 3		
A3 / V-0		
UL		
Rated connection		
0.5...6		
0.5...4 / 0.5...4		
0.5...2.5		
12 / 0.6 x 3.5 mm		
PTR has two contact possibilities for the PS 2.3; 4 mm ² conductor should be processed after crimping (according to EN 60947-1), for example with		

Type	Qty	Order No.
PTR 2.5/4	50	1933950000
PTR 2.5/4 BL	50	1933970000
For use with 4 mm ² conductors, with wire-end ferrules and cross-section-optimized plastic collars (order no. 9203630000)		

Type	current	Qty	Order No.
ZQV 2.5/2	24 A	60	1608860000
ZQV 2.5/3	24 A	60	1608870000
ZQV 2.5/4	24 A	60	1608880000
ZQV 2.5/10	24 A	20	1608940000
ZQV 2.5/20	24 A	20	1908960000
Width			
PAP PTR2.5/4	3 mm	20	1934680000
ZEW 35	6 mm	20	9540000000
SD 0.5x3.0x80		1	9008320000
PS 2.3 RT	5.4 mm	20	0180400000
SIHA 3/G20	6 mm	25	7921560000
SIHA 3/G20/LD 10-36V	6 mm	25	7921570000
SIHA 3/G20/LD 140-250V	6 mm	25	7921600000
BEST	5.1 mm	50	1833100000
BEST/DRBR	5.1 mm	50	1878570000
BEST/D	5.1 mm	50	1878560000
TNST		50	1833090000

DEK 5/5 / WS 10/5	Detailed information for working with twin ferrules can be found in the P Series Accessories section.
-------------------	---

PTR 2.5/4 O TNHE

2.5 mm²

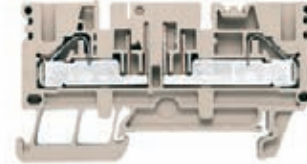

5.1 x 71 x 39.5	
22 / 6	
0.13...6	

IEC 60947-7-1		
IEC	UL	CSA
500	300	300
22	10	10
2.5	AWG 26...10	AWG 26...10
6 / 3		
A3 / V-0		
UL		
Rated connection		
0.5...6		
0.5...4 / 0.5...4		
0.5...2.5		
12 / 0.6 x 3.5 mm		
PTR has two contact possibilities for the PS 2.3; 4 mm ² conductor should be processed after crimping (according to EN 60947-1), for example with		

Type	Qty	Order No.
PTR 2.5/4 O TNHE	50	1933910000
For use with 4 mm ² conductors, with wire-end ferrules and cross-section-optimized plastic collars (order no. 9203630000)		

Type	current	Qty	Order No.
ZQV 2.5/2	24 A	60	1608860000
ZQV 2.5/3	24 A	60	1608870000
ZQV 2.5/4	24 A	60	1608880000
ZQV 2.5/10	24 A	20	1608940000
ZQV 2.5/20	24 A	20	1908960000
Width			
PAP PTR2.5/4	3 mm	20	1934680000
ZEW 35	6 mm	20	9540000000
SD 0.5x3.0x80		1	9008320000
PS 2.3 RT	5.4 mm	20	0180400000
SIHA 3/G20	6 mm	25	7921560000
SIHA 3/G20/LD 10-36V	6 mm	25	7921570000
SIHA 3/G20/LD 140-250V	6 mm	25	7921600000
BEST	5.1 mm	50	1833100000
BEST/DRBR	5.1 mm	50	1878570000
BEST/D	5.1 mm	50	1878560000
TNST		50	1833090000

DEK 5/5 / WS 10/5	Detailed information for working with twin ferrules can be found in the P Series Accessories section.
-------------------	---

PTR 2.5/4 3AN

2.5 mm²

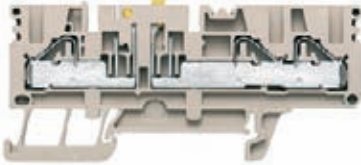

5.1 x 85 x 39.5
22 / 6
0.13...6

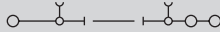

IEC 60947-7-1

IEC	UL	CSA
500	300	300
22	10	10
2.5	AWG 26...10	AWG 26...10
6 / 3		
A3 / V-0		



Rated connection

0.5...6
0.5...4 / 0.5...4
0.5...2.5
12 / 0.6 x 3.5 mm

Contact can be applied to the PTR with the PS 2.3; process 4-mm² conductors with crimp, acc. to Euro-Norm EN 60947-1, for example with PZ6/5, order no. 9011460000

Type	Qty	Order No.
PTR 2.5/4/3AN	50	1933980000
PTR 2.5/4/3AN BL	50	1933930000

For use with 4 mm² conductors, with wire-end ferrules and cross-section-optimized plastic collars (order no. 9203630000)

Type	current	Qty	Order No.
ZQV 2.5/2	24 A	60	1608860000
ZQV 2.5/3	24 A	60	1608870000
ZQV 2.5/4	24 A	60	1608880000
ZQV 2.5/10	24 A	20	1608940000
ZQV 2.5/20	24 A	20	1908960000
Width			
PAP PTR2.5/4/3AN	3 mm	20	1934690000
ZEW 35	6 mm	20	9540000000
SD 0.5x3.0x80		1	9008320000
PS 2.3 RT	5.4 mm	20	0180400000
SIHA 3/G20	6 mm	25	7921560000
SIHA 3/G20/LD 10-36V	6 mm	25	7921570000
SIHA 3/G20/LD 140-250V	6 mm	25	7921600000
BEST	5.1 mm	50	1833100000
BEST/DRBR	5.1 mm	50	1878570000
BEST/D	5.1 mm	50	1878560000
TNST		50	1833090000

DEK 5/5 / WS 10/5

Detailed information for working with twin ferrules can be found in the P Series Accessories section.

PTR 2.5/4 3AN O TNHE

2.5 mm²

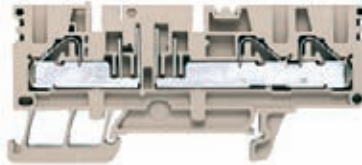

5.1 x 85 x 39.5
22 / 6
0.13...6

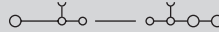

IEC 60947-7-1

IEC	UL	CSA
500	300	300
22	10	10
2.5	AWG 26...10	AWG 26...10
6 / 3		
A3 / V-0		



Rated connection

0.5...6
0.5...4 / 0.5...4
0.5...2.5
12 / 0.6 x 3.5 mm

Contact can be applied to the PTR with the PS 2.3; process 4-mm² conductors with crimp, acc. to Euro-Norm EN 60947-1, for example with PZ6/5, order no. 9011460000

Type	Qty	Order No.
PTR 2.5/4/3AN O TNHE	50	1933990000

For use with 4 mm² conductors, with wire-end ferrules and cross-section-optimized plastic collars (order no. 9203630000)

Type	current	Qty	Order No.
ZQV 2.5/2	24 A	60	1608860000
ZQV 2.5/3	24 A	60	1608870000
ZQV 2.5/4	24 A	60	1608880000
ZQV 2.5/10	24 A	20	1608940000
ZQV 2.5/20	24 A	20	1908960000
Width			
PAP PTR2.5/4/3AN	3 mm	20	1934690000
ZEW 35	6 mm	20	9540000000
SD 0.5x3.0x80		1	9008320000
PS 2.3 RT	5.4 mm	20	0180400000
SIHA 3/G20	6 mm	25	7921560000
SIHA 3/G20/LD 10-36V	6 mm	25	7921570000
SIHA 3/G20/LD 140-250V	6 mm	25	7921600000
BEST	5.1 mm	50	1833100000
BEST/DRBR	5.1 mm	50	1878570000
BEST/D	5.1 mm	50	1878560000
TNST		50	1833090000

DEK 5/5 / WS 10/5

Detailed information for working with twin ferrules can be found in the P Series Accessories section.

PTR 2.5/4 4AN

2.5 mm²

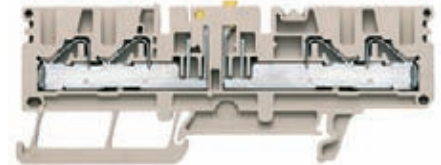

5.1 x 99 x 39.5
22 / 6
0.13...6

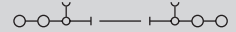

IEC 60947-7-1

IEC	UL	CSA
500	300	300
22	10	10
2.5	AWG 26...10	AWG 26...10
6 / 3		
A3 / V-0		



Rated connection

0.5...6
0.5...4 / 0.5...4
0.5...2.5
12 / 0.6 x 3.5 mm

PTR can be connected with the PS 2.3; 4 mm² conductor should be processed after crimping (according to EN 60947-1), for example with PZ6/5, order no. 9011460000

Type	Qty	Order No.
PTR 2.5/4/4AN	50	1933940000
PTR 2.5/4/4AN BL	50	1934000000

For use with 4 mm² conductors, with wire-end ferrules and cross-section-optimized plastic collars (order no. 9203630000)

Type	current	Qty	Order No.
ZQV 2.5/2	24 A	60	1608860000
ZQV 2.5/3	24 A	60	1608870000
ZQV 2.5/4	24 A	60	1608880000
ZQV 2.5/10	24 A	20	1608940000
ZQV 2.5/20	24 A	20	1908960000
Width			
PAP PTR2.5/4/4AN	3 mm	20	1934700000
ZEW 35	6 mm	20	9540000000
SD 0.5x3.0x80		1	9008320000
PS 2.3 RT	5.4 mm	20	0180400000
SIHA 3/G20	6 mm	25	7921560000
SIHA 3/G20/LD 10-36V	6 mm	25	7921570000
SIHA 3/G20/LD 140-250V	6 mm	25	7921600000
BEST	5.1 mm	50	1833100000
BEST/DRBR	5.1 mm	50	1878570000
BEST/D	5.1 mm	50	1878560000
TNST		50	1833090000

DEK 5/5 / WS 10/5

Detailed information for working with twin ferrules can be found in the P Series Accessories section.

Test-disconnect terminals

In hazardous area applications, the installation instructions and the rated data specifications for accessories given in the technical appendix must be followed.

Width/Length/height with TS35x7.5	mm
max. current / max. cond. cross-section	A/mm ²
Max. clamping range	mm ²

Technical data

Rated data	
Rated voltage of feed-through terminal	V
Rated current	A
Rated cross-section	mm ²
Rated impulse voltage / Pollution severity	kV/-
Gauge to IEC 60947-1 / UL94 Flammability class	
Approvals	

Clamped conductors (H05V/H07V)

solid / stranded	mm ²
flexible / Stranded wire with end ferrules	mm ²
Twin wire-end ferrule	mm ²
Stripping length / Blade size	mm/-

Note

Ordering data

Version	
	Dark beige Wemid
	Blue Wemid
	Without isolator, Dark beige Wemid
Note	

Accessories

Pluggable cross-connection	
	2-pole
	3-pole
	4-pole
	10-pole
	20-/24-pole
End plate / partition	
	Dark beige Wemid
End bracket	
	Dark beige Wemid
Screwdriver	
	Standard
Testing / Checking	
	Test plug
Holder for cartridge fuse, 5 x 20mm	
	400 V AC/DC, without LED
	10 - 36 V AC/DC, red LED
	140 - 250 V AC/DC, red LED
Module connector (max, 250 V)	
	without fittings
	with wire jumper
	With 1N4007 diode
Disconnect plug	
	yellow Wemid

Marking systems	
	(see assortment in catalogue 7)
	Marking tags

For detailed information on other accessories and applications, refer to the „Accessories“ section

PTR 2.5/4 4AN O TNHE

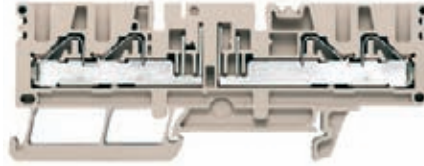
2.5 mm²

5.1 x 99 x 39.5

22 / 6

0.13...6

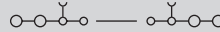

IEC 60947-7-1

IEC	UL	CSA
500	300	300
22	10	10
2.5	AWG 26...10	AWG 26...10
	6 / 3	
	A3 / V-0	



Rated connection

0.5...6
0.5...4 / 0.5...4
0.5...2.5
12 / 0.6 x 3.5 mm

PTR can be connected with the PS 2.3; 4 mm² conductor should be processed after crimping (according to EN 60947-1), for example with PZB/5, order no. 9011460000

Type	Qty	Order No.
PTR 2.5/4/4AN O TNHE	50	1933890000

For use with 4 mm² conductors, with wire-end ferrules and cross-section-optimized plastic collars (order no. 9203630000)

Type	current	Qty	Order No.
ZQV 2.5/2	24 A	60	1608860000
ZQV 2.5/3	24 A	60	1608870000
ZQV 2.5/4	24 A	60	1608880000
ZQV 2.5/10	24 A	20	1608940000
ZQV 2.5/20	24 A	20	1908960000
Width			
PAP PTR2.5/4/4AN	3 mm	20	1934700000
ZEW 35	6 mm	20	9540000000
SD 0.5x3.0x80		1	9008320000
PS 2.3 RT	5.4 mm	20	0180400000
SIHA 3/G20	6 mm	25	7921560000
SIHA 3/G20/LD 10-36V	6 mm	25	7921570000
SIHA 3/G20/LD 140-250V	6 mm	25	7921600000
BEST	5.1 mm	50	1833100000
BEST/DRBR	5.1 mm	50	1878570000
BEST/D	5.1 mm	50	1878560000
TNST		50	1833090000

DEK 5/5 / WS 10/5

Detailed information for working with twin ferrules can be found in the P Series Accessories section.

PDL 4/TR/DU O TNHE

4 mm²

PDL 4/TR/DU/PE O TNHE

4 mm²

In hazardous area applications, the installation instructions and the rated data specifications for accessories given in the technical appendix must be followed.

Width/Length/height with TS35x7.5	mm
max. current / max. cond. cross-section	A/mm ²
Max. clamping range	mm ²

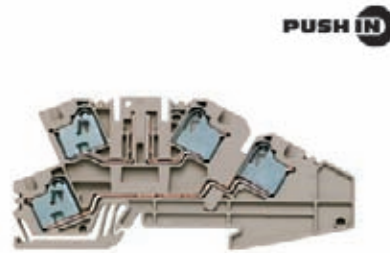

5.1 x 100 x 48.5	
/ 6	
0.08...6	

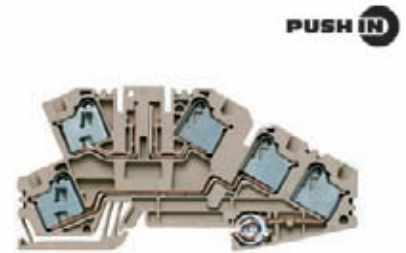

5.1 x 100 x 48.5	
/ 6	
0.08...6	

Technical data

Rated data	
Rated voltage of feed-through terminal	V
Rated current	A
Rated cross-section	mm ²
Rated impulse voltage / Pollution severity	kV/-
Gauge to IEC 60947-1 / UL94 Flammability class	
Approvals	
Clamped conductors (H05V/H07V)	
solid / stranded	mm ²
flexible / Stranded wire with end ferrules	mm ²
Twin wire-end ferrule	mm ²
Stripping length / Blade size	mm/-
Note	

IEC 60947-7-1

IEC	UL	CSA
400	300	300
20	10	10
4	AWG 28...10	AWG 28...10
4 / 3		
/ V-0		

Rated connection

0.5...6
0.5...4 / 0.5...4
0.5...1.5
12 / 3.0 x 0.5 mm

30A bottom level
20A top level

IEC 60947-7-1 (-7-2)

IEC	UL	CSA
400	300	300
20	10	10
4	AWG 28...10	AWG 28...10
4 / 3		
/ V-0		

Rated connection

0.5...6
0.5...4 / 0.5...4
0.5...1.5
12 / 3.0 x 0.5 mm

30A bottom level
20A top level

Ordering data

Version	Dark beige Wemid Without isolator, Dark beige Wemid
Note	

Type	Qty	Order No.
PDL 4/TR/DU O TNHE	50	1899210000
... without isolating lever. Suitable for the SIHA 3 fuse holder with G-fuse, for the BEST component plug and for the TNST isolating plug .		

Type	Qty	Order No.
PDL 4/TR/DU/PE O TNHE	50	1899220000
... without isolating lever. Suitable for the SIHA 3 fuse holder with G-fuse, for the BEST component plug and for the TNST isolating plug .		

Accessories

Pluggable cross-connection	
	2-pole
	3-pole
	4-pole
	10-pole
	20-/24-pole
End plate / partition	
	Dark beige Wemid
End bracket	
	Dark beige Wemid
Screwdriver	
	Standard
Holder for cartridge fuse, 5 x 20mm	
	400 V AC/DC, without LED
	10 - 36 V AC/DC, red LED
	140 - 250 V AC/DC, red LED
Module connector (max, 250 V)	
	without fittings
	with wire jumper
	With 1N4007 diode
Disconnect plug	
	yellow Wemid

Type	current	Qty	Order No.
ZQV 2.5/2	24 A	60	1608860000
ZQV 2.5/3	24 A	60	1608870000
ZQV 2.5/4	24 A	60	1608880000
ZQV 2.5/10	24 A	20	1608940000
ZQV 2.5/20	24 A	20	1908960000
Width			
PAP PDL4	3 mm	20	1883210000
ZEW 35	6 mm	20	9540000000
SD 0.5x3.0x80			
		1	9008320000
SIHA 3/G20			
SIHA 3/G20	6 mm	25	7921560000
SIHA 3/G20/LD 10-36V	6 mm	25	7921570000
SIHA 3/G20/LD 140-250V	6 mm	25	7921600000
BEST			
BEST	5.1 mm	50	1833100000
BEST/DRBR	5.1 mm	50	1878570000
BEST/D	5.1 mm	50	1878560000
TNST			
TNST		50	1833090000

Type	current	Qty	Order No.
ZQV 2.5/2	24 A	60	1608860000
ZQV 2.5/3	24 A	60	1608870000
ZQV 2.5/4	24 A	60	1608880000
ZQV 2.5/10	24 A	20	1608940000
ZQV 2.5/20	24 A	20	1908960000
Width			
PAP PDL4	3 mm	20	1883210000
ZEW 35	6 mm	20	9540000000
SD 0.5x3.0x80			
		1	9008320000
SIHA 3/G20			
SIHA 3/G20	6 mm	25	7921560000
SIHA 3/G20/LD 10-36V	6 mm	25	7921570000
SIHA 3/G20/LD 140-250V	6 mm	25	7921600000
BEST			
BEST	5.1 mm	50	1833100000
BEST/DRBR	5.1 mm	50	1878570000
BEST/D	5.1 mm	50	1878560000
TNST			
TNST		50	1833090000

Marking systems	(see assortment in catalogue 7) Marking tags
For detailed information on other accessories and applications, refer to the „Accessories“ section	

DEK 5/5 / WS 10/5	Detailed information for working with twin ferrules can be found in the P Series Accessories section.
-------------------	---

DEK 5/5 / WS 10/5	Detailed information for working with twin ferrules can be found in the P Series Accessories section.
-------------------	---

Test-disconnect terminals

In hazardous area applications, the installation instructions and the rated data specifications for accessories given in the technical appendix must be followed.

Width/Length/height with TS35x7.5	mm
max. current / max. cond. cross-section	A/mm ²
Max. clamping range	mm ²

Technical data

Rated data	
Rated voltage of feed-through terminal	V
Rated current	A
Rated cross-section	mm ²
Rated impulse voltage / Pollution severity	kV/-
Gauge to IEC 60947-1 / UL94 Flammability class	
Approvals	

Clamped conductors (H05V/H07V)

solid / stranded	mm ²
flexible / Stranded wire with end ferrules	mm ²
Twin wire-end ferrule	mm ²
Stripping length / Blade size	mm/-

Note

Ordering data

Version	Dark beige Wemid Without isolator, Dark beige Wemid
Note	

Accessories

Pluggable cross-connection	
	2-pole
	3-pole
	4-pole
	10-pole
	20-/24-pole
End plate / partition	
	Dark beige Wemid
End bracket	
	Dark beige Wemid
Screwdriver	
	Standard
Holder for cartridge fuse, 5 x 20mm	
	400 V AC/DC, without LED
	10 - 36 V AC/DC, red LED
	140 - 250 V AC/DC, red LED
Module connector (max. 250 V)	
	without fittings
	with wire jumper
	With 1N4007 diode
Disconnect plug	
	yellow Wemid

Marking systems (see assortment in catalogue 7)

Marking tags

For detailed information on other accessories and applications, refer to the „Accessories“ section

PDL 4/TR/DU

4 mm²

With isolator

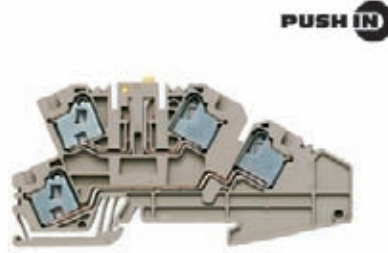

5.1 x 100 x 48.5

/ 6

0.08...6

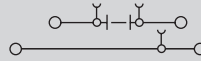

IEC 60947-7-1

IEC	UL	CSA
400	300	300
20	10	10
4	AWG 28...10	AWG 28...10
		4 / 3
		/ V-0

.9L

Rated connection

0.5...6
0.5...4 / 0.5...4
0.5...1.5
12 / 3.0 x 0.5 mm

30A bottom level
20A top level

Type	Qty	Order No.
PDL 4/TR/DU	50	1899190000
Without isolator: PDL 4 TR/DU O TNHE Order no.: 1899210000		

Type	current	Qty	Order No.
ZQV 2.5/2	24 A	60	1608860000
ZQV 2.5/3	24 A	60	1608870000
ZQV 2.5/4	24 A	60	1608880000
ZQV 2.5/10	24 A	20	1608940000
ZQV 2.5/20	24 A	20	1908960000
Width			
PAP PDL4	3 mm	20	1883210000
ZEW 35	6 mm	20	9540000000
SD 0.5x3.0x80		1	9008320000
SIHA 3/G20	6 mm	25	7921560000
SIHA 3/G20/LD 10-36V	6 mm	25	7921570000
SIHA 3/G20/LD 140-250V	6 mm	25	7921600000
BEST	5.1 mm	50	1833100000
BEST/DRBR	5.1 mm	50	1878570000
BEST/D	5.1 mm	50	1878560000
TNST		50	1833090000

DEK 5/5 / WS 10/5

Detailed information for working with twin ferrules can be found in the P Series Accessories section.

PDL 4/TR/DU/PE

4 mm²

With isolator

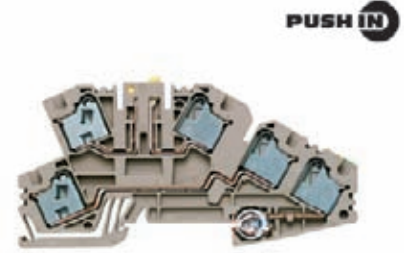

5.1 x 100 x 48.5

/ 6

0.08...6

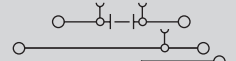

IEC 60947-7-1 (-7-2)

IEC	UL	CSA
400	300	300
20	10	10
4	AWG 28...10	AWG 28...10
		4 / 3
		/ V-0

.9L

Rated connection

0.5...6
0.5...4 / 0.5...4
0.5...1.5
12 / 3.0 x 0.5 mm

30A bottom level
20A top level

Type	Qty	Order No.
PDL 4/TR/DU/PE	50	1899200000
Without isolator: PDL 4 TR/DU/PE O TNHE Order no.: 1899220000		

Type	current	Qty	Order No.
ZQV 2.5/2	24 A	60	1608860000
ZQV 2.5/3	24 A	60	1608870000
ZQV 2.5/4	24 A	60	1608880000
ZQV 2.5/10	24 A	20	1608940000
ZQV 2.5/20	24 A	20	1908960000
Width			
PAP PDL4	3 mm	20	1883210000
ZEW 35	6 mm	20	9540000000
SD 0.5x3.0x80		1	9008320000
SIHA 3/G20	6 mm	25	7921560000
SIHA 3/G20/LD 10-36V	6 mm	25	7921570000
SIHA 3/G20/LD 140-250V	6 mm	25	7921600000
BEST	5.1 mm	50	1833100000
BEST/DRBR	5.1 mm	50	1878570000
BEST/D	5.1 mm	50	1878560000
TNST		50	1833090000

DEK 5/5 / WS 10/5

Detailed information for working with twin ferrules can be found in the P Series Accessories section.

Neutral conductor disconnect terminals

In hazardous area applications, the installation instructions and the rated data specifications for accessories given in the technical appendix must be followed.

Width/Length/height with TS35x7.5	mm
max. current / max. cond. cross-section	A/mm ²
Max. clamping range	mm ²



Technical data

Rated data	
Rated voltage	V
Rated current	A
Rated cross-section	mm ²
Rated impulse voltage / Pollution severity	kV/-
Gauge to IEC 60947-1 / UL94 Flammability class	
Approvals	
Clamped conductors (H05V/H07V)	
solid / stranded	mm ²
flexible / Stranded wire with end ferrules	mm ²
Twin wire-end ferrule	mm ²
Stripping length / Blade size	mm/-
Note	

Ordering data

Version	
	Blue Wemid
Note	

Accessories

Pluggable cross-connection	
	2-pole
	3-pole
	4-pole
	10-pole
	20-/24-pole
Mounting plate for 10 x 3 (required every 20 cm)	
	Blue Wemid For a vertical installation position
End bracket	
	Dark beige Wemid
Screwdriver	
	Standard
Busbar 10 x 3 (140 A)	
	OK, Busbar up to OK, TS35 = 25,5 mm
Clamping yoke for power supply to 10 x 3 busbars	
	Rigid / flexible 0,5 - 6 / 4 mm ²
	rigid / flexible 6 - 16 mm ²
	Flexible 16 - 35 mm ²

Marking systems	(see assortment in catalogue 7)
	Marking tags
For detailed information on other accessories and applications, refer to the „Accessories“ section	

PNT 2.5/4

4 mm²

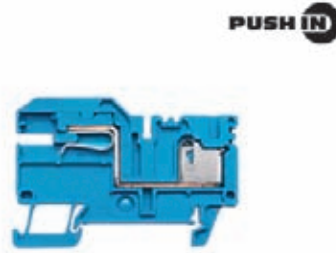

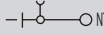
5.1 x 63.5 x 43	
/ 6	
0.08...6	

IEC 60947-7-1			
IEC	UL	CSA	
250			
32			
4			
		4 / 3	
		/ V-0	
Rated connection			
0.5...6			
2.5...4 / 0.5...4			
...1.5			
12 / 3.0 x 0.5 mm			

Type	Qty	Order No.
PNT 2.5/4	50	1896360000

Type	current	Qty	Order No.
ZQV 2.5/2	24 A	60	1608860000
ZQV 2.5/3	24 A	60	1608870000
ZQV 2.5/4	24 A	60	1608880000
ZQV 2.5/10	24 A	20	1608940000
ZQV 2.5/20	24 A	20	1908960000
Width			
PHP PNT 2.5/4	3 mm	20	1896390000
PHP PNT 2.5/4 SO	3 mm	20	1916790000
ZEW 35			
	6 mm	20	9540000000
SD 0.5x3.0x80			
		1	9008320000
SSCH 10X3X1000 CU/SN			
	10 mm	1	0348900000
ZF 4 S BL			
	22 mm	50	1814660000
ZB 16K BL			
	10 mm	50	0502880000
ZB 35/M6X16			
	14 mm	20	0266500000

DEK 5/5 / WS 10/5

PNT 6/10

10 mm²

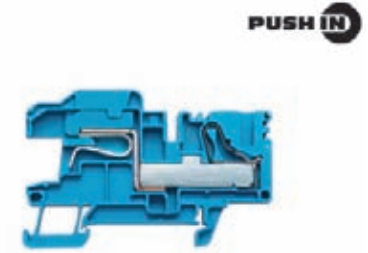

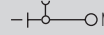
8.1 x 72.5 x 46	
/ 10	
1.5...10	

IEC 60947-7-1			
IEC	UL	CSA	
250			
57			
10	AWG 16...8	AWG 16...8	
		8 / 3	
		/ V-0	
Rated connection			
1.5...10			
1.5...10 / 1.5...10			
14 / 0.6 x 3.5 mm			

Type	Qty	Order No.
PNT 6/10	25	1896370000

Type	current	Qty	Order No.
ZQV 6N/2		60	1906210000
ZQV 6N/3		60	1906220000
ZQV 6N/4		60	1906230000
ZQV 6N/20		20	1906240000
Width			
PHP PNT 6/10	3 mm	10	1896100000
PHP PNT 6/10 SO	3 mm	10	1919710000
ZEW 35			
	6 mm	20	9540000000
SD 0.5x3.0x80			
		1	9008320000
SSCH 10X3X1000 CU/SN			
	10 mm	1	0348900000
ZF 4 S BL			
	22 mm	50	1814660000
ZB 16K BL			
	10 mm	50	0502880000
ZB 35/M6X16			
	14 mm	20	0266500000

WS 10/8

Installation terminals

Neutral conductor disconnect terminals

PNT 16

16 mm²

PUSH IN

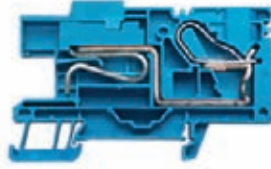

12.1 x 80.5 x 48

/ 16

2.5...16

—|—○NT

In hazardous area applications, the installation instructions and the rated data specifications for accessories given in the technical appendix must be followed.

Width/Length/height with TS35x7.5 mm
 max. current / max. cond. cross-section A/mm²
 Max. clamping range mm²

Technical data

Rated data

Rated voltage V
 Rated current A
 Rated cross-section mm²
 Rated impulse voltage / Pollution severity kV/-
 Gauge to IEC 60947-1 / UL94 Flammability class

Clamped conductors (H05V/H07V)

solid / stranded mm²
 flexible / Stranded wire with end ferrules mm²
 Twin wire-end ferrule mm²
 Stripping length / Blade size mm/-

Note

Ordering data

Version

Blue Wemid

Note

Accessories

Pluggable cross-connection



2-pole
 3-pole
 4-pole
 10-pole
 20-/24-pole

Mounting plate for 10 x 3 (required every 20 cm)



Blue Wemid
 For a vertical installation position

End bracket

Dark beige Wemid

Screwdriver

Standard

Busbar 10 x 3 (140 A)

OK, Busbar up to OK, TS35 = 25,5 mm

Clamping yoke for power supply to 10 x 3 busbars

Rigid / flexible 0,5 - 6 / 4 mm²
 rigid / flexible 6 - 16 mm²
 Flexible 16 - 35 mm²

IEC	UL	CSA
400		
76		
16	AWG 12...5	AWG 12...5
	8 / 3	
	/ V-0	

Rated connection

2.5...16
 2.5...16 / 2.5...16
 14 / 1.0 x 5.5 mm

Type	Qty	Order No.
PNT 16	10	1896350000

Type	Qty	Order No.

	Width	Qty	Order No.
PHP PNT16	3 mm	10	1896380000
PHP PNT16 SO	3 mm	10	1919690000

ZEW 35	6 mm	20	9540000000
--------	------	----	------------

SD 1.0x5.5x150		1	9008350000
----------------	--	---	------------

SSCH 10X3X1000 CU/SN	10 mm	1	0348900000
----------------------	-------	---	------------

ZF 4 S BL	22 mm	50	1814660000
-----------	-------	----	------------

ZB 16K BL	10 mm	50	0502880000
-----------	-------	----	------------

ZB 35/M6X16	14 mm	20	0266500000
-------------	-------	----	------------

Marking systems (see assortment in catalogue 7)

Marking tags

For detailed information on other accessories and applications, refer to the „Accessories“ section

WS 10/12

Distribution terminals for 10 x 3

In hazardous area applications, the installation instructions and the rated data specifications for accessories given in the technical appendix must be followed.

Width/Length/height with TS35x7.5	mm
max. current / max. cond. cross-section	A/mm ²
Max. clamping range	mm ²

Technical data

Rated data	
Rated voltage	V
Rated current	A
Rated cross-section	mm ²
Rated impulse voltage / Pollution severity	kV/-
Gauge to IEC 60947-1 / UL94 Flammability class	
Approvals	
Clamped conductors (H05V/H07V)	
solid / stranded	mm ²
flexible / Stranded wire with end ferrules	mm ²
Twin wire-end ferrule	mm ²
Stripping length / Blade size	mm/-

Note

Ordering data

Version	
	Dark beige Wemid
Note	

Accessories

Pluggable cross-connection	
	2-pole
	3-pole
	4-pole
	10-pole

End plate / partition	
	Dark beige Wemid

Mounting plate for 10 x 3 (required every 20 cm)	
	Blue Wemid
	For a vertical installation position

End bracket	
	Dark beige Wemid

Screwdriver	
	Standard

Busbar 10 x 3 (140 A)	
	OK, Busbar up to OK, TS35 = 25,5 mm

Clamping yoke for power supply to 10 x 3 busbars	
	Rigid / flexible 0,5 - 6 / 4 mm ²
	rigid / flexible 6 - 16 mm ²
	Flexible 16 - 35 mm ²

Marking systems	
	(see assortment in catalogue 7)
	Marking tags

For detailed information on other accessories and applications, refer to the „Accessories“ section

PDL4 S/NT/L/PE

4 mm²

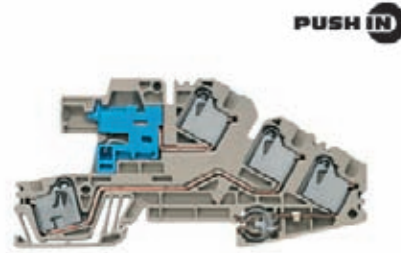

5.1 x 100 x 48.5	
36 / 6	
0.08...6	

IEC 60947-7-1 (-7-2)		
IEC	UL	CSA
400		
32		
4		
	6 / 3	
	A3 / V-0	

Rated connection	
0.5...6 / 1.5...4	
0.5...4 / 0.5...4	
0.5...1.5	
12 / 3.0 x 0.5 mm	

Type	Qty	Order No.
PDL 4 S/NT/L/PE	50	1837060000

Type	current	Qty	Order No.
ZQV 2.5/2	24 A	60	1608860000
ZQV 2.5/3	24 A	60	1608870000
ZQV 2.5/4	24 A	60	1608880000
ZQV 2.5/10	24 A	20	1608940000

Width	
PAP PDL4S	3 mm 20 1837070000

PHP PDL	20	1837090000
PHP PDL SO	20	1837080000

ZEW 35/2	8 mm	20	8630740000
----------	------	----	------------

SDI 0,4x2,5x75	1	9008370000
----------------	---	------------

SSCH 10X3X1000 CU/SN	10 mm	1	0348900000
----------------------	-------	---	------------

ZF 4 S BL	22 mm	50	1814660000
ZB 16 ZKSC	10 mm	50	0316600000
ZB 35/M6X16	14 mm	20	0266500000

DEK 5/5

PDL4 S/L/L

4 mm²

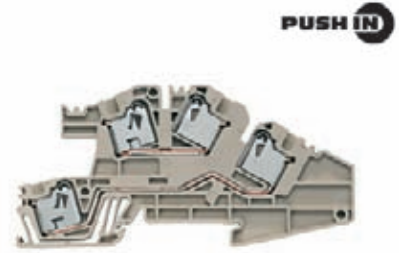

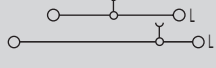
5.1 x 100 x 48.5	
36 / 6	
0.08...6	

IEC 60947-7-1		
IEC	UL	CSA
400		
32		
4		
	6 / 3	
	A3 / V-0	

Rated connection	
0.5...6 / 1.5...4	
0.5...4 / 0.5...4	
0.5...1.5	
12 / 3.0 x 0.5 mm	

Type	Qty	Order No.
PDL 4 S/L/L	50	1837030000

Type	current	Qty	Order No.
ZQV 2.5/2	24 A	60	1608860000
ZQV 2.5/3	24 A	60	1608870000
ZQV 2.5/4	24 A	60	1608880000
ZQV 2.5/10	24 A	20	1608940000

Width	
PAP PDL4S	3 mm 20 1837070000

PHP PDL	20	1837090000
PHP PDL SO	20	1837080000

ZEW 35/2	8 mm	20	8630740000
----------	------	----	------------

SDI 0,4x2,5x75	1	9008370000
----------------	---	------------

SSCH 10X3X1000 CU/SN	10 mm	1	0348900000
----------------------	-------	---	------------

ZF 4 S BL	22 mm	50	1814660000
ZB 16 ZKSC	10 mm	50	0316600000
ZB 35/M6X16	14 mm	20	0266500000

DEK 5/5

Installation terminals

Distribution terminals for 10 x 3

In hazardous area applications, the installation instructions and the rated data specifications for accessories given in the technical appendix must be followed.

Width/Length/height with TS35x7.5	mm
max. current / max. cond. cross-section	A/mm ²
Max. clamping range	mm ²



Technical data

Rated data	
Rated voltage	V
Rated current	A
Rated cross-section	mm ²
Rated impulse voltage / Pollution severity	kV/-
Gauge to IEC 60947-1 / UL94 Flammability class	
Approvals	
Clamped conductors (H05V/H07V)	
solid / stranded	mm ²
flexible / Stranded wire with end ferrules	mm ²
Twin wire-end ferrule	mm ²
Stripping length / Blade size	mm/-
Note	

Ordering data

Version	Dark beige Wemid
Note	

Accessories

Pluggable cross-connection	
	2-pole 3-pole 4-pole 10-pole
End plate / partition	
	Dark beige Wemid
Mounting plate for 10 x 3 (required every 20 cm)	
	Blue Wemid For a vertical installation position
End bracket	
	Dark beige Wemid
Screwdriver	
	Standard
Busbar 10 x 3 (140 A)	
	OK, Busbar up to OK, TS35 = 25,5 mm
Clamping yoke for power supply to 10 x 3 busbars	
	Rigid / flexible 0,5 - 6 / 4 mm ² rigid / flexible 6 - 16 mm ² Flexible 16 - 35 mm ²
Marking systems	
	(see assortment in catalogue 7) Marking tags
For detailed information on other accessories and applications, refer to the „Accessories“ section	

PDL 4 S/L

4 mm²

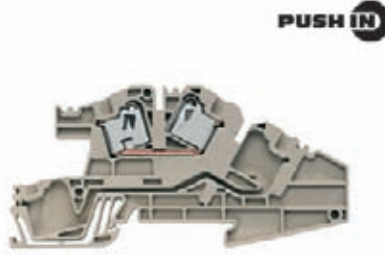

5.1 x 100 x 48.5	
36 / 6	
0.08...6	

IEC 60947-7-1		
IEC	UL	CSA
400		
32		
4		
	6 / 3	
	A3 / V0	
KEF		
Rated connection		
0.5...6 / 1.5...4		
0.5...4 / 0.5...4		
0.5...1.5		
12 / 3.0 x 0.5 mm		
Can be used with ultrasonically welded conductors ranging from 0.5 ... 4 mm ² .		

Type	Qty	Order No.
PDL 4 S/L	50	1847610000

Type	current	Qty	Order No.
ZQV 2.5/2	24 A	60	1608860000
ZQV 2.5/3	24 A	60	1608870000
ZQV 2.5/4	24 A	60	1608880000
ZQV 2.5/10	24 A	20	1608940000
Width			
PAP PDL4S	3 mm	20	1837070000
PHP PDL		20	1837090000
PHP PDL SO		20	1837080000
ZEW 35/2	8 mm	20	8630740000
SDI 0,4x2,5x75		1	9008370000
SSCH 10X3X1000 CU/SN	10 mm	1	0348900000
ZF 4 S BL	22 mm	50	1814660000
ZB 16 ZKSC	10 mm	50	0316600000
ZB 35/M6X16	14 mm	20	0266500000

DEK 5/5

PDL4 S/N/L/PE

4 mm²

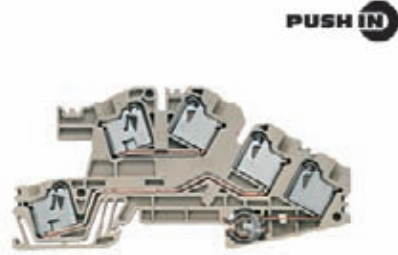

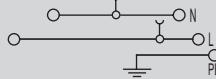
5.1 x 100 x 48.5	
36 / 6	
0.08...6	

IEC 60947-7-1 (-7-2)		
IEC	UL	CSA
400		
32		
4		
	6 / 3	
	A3 / V-0	
KEF		
Rated connection		
0.5...6 / 1.5...4		
0.5...4 / 0.5...4		
0.5...1.5		
12 / 3.0 x 0.5 mm		

Type	Qty	Order No.
PDL 4 S/N/L/PE	50	1837050000

Type	current	Qty	Order No.
ZQV 2.5/2	24 A	60	1608860000
ZQV 2.5/3	24 A	60	1608870000
ZQV 2.5/4	24 A	60	1608880000
ZQV 2.5/10	24 A	20	1608940000
Width			
PAP PDL4S	3 mm	20	1837070000
PHP PDL		20	1837090000
PHP PDL SO		20	1837080000
ZEW 35/2	8 mm	20	8630740000
SDI 0,4x2,5x75		1	9008370000
SSCH 10X3X1000 CU/SN	10 mm	1	0348900000
ZF 4 S BL	22 mm	50	1814660000
ZB 16 ZKSC	10 mm	50	0316600000
ZB 35/M6X16	14 mm	20	0266500000

DEK 5/5

PDL 4 S/N/L

4 mm²

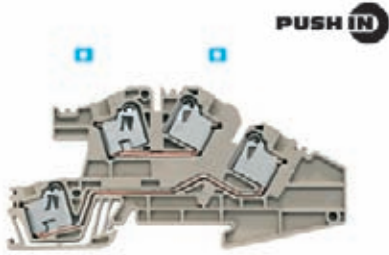

5.1 x 100 x 48.5
36 / 6
0.08...6

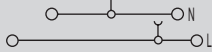

IEC 60947-7-1

IEC	UL	CSA
400		
32		
4		
	6 / 3	
	A3 / V-0	

KEF

Rated connection

0.5...6 / 1.5...4
 0.5...4 / 0.5...4
 0.5...1.5
 12 / 3.0 x 0.5 mm

Type	Qty	Order No.
PDL 4 S/N/L	50	1847630000

Type	current	Qty	Order No.
ZQV 2.5/2	24 A	60	1608860000
ZQV 2.5/3	24 A	60	1608870000
ZQV 2.5/4	24 A	60	1608880000
ZQV 2.5/10	24 A	20	1608940000
Width			
PAP PDL4S	3 mm	20	1837070000
PHP PDL		20	1837090000
PHP PDL SO		20	1837080000
ZEW 35/2	8 mm	20	8630740000
SDI 0,4x2,5x75		1	9008370000
SSCH 10X3X1000 CU/SN	10 mm	1	0348900000
ZF 4 S BL	22 mm	50	1814660000
ZB 16 ZKSC	10 mm	50	0316600000
ZB 35/M6X16	14 mm	20	0266500000

DEK 5/5

PDL 4 S/N

4 mm²



5.1 x 100 x 48.5
36 / 6
0.08...6

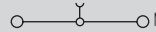

IEC 60947-7-1

IEC	UL	CSA
400		
32		
4		
	6 / 3	
	A3 / V-0	

KEF

Rated connection

0.5...6 / 1.5...4
 0.5...4 / 0.5...4
 0.5...1.5
 12 / 3.0 x 0.5 mm

Type	Qty	Order No.
PDL 4 S/N	50	1847620000

Type	current	Qty	Order No.
ZQV 2.5/2	24 A	60	1608860000
ZQV 2.5/3	24 A	60	1608870000
ZQV 2.5/4	24 A	60	1608880000
ZQV 2.5/10	24 A	20	1608940000
Width			
PAP PDL4S	3 mm	20	1837070000
PHP PDL		20	1837090000
PHP PDL SO		20	1837080000
ZEW 35/2	8 mm	20	8630740000
SDI 0,4x2,5x75		1	9008370000
SSCH 10X3X1000 CU/SN	10 mm	1	0348900000
ZF 4 S BL	22 mm	50	1814660000
ZB 16 ZKSC	10 mm	50	0316600000
ZB 35/M6X16	14 mm	20	0266500000

DEK 5/5

PDL4 S/L/L/PE

4 mm²



5.1 x 100 x 48.5
36 / 6
0.08...6

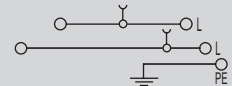

IEC 60947-7-1 (-7-2)

IEC	UL	CSA
400		
32		
4		
	6 / 3	
	A3 / V-0	

KEF

Rated connection

0.5...6 / 1.5...4
 0.5...4 / 0.5...4
 0.5...1.5
 12 / 3.0 x 0.5 mm

Type	Qty	Order No.
PDL 4 S/L/L/PE	50	1837040000

Type	current	Qty	Order No.
ZQV 2.5/2	24 A	60	1608860000
ZQV 2.5/3	24 A	60	1608870000
ZQV 2.5/4	24 A	60	1608880000
ZQV 2.5/10	24 A	20	1608940000
Width			
PAP PDL4S	3 mm	20	1837070000
PHP PDL		20	1837090000
PHP PDL SO		20	1837080000
ZEW 35/2	8 mm	20	8630740000
SDI 0,4x2,5x75		1	9008370000
SSCH 10X3X1000 CU/SN	10 mm	1	0348900000
ZF 4 S BL	22 mm	50	1814660000
ZB 16 ZKSC	10 mm	50	0316600000
ZB 35/M6X16	14 mm	20	0266500000

DEK 5/5

Installation terminals

Modular distribution terminals

In hazardous area applications, the installation instructions and the rated data specifications for accessories given in the technical appendix must be followed.

Width/Length/height with TS35x7.5	mm
max. current / max. cond. cross-section	A/mm ²
Max. clamping range	mm ²

Technical data

Rated data	
Rated voltage	V
Rated current	A
Rated cross-section	mm ²
Rated impulse voltage / Pollution severity	kV/-
Gauge to IEC 60947-1 / UL94 Flammability class	
Approvals	

Clamped conductors (H05V/H07V)	
solid / stranded	mm ²
flexible / Stranded wire with end ferrules	mm ²
Twin wire-end ferrule	mm ²
Stripping length / Blade size	mm/-

Note

Ordering data

Version	Dark beige Wemid
Note	

Accessories

Pluggable cross-connection	
	2-pole
	3-pole
	4-pole
	10-pole
End plate / partition	
	Dark beige Wemid
End bracket	
	Dark beige Wemid
Screwdriver	
	Standard

Marking systems (see assortment in catalogue 7)
Marking tags

For detailed information on other accessories and applications, refer to the „Accessories“ section

PDL4 NT/L/PE

4 mm²

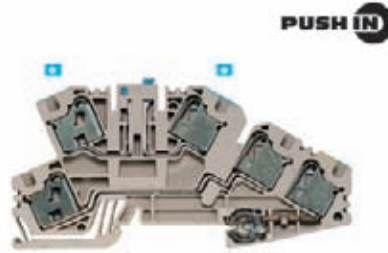

5.1 x 100 x 48.5	
/ 6	
0.08...6	

IEC	UL	CSA
400	300	300
20	10	10
4	AWG 28...10	AWG 28...10
	6 / 3	
	A3 / V0	

Rated connection
0.5...6 / 1.5...4
0.5...4 / 0.5...4
0.5...1.5
12 / 3.0 x 0.5 mm
30A bottom level
20A top level

Type	Qty	Order No.
PDL 4/NT/L/PE	50	1882620000

Type	current	Qty	Order No.
ZQV 2.5/2	24 A	60	1608860000
ZQV 2.5/3	24 A	60	1608870000
ZQV 2.5/4	24 A	60	1608880000
ZQV 2.5/10	24 A	20	1608940000
Width			
PAP PDL4	3 mm	20	1883210000
ZEW 35/2	8 mm	20	8630740000
SDI 0,4x2,5x75		1	9008370000

DEK 5/5

PDL4 NT/L

4 mm²

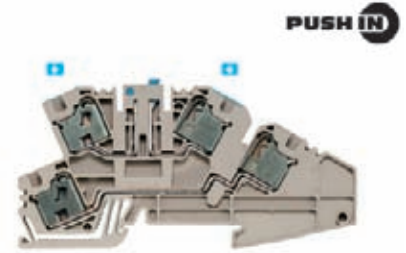

5.1 x 100 x 48.5	
/ 6	
0.08...6	

IEC	UL	CSA
400	300	300
20	10	10
4	AWG 28...10	AWG 28...10
	6 / 3	
	A3 / V0	

Rated connection
0.5...6 / 1.5...4
0.5...4 / 0.5...4
0.5...1.5
12 / 3.0 x 0.5 mm
30A bottom level
20A top level

Type	Qty	Order No.
PDL 4/NT/L	50	1882600000

Type	current	Qty	Order No.
ZQV 2.5/2	24 A	60	1608860000
ZQV 2.5/3	24 A	60	1608870000
ZQV 2.5/4	24 A	60	1608880000
ZQV 2.5/10	24 A	20	1608940000
Width			
PAP PDL4	3 mm	20	1883210000
ZEW 35/2	8 mm	20	8630740000
SDI 0,4x2,5x75		1	9008370000

DEK 5/5

PDL4 N/L/PE

4 mm²

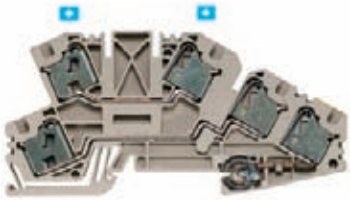

5.1 x 100 x 48.5
/ 6
0.08...6

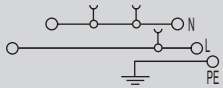

IEC	UL	CSA
400		
32		
4		
	6 / 3	
	A3 / V-0	

Rated connection

0.5...6 / 1.5...4
0.5...4 / 0.5...4
0.5...1.5
12 / 3.0 x 0.5 mm

Type	Qty	Order No.
PDL 4/N/L/PE	50	1899180000

Type	current	Qty	Order No.
ZQV 2.5/2	24 A	60	1608860000
ZQV 2.5/3	24 A	60	1608870000
ZQV 2.5/4	24 A	60	1608880000
ZQV 2.5/10	24 A	20	1608940000
Width			
PAP PDL4	3 mm	20	1883210000
ZEW 35/2	8 mm	20	8630740000
SDI 0,4x2,5x75		1	9008370000

DEK 5/5

PDL4 L/L/PE

4 mm²



5.1 x 100 x 48.5
/ 6
0.08...6

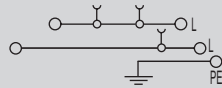

IEC	UL	CSA
400		
32		
4		
	6 / 3	
	A3 / V-0	

Rated connection

0.5...6 / 1.5...4
0.5...4 / 0.5...4
0.5...1.5
12 / 3.0 x 0.5 mm

Type	Qty	Order No.
PDL 4/L/L/PE	50	1882610000

Type	current	Qty	Order No.
ZQV 2.5/2	24 A	60	1608860000
ZQV 2.5/3	24 A	60	1608870000
ZQV 2.5/4	24 A	60	1608880000
ZQV 2.5/10	24 A	20	1608940000
Width			
PAP PDL4	3 mm	20	1883210000
ZEW 35/2	8 mm	20	8630740000
SDI 0,4x2,5x75		1	9008370000

DEK 5/5

PDL4 L/L

4 mm²



5.1 x 100 x 48.5
/ 6
0.08...6

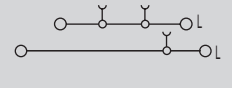

IEC	UL	CSA
400		
32		
4		
	6 / 3	
	A3 / V-0	

Rated connection

0.5...6 / 1.5...4
0.5...4 / 0.5...4
0.5...1.5
12 / 3.0 x 0.5 mm

Type	Qty	Order No.
PDL 4/L/L	50	1882590000

Type	current	Qty	Order No.
ZQV 2.5/2	24 A	60	1608860000
ZQV 2.5/3	24 A	60	1608870000
ZQV 2.5/4	24 A	60	1608880000
ZQV 2.5/10	24 A	20	1608940000
Width			
PAP PDL4	3 mm	20	1883210000
ZEW 35/2	8 mm	20	8630740000
SDI 0,4x2,5x75		1	9008370000

DEK 5/5

The additional functions

Introduction

The accessories for the other ranges of modular terminals can also be used with the P-Series in order to reduce the number of variations. The use of accessories, enable users to adapt and mould the Terminals, to perfect match the needs of the application.

All Weidmüller accessories are built to the same high quality standards as the terminals themselves.

Retaining and end plates

Page B.28



End plates cover the open side of the terminals. This ensures touch protection for fingers and hands.

Retaining plates, which for the P-Series also function as end plates, must be positioned every 200 mm when using the 10 x 3 busbar.

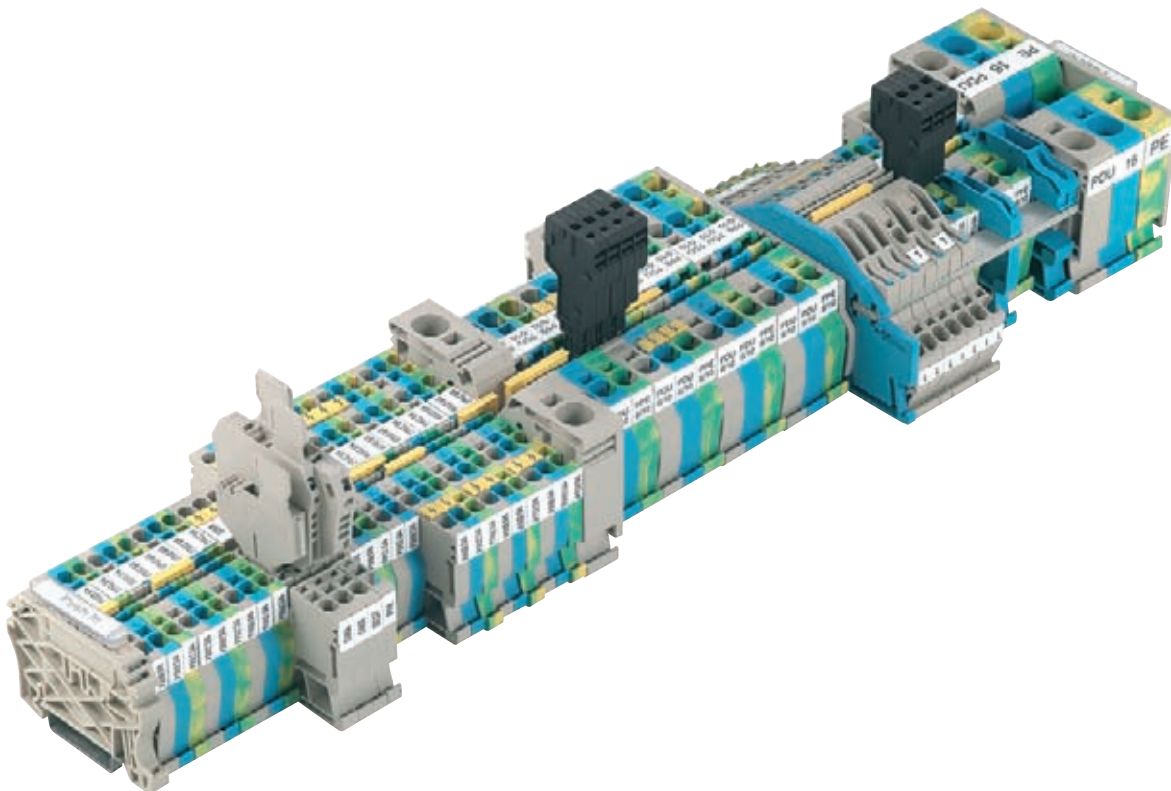

Fastening

Chapter G

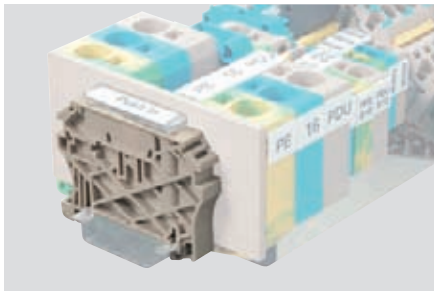

An end bracket is fitted on the mounting rail to the right and left of the terminals to ensure that they sit firmly in position. The marking surface of the end bracket can also be used for group marking. Details of the wide range of Weidmüller end brackets and mounting rails are given in **chapter G**.

Electrical supply

Page B.29

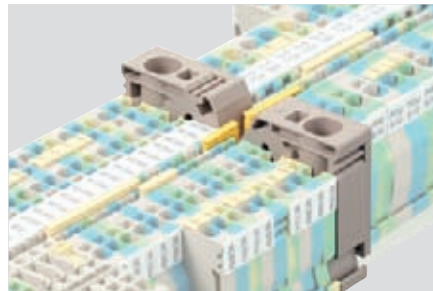

There are three options for supplying power to the Weidmüller Push In modular terminals:
with the **PEI 16** supply terminal and with the PDU 6/10 or PDU 2.5/4 feed-through terminal. The input current is split into several output currents by means of cross-connections. A 16 mm² conductor carries the incoming supply, which is distributed to the neighbouring terminals for cross-sections from 0.5 to 10 mm².

Electrical distribution

Page B.30

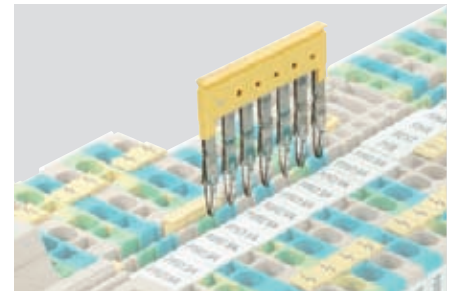

A pluggable **cross-connection system (ZQV)** is available for all P-Series terminals. The current is distributed across any number of terminals by simply plugging the cross-connection into the middle of the terminals. As a rule, 400 V can be conveyed across the cross-section, depending on the rated voltage of the terminal.

Testing

Page B.32

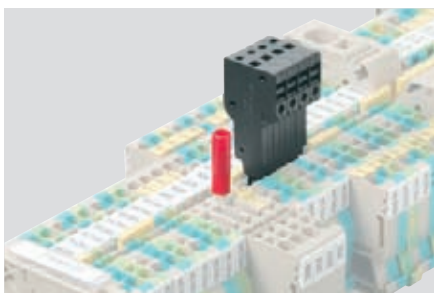

The plug-in **test adapter (PTA)** is used as a single unit and as a test adapter strip for voltage measurement in control cabinets. The test adapter is ideal for convenient, testing of assembled terminals. It is simply clipped into the cross-connection channel of the terminal. This ensures that it makes contact with the busbar carrying the current.

Marking

Page B.32



Weidmüller's marking systems in **chapter G** are used to mark Push In technology terminals. Individual terminals, groups of terminals and cables or conductors can be marked. Marker strips are available for every size of terminal, which means that several terminals can be marked together.

Connecting

Page B.35



The Push-In connection saves time and requires solid single-core wires or wire-end ferrules. Ferrules have well-established installation advantages. In addition, they guarantee an electrical connection of permanent and consistent quality. By using twin ferrules, it is possible to connect two wires in one terminal point.

Accessories - Support and end plates

Support plates and end plates

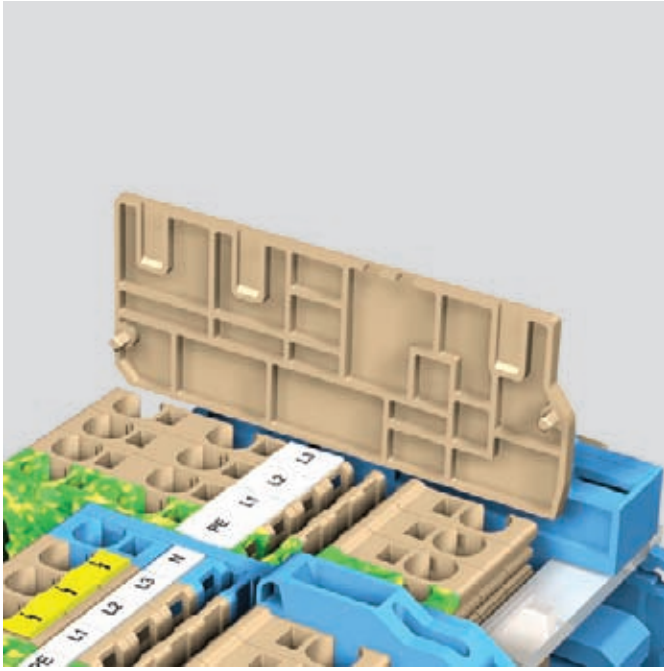

Touch-safe protection

With only a few exceptions, the last terminal in a terminal strip must be closed off with a PAP-type end plate. End plates must also be used within a terminal strip when it makes use of terminals of different sizes. This ensures the touch-safe requirement is met for live voltage components. The terminals have touch protection.

Ensuring the operating voltage

End plates can also be used to maintain the required clearance and creepage distances, in order to guarantee the rated voltage for the application. They can be used, for example, when cross-connections are used side-by-side.

Contour matching

The outer dimensions of the end plates match the external dimensions of the associated terminal.

Mounting

The end plate's snap-in pegs allow it to be simply fitted on to the corresponding terminal. The corresponding indentations in the terminal are used to ensure that position follows the identical contours.

Ordering data

Type	Colour	Qty	Order No.	For terminal:
Width 3 mm				
PAP 2.5/4	dark beige	50	1896300000	PDU 2.5/4 PDU 2.5/4 BL PNT 2.5/4 PPE 2.5/4
Width 3 mm				
PAP 2.5/4/3AN	dark beige	50	1896480000	PDU 2.5/4 3AN PDU 2.5/4 3AN BL PPE 2.5/4 3AN
Width 3 mm				
PAP 2.5/4/4AN	dark beige	50	1896320000	PDU 2.5/4 2x2 PDU 2.5/4 4AN PDU 2.5/4 4AN BL PPE 2.5/4 4AN
Width 3 mm				
PHP PNT 2.5/4	blue	20	1896390000	PNT 2.5/4
Width 3 mm				
PAP PDK 2.5/4	dark beige	20	1919720000	PKD 2.5/4 PKD 2.5/4 BL PKD 2.5/4 PE PKD 2.5/4L-PE PKD 2.5/4N-L PKD 2.5/4V PKD 2.5/4V BL
Width 3 mm				
PAP PDU6/10	dark beige	20	1896330000	PDU 6/10 PDU 6/10 BL PPE 6/10 PPE 6/10 3AN
Width 3 mm				
PAP PDU6/10/3AN	dark beige	20	1896340000	PDU 6/10 3AN PDU 6/10 3AN BL
Width 3 mm				
PHP PNT 6/10	blue	10	1896100000	PNT 6/10
Width 3 mm				
PAP 16	dark beige	10	1896290000	PDU 16 PDU 16 BL PPE 16
Width 3 mm				
PHP PNT16	blue	10	1896380000	PNT 16

Feeding with standard terminals

Using standard terminals for the supply is ideal because the feed-through terminals of the P-Series exhibit a very wide clamping range.

Left-hand feed

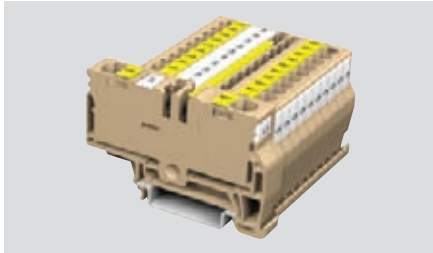

Right-hand feed



Feed options and cross-connections to be used

Feed terminal	Output terminal	Cross-connection	Left-hand feed	Right-hand feed
PDU 2.5/4	PDU 2.5/4	ZQV 2.5/...	•	•
	PDU 2.5/4/3AN	ZQV 2.5/...	•	
	PDU 2.5/4/4AN	ZQV 2.5/...	•	
	PTR 2.5/4	ZQV 2.5/...	•	
PDU 2.5/4/3AN	PDU 2.5/4	ZQV 2.5/...		•
	PDU 2.5/4/3AN	ZQV 2.5/...	•	•
	PDU 2.5/4/4AN	ZQV 2.5/...	•	
PDU 2.5/4/4AN	PDU 2.5/4	ZQV 2.5/...		•
	PDU 2.5/4/3AN	ZQV 2.5/...		•
	PDU 2.5/4/4AN	ZQV 2.5/...	•	•
PTR 2.5/4	PKD 2.5/4	ZQV 2.5/...	•	
PDU 6/10	PDU 2.5/4	ZQV 2.5/...		•
	PDU 2.5/4/4AN	ZQV 2.5/...	•	
	PDU 6/10	ZQV 6N/...	•	•
	PDU 6/10/3AN	ZQV 6N/...	•	
PDU 6/10/3AN	PTR 2.5/4	ZQV 2.5/...		•
	PDU 2.5/4	ZQV 2.5/...		•
	PDU 2.5/4/3AN	ZQV 2.5/...		•
	PDU 6/10	ZQV 6N/...	•	
	PDU 6/10/3AN	ZQV 6N/...	•	•
PTR 2.5/4	PDU 2.5/4	ZQV 2.5/...		•
	PDU 6/10/3AN	ZQV 6N/...		•

Feed terminal PEI 16

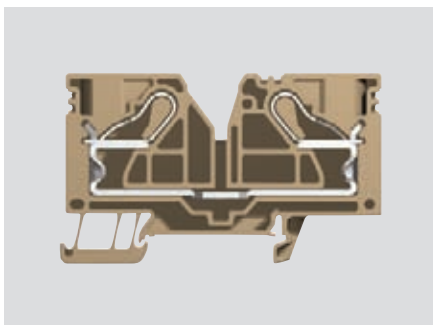

A supply cable with a cross-section of up to 25 mm² is possible with the PEI 16 feed terminal.

Standard cross-connections are used to distribute the current to any number of terminals with a smaller cross-section.

The table on the right shows a number of variations for distributing the current with the cross-connection specified.

Output possible on left and right

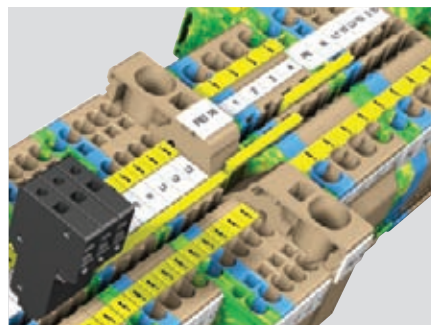

Output options and cross-connections to be used

Feed terminal	Output terminal	Cross-connection	Left-hand feed	Right-hand feed
PEI 16	PDU 2.5/4	ZQV 2.5/...	•	•
	PDU 2.5/4/3AN	ZQV 2.5/...	•	•
	PDU 2.5/4/4AN	ZQV 2.5/...	•	•
	PTR 2.5/4	ZQV 2.5/...		•
	PDU 6/10	ZQV 6N...	•	•
	PDU 6/10 3AN	ZQV 6N...	•	•

Accessories – Electrical distribution

Plug-in cross-connection ZQV



The time-saving, easy-to-use cross-connection combs for terminals, featuring Push In technology.

- **ZQV 2.5** as 2- to 10-pole combs and ZQV2.5/20 – continuous (20-pole)
- **ZQV 6/N** as 2- to 4-pole combs and ZQV6N/20 – continuous (24-pole)
- **ZQV 16/2** as 2-pole comb (link)

These versions come with complete shock protection.

Tailor-made cross-connections

ZQV is a cross-connection which can be used for connecting up to 20 individual terminals easily and quickly. The fitter simply cuts off the required number of poles from the 20-pole cross-connection comb.

With this system, cross-connections with the correct number of poles are always available and only a minimum of storage space is required.

The ends of the continuous cross-connection are bare. In the interests of stability, 2-pole cross-connections are not permitted. An end cover plate must always be fitted to neighbouring ZQVs with bare cut edges.

Breaking out contact elements

Breaking out one or more (max. 60 %) contact elements from cross-connections enables certain terminals to be bypassed to suit the application.



Fitting and changing cross-connections

The fitting and changing of cross-connections is a trouble-free and fast operation:

- Insert the cross-connection into the cross-connection channel in the terminal...

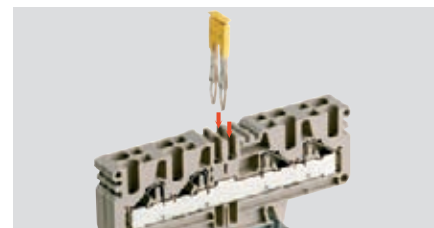

... and press it fully home. (The cross-connection may not project from the channel.)

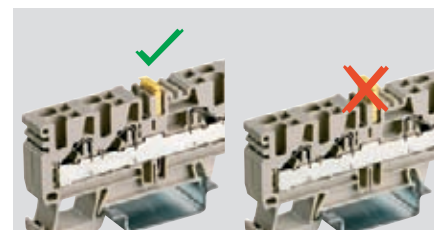

- Remove a cross-connection by simply prising it out with a screwdriver.



Shortening cross-connections

Cross-connections can be shortened in length using a suitable cutting tool, e.g. KT ZQV (order no. 9002170000). However, three contact elements must always be retained.

Caution:

Contact elements must not be deformed!

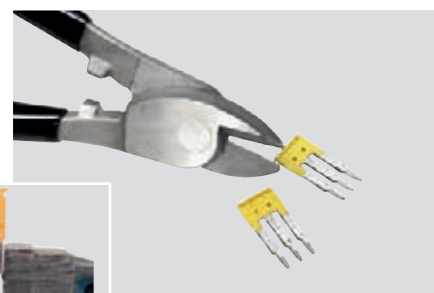

An end plate (PAP) must be fitted between the bare cut edges of two cross-connections in order to maintain the rated voltage.

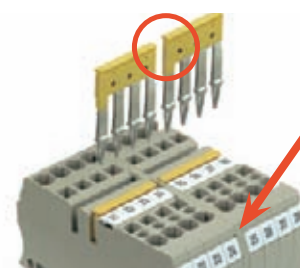

Possible combinations

In one cross-connection channel

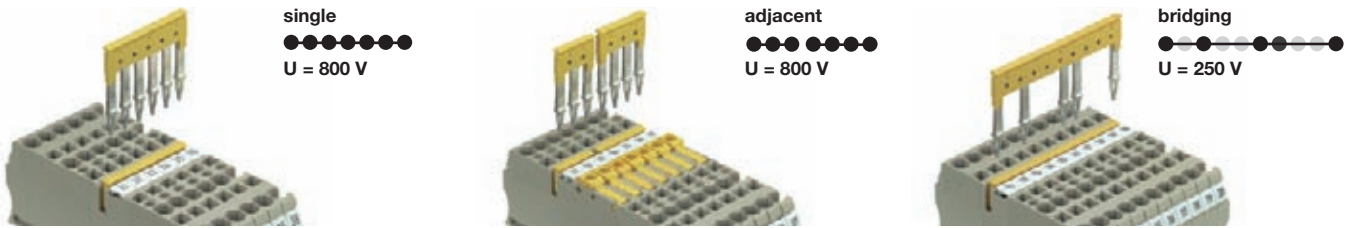

In two cross-connection channels

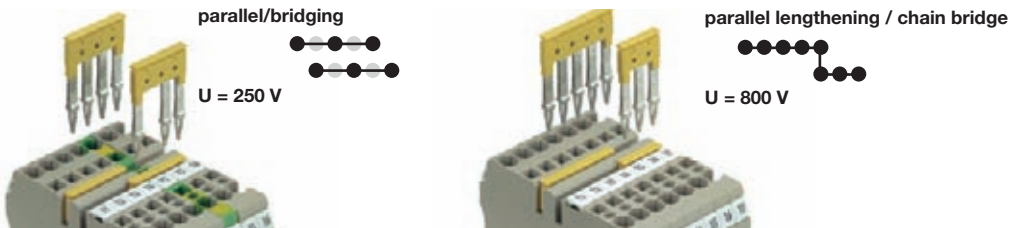

Possible cross-connections of terminals of the same type with corresponding cross-connectors

Terminal type	Cross-connection	single	adjacent	bridging	parallel bridging	chain bridge parallel/lengthening
Standard terminals						
PDU 2.5/4	ZQV 2.5/...	•	•	•	•	•
PDU 2.5/4/3AN	ZQV 2.5/...	•	•	•	•	•
PDU 2.5/4/4AN	ZQV 2.5/...	•	•	•	•	•
PDU 6/10	ZQV 6N/...	•	•	•	•	•
PDU 6/10/3AN	ZQV 6N/...	•	•	•	•	•
PDU 16	ZQV 16/2	•	•			•

The ZQV 2.5/20 cross-connector allows you to easily and separately connect up to 20 terminals with each other. The electrician can cut off the required amount of contact elements from the continuous 20-pole cross-connection comb.

ZQV 2.5



ZQV 6 N



ZQV 16/2



Technical data	
Current	A
Ordering data	
2-pole	
3-pole	
4-pole	
5-pole	
6-pole	
7-pole	
8-pole	
9-pole	
10-pole	
20-pole	

24 / 24			
Type	Qty	Order No.	
ZQV 2.5/2	60	1608860000	
ZQV 2.5/3	60	1608870000	
ZQV 2.5/4	60	1608880000	
ZQV 2.5/5	20	1608890000	
ZQV 2.5/6	20	1608900000	
ZQV 2.5/7	20	1608910000	
ZQV 2.5/8	20	1608920000	
ZQV 2.5/9	20	1608930000	
ZQV 2.5/10	20	1608940000	
ZQV 2.5/20	20	1908960000	
For terminal:			
PDL 4 ...			
PDL 4S ...			
PDU 2.5/4 ...			
PDIC 2.5/4			

76 / 76			
Type	Qty	Order No.	
ZQV 6N/2	60	1906210000	
ZQV 6N/3	60	1906220000	
ZQV 6N/4	60	1906230000	
ZQV 6N/20	20	1906240000	
For terminal:			
PDU 6/10			
PDU 6/10 3AN			
PNT 6/10			

76 / 76			
Type	Qty	Order No.	
ZQV 16/2	25	1739690000	
For terminal:			
PDU 16			

Accessories - Testing / checking

Test adapter

The clip-on test adapter PTA is used as a single thin element and as a test adapter strip for voltage measurements in electrical cabinets. Conductors with cross-sections from 0.5 mm² to 1.5 mm² can be connected. The test adapter simply clips onto the terminal and thus guarantees reliable contact with the live busbar.

Dimensions		5.1 / 20 / 59		
Width / Length / Height	mm			
Stripping length	mm	6		
Rated data				
Rated voltage	V	250		
Rated current	A	17.5		
Rated cross-section	mm ²	1.5		
Clamped conductors (H05V/H07V)				
solid / stranded	mm ²	0.5...1.5		
flexible / Flexible with ferrule	mm ²	0.5...1.5 / 0.5...1.5		
Ordering data		Type	Qty	Order No.
	1-pole	PTA PDU2.5/4	25	1916180000
	With snap-in pegs	PTA ZA PDU2.5/4	25	1916190000
For terminal:		PDU 2.5/4		

PTA

With assembly peg



Reducing sleeves

The use of reducing sleeves simplifies the connection of conductors with smaller cross-sections. Conductors can be reliably inserted into the clamping point without the strands fraying. The use of a reducing sleeve centres the conductor in the entry point. Packaged in sets of 100 x 10-pole strips

Technical data		Reducing sleeve		
Product type				
Ordering data		Type	Qty	Order No.
	For conductor 0,5 mm ² , grey	PRH 2.5/4/1	100	1916410000
	For conductor 1 mm ² , dark grey	PRH 2.5/4/2	100	1916400000
For terminal:		PDU 2.5/4 PDK 2.5/4		

PRH 2.5/4

Reducing sleeves



Cover

The VDE standards call for power connection terminals to be covered. For this purpose, Weidmüller can supply yellow warning PAD covers with the „lightning flash“ symbol. The cover is clipped into the screwdriver slit in the terminal and each one covers a group of four terminals.

Technical data		end plate and intermediate plate		
Product type				
Ordering data		Type	Qty	Order No.
	Terminal width, 5,1 mm	PAD 2.5/4/4	80	1916150000
	Terminal width, 8 mm	PAD 6/10/4	80	1916160000
	Terminal width, 12 mm	PAD 16/4	80	1916170000
For terminal:		PDU 2.5/4 ... PTR 2.5/4 ... PDK 2.5/4 ... PDU 6/10 ... PDU 16 ...		

PAD



Label

The BZT marking tags enable you to label the middle of the marking channel with the **WS 10/5** tags. The marking tags can be put together with pins in order to achieve the greatest degree of stability.

Technical data		Marker holder		
Product type				
Ordering data		Type	Qty	Order No.
	One-sided, without peg	BZT 1 WS 10/5	100	1805490000
	One-sided, with peg	BZT 1 ZA WS 10/5	100	1805520000
	Two-sided without pin	BZT 2 WS 10/5	100	1805480000
	Two-sided, with pin	BZT 2 ZA WS 10/5	100	1805530000
For terminal:		PDK 2.5/4 ... PDL 4 ...		

BZT 1/BZT 2



SIHA fuse holder

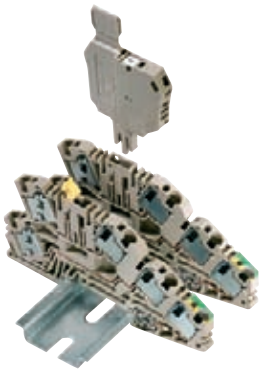

1. Open fuse holder with fingers or screwdriver.



2. Press out old fuse.

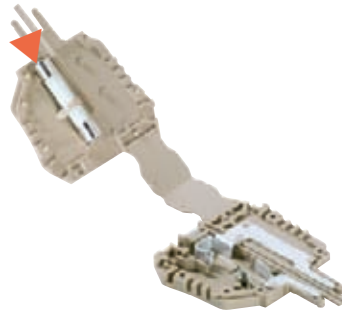

3. Position new fuse.



4. Press fuse holder together again with fingers or screwdriver.

For 5 x 20 G-fuse cartridges

The SIHA fuse holder converts a simple terminal into a fuse terminal in next to no time.

Simply remove the disconnect lever and insert the fuse plug.

Better: order the PDL 4... OTNHE and insert the SIHA immediately.

- Simple handling without tools
- Housing made of Wemid (V0)
- Rated current 6.3 A
- Even fits on 5 mm wide terminals when fitted in offset arrangement

SIHA 3



- Marking position for Dekafix 5 and space for the E-Fix self-adhesive label, size 8/20



SIHA STRAP

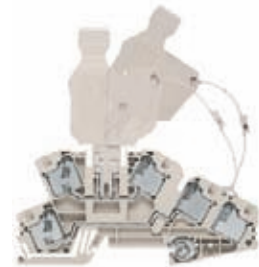

	Qty.	Order No.
without LED		
SIHA3/G20	400 V 1	7921560000
with LED (red)		
SIHA3/G20	10 - 36 V 1	7921570000
	35 - 70 V 1	7921580000
	60 - 150 V 1	7921590000
	140 - 250 V 1	7921600000

For test-disconnect terminals versions

PTR 2.5/4...
PDL 4 TR/...

	Qty.	Order No.
with strap		
SIHA STRAP	20	9537680000

Connector for retro-fit assembly

- Receptacle in the terminal is the marking position
- Integrated marking position on the strap
- Slots into fuse holder either on the left or on the right

Applications with PTR 2.5/4..., PDL 4 TR/... and SIHA 3

		Short-circuit protection		Overload and short-circuit protection	
		Nom. value		Nom. value	
		Power loss	Rated current	Power loss	Rated current
PTR 2.5/4...	Single	4.0 W	6.3 A	1.6 W	6.3 A
	Group	1.6 W	6.3 A		
PDL 4 TR/... and SIHA 3	Single	1.6 W	6.3 A	1.6 W	6.3 A
	Group	1.6 W	6.3 A		

Cartridge fuses and gauge pieces for Weidmüller fuse terminals and SIHA 3 fuse holder

Cartridge fuses

for terminal type

SIHA 3



Technical data / Ordering data

G-type cartridge fuses 5 x 20 without indicators to IEC 60127-2 (VDE 0820 pt.2 B1)

Size (mm)	Nom. current (A)	Type	Qty.	Order No.
5 x 20	0.1	(F) G 20/0.10A/F	10	0430300000
	0.2	(F) G 20/0.20A/F	10	0430400000
breaking capacity 1500 A (at 250 V, 50 Hz, cos : 0,7)	0.25	(F) G 20/0.25A/F	10	0430500000
	0.5	(F) G 20/0.50A/F	10	0430600000
	0.63	(F) G 20/0.63A/F	10	0439000000
	1.0	(F) G 20/1.00A/F	10	0430700000
	1.6	(F) G 20/1.60A/F	10	0430800000
	2.0	(F) G 20/2.00A/F	10	0430900000
	2.5	(F) G 20/2.50A/F	10	0431000000
	3.15	(F) G 20/3.15A/F	10	0431100000
	4.0	(F) G 20/4.00A/F	10	0431200000
	5.0	(F) G 20/5.00A/F	10	0431300000
	6.3	(F) G 20/6.30A/F	10	0431400000

(M) = medium-blow (F) = fast-blow

Component/isolating plugs

The Weidmüller philosophy is to realise a multitude of applications with just a few parts. The component and isolating plugs (BEST and TNST) represent a logical extension of this cost-effective and efficient approach. The component plug can accommodate electronic components and connect them to the terminal. And once an isolating plug is removed, the clamping point is obviously disconnected. The opening is easy to recognise.

An unintentional reconnection of the circuit is prevented by simply removing the isolating plug. The BEST and the TNST have the same pin arrangement. Both plugs are also identical with the SIHA 3 fuse holder, meaning that they can be used in all the "disconnecting products" of the W-, Z-, I- and P-Series.

Component plug (up to 250 V)

For terminal type

PTR 2.5/4..., PDL 4 TR/...
can be reversed

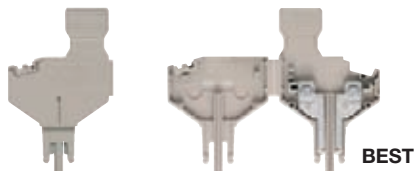

Ordering data

Type	Fitted with...	Qty.	Order No.
BEST	without	25	1833100000
BEST/DRBR	wire jumper	25	1878570000
BEST/D	diode 1N4007	25	1878560000

Isolating plug

For terminal type

PTR 2.5/4..., PDL 4 TR/...



Ordering data

Type	Colour	Qty.	Order No.
TNST	yellow Wemid	25	1833090000

Crimp-Set PZ 6 roto Push In



Assembly

Article description	Type	Qty.
Crimping tools for wire end ferrules 0.14 to 6 mm ²	PZ 6 Roto	1
Stripping tool for up to 6 mm ²	STRIPAX	1
Wire end ferrule with plastic collar, grey	H4.0/20 DS GR	500
Wire end ferrule with plastic collar, orange	H0.5/16 OR	500
Wire end ferrule with plastic collar, white	H0.75/18 W	500
Wire end ferrule with plastic collar, yellow	H1.0/18 GE	500
Wire end ferrule with plastic collar, black	H1.5/18D SW	500
Wire end ferrule with plastic collar, blue	H2.5/18D BL	500
Wire end ferrule with plastic collar, black	H6.0/20 SW	100

Technical data

length x width x height	340/270/60 mm
Weight	1760 g

Ordering data

Type	Colour code	Order No.
Crimp Set PZ 6 roto PI	Weidmüller	9203650000

Crimp-Set PZ 16 Push In



Assembly

Article description	Typ	Qty.
Crimping tools for wire end ferrules, 6 to 16 mm ²	PZ 16	1
Stripping tool for up to 6 mm ²	STRIPAX	1
Wire end ferrule with plastic collar, ivory	H10.0/22 S EB	100
Wire end ferrule with plastic collar, black	H6.0/20 SW	100
Wire end ferrule with plastic collar, ivory	H10.0/22 EB	100
Wire end ferrule with plastic collar, green	H16.0/24 GN	100

Technical data

length x width x height	340/270/60 mm
Weight	1725 g

Ordering data

Type	Colour code	Order No.
Crimp Set PZ 16 PI	Weidmüller	9203640000

Accessories – Wire end ferrules with plastic collar

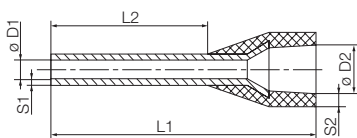

- Polypropylene conical cable entry
- Heat-resistant up to 105 °C
- Cable entry made from a not readily flammable material on request

For conductors of size 0.14-150 mm² (AWG 26-300MCM)

Material: E-Cu, tin galvanised

Dimensional tolerance acc. to DIN 46228 sect. 4

Weidmüller colour code

packed loose

Ordering data

Type	ø mm ²	AWG	L1	L2	D1	D2	S1	S2	Stripping length	Colour	Qty.	Order No.
H0.25/12	0.25	24	12.0	8.0	0.8	1.8	0.15	0.25	10.0	light blue	500	9025760000
H0.34/12	0.34	22	12.0	8.0	0.8	2.0	0.15	0.25	10.0	turquoise	500	9025770000
H0.5/14	0.50	20	14.0	8.0	1.0	2.6	0.15	0.25	10.0	orange	500	0690700000
H0.5/16	0.50	20	16.0	10.0	1.0	2.6	0.15	0.25	12.0	orange	500	9025870000
H0.75/14	0.75	18	14.0	8.0	1.2	2.8	0.15	0.25	10.0	white	500	0462900000
H0.75/16	0.75	18	16.0	10.0	1.2	2.8	0.15	0.25	12.0	white	500	9025860000
H0.75/18	0.75	18	18.0	12.0	1.2	2.8	0.15	0.25	14.0	white	500	9025910000
H1.0/14	1.00	17	14.0	8.0	1.4	3.0	0.15	0.25	10.0	yellow	500	0463000000
H1.0/16	1.00	17	16.0	10.0	1.4	3.0	0.15	0.25	12.0	yellow	500	9025950000
H1.0/18	1.00	17	18.0	12.0	1.4	3.0	0.15	0.25	15.0	yellow	500	9025930000
H1.5/14	1.50	16	14.0	8.0	1.7	3.5	0.15	0.25	10.0	red	500	0463100000
H1.5/16	1.50	16	16.0	10.0	1.7	3.5	0.15	0.25	12.0	red	500	0635100000
H2.5/14D	2.50	14	14.0	8.0	2.2	4.2	0.15	0.25	10.0	blue	500	9019160000
H2.5/18D	2.50	14	18.0	12.0	2.2	4.2	0.15	0.25	14.0	blue	500	9019170000
H4.0/20 DS	4.00	12	20.0	12.0	2.8	4.8	0.2	0.3	15.0	grey	500	9203630000
H6.0/20	6.00	10	20.0	12.0	3.5	6.3	0.2	0.3	14.0	black	100	0533500000
H 10.0/22 S	10.00	7	22.0	12.0	4.6	7.1	0.2	0.4	14.0	ivory	100	9203620000
H16.0/24	16.00	6	24.0	12.0	5.8	8.8	0.2	0.4	15.0	green	100	0565900000

Weidmüller colour code

in multi-pack bag

Ordering data

Type	ø mm ²	AWG	L1	L2	D1	D2	S1	S2	Stripping length	Colour	Qty.	Order No.
H0.14/12	0.14	26	12.0	8.0	0.6	1.5	0.15	0.25	10.0	grey	500	9028240000
H0.25/12	0.25	24	12.0	8.0	0.8	1.8	0.15	0.25	10.0	light blue	500	9025780000
H0.34/12	0.34	22	12.0	8.0	0.8	2.0	0.15	0.25	10.0	turquoise	500	9025790000
H0.5/14	0.50	20	14.0	8.0	1.0	2.6	0.15	0.25	10.0	orange	500	9026060000
H0.5/16	0.50	20	16.0	10.0	1.0	2.6	0.15	0.25	12.0	orange	500	9028270000
H0.75/14	0.75	18	14.0	8.0	1.2	2.8	0.15	0.25	10.0	white	500	9026070000
H0.75/16	0.75	18	16.0	10.0	1.2	2.8	0.15	0.25	12.0	white	500	9028290000
H0.75/18	0.75	18	18.0	12.0	1.2	2.8	0.15	0.25	14.0	white	500	9028300000
H1.0/16	1.00	17	16.0	10.0	1.4	3.0	0.15	0.25	12.0	yellow	500	9028320000
H1.0/18	1.00	17	18.0	12.0	1.4	3.0	0.15	0.25	15.0	yellow	500	9028340000
H1.5/16	1.50	16	16.0	10.0	1.7	3.5	0.15	0.25	12.0	red	500	9028350000

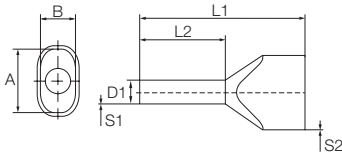

- Polypropylene conical cable entry
- Heat-resistant up to 105 °C
- Cable entry made from a not readily flammable material on request

For conductors each at 2 x 0.5 – 2 x 16 mm² (2 x AWG 20 – 2 x AWG 6)
 Material: E-Cu, tin galvanised
 Dimensional tolerance acc. to DIN 46228 sect. 4

Weidmüller colour code

packed loose

Type
 PDU. PPE. PDK. PTR



Ordering data

Type	ø mm ²	AWG	L1	L2	D1	D2	S1	S2	Stripping length	Colour	Qty.	Order No.
H0.5/15	0.50	20	15.0	8.0	1.4		0.15	0.3	11.0	● orange	500	9037200000
H0.5/16.5	0.50	20	16.0	10.0	1.4		0.15	0.3	13.0	● orange	500	9037210000
H0.5/18.5	0.50	20	19.0	12.0	1.4		0.15	0.3	15.0	● orange	500	9037220000
*H0.75/15	0.75	18	15.0	8.0	1.7		0.15	0.3	11.0	○ white	500	9037230000
*H0.75/17	0.75	18	17.0	10.0	1.7		0.15	0.3	13.0	○ white	500	9037240000
*H0.75/19S	0.75	18	19.0	12.0	1.4		0.15	0.3	21.0	○ white	500	9202820000
*H0.75/24.5	0.75	18	24.0	18.0	1.7		0.15	0.3	21.0	○ white	500	9037250000
*H1.0/25.6	1.00	17	25.0	18.0	2.0		0.15	0.3	22.0	● yellow	500	9037280000
*H1.5/25.6	1.50	16	26.0	18.0	2.2		0.15	0.3	21.0	● red	100	9037310000
**H2.5/26.5D	2.50	14	27.0	18.0	2.8		0.15	0.4	21.0	● blue	100	9037520000

Note: * Voltage reduced to 320 V ** Voltage reduced to 160 V

Weidmüller colour code

packed loose

Type
 PDL DU/PE



Ordering data

Type	ø mm ²	AWG	L1	L2	D1	D2	S1	S2	Stripping length	Colour	Qty.	Order No.
H0.5/15	0.50	20	15.0	8.0	1.4		0.15	0.3	11.0	● orange	500	9037200000
H0.5/16.5	0.50	20	16.0	10.0	1.4		0.15	0.3	13.0	● orange	500	9037210000
H0.5/18.5	0.50	20	19.0	12.0	1.4		0.15	0.3	15.0	● orange	500	9037220000
H0.75/15	0.75	18	15.0	8.0	1.7		0.15	0.3	11.0	○ white	500	9037230000
H0.75/17	0.75	18	17.0	10.0	1.7		0.15	0.3	13.0	○ white	500	9037240000
H0.75/19S	0.75	18	19.0	12.0	1.4		0.15	0.3	21.0	○ white	500	9202820000
H0.75/24.5	0.75	18	24.0	18.0	1.7		0.15	0.3	21.0	○ white	500	9037250000
H1.0/25.6	1.00	17	25.0	18.0	2.0		0.15	0.3	22.0	● yellow	500	9037280000
H1.5/25.6	1.50	16	26.0	18.0	2.2		0.15	0.3	21.0	● red	100	9037310000
H2.5/26.5D	2.50	14	27.0	18.0	2.8		0.15	0.4	21.0	● blue	100	9037520000

