

Accessories and Modification Codes

Side-Mounted Auxiliary Contact

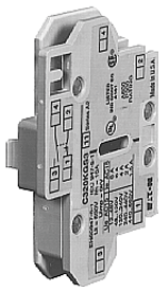

Auxiliary Contact



Type 1 Enclosure



Electrically Held Base Contactor



Surge Suppressor



15.1 Accessories

| | |
|---|------------|
| Freedom NEMA | V10-T15-2 |
| A200 NEMA | V10-T15-18 |
| XT IEC | V10-T15-23 |
| Enclosures | V10-T15-28 |
| Lighting Contactors | V10-T15-30 |
| IT Solid-State Soft Starters | V10-T15-36 |

15.2 Modification Codes

| | |
|--------------------------|------------|
| Modification Codes | V10-T15-39 |
|--------------------------|------------|

Freedom NEMA

Auxiliary Contacts

NEMA Sizes 00–2

The auxiliary contacts listed below are designed for installation on Freedom Series starters and contactors. Snap-on design facilitates quick, easy installation.

These bifurcated design contact blocks, featuring silver cadmium alloy contacts, are well suited for use in very low energy (logic level) circuits.

Product Selection

Side-Mounted

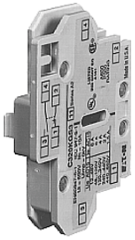

Top-Mounted



| Description | Contact Configuration Code ^① | Catalog Number |
|---------------------------|---|----------------|
| Side-Mounted | | |
| 1NO | 10 | C320KGS1 |
| 1NC | 01 | C320KGS2 |
| 1NO-1NC | 11 | C320KGS3 |
| 2NO | 20 | C320KGS4 |
| 2NC | 02 | C320KGS5 |
| 1NO-1NCI | N/A | C320KGS6 |
| 1NO (EC)-1NC (LO) | N/A | C320KGS7 |
| 1NCI | N/A | C320KGS8 |
| Top-Mounted | | |
| 1NO | 10 | C320KGT1 |
| 1NC | 01 | C320KGT2 |
| 1NO-1NC | 11 | C320KGT3 |
| 2NO | 20 | C320KGT4 |
| 2NC | 02 | C320KGT5 |
| 1NO-1NCI | N/A | C320KGT6 |
| 1NO (EC)-1NC (LO) | N/A | C320KGT7 |
| 1NCI | N/A | C320KGT8 |
| 3NO | 30 | C320KGT9 |
| 2NO-1NC | 21 | C320KGT10 |
| 1NO-2NC | 12 | C320KGT11 |
| 3NC | 03 | C320KGT12 |
| 4NO | 40 | C320KGT13 |
| 3NO-1NC | 31 | C320KGT14 |
| 2NO-2NC | 22 | C320KGT15 |
| 1NO-3NC | 13 | C320KGT16 |
| 4NC | 04 | C320KGT17 |
| 3NO-1NCI | N/A | C320KGT18 |
| 2NO-1NCI-1NC | N/A | C320KGT19 |
| 2NO-1NO (EC)-1NC (LO) | N/A | C320KGT20 |
| 1NO-1NC-1NO (EC)-1NC (LO) | N/A | C320KGT21 |

Notes

NCI = Normally Closed early opening designed for use in reversing applications. EC = Early Closing. LO = Late Opening.

^① For reference only—not part of catalog number. See **Page V10-T15-3**.

Contact Configuration Code

This two-digit code is found on the auxiliary contact to assist in identifying the specific contact configuration.

The first digit indicates the quantity of NO contacts and the second indicates the quantity of NC contacts.

NEMA Sizes 3–8

Product Selection

| Circuit | Contact Configuration Code ^① | NEMA Size | Catalog Number |
|---|---|-----------|------------------|
| Base Auxiliary Contact | | | |
| Base Auxiliary Contacts—NEMA Sizes 3–5 | | | |
| NO | 10 | 3 | C320KGS31 |
| NO-NC | 11 | 3 | C320KGS32 |
| NO | 10 | 4–5 | C320KGS42 |
| NO-NC | 11 | 4–5 | C320KGS42 |
| Auxiliary Contact | | | |
| Auxiliary Contacts—NEMA Sizes 3–5 | | | |
| NO | 10 | 3–5 | C320KGS20 |
| NC | 01 | 3–5 | C320KGS21 |
| NO-NC ^② | 11 | 3–5 | C320KGS22 |
| Auxiliary Contacts—NEMA Sizes 6–8 | | | |
| NO-NC | 11 | 8 | C320KA5 |
| 2NO-2NC | 22 | 6–7 | C320KA6 |

Auxiliary Contact Ratings (Amperes)

Ratings—NEMA A600

| Current | AC Volts | | | |
|-----------------------|----------|------|------|------|
| | 120V | 240V | 480V | 600V |
| Make and interrupting | 60 | 30 | 15 | 12 |
| Break | 6 | 3 | 1.5 | 1 |
| Continuous | 10 | 10 | 10 | 10 |

Ratings—NEMA P300

| DC Volts | Make/Break Amperes |
|--------------------------------------|--------------------|
| Continuous Thermal Rating: 5A | |
| 125 | 1.10 |
| 250 | 0.55 |

Ratings—Logic Level

| Current | Rating |
|---|------------|
| Minimum Ratings for Logic Level and Hostile Atmosphere Application | |
| Minimum amperes | 20 mA |
| Minimum volts | 24 Vac/Vdc |

Ratings—C320KGS20L, C320KGS21L, C320KGS22L

| DC-12 | | AC-12 | |
|----------------|----------------|----------------|----------------|
| U _e | I _e | U _e | I _e |
| 80 | 0.1 | 250 | 0.1 |

Notes

^① For reference only—not part of catalog number. See above.

^② NO-NC occupies two positions—L2 and L3, or R2 and R3. See **Page V10-T15-5**.

15.1

Accessories and Modification Codes

Accessories

Auxiliary Contact Location

NEMA Sizes 00–2

The sketches below illustrate the maximum number of auxiliary contacts that can be

assembled to a contactor or starter and their locations.

Auxiliary Contacts

| Size | Poles | Available Mounting Positions ①② | | Catalog Number |
|--------|-------|---------------------------------|----------|----------------|
| | | Open Type | Enclosed | |
| 00 | 3 | T1, L1, R1 | L1 | AN16 |
| 0–2 | 3 | T1, L1 | L1 | |
| 00–2 | 3 | T1, T2 | — | AN56 |
| 00 | 2–4 | T1, L1, R1 | L1 | CN15 |
| 0–2 | 2–3 | T1, L1 | L1 | |
| 1, 2 | 4 | T1, L1 | — | |
| 1, 2 | 5 | T1, L1 | — | |
| 10A | 2–4 | T1, L1, R1 | L1 | CN35 |
| 20–60A | 2–3 | T1, L1 | L1 | |
| 60A | 4 | T1, L1 | — | |
| 60A | 5 | T1, L1 | — | |
| 00–2 | 3 | T1, T2 | — | CN55 |

Auxiliary Contact Location

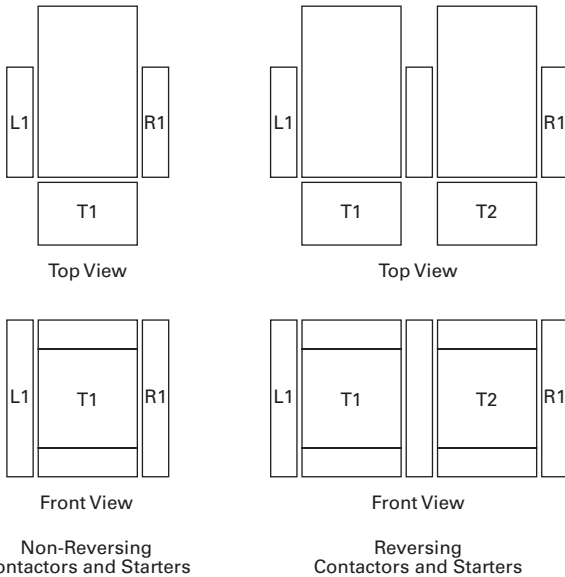

Notes

- ① Available positions on contactors or starters other than what is factory installed.
- ② When a pneumatic timer is mounted on contactor, only side-mounted auxiliary contact positions are available. The solid-state timer, when added, takes up side-mounted auxiliary contact position.

NEMA Sizes 3–8

The sketches below illustrate the maximum number of auxiliary contacts that can be assembled to a contactor and their locations.

Note: A base auxiliary contact must be added in position R1 before additional auxiliary contacts can be mounted on NEMA Size 3 or in L1 on NEMA Sizes 4–5.

Mounting Positions

| Size | Available Mounting Positions ^① |
|----------------|---|
| NEMA Size 3 | R2, R3, L1, L2, L3 |
| NEMA Sizes 4–5 | L2, L3, R1, R2, R3 |
| NEMA Sizes 6–7 | R1 |
| NEMA Size 8 | L2, R2 |

Auxiliary Contact Location

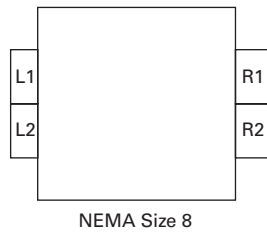
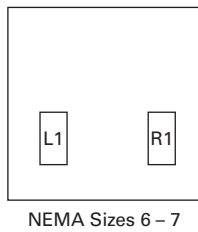
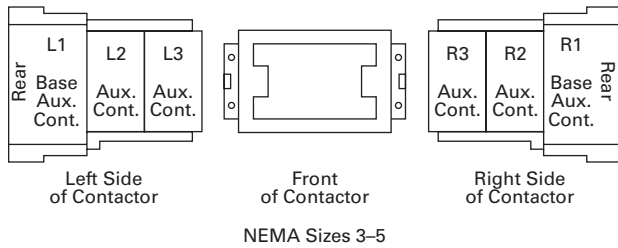

Note

① Available positions on contactors or starters other than what is factory installed.

Heater Pack Selection

Heater packs H2001B to H2017B and H2101B to H2117B are to be used only with Series B overload relays Catalog Numbers C306DN3B (Part No. 10-7016) and C306GN3B (Part No. 10-7020). The load lugs are built into the overload relay base to allow load wiring prior to heater pack installation. The

previous heater design had integral load lugs. The Series B heater packs are electrically equivalent to the previous heater design. Heaters H2018-3 to H2024-3 have not changed.

Note: The series of a starter is the last digit of the listed catalog number. Example: AN16DN0A**B**.

Starters with Series B Overload Relays

| Size | Series |
|---------------------|----------|
| NEMA—AN Type | |
| 00–0 | C |
| 1–2 | B |
| 5 | B |
| 6 | C |
| 7–8 | B |

Fast Trip—Class 10 Heater Selection

| Overload Relay Size | Motor Full Load Ampere Rating Dial Position | | | | Catalog Number (Includes Three Heater Packs) ① |
|---|---|-------|-------|-------|--|
| | A | B | C | D | |
| For Use with NEMA Sizes 00–0 Series C, NEMA Sizes 1–2 Series B | | | | | |
| 32A or 75A | 0.260 | 0.313 | 0.367 | 0.420 | H2101B-3 |
| | 0.384 | 0.464 | 0.543 | 0.623 | H2102B-3 |
| | 0.570 | 0.688 | 0.806 | 0.924 | H2103B-3 |
| | 0.846 | 1.02 | 1.20 | 1.37 | H2104B-3 |
| | 1.28 | 1.55 | 1.83 | 2.10 | H2105B-3 |
| | 1.92 | 2.33 | 2.74 | 3.15 | H2106B-3 |
| | 2.30 | 2.79 | 3.28 | 3.77 | H2107B-3 |
| | 3.38 | 4.10 | 4.82 | 5.54 | H2108B-3 |
| | 7.07 | 6.03 | 7.09 | 8.16 | H2109B-3 |
| | 7.07 | 8.58 | 10.1 | 11.6 | H2110B-3 |
| | 9.60 | 11.2 | 12.8 | 14.4 | H2111B-3 |
| | 14.4 | 17.5 | 20.7 | 23.8 | H2112B-3 |
| | 18.7 | 21.8 | 25.0 | 28.1 | H2113B-3 |
| | 23.5 | 27.3 | 31.0 | 34.8 | H2114B-3 |
| For Use with NEMA Size 2—Series B | | | | | |
| 75A | 28.3 | 32.6 | 37.0 | 41.3 | H2115B-3 |
| | 36.6 | 42.3 | 48.1 | 53.8 | H2116B-3 |
| | 53.8 | 60.8 | 67.9 | 74.9 | H2117B-3 |
| For Use with Size 5 Starters Only—Series B | | | | | |
| 32A ② | 51 | 61 | 72 | 82 | H2104B-3 |
| | 77 | 93 | 110 | 126 | H2105B-3 |
| | 115 | 140 | 164 | 189 | H2106B-3 |
| | 138 | 167 | 197 | 226 | H2107B-3 |
| | 203 | 246 | 289 | — | H2108B-3 |
| For Use with Size 6 Starters Only—Series B | | | | | |
| 32A ② | 154 | 186 | 220 | 252 | H2105B-3 |
| | 230 | 280 | 329 | 378 | H2106B-3 |
| | 276 | 335 | 394 | 452 | H2107B-3 |
| | 406 | 492 | 578 | — | H2108B-3 |
| For Use with Size 7 Starters Only—Series B | | | | | |
| 32A ② | 169 | 204 | 240 | 274 | H2104B-3 |
| | 256 | 310 | 366 | 420 | H2105B-3 |
| | 384 | 466 | 543 | 630 | H2106B-3 |
| | 460 | 558 | 656 | 754 | H2107B-3 |
| | 676 | 820 | — | — | H2108B-3 |
| For Use with Size 8 Starters Only—Series B | | | | | |
| 32A ② | 254 | 306 | 360 | 411 | H2104B-3 |
| | 384 | 465 | 549 | 630 | H2105B-3 |
| | 576 | 699 | 822 | 945 | H2106B-3 |
| | 690 | 837 | 984 | 1131 | H2107B-3 |
| | 1014 | 1230 | — | — | H2108B-3 |

Notes

- ① Heater packs are shipped three to a carton. Catalog numbers are for three heater packs.
 ② Sizes 5–8 use the 32A overload relay with current transformers.

Standard Trip—Class 20 Heater Selection

| Overload Relay Size | Motor Full Load Ampere Rating Dial Position | | | | Catalog Number (Includes Three Heater Packs) ① |
|---|---|-------|-------|-------|--|
| | A | B | C | D | |
| For Use with NEMA Sizes 00–0 Series C, NEMA Sizes 1–2 Series B | | | | | |
| 32A or 75A | 0.254 | 0.306 | 0.359 | 0.411 | H2001B-3 |
| | 0.375 | 0.452 | 0.530 | 0.607 | H2002B-3 |
| | 0.560 | 0.676 | 0.791 | 0.907 | H2003B-3 |
| | 0.814 | 0.983 | 1.15 | 1.32 | H2004B-3 |
| | 1.20 | 1.45 | 1.71 | 1.96 | H2005B-3 |
| | 1.79 | 2.16 | 2.53 | 2.90 | H2006B-3 |
| | 2.15 | 2.60 | 3.04 | 3.49 | H2007B-3 |
| | 3.23 | 3.90 | 4.56 | 5.23 | H2008B-3 |
| | 4.55 | 5.50 | 6.45 | 7.40 | H2009B-3 |
| | 6.75 | 8.17 | 9.58 | 11.0 | H2010B-3 |
| | 9.14 | 10.8 | 12.4 | 14.0 | H2011B-3 |
| | 14.0 | 16.9 | 19.9 | 22.8 | H2012B-3 |
| | 18.7 | 22.7 | 26.7 | 30.7 | H2013B-3 |
| | 23.5 | 28.5 | 33.5 | 38.5 | H2014B-3 |
| For Use with NEMA Size 2—Series B | | | | | |
| 75A | 29.0 | 34.0 | 39.1 | 44.1 | H2015B-3 |
| | 39.6 | 45.5 | 51.5 | 57.4 | H2016B-3 |
| | 53.9 | 60.9 | 67.9 | 74.9 | H2017B-3 |
| For Use with NEMA Sizes 3–4—Series A | | | | | |
| 105A or 144A | 8.0 | 9.2 | 10.3 | 11.5 | H2025-3 |
| | 11.4 | 12.8 | 14.3 | 15.7 | H2026-3 |
| | 14.3 | 15.7 | 17.4 | 19.0 | H2027-3 |
| | 18.0 | 20.2 | 22.3 | 24.5 | H2018-3 |
| | 24.6 | 27.6 | 30.5 | 33.4 | H2019-3 |
| | 33.5 | 37.5 | 41.5 | 45.6 | H2020-3 |
| | 45.7 | 51.2 | 56.7 | 62.1 | H2021-3 |
| | 62.2 | 69.7 | 77.1 | 84.6 | H2022-3 |
| | 84.7 | 95.0 | 105.0 | 115.0 | H2023-3 |
| | 106.0 | 118.0 | 131.0 | 144.0 | H2024-3 |
| For Use with Size 5 Starters—Series B | | | | | |
| 32A ② | 49 | 59 | 69 | 79 | H2004B-3 |
| | 72 | 87 | 103 | 118 | H2005B-3 |
| | 107 | 130 | 152 | 174 | H2006B-3 |
| | 129 | 156 | 182 | 209 | H2007B-3 |
| | 194 | 234 | 274 | — | H2008B-3 |
| For Use with Size 6 Starters Only—Series B | | | | | |
| 32A ② | 144 | 174 | 205 | 235 | H2005B-3 |
| | 215 | 259 | 304 | 348 | H2006B-3 |
| | 258 | 312 | 365 | 419 | H2007B-3 |
| | 388 | 468 | 547 | 627 | H2008B-3 |
| For Use with Size 7 Starters Only—Series B | | | | | |
| 32A ② | 163 | 197 | 230 | 264 | H2004B-3 |
| | 240 | 290 | 342 | 392 | H2005B-3 |
| | 358 | 432 | 506 | 580 | H2006B-3 |
| | 430 | 520 | 608 | 698 | H2007B-3 |
| | 646 | 780 | 912 | — | H2008B-3 |
| For Use with Size 8 Starters Only—Series B | | | | | |
| 32A ② | 244 | 295 | 345 | 396 | H2004B-3 |
| | 360 | 435 | 513 | 588 | H2005B-3 |
| | 537 | 648 | 759 | 870 | H2006B-3 |
| | 645 | 780 | 912 | 1047 | H2007B-3 |
| | 969 | 1170 | 1368 | — | H2008B-3 |

Notes

① Heater packs are shipped three to a carton. Catalog numbers are for three heater packs.

② Sizes 5–8 use the 32A overload relay with current transformers.

DC Magnet Coils

When Ordering Specify

Conversion Kit for Field Assembly

- Catalog number

Factory Installed DC Coil

- For factory installed DC magnet coil on AC contactors or non-combination starters (open type only), substitute the code suffix from table below for the magnet coil identifier in the device catalog number.

Example: For Size 0 AC contactor with a 24 Vdc coil, change CN15BN3AC to CN15BN3T1C

Application

- Connect for separate control
- Not for use with cover control switch operators
- Use twin break, heavy-duty pilot devices
- Designed for +10%, -20% rated voltage, continuous duty operation

Non-Reversing Kit Consists of:

- One encapsulated DC magnet coil
 - One NCI or NO/NCI side-mounted auxiliary contact
- Note:** These kits are supplied with a NO/NCI side-mounted auxiliary contact in place of the NCI contact.
- Two blue colored connection wires
 - One instruction publication

Operation

These DC coil kits have separate pickup and seal windings. A **special** (side-mounted) early-break NCI auxiliary contact is used to either disconnect the pickup winding or insert the seal winding in series with the pickup winding, depending on the frame size of the contactor. DC coil kits come in two styles, a suffix **1** and a suffix **4**. The 1 suffix contains only the **special** (side-mounted) early break NCI auxiliary contact. The 4 suffix contains a NO contact in the same package as the **special** (side-mounted) early-break NCI auxiliary contact.

Note: NEMA Sizes 00 and 0 contactors may use either suffix 1 or 4 DC coil kits; starters

may use suffix 4 DC coil kits only. For NEMA Sizes 1 and 2, both contactors and starters may use a suffix 4 DC coil kit only.

On the above sizes only, when the **special** auxiliary package is mounted on the side of a contactor or starter, **no** standard auxiliary contact may be mounted on the same side.

Note: For NEMA Sizes 3–5, the special coil NCI clearing contact is an add-on auxiliary (**must** mount on a base mount auxiliary contact; normally a 1NO). This arrangement will normally account for two of the three contact positions on the side of each contactor or starter.

See figure on **Page V10-T15-9**.

Product Selection

| Contactor or Starter Size | Conversion Data | | | | NCI Interlock Number | Factory Installed Code Suffix | Complete Conversion Kit | |
|--|-----------------|----------------------------|-------------------|--------------------|----------------------|-------------------------------|-------------------------|------------------|
| | Volts | Magnet Coil Coil Number | Amps P.U./Seal | Watts P.U./Seal | | | Ship Wt. Lbs (kg) | Catalog Number |
| NEMA | | | | | | | | |
| Non-Reversing — Kit includes NCI Side-Mounted Auxiliary Contact | | | | | | | | |
| 00 and 0 CN35-A, B, D D15 relays | 12 | 9-2988-11 | 6.4/0.28 | 76.8/3.36 | C320KGD1 | R1 | 1.0 (0.5) | C335KD3R1 |
| | 24 | 9-2988-12 | 3.2/0.14 | 76.8/3.36 | C320KGD1 | T1 | | C335KD3T1 |
| | 48 | 9-2988-13 | 1.6/0.07 | 76.8/3.36 | C320KGD1 | W1 | | C335KD3W1 |
| | 120 | 9-2988-14 | 0.64/0.028 | 76.8/3.36 | C320KGD1 | A1 | | C335KD3A1 |
| ① 00 and 0 CN35-A, B, D D15 relays | 12 | 9-2988-11 | 6.4/0.28 | 76.8/3.36 | C320KGD2 ① | R4 | 1.0 (0.5) | C335KD3R4 |
| | 24 | 9-2988-12 | 3.2/0.14 | 76.8/3.36 | C320KGD2 ① | T4 | | C335KD3T4 |
| | 48 | 9-2988-13 | 1.6/0.07 | 76.8/3.36 | C320KGD2 ① | W4 | | C335KD3W4 |
| | 120 | 9-2988-14 | 0.64/0.028 | 76.8/3.36 | C320KGD2 ① | A4 | | C335KD3A4 |
| 1 and 2 CN35-G | 12 | 9-2990-1 | 15.4/0.42 | 185/4.98 | C320KGD5 | R4 | 1.0 (0.5) | C335KD4R4 |
| | 24 | 9-2990-2 | 7.7/0.21 | 185/4.96 | C320KGD5 | T4 | | C335KD4T4 |
| | 48 | 9-2990-3 | 3.9/0.11 | 185/5.04 | C320KGD5 | W4 | | C335KD4W4 |
| | 120 | 9-2990-4 | 1.5/0.041 | 185/4.87 | C320KGD5 | A4 | | C335KD4A4 |
| 3 CN35-K | 12 | 9-3002-1 | 24/0.40 | 293/4.84 | C320KGD3 | R1 | 2.0 (0.9) | C335KD5R1 |
| | 24 | 9-3002-2 | 12/0.20 | 288/4.75 | C320KGD3 | T1 | | C335KD5T1 |
| | 48 | 9-3002-3 | 6.1/0.097 | 295/4.67 | C320KGD3 | W1 | | C335KD5W1 |
| | 120 | 9-3002-4 | 2.5/0.038 | 298/4.57 | C320KGD3 | A1 | | C335KD5A1 |
| 4 and 5 CN35-N, S | 24 | 9-2026-4 | 18/0.22 | 400/5.3 | C320KGD3 | T1B | 2.5 (1.1) | C335KA3T1 |
| | 48 | 9-2026-3 | 9/0.11 | 400/5.2 | C320KGD3 | W1B | | C335KA3W1 |
| | 120 | 9-2026-2 | 3.3/0.05 | 450/5.4 | C320KGD3 | A1B | | C335KA3A1 |
| | 240 | 9-2026-1 | 1.7/0.02 | 440/4.9 | C320KGD3 | B1B | | C335KA3B1 |

Note

① These kits are supplied with a NO/NCI side-mounted auxiliary contact in place of the NCI contact.

Product Selection, continued

| Contactor or Starter Size | Conversion Data | | | | NCI Interlock Number | Factory Installed Code Suffix | Complete Conversion Kit | |
|--|-----------------|----------------------------|-------------------|--------------------|----------------------|-------------------------------|-------------------------|----------------|
| | Volts | Magnet Coil Coil Number | Amps P.U./Seal | Watts P.U./Seal | | | Ship Wt. Lbs (kg) | Catalog Number |
| NEMA | Volts | Coil Number | Amps P.U./Seal | Watts P.U./Seal | NCI Interlock Number | Factory Installed Code Suffix | Ship Wt. Lbs (kg) | Catalog Number |
| Reversing | | | | | | | | |
| 00 and 0 CN35-A, B, D D15 relays | 12 | 9-2988-1 | 6.4/0.28 | 76.8/3.36 | C320KGD1 | R1 ① | 1.0 (0.9) | C335KD3R1 ② |
| | 24 | 9-2988-2 | 3.2/0.14 | 76.8/3.36 | C320KGD1 | T1 ① | | C335KD3T1 ② |
| | 48 | 9-2988-3 | 1.6/0.07 | 76.8/3.36 | C320KGD1 | W1 ① | | C335KD3W1 ② |
| | 120 | 9-2988-4 | 0.64/0.028 | 76.8/3.36 | C320KGD1 | A1 ① | | C335KD3A1 ② |
| 1 and 2 CN35-G | 12 | 9-2990-1 | 15.4/0.42 | 185/4.98 | C320KGD3 | R1 ① | — | ③ |
| | 24 | 9-2990-2 | 7.7/0.21 | 185/4.96 | C320KGD3 | T1 ① | | ③ |
| | 48 | 9-2990-3 | 3.9/0.11 | 185/5.04 | C320KGD3 | W1 ① | | ③ |
| | 120 | 9-2990-4 | 1.5/0.041 | 185/4.87 | C320KGD3 | A1 ① | | ③ |

Elementary Diagrams

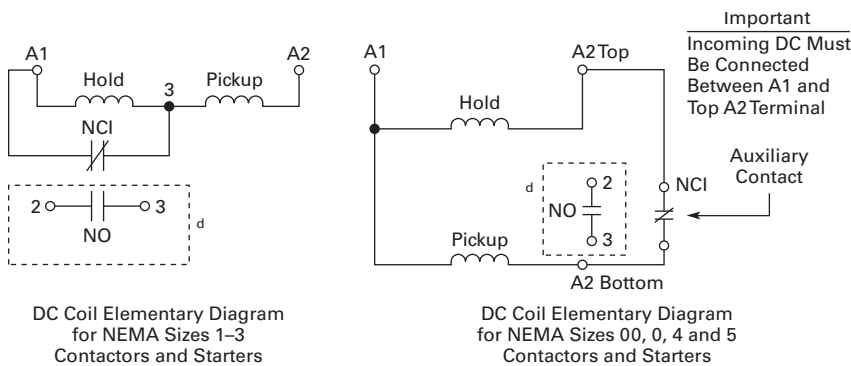

Notes

- ① Factory installed DC coils on NEMA contactors and starters include a NO/NC top-mounted auxiliary contact on each contactor for electrical interlocking.
- ② Kit does not include mechanical interlock or crossover wiring. Two NO/NCI top-mounted auxiliary contacts are supplied for electrical interlocking.
- ③ Available factory assembled only.
- ④ 1NO available in suffix 4 kits only.

15.1 Accessories and Modification Codes

Accessories

Remote Reset Module (32A Overload Relay)

The C316RR remote reset module for the C316F, C316S and C316U overload relays allows remote resetting of tripped (32A) overload relays by means of an electrical solenoid attachment that mounts on the side of the overload relay.

Product Selection

| Remote Reset Module Operating Voltage | Catalog Number |
|---------------------------------------|----------------|
| 24V 50/60 Hz | C316RR1U |
| 110V 50/60 Hz | C316RR1A |

Dimensions

Approximate Dimensions in Inches (mm)

Note: The operating coil is not suitable for a continuous duty. Recommended impulse duration 0.2–0.35 seconds with 15 operations maximum per hour.

Remote Reset Module

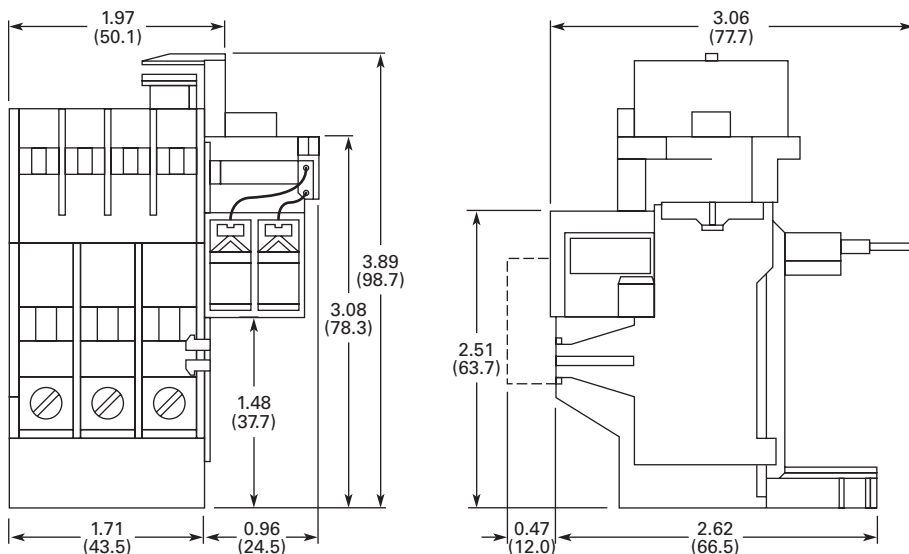

Three-Pole Top-Mounted Fuse Block Kit

NEMA Sizes 00–2

Field mount to Freedom Series starters and contactors. Designed to save space and reduce installation costs. They provide short-circuit protection for branch circuits.

Mounted Fuse Block Kit

Fuse Block Kit

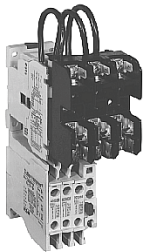

Fuse Block Kits

| Fuse Type | Catalog Number | Fuse Type | Catalog Number |
|--------------------|-----------------|---------------------|-----------------|
| Class H — 30A 250V | C350KH21 | Class T — 60A 300V | C350KT32 |
| Class R — 30A 250V | C350KR21 | Class J — 30A 600V | C350KJ61 |
| Class G — 15A 300V | C350KG37 | Class J — 60A 600V | C350KJ62 |
| Class G — 20A 300V | C350KG38 | Type M — 30A 600V ① | C350KM61 |
| Class G — 30A 300V | C350KG31 | Class CC — 30A 600V | C350KC63 |
| Class G — 60A 300V | C350KG32 | Class T — 30A 600V | C350KT61 |
| Class T — 30A 300V | C350KT31 | Class T — 60A 600V | C350KT62 |

Dimensions

Approximate Dimensions in Inches (mm)

Mounted Fuse Block

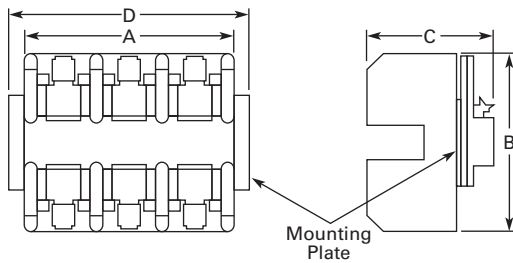

Fuse Block

| Class | Amperes | Volts | Wide A | High B | Deep C | D |
|-------|------------|-------|--------------|--------------|-------------|-------------|
| G | 15, 20, 30 | 300 | 2.40 (61.0) | 3.00 (76.2) | 2.04 (51.8) | — |
| | 60 | 300 | 2.62 (66.5) | 4.25 (108.0) | 2.08 (52.8) | — |
| H | 30 | 250 | 3.00 (76.2) | 3.10 (78.7) | 2.23 (56.6) | 3.62 (91.9) |
| J | 30, 60 | 600 | 4.81 (122.2) | 4.12 (104.6) | 2.82 (71.6) | — |
| M, CC | 30 | 600 | 2.40 (61.0) | 3.00 (76.2) | 2.04 (51.8) | — |
| R | 30 | 250 | 3.00 (76.2) | 3.10 (78.7) | 2.23 (56.6) | 3.62 (91.9) |
| T | 30, 60 | 300 | 3.44 (87.4) | 3.00 (76.2) | 2.33 (59.2) | — |
| | 30 | 600 | 3.75 (95.3) | 3.31 (84.1) | 2.26 (57.4) | — |
| | 60 | 600 | 4.87 (123.7) | 3.00 (76.2) | 2.58 (65.5) | — |

Note

① Type M fuse block not approved for branch circuit protection.

Mechanical Interlock and Reversing Kits

Mechanical interlocks and reversing kits are designed for field assembly of reversing contactors or starters from Freedom Series components. The reversing kits include a mechanical

interlock, stabilizer bar and a pre-cut, trimmed and formed wire set. Auxiliary contacts, if required, must be ordered separately. See **Page V10-T15-2**.

Mechanical Interlock



Mechanical Interlock Only ①②

| Application | | |
|-------------|---------------------|----------------|
| NEMA Size | Contactors Mounting | Catalog Number |
| 00-2 | Horizontal | C321KM60B |
| 3 | Horizontal | C321KM30 |
| 3 to 4 | Horizontal | C321KM43 |
| 4 | Horizontal | C321KM40 |
| 4 to 5 | Horizontal | C321KM45 |
| 4 to 6 | Horizontal | C321KM80 |
| 5 | Horizontal | C321KM50 |
| 5 to 6 | Horizontal | C321KM56 |
| 6 | Horizontal | C321KM70 |
| 6 to 7 | Horizontal | C321KM90 |
| 7 | Horizontal | C321KM34 |
| 4 or 5 to 6 | Vertical | C321KM55 |
| 5 to 6 | Vertical | C321KM65 |
| 6 | Vertical | C321KM66 |
| 6 to 7 | Vertical | C321KM67 |

Reversing Kits (Horizontal Contactor Mounting Only)

| Application | | Application | |
|-------------|----------------|-------------|----------------|
| NEMA Size | Catalog Number | NEMA Size | Catalog Number |
| 00 | C321KM60K14B | — | C321KM60K21 ③ |
| 0 | C321KM60K13B | — | C321KM60K18 ③ |
| 1 | C321KM60K15B | 4 | C321KM60K19 ③ |
| 2 | C321KM60K16B | 5 | C321KM60K20 ③ |
| 3 | C321KM60K17 ③ | — | C321KM60K44 ③ |

Solid-State Timers

Solid-State ON DELAY Timer—Side-Mounted on Freedom Series NEMA 00-2 and C25D, C25E and C25F Frame

This timer is designed to be **wired in series with the load** (typically a coil). When the START button is pushed (power applied to timer), the

ON DELAY timing function starts. At the completion of the set timing period, timer and series wired load will both be energized.

Solid-State Timer



Mounted Timer Product Selection

| Timing Range | Catalog Number ④⑤⑥ |
|-----------------|--------------------|
| 0.1-1.0 seconds | C320TDN1_ |
| 1-30 seconds | C320TDN30_ |
| 30-300 seconds | C320TDN300_ |
| 5-30 minutes | C320TDN2000_ |

Pneumatic Timers—Top-Mounted

Attachment mounts on top of any NEMA Size 00-2 Freedom Series starter or contactor (top-mounted auxiliary contacts can not be installed on device when timer

is used). Timer unit has 1NO-1NC isolated timed contacts—circuits in each pole must be the same polarity. Units are convertible from OFF to ON DELAY or vice-versa.

Pneumatic Timer



Product Selection

| Timing Range | Catalog Number |
|----------------|----------------|
| 0.1-30 seconds | C320TP1 |
| 10-180 seconds | C320TP2 |

Maximum Ampere Ratings

| Description | Volts AC | | | |
|-------------|----------|-----|------|-----|
| | 120 | 240 | 480 | 600 |
| Make | 30 | 15 | 7.5 | 6 |
| Break | 3 | 1.5 | 0.75 | 0.6 |

Notes

- ① Without cross-wiring.
- ② For use with latest series product.
- ③ Kit includes two NC auxiliary contacts.
- ④ Add operating voltage suffix to catalog number. **A** = 120V, **B** = 240V, **E** = 208V.
- ⑤ Rated 0.5A pilot duty—not to be used on larger contactors.
- ⑥ Terminal connections are quick connects only. Two per side.

Locking Cover for Overload Relay—C306 Only

Snap-on transparent or opaque plastic panel for covering access port to the overload relay trip setting

dial—helps prevent accidental or unauthorized changes to trip and reset setting.

Locking Cover



Product Selection

| Description | Minimum Ordering Qty. (Std. Pkg.) | Catalog Number |
|--|-----------------------------------|----------------|
| Clear cover, no accessibility | 50 | C320PC3 |
| Gray cover, no accessibility, with auto only nib | 50 | C320PC4 |
| Gray cover, no accessibility, with manual only nib | 50 | C320PC5 |
| Gray cover with FLA dial accessibility, A, B, C, D positions and auto only nib | 50 | C320PC6 |
| Gray cover with FLA dial accessibility, A, B, C, D positions and manual only nib | 50 | C320PC7 |

Control Circuit Fuse Block

These panel mounted fuse holders, designed for control circuit protection or other similar low current requirements, have extractor type fuse caps. The Class CC rejection type fuses (KTK-R) used in these holders are intended for use with

equipment designated as being suitable for use on systems having high available fault currents. If branch circuit protective device is 45A or greater, C320FBR fuse kit may be required for control circuit protection per NEC 430-72.

Control Circuit Fuse Block



Product Selection

| Type | Maximum Amperes | Catalog Number |
|------------------|-----------------|------------------|
| Fuse holder only | 15 | C320FB ① |
| | 30 | C320FBR ② |

Dimensions

Approximate Dimensions in Inches (mm)

Control Circuit Fuse Block

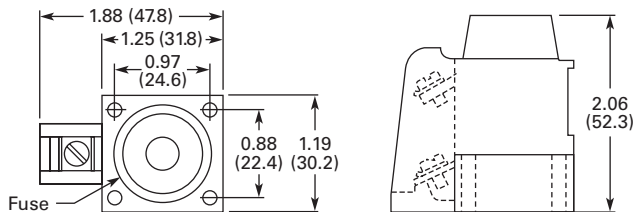

Transient Suppressor Kits

NEMA Sizes 00–2

These kits limit high voltage transients produced in the control circuit when power is removed from the contactor or starter coil. There are three separate suppressors for use on 24–120V, 208–240V or 277–480V coils respectively.

These devices mount directly to the coil terminals of Freedom Series contactors or starters NEMA Sizes 00–2 and lighting contactors 10–60A. Reversing devices will require two.

Transient Suppressor NEMA Sizes 00–2



Product Selection

| Description | Coil Voltage 50/60 Hz ③ | Catalog Number |
|----------------------|-------------------------|----------------|
| Transient suppressor | 24–120V | C320TS1 |
| | 208–240V | C320TS2 |
| | 277–480V | C320TS3 |

NEMA Sizes 3–5

This device mounts on top of any side-mounted auxiliary contact on Freedom Series NEMA Sizes 3–5 and lighting contactors 100–300A. It connects across coil terminals on any 120V contactor or starter magnet

coil (reversing starters or contactors require 2).

Limits high voltage transients produced in the circuit when power is removed from the coil.

Transient Suppressor NEMA Sizes 3–5



Product Selection

| Description | Coil Voltage | Catalog Number |
|----------------------|--------------|----------------|
| Transient suppressor | 120V | C320AS1 |

Shorting Bar Kits

These kits provide phase-to-phase power connections of contactors for field assembly. The kits include bus

connections and mounting hardware. The shorting bars connect all three phases of a single contactor.

Product Selection

| Description | Catalog Number | Description | Catalog Number |
|-------------|-----------------|-------------|-----------------|
| NEMA Size 3 | C321SB18 | NEMA Size 5 | C321SB21 |
| NEMA Size 4 | C321SB19 | NEMA Size 6 | C321SB22 |

Notes

- ① A fuse is not supplied, but holder will accept a Bussman Type KTK or KTK-R (13/32 in x 1-1/2 in) fuse, 600V maximum.
- ② Includes a 5A, 600V KTK-R fuse.
- ③ Suppressor is compatible with coil voltages/ranges as shown, 50 and 60 Hz.

15.1

Accessories and Modification Codes

Accessories

DC/AC Interface Module

The catalog number C320DC Interface Module is an optically isolated solid-state switch which provides a means of operating AC coils with 5–48 Vdc control signal. It acts as a space saving interposing relay which can switch a specified 50/60 Hz AC source to the contactor or starter coil.

The module may be directly attached to the coil terminals of any Freedom Series contactor or starter—NEMA Sizes 00–3 and lighting contactors 10–100A. It also has provisions for DIN rail mounting.

The module will operate coils within the voltage ranges shown in the table below.

Design Characteristics

- DC Input: 5–48 Vdc at mA nominal
- AC operating voltage: 240 Vac (360 VA) $\pm 10\%$ 50/60 Hz
- DC operating voltage: 30 Vdc maximum (0.5A)
- AC current rating
 - 10A make (inrush)
 - 1A break (sealed)

Controller Coil Voltage Ranges

| Controller Catalog Number Prefix | Controller Size or Rating | Coil Range Volts AC |
|----------------------------------|---------------------------|---------------------|
| AN16, AN56, CN15, CN55 | 00–0 | 24–240 |
| | 1–2 | 48–240 |
| | 3 | 110–240 |
| CN35 | 10–30A | 24–240 |
| | 60A | 48–240 |
| | 100A | 110–240 |

Typical Application

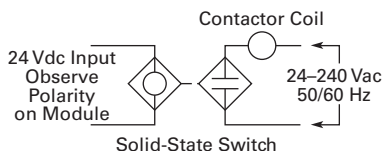

DC/AC Interface Module



Product Selection

| Coil Voltage | Catalog Number |
|--------------|----------------|
| 5 Vdc | C320DC2V5 |
| 6 Vdc | C320DC2V6 |
| 9 Vdc | C320DC2V9 |
| 12 Vdc | C320DC2V12 |
| 48 Vdc | C320DC2V48 |

Finger Protection Shields

Snap-on shields for both contactors and starters provide Type IP20 finger

protection. Prevents accidental contact with line/load terminals.

Product Selection

| Application | Catalog Number |
|----------------------|----------------|
| NEMA Size 00 | C320LS1 |
| NEMA Size 0 | C320LS2 |
| NEMA Sizes 1–2 | |
| Contactors | C320LS3 |
| Reversing contactors | C320LS4 |
| NEMA Size 1 | |
| Starters | C320LS5 |
| Reversing starters | C320LS6 |
| NEMA Size 2 | |
| Starters | C320LS7 |
| Reversing starters | C320LS8 |

Adapter to DIN Rail Mount

NEMA 1–2 Contactors

Designed to allow DIN rail mounting of NEMA 1–2 contactors. Includes all hardware required to convert contactors from panel mounting to 35 mm DIN rail mounting.

Product Selection

| Description | Catalog Number |
|---------------------------|----------------|
| Adapter to DIN rail mount | C320DN65 |

Adhesive Dust Cover

NEMA Sizes 00–2

These adhesive stickers come 25 to a package and provide extra protection from contaminants when applied to the sides of Freedom NEMA Sizes 00–2.

Adhesive covers are easily applied to side opening where auxiliaries are not installed and provide extra protection from metal filings and other debris.

Product Selection

| Description | Catalog Number |
|-----------------|----------------|
| 25 to a package | C320DSTCVR |

Add-On Power Pole Kit

NEMA Sizes 00–2

This device mounts on the side of Freedom NEMA Size 00–2 contactors. One unit can be mounted on each side and carries UL, cUL and IEC ratings. The device is rated for resistive, inductive and lighting applications.

Product Selection—Add-On Power Pole Kit

| UL Ampere Rating | | | | IEC 947 Ampere Rating | | | | | |
|-------------------|-------------------|--------------------|------|-------------------------|--------------------------------------|--------------|--------------|------------------------|-------------------------------------|
| Inductive 600V | Resistive 600V | hp Single-Phase | | Locked Rotor 240V | Lighting Ballast Tungsten 480V | AC-1 600V | AC-3 600V | AC-5a AC-5b 480V | 1NO Power Pole Catalog Number |
| | | 115V | 230V | | | | | | |
| 15 | 20 | 1/2 | 2 | 96 | 20 | 20 | 12 | 18 | C320PPD10 |

Fuse Clips

C351 Fuse Clip Kit



C351—Fuse Clip Selection—Three Poles

| Starter Size | Motor Voltage | Maximum hp (Three-Phase) Dual Element Fuses | Fuse Clip Rating | | Fuse Clip Kit Factory Installed Position 10 Alpha ^① | Fuse Clip Kit for Field Installation in Non-Fusible Starter For Non-Rejection Type Fuses | | For Use with "R" Rejection Type Fuses | |
|---|------------------|--|---------------------|-------|---|--|---------------------------------|--|--|
| | | | Amperes | Volts | | Catalog Number | Catalog Number | | |
| Non-Fusible—without Fuse Clips Installed | | | | | | A | | | |
| 0 | 200/230 | 3 | 30 | 250 | B | C351KC21 | C351KC21R | | |
| | 460/575 | 5 | 30 | 600 | C | C351KD22-61 | C351KD22-61R | | |
| 1 | 200/230 | 7-1/2 | 30 | 250 | B | C351KC21 | C351KC21R | | |
| | 460/575 | 10 | 30 | 600 | C | C351KD22-61 | C351KD22-61R | | |
| 2 | 200 | 10 | 60 | 250 | D | C351KD22-61 | C351KD22-61R | | |
| | 230 | 15 | 60 | 250 | D | C351KD22-61 | C351KD22-61R | | |
| | 460/575 | 25 | 60 | 600 | E | C351KD62 | C351KD62R | | |
| 3 | 200 | 25 | 100 | 250 | F | C351KE23-63 ^② | C351KE23-63 ^② | | |
| | 230 | 30 | 100 | 250 | F | C351KE23-63 ^② | C351KE23-63 ^② | | |
| | 460/575 | 50 | 100 | 600 | G | C351KE23-63 ^② | C351KE23-63 ^② | | |
| 4 | 200 | 40 | 200 | 250 | H | C351KF24-64 ^② | C351KF24-64 ^② | | |
| | 230 | 50 | 200 | 250 | H | C351KF24-64 ^② | C351KF24-64 ^② | | |
| | 460/575 | 100 | 200 | 600 | J | C351KF24-64 ^② | C351KF24-64 ^② | | |
| 5 | 200 | 75 | 400 | 250 | K | Not available in kit form | Not available in kit form | | |
| | 230 | 100 | 400 | 250 | K | | | | |
| | 460/575 | 200 | 400 | 600 | L | | | | |

Notes

- ① These fuse clips are for Class R fuses.
 - ② Fuse clip "R" rejection members for use with Class R fuses are supplied loose in the fuse clip kits.
- Kits do not include fuses.

Control Power Transformer Kits

These control transformer kits provide a convenient on-the-job addition of control transformers to the following Type 1, 3R, 4/4X and 12 enclosed starters. Adding or changing these kits does not affect the UL listing in most instances.

The transformer kit consists of:

- Control transformer
- Two primary and one secondary fuse
- Wires
- Mounting instruction publication

For Non-Combination Starters

These kits may be used for transformer voltage conversion on Freedom NEMA starters furnished from the factory with control transformers installed. Non-combination starters with CPTs factory installed are Class ECN07, ECA07, ECE07 and ECE11. These kits may also be installed in oversize enclosures that have been designed to accept transformers.

Combination Starters

Most combination starters have space for standard size (and 100 VA extra capacity) control power transformers. The panels are pre-drilled for mounting.

UL/CSA

UL Listed—File Number E10156, Guide XPTO.

When Ordering Specify

- Catalog number

Standard Transformer Sizes ^①

| Size | VA Capacity | |
|------|-------------|--------|
| | Freedom | Vacuum |
| 0 | 50 | — |
| 1, 2 | 100 | — |
| 3 | 150 | — |
| 4 | 200 | 100 |
| 5 | 200 | 150 |
| 6 | 250 | 350 |

Control Transformer Kits

Control Transformer Kit



| Continuous VA | Primary 208/277V Secondary 120V, 60 Hz | Primary 240/480V, 60 Hz 220/440V, 50 Hz Secondary 120V, 60 Hz 110V, 50 Hz | Primary 380V Secondary 110V, 50 Hz | Primary 600V, 60 Hz 550V, 50 Hz Secondary 120V, 60 Hz 110V, 50 Hz | Primary 240/480V Secondary 24V, 60 Hz |
|---------------|---|--|---------------------------------------|--|--|
| | Catalog Number | Catalog Number | Catalog Number | Catalog Number | Catalog Number |
| 50 | C341AE | C341AC | C341AL | C341AD | C341AS |
| 75 | C341BE | C341BC | C341BL | C341BD | C341BS |
| 100 | C341CE | C341CC | C341CL | C341CD | C341CS |
| 150 | C341DE | C341DC | C341DL | C341DD | C341DS |
| 200 | C341EE | C341EC | C341EL | C341ED | C341ES |
| 250 | C341FE | C341FC | C341FL | C341FD | C341FS |
| 300 | C341GE | C341GC | C341GL | C341GD | C341GS |
| 350 | C341HE | C341HC | C341HL | C341HD | C341HS |
| 500 | C341JE | C341JC | C341JL | C341JD | C341JS |

Note

^① Non-reversing, single contactor only.

Dimensions

Approximate Dimensions in Inches (mm)

Open Type—50–500 VA with Fuse Block

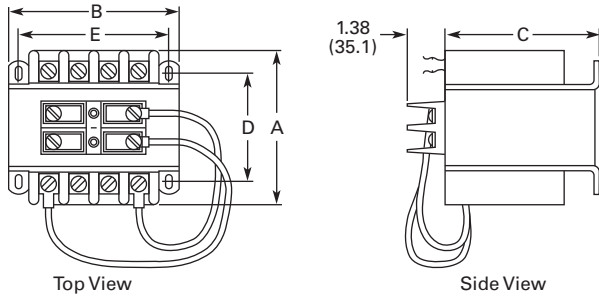

| Continuous VA | Wide A | High B | Deep C | Mounting D | E | Slots | Ship Wt. Lbs (kg) |
|---------------|--------------|--------------|--------------|--------------|--------------|----------------------------|-------------------|
| 50 | 3.00 (76.2) | 3.00 (76.2) | 2.56 (65.0) | 2.00 (50.8) | 2.50 (63.5) | 0.203 x 0.375 (5.2 x 9.5) | 3.0 (1.4) |
| 75 | 3.50 (88.9) | 3.00 (76.2) | 2.56 (65.0) | 2.50 (63.5) | 2.50 (63.5) | 0.203 x 0.375 (5.2 x 9.5) | 4.3 (2.0) |
| 100 | 3.38 (85.9) | 3.38 (85.9) | 2.88 (73.2) | 2.38 (60.5) | 2.81 (71.4) | 0.203 x 0.375 (5.2 x 9.5) | 4.6 (2.1) |
| 150 | 4.00 (101.6) | 3.75 (95.3) | 3.18 (80.8) | 2.88 (73.2) | 3.12 (79.2) | 0.203 x 0.375 (5.2 x 9.5) | 7.0 (3.2) |
| 200 | 4.00 (101.6) | 4.50 (114.3) | 3.81 (96.8) | 2.50 (63.5) | 3.75 (95.3) | 0.203 x 0.375 (5.2 x 9.5) | 7.7 (3.5) |
| 250 | 4.38 (111.3) | 4.50 (114.3) | 3.81 (96.8) | 2.88 (73.2) | 3.75 (95.3) | 0.203 x 0.375 (5.2 x 9.5) | 10.0 (4.5) |
| 300 | 4.75 (120.7) | 4.50 (114.3) | 3.81 (96.8) | 3.25 (82.6) | 3.75 (95.3) | 0.203 x 0.375 (5.2 x 9.5) | 13.0 (5.9) |
| 350 | 5.25 (133.4) | 4.50 (114.3) | 3.81 (96.8) | 3.75 (95.3) | 3.75 (95.3) | 0.203 x 0.375 (5.2 x 9.5) | 14.0 (6.4) |
| 500 | 5.50 (139.7) | 5.25 (133.4) | 4.75 (120.7) | 4.25 (108.0) | 4.38 (111.3) | 0.312 x 0.688 (7.9 x 17.5) | 18.0 (8.2) |

A200 NEMA

Factory Modifications

A200 Factory Modifications

| Modification | Description | NEMA Size | | | | | | | | | Catalog Number Suffix | |
|---------------------------------|---|-----------|---|---|---|---|---|---|---|---|-----------------------|----|
| | | 00-1 | 2 | 3 | 4 | 5 | 6 | 7 | 8 | 9 | | |
| Control circuit | 1 Extra auxiliary contact (1NO-1NC) | | | | | | | | | | | J1 |
| | Non-reversing, reversing | ✓ | ✓ | ✓ | ✓ | ✓ | ✓ | ✓ | ✓ | ✓ | ✓ | |
| | Two-speed unwired | ✓ | ✓ | ✓ | ✓ | ✓ | ✓ | ✓ | ✓ | ✓ | ✓ | |
| | 2 Extra auxiliary contact | | | | | | | | | | | J2 |
| | Non-reversing | ✓ | ✓ | ✓ | ✓ | ✓ | ✓ | ✓ | ✓ | ✓ | ✓ | |
| | Reversing, two-speed unwired | ✓ | ✓ | ✓ | ✓ | ✓ | ✓ | ✓ | ✓ | ✓ | ✓ | |
| | 3 Extra auxiliary contact | | | | | | | | | | | J3 |
| Non-reversing, unwired | ✓ | ✓ | ✓ | ✓ | — | — | — | — | — | — | | |
| 4 Extra auxiliary contact | | | | | | | | | | | J4 | |
| Non-reversing, unwired | ✓ | ✓ | ✓ | ✓ | — | — | — | — | — | — | | |
| | Wired for separate control (NC) | — | — | — | — | — | — | — | — | — | C | |
| | Omit control wiring (NC) | ✓ | ✓ | ✓ | ✓ | ✓ | ✓ | ✓ | ✓ | ✓ | X | |
| Overload relays (substitutions) | Ambient compensated with auto reset (NC) | — | — | — | — | — | — | — | — | — | D | |
| | Fast trip—ambient compensated (specify motor FLA) | ✓ | ✓ | ✓ | ✓ | ✓ | ✓ | — | — | — | D7 | |
| | Overload relay alarm contact (NO) per overload | ✓ | ✓ | ✓ | ✓ | ✓ | ✓ | — | — | — | E | |

Type J Auxiliary Contact

- Capable of being field mounted in a contactor or starter (Classes A200, A900 Sizes 00-6, V200, V201 vacuum and definite purpose controllers)
- Provides two separate electrical contact sets which wire vertically and are color coded; black designates NC and silver designates NO. Please note that the vertical wiring is contrary to the horizontal wiring of the L-56 auxiliary contacts
- Designed to fit within dimensions of starter; no additional panel space is required
- Provides circuit isolation (no polarity restrictions) and single break bifurcated contacts

Auxiliary Contact Ratings

| Voltage | Make | Break |
|------------------|---------|--------|
| NEMA A600 | | |
| 120-600 Vac | 7200 VA | 720 VA |
| 72-120 Vac | 60A | 720 VA |
| 28-72 Vac | 60 VA | 10A |
| NEMA R300 | | |
| 28-300 Vdc | 28 VA | 28 VA |

Auxiliary Contact



Auxiliary Contact Types

| Contact Type | Maximum | Catalog Number |
|----------------------------|---------|----------------|
| 1NO and 1NC | 4 | J11 |
| 2NC | 4 | J02 |
| 2NO | 4 | J20 |
| 1 coil clearing NC and 1NO | 4 | J1C |

Heater Selection

General Information on Heater Coil Selection

For maximum motor protection and compliance with Article 430-32 of the National Electrical Code, select heater coils from the tables in this section on the basis of motor nameplate full load current.

When the full load current is unknown, selection may be made on the basis of average full load currents. **Caution—The average ratings could be high or low for a specific motor and therefore**

selection on this basis always involves risk. For fully reliable motor protection, select heater coils on the basis of full load current rating as shown on the motor nameplate.

Heater coils are rated to protect 40°C rise motors, and open and drip-proof motors having a **service factor of 1.15** where the motor and the controller are at the same ambient temperature.

For other conditions:

1. For 50°C, 55°C, 75°C rise motors and **enclosed motors having a service factor of 1.0, select one size smaller coil.**
2. Ambient temperature of controller lower than motor by 26°C (47°F), use one size smaller coil.
3. Ambient temperature of controller higher than motor by 26°C (47°F), use one size larger coil.

Ultimate tripping current of heater coils is approximately 1.25 times the minimum current rating listed in the tables.

Heater Selection— Type A and B Overload Relays, Sizes 3 and 4

| Size Starter | Ambient Compensated Enclosed Starters | Non-Compensating Enclosed Starters | Heater (One Heater per Catalog Number) |
|---------------------|---------------------------------------|------------------------------------|--|
| | All Applications | Full Load Current of Motor Amps | Catalog Number |
| For Size 4 Starters | 12.8–14.1 | 11.9–13.0 | FH68 |
| | 14.2–15.5 | 13.1–14.3 | FH69 |
| | 15.6–17.1 | 14.4–15.9 | FH70 |
| | 17.2–18.9 | 16.0–17.4 | FH71 |
| | 19.0–20.8 | 17.5–19.1 | FH72 |
| | 20.9–22.9 | 19.2–21.1 | FH73 |
| | 23.0–25.2 | 21.2–23.2 | FH74 |
| | 25.3–27.8 | 23.3–25.6 | FH75 |
| | 27.9–30.6 | 25.7–28.1 | FH76 |
| | 30.7–33.5 | 28.2–30.8 | FH77 |
| For Size 3 Starters | 33.6–37.5 | 30.9–34.5 | FH78 |
| | 37.6–41.5 | 34.6–38.2 | FH79 |
| | 41.6–56.3 | 38.3–42.6 | FH80 |
| | 46.4–50 | 42.7–46 | FH81 |

| Size Starter | Ambient Compensated Enclosed Starters | Non-Compensating Enclosed Starters | Heater (One Heater per Catalog Number) |
|---------------------|---------------------------------------|------------------------------------|--|
| | All Applications | Full Load Current of Motor Amps | Catalog Number |
| For Size 4 Starters | 51–55 | 47–51 | FH82 |
| | 56–61 | 52–56 | FH83 |
| | 62–66 | 57–61 | FH84 |
| | 67–73 | 62–67 | FH85 |
| | 74–78 | 68–72 | FH86 |
| | 79–84 | 73–77 | FH87 |
| | 85–92 | 78–84 | FH88 |
| | 93–101 | 85–91 | FH89 |
| | 102–110 | 92–99 | FH90 |
| | 111–122 | 100–110 | FH91 |
| For Size 3 Starters | 123–129 | 111–122 | FH92 |
| | 130–133 | 123–128 | FH93 |
| | — | 129–133 | FH94 |

Heater Selection— Type A and B Overload Relays, Sizes 5 and 6

| Compensated Overload Relay | | Heater (One Heater per Catalog Number) |
|---|------------------|--|
| Open Starter | Enclosed Starter | |
| Full Load Current of Motor (Amps) | | Catalog Number |
| Size 5 (with 300/5 Current Transformers) | | |
| — | — | FH23 |
| 118–129 | 118–129 | FH24 |
| 130–141 | 130–141 | FH25 |
| 142–155 | 142–155 | FH26 |
| 156–170 | 156–170 | FH27 |
| 171–187 | 171–187 | FH28 |
| 188–205 | 188–205 | FH29 |
| 206–224 | 206–224 | FH30 |
| 225–244 | 225–244 | FH31 |
| 245–263 | 245–263 | FH32 |
| 264–292 | 264–292 | FH33 |
| 293–300 | — | FH34 |

| Compensated Overload Relay | | Heater (One Heater per Catalog Number) |
|---|------------------|--|
| Open Starter | Enclosed Starter | |
| Full Load Current of Motor (Amps) | | Catalog Number |
| Size 6 (with 600/5 Current Transformers) | | |
| — | — | FH23 |
| 236–259 | 236–259 | FH24 |
| 260–283 | 260–283 | FH25 |
| 284–310 | 284–310 | FH26 |
| 311–340 | 311–340 | FH27 |
| 341–374 | 341–374 | FH28 |
| 375–411 | 375–411 | FH29 |
| 412–448 | 412–448 | FH30 |
| 449–489 | 449–489 | FH31 |
| 490–527 | 490–527 | FH32 |
| 528–585 | 528–540 | FH33 |
| 586–600 | — | FH34 |

Note

Size 7 and larger—advise full load current.

15.1

Accessories and Modification Codes

Accessories

Heater Selection—Type A and B Overload Relays, Sizes 0, 1 and 2

| Size Starter | Non-Compensated Open Starters and Ambient Comp. Open and Enclosed Starters Block Type Overload Using Three Heaters Full Load Current of Motor (Amps) | Single-Pole Type Overload | Heater (One Heater per Catalog Number) Catalog Number | Non-Compensating Enclosed Starters Block Type Overload Using Three Heaters Full Load Current of Motor (Amps) | Single-Pole Type Overload | Heater Catalog Number |
|--------------|--|---------------------------|--|--|---------------------------|-----------------------|
| | 0.25–0.27 | 0.29–0.31 | FH03 | 0.24–0.25 | 0.28–0.30 | FH03 |
| | 0.28–0.31 | 0.32–0.35 | FH04 | 0.26–0.28 | 0.31–0.34 | FH04 |
| | 0.32–0.34 | 0.36–0.39 | FH05 | 0.29–0.31 | 0.35–0.37 | FH05 |
| | 0.35–0.38 | 0.44–0.48 | FH06 | 0.32–0.35 | 0.38–0.42 | FH06 |
| | 0.39–0.42 | 0.44–0.48 | FH07 | 0.36–0.39 | 0.43–0.47 | FH07 |
| | 0.43–0.46 | 0.49–0.53 | FH08 | 0.40–0.43 | 0.48–0.52 | FH08 |
| | 0.47–0.50 | 0.54–0.58 | FH09 | 0.44–0.47 | 0.53–0.56 | FH09 |
| | 0.51–0.55 | 0.59–0.64 | FH10 | 0.48–0.51 | 0.57–0.63 | FH10 |
| | 0.56–0.62 | 0.65–0.71 | FH11 | 0.52–0.57 | 0.64–0.70 | FH11 |
| | 0.63–0.68 | 0.72–0.79 | FH12 | 0.58–0.63 | 0.71–0.77 | FH12 |
| | 0.69–0.75 | 0.80–0.87 | FH13 | 0.64–0.70 | 0.78–0.85 | FH13 |
| | 0.76–0.83 | 0.88–0.96 | FH14 | 0.71–0.77 | 0.86–0.94 | FH14 |
| | 0.84–0.91 | 0.97–1.06 | FH15 | 0.78–0.85 | 0.95–1.03 | FH15 |
| | 0.92–1.00 | 1.07–1.16 | FH16 | 0.86–0.93 | 1.04–1.13 | FH16 |
| | 1.01–1.11 | 1.17–1.28 | FH17 | 0.94–1.03 | 1.14–1.25 | FH17 |
| | 1.12–1.22 | 1.29–1.41 | FH18 | 1.04–1.13 | 1.26–1.38 | FH18 |
| | 1.23–1.34 | 1.42–1.55 | FH19 | 1.14–1.25 | 1.39–1.52 | FH19 |
| | 1.35–1.47 | 1.56–1.71 | FH20 | 1.26–1.37 | 1.53–1.67 | FH20 |
| | 1.48–1.62 | 1.72–1.87 | FH21 | 1.38–1.51 | 1.68–1.83 | FH21 |
| | 1.63–1.78 | 1.88–2.06 | FH22 | 1.52–1.65 | 1.84–2.01 | FH22 |
| | 1.79–1.95 | 2.07–2.26 | FH23 | 1.66–1.81 | 2.02–2.21 | FH23 |
| | 1.96–2.15 | 2.27–2.48 | FH24 | 1.82–1.99 | 2.22–2.43 | FH24 |
| | 2.16–2.35 | 2.49–2.72 | FH25 | 2.00–2.19 | 2.44–2.66 | FH25 |
| | 2.36–2.58 | 2.73–2.99 | FH26 | 2.20–2.39 | 2.67–2.92 | FH26 |
| | 2.59–2.83 | 3.00–3.28 | FH27 | 2.40–2.63 | 2.93–3.21 | FH27 |
| | 2.84–3.11 | 3.29–3.60 | FH28 | 2.64–2.89 | 3.22–3.53 | FH28 |
| | 3.12–3.42 | 3.61–3.95 | FH29 | 2.90–3.17 | 3.54–3.87 | FH29 |
| | 3.43–3.73 | 3.96–4.31 | FH30 | 3.18–3.47 | 3.88–4.22 | FH30 |
| | 3.74–4.07 | 4.32–4.71 | FH31 | 3.48–3.79 | 4.23–4.61 | FH31 |
| | 4.08–4.39 | 4.72–5.14 | FH32 | 3.80–4.11 | 4.62–4.9 | FH32 |
| | 4.40–4.87 | 5.15–5.6 | FH33 | 4.12–4.55 | 5.0–5.5 | FH33 |
| | 4.88–5.3 | 5.7–6.2 | FH34 | 4.56–5.0 | 5.6–6.0 | FH34 |
| | 5.4–5.9 | 6.3–6.8 | FH35 | 5.1–5.5 | 6.1–6.6 | FH35 |
| | 6.0–6.4 | 6.9–7.5 | FH36 | 5.6–5.9 | 6.7–7.3 | FH36 |
| | 6.5–7.1 | 7.6–8.2 | FH37 | 6.0–6.6 | 7.4–8.0 | FH37 |
| | 7.2–7.8 | 8.3–9.0 | FH38 | 6.7–7.2 | 8.1–8.7 | FH38 |
| | 7.9–8.5 | 9.1–9.9 | FH39 | 7.3–7.9 | 8.8–9.7 | FH39 |
| | 8.6–9.4 | 10.0–10.8 | FH40 | 8.0–8.7 | 9.8–10.5 | FH40 |
| | 9.5–10.3 | 10.9–11.9 | FH41 | 8.8–9.5 | 10.6–11.7 | FH41 |
| | 10.4–11.3 | 12.0–13.1 | FH42 | 9.6–10.5 | 11.8–12.7 | FH42 |
| | 11.4–12.4 | 13.2–14.3 | FH43 | 10.6–11.5 | 12.8–14.0 | FH43 |
| | 12.5–13.5 | 14.4–15.7 | FH44 | 11.6–12.6 | 14.1–15.3 | FH44 |
| | 13.6–14.9 | 15.8–17.2 | FH45 | 12.7–13.8 | 15.4–16.6 | FH45 |
| | 15.0–16.3 | 17.3–18.9 | FH46 | 13.9–15.1 | 16.7–18.3 | FH46 |
| | 16.4–18.0 | 19.0–20.8 | FH47 | 15.2–16.7 | 18.4–20.0 | FH47 |
| | 18.1–19.8 | 20.9–22.9 | FH48 | 16.8–18.3 | 20.1–21.9 | FH48 |
| | 19.9–21.7 | 23.0–25.2 | FH49 | 18.4–20.2 | 22.0–23.9 | FH49 |
| | 21.8–23.9 | 25.3–27.6 | FH50 | 20.3–22.2 | 24.0–26.2 | FH50 |
| | 24.0–26.2 | 27.7–30.3 | FH51 | 22.3–24.3 | 26.3–28.8 | FH51 |
| | 26.3–28.7 | 30.4–33.3 | FH52 | 24.4–26.6 | 28.9–31.4 | FH52 |
| | 28.8–31.4 | 33.4–36.4 | FH53 | 26.7–29.1 | 31.5–34.5 | FH53 |
| | 31.5–34.5 | 36.5–39.9 | FH54 | 29.2–32.0 | 34.6–37.9 | FH54 |
| | 34.6–37.9 | 40.0–43.9 | FH55 | 32.1–35.2 | 38.0–41.9 | FH55 |
| | 38.0–41.5 | | FH56 | 35.3–38.5 | 42.0–45.0 | FH56 |
| | 41.6–45.0 | | FH57 | 38.6–42.3 | | FH57 |

SS-56 Surge Suppressor

- Designed to be used with magnetic motor controllers through Size 4 in 120V, 60 Hz control circuit applications where electronic equipment is used
- Steady state coil volts: 120, 60 Hz, rms
- Peak input volts: 169.6, 60 Hz, maximum amplitude
- Maximum ambient temperature: 65°C
- Nominal limiting volts: 270 peak
- Nominal rate of volt rise: 0.5 per ms

SS-56 Surge Suppressor



Surge Suppressor ①

| Type Mounting | Kit Catalog Number |
|---------------|--------------------|
| Starter | SS-56 |

F-56 Fuse Block

- Facilitates installation of fuses (15A, 600V max.) in control circuits
- Utilizes Bussman type KTK fuses, or equivalent
- Mounts in same cavity as Type J auxiliary contact
- No tools or mounting hardware needed
- Fuse not included

Fuse Block

| Mounting | Kit Catalog Number |
|----------|--------------------|
| Starter | F56 |
| Panel | F56-P |

R-56 Interposing Relay

The R-56AA interposing relay is a low energy solid-state device with a single NO solid-state contact. It can be used as a 120 Vac control relay, and will operate on as little as 40 Vac input. Is useful in

applications requiring long control wiring runs where excessive voltage drop would prevent the contactor or relay from energizing. Will operate a Size 4 contactor from 10,000 ft using 18 AWG wire.

Interposing Relay

| Type Mounting | Kit Catalog Number |
|------------------|--------------------|
| Starter or panel | R56-AA |

Mechanical Interlock

- Prevents closing of one member of a reversing or multi-speed contactor until the opposite member is completely open
- Lever type mechanism assures positive action
- Can be factory assembled or field mounted on A200 and A900 starters and contactors

Mechanical Interlock

| Contact Arrangement (Number of Poles, Horizontal or Vertical) | Continuous Size | Interlock Catalog Number |
|---|-----------------|--------------------------|
| 3 x 3 horizontal | 0, 1 | M-33-1B |
| 4 x 4 horizontal | 0, 1 | M-33-1B |
| 5 x 3 horizontal | 0, 1 | M-33-1B |
| All pole combination, vertical | 0, 1 | M-34-1A |
| 3 x 3 horizontal reversing | 2 | M-33-2B |
| 3 x 3 vertical reversing | 2 | M-34-2A |
| 5 x 3 horizontal | 2 | M-35-2A |
| 4 x 4 horizontal | 2 | M-36-2A |
| All pole combination horizontal | 3, 4 | M-33-3B |
| All pole combination vertical | 3, 4 | M-34-3 |

B3NO Bell Alarm Contact

- Isolated normally open bell alarm contact
- Mounts in Type B block-type overload relay

Bell Alarm Contact

| Kit Catalog Number |
|--------------------|
| B3NO-2 |
| B3NO-4 ② |

Control Contact Ratings (B600)

| AC Volts | Maximum Amperes | |
|----------|-----------------|--------|
| | Make | Break |
| 24–120 | 30 | 3.00 |
| 121–600 | 3600 VA | 360 VA |

Continuous current rating: 5A

Overload Relay Reset Extension

- Used to adjust overload reset rod depth of Class A200 Model J starters and current design overload relays to same dimensions as obsolete B200 starters and overloads identified by suffix **B**, that is BA13B

When replacing obsolete B200 device with Class A200 starter and Type B overload, order Style 6710C11H03. No charge.

When replacing obsolete B200 device with Class A200 starter and Type A overload, order Style 1490C15H10. No charge.

Notes

- ① Can be used on Sizes 5 and 6 with 120V coil. Mounting bracket required—order separately. Mounting bracket 177C043G04.
- ② For Size 3 and 4.

15.1

Accessories and Modification Codes

Accessories

Power Pole Kit

- Adds 1NO or 1NC power pole to Size 00–1 A201 Class contactors
- Factory installed or field mountable in load side auxiliary cavities
- 600 Vac
- Continuous current rating of 18A for Size 0, 27A for Size 1

Power Pole Kit ①

| Continuous Current Rating | Kit Size | Kit Catalog Number |
|---------------------------|----------|--------------------|
| Normally Open | | |
| 18 | 0 | PN0-0 |
| 27 | 1 | PN0-1 |
| Normally Closed | | |
| 18 | 0 | PNC-0 |
| 27 | 1 | PNC-1 |

Replacement Auxiliary Contacts

Replacement Auxiliary Contacts

| Contactor Size | Contact Arrangement | Aux. Elect. Contact | |
|----------------|---------------------|---------------------|-------------------|
| | | Catalog Number | Style Number |
| 5, 6 | 1NO + 1NC | J11 | 9084A17G01 |
| | 2NO | J20 | 9084A17G02 |
| | 2NC | J02 | 9084A17G03 |
| 7, 8 | 1NO | — | 578D461G01 |
| | 1NC | — | 578D461G03 |
| 9 | 1NO + 1NC | — | 843D943G04 |
| | 2NO | — | 843D943G05 |
| | 2NC | — | 843D943G06 |

Extra Auxiliary Contact Kits

All starters include an auxiliary contact with 1NO and 1NC contact. These kits include an auxiliary contact

with contacts as shown, plus operating arm and mounting bracket when required.

Extra Auxiliary Contact Kits

| Contactor Size | Contact Arrangement | Style Number |
|----------------|---------------------|-------------------|
| 5, 6 | 1NO + 1NC | 3463D94G18 |
| | 2NO | 3463D94G04 |
| | 2NC | 3463D94G19 |
| 7, 8 ② | 2NO | 818D498G06 |
| | 1NO | 818D498G04 |

DC Coil Conversion Kits

Kits listed below include all necessary parts to convert from AC to DC control including the DC coil with

built-in diode, rectifier, auxiliary interlock and all mounting hardware.

DC Coil Conversion Kits

| Size | Voltage | Kit Style Number |
|------|---------|-------------------|
| 5 | 110-120 | 7864A28G01 |
| | 220-240 | 7864A28G02 |
| | 440-480 | 7864A28G03 |
| 6 | 110-120 | 7864A29G01 |
| | 220-240 | 7864A29G02 |
| | 440-480 | 7864A29G03 |

Mechanical Interlocks

Mechanical Interlocks

| Contactor Sizes | Style Numbers | |
|-----------------|-------------------|-------------------|
| | Horizontal | Vertical |
| 3, 4 and 5 | 2050A11G75 | 2050A11G65 |
| 5 and 5 | 2050A11G25 | 2050A11G15 |
| 5 and 6 | 2050A11G27 | 2050A11G17 |
| 6 and 6 | 2050A11G26 | 2050A11G16 |
| 6 and 7, 8 | — | 2050A11G55 |
| 7, 8 and 7, 8 | No (rear conn.) | 567D624G01 |
| 7, 8 and 9 | No (rear conn.) | 9944D56G06 |
| 9 and 9 | No (rear conn.) | 9944D56G01 |

Overload Protection

Overload Protection Size 5 Starters

Type B overload relay is a three-pole, block type, thermal ambient compensated device with manual reset mounted integrally. Current transformers

are enclosed in a protective case and integrally mounted to save panel space. Standard ratio is 300:5.

Overload Protection Size 6 Starters

Overload protection assembly consists of three current transformers, Type B three-pole block overload relay and an optional interposing relay. These parts are mounted on a panel which connects directly to the load terminal of the

contactor. Current transformers are 600:5 ratio as standard.

If automatic reset is required, the Type A, three-pole block, ambient compensated relay is available upon request.

Notes

- ① Do not use with DC operated contactors.
- ② Size 7 and larger use DC coils as standard.

Overload Relay Kits

Each kit includes three current transformers (standard ratio) and one Type B, three-pole block overload relay, ambient compensated with manual reset.

Overload Relay Kits

| Kit Size | Kit Part Number |
|----------|-----------------|
| 5 | 2057A34G01 |
| 6 | 6379D80G10 |

Replacement Terminal Lugs ①

| Contactor Size | Cable Size | Terminals | | Kit Style Number |
|----------------|-------------|-------------|----------------------|------------------|
| | | Qty. in Kit | Qty. Req'd. per Pole | |
| 5 | 1-500 kcmil | 6 | 2 | 2119A76G01 |
| 6 | 2-500 kcmil | 6 | 2 | 7858A96G01 |
| 7 | 4-500 kcmil | 12 | 4 | 7858A96G02 |
| 8 | 4-500 kcmil | 12 | 4 | 7858A96G03 |

XTIEC

Auxiliary Contacts

Front mounted snap-on auxiliary contacts for **XT** contactors are available with screw or spring cage terminals in a variety of contact configurations.

The 7–32A XTCE contactors have positively driven contacts between the integrated auxiliary contact and the auxiliary contact module as well as within the auxiliary contact modules.

The 40–65A XTCE contactors have positively driven contacts within the auxiliary contact module. Six auxiliary contacts are possible with a combination of side-mounted and front-mount auxiliary contacts.

Frame B–C contactors with 1NC built-in auxiliary are mirror contacts (XTCE...B01_–XTCE...C01_).

XTCE and XTCS Auxiliary Contact Overview

| Frame | A | B | C | D | F | G | L–R |
|------------------------------|---|---|-----------------------------------|--|-----------------------------|-----------------------------|-------------------------------|
| Catalog numbers | XTMC6A_– XTMC9A_ | XTCE007B_– XTCE015B_ | XTCE018C_– XTCE032C_ | XTCE040D00_– XTCE065D00_ | XTCE080F00_– XTCE095F00_ | XTCE115G00_– XTCE150G00_ | XTCE185L22_– XTCEC20R22_ ② |
| Contactor width | 45 mm | 45 mm | 45 mm | 55 mm | 90 mm | 90 mm | Various |
| Built-in auxiliary | 1NO or 1NC | 1NO or 1NC | 1NO or 1NC | — | — | — | 2NO-2NC |
| Contact sequence | | | | | | | |
| Front- (top) mount auxiliary | Two- and four-pole (screw or spring cage): | Standard two- and four-pole versions (screw or spring cage): | | Two-pole (screw only): | | | N/A |
| | | Tall version (screw only): | | Four-pole (screw or spring cage): | | | |
| Side-mount auxiliary | N/A | N/A | Two-pole (screw only): | Two-pole (screw or spring cage): | | | |

Notes











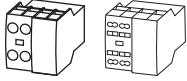



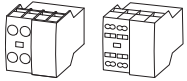

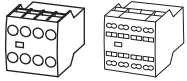

- ① All mounting hardware is included in kit.
- ② Frame L–R auxiliary contacts also apply to XTCS185_–XTCS500M_ contactors.

15.1

Accessories and Modification Codes

Accessories













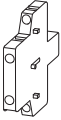

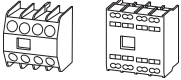

Auxiliary Contacts

| | | Conventional Thermal Current, Open at 60°C $I_{th} = I_e$ AC-1 in Amps | Poles | Contact Configuration | Circuit Symbol | Pkg. Qty. | Screw Terminals Catalog Number | Spring Cage Terminals Catalog Number |
|---|----|--|-------|------------------------------------|---|--------------|-----------------------------------|---|
| Frame B-C—Front- (Top) Mount | | | | | | | | |
|  | 16 | | 2 | 2NO |  | 5 | XTCEXFAC20 | XTCEXFACC20 |
| | 16 | | 2 | 1NO-1NC |  | 5 | XTCEXFAC11 | XTCEXFACC11 |
| | 16 | | 2 | 2NC |  | 5 | XTCEXFAC02 | XTCEXFACC02 |
| | 16 | | 2 | 1NO _E -1NC _L |  | 5 | XTCEXFALC11 ① | XTCEXFALCC11 ① |
|  | 16 | | 2 | 1NO-1NC |  | 5 | XTCEXFDC11 ② | XTCEXFDC11 ② |
| | 16 | | 2 | 2NC |  | 5 | XTCEXFCC02 ② | XTCEXFCC02 ② |
|  | 16 | | 4 | 4NO |  | 5 | XTCEXFAC40 | XTCEXFACC40 |
| | 16 | | 4 | 3NO-1NC |  | 5 | XTCEXFAC31 | XTCEXFACC31 |
| | 16 | | 4 | 2NO-2NC |  | 5 | XTCEXFAC22 | XTCEXFACC22 |
| | 16 | | 4 | 1NO-3NC |  | 5 | XTCEXFAC13 | XTCEXFACC13 |
| | 16 | | 4 | 4NC |  | 5 | XTCEXFAC04 | XTCEXFACC04 |
| | 16 | | 4 | 1NO _E -1NC _L |  | 5 | XTCEXFCLC22 ① | XTCEXFCLCC22 ① |
| | 16 | | 4 | 2NO-2NC |  | 5 | XTCEXFCC22 ② | XTCEXFCC22 ② |
| Frame B-C—Front- (Top) Mount—Tall Version ③ | | | | | | | | |
|  | 16 | | 2 | 2NO |  | 5 | XTCEXFATC20 | — |
| | 16 | | 2 | 1NO-1NC |  | 5 | XTCEXFATC11 | — |
| | 16 | | 2 | 2NC |  | 5 | XTCEXFATC02 | — |

Notes

- ① One early-make contact (1NO_E), one late-break contact (1NC_L).
- ② To avoid duplicate terminal numbers in contact sequence, these auxiliary contacts should only be used with contactors having a built-in 1NO contact (XTCE...B10_, XTCE...C10_).
- ③ Front- (top) mount tall version is for use with Frame B electrical wire bridges and link kits and toolless plug combination connection kits: XTCEXRLL, XTCEXSDLB, XTPAXTPCB, XTPAXTPCRB, XTPAX.

Auxiliary Contacts, continued

| | Conventional Thermal Current, Open at 60°C I _{th} = I _e , AC-1 in Amps | Poles | Contact Configuration | Circuit Symbol | Pkg. Qty. | Screw Terminals Catalog Number | Spring Cage Terminals Catalog Number |
|---|--|-------|------------------------------------|---|-----------|--------------------------------|--------------------------------------|
| Frame B-C—Front- (Top) Mount—Tall Version, continued ① | | | | | | | |
|  | 16 | 4 | 2NO-2NC |  | 5 | XTCEXFATC22 | — |
| Frame C—Side-Mount | | | | | | | |
|  | 10 | 2 | 1NO-1NC |  | 1 | XTCEXSCC11 ② | — |
| Frame D-G | | | | | | | |
|  | 16 | 2 | 2NO |  | 5 | XTCEXFBG20 | — |
| | 16 | 2 | 1NO-1NC |  | 5 | XTCEXFAG11 | — |
| | 16 | 2 | 1NO-1NC |  | 5 | XTCEXFBG11 | — |
| | 16 | 2 | 2NC |  | 5 | XTCEXFBG02 | — |
|  | 16 | 4 | 4NO-0NC |  | 5 | XTCEXFBG40 | XTCEXFBGC40 |
| | 16 | 4 | 3NO-1NC |  | 5 | XTCEXFBG31 | XTCEXFBGC31 |
| | 16 | 4 | 2NO-2NC |  | 5 | XTCEXFBG22 | XTCEXFBGC22 |
| | 16 | 4 | 2NO-2NC |  | 5 | XTCEXFAG22 | XTCEXFAGC22 |
| | 16 | 4 | 1NO-3NC |  | 5 | XTCEXFBG13 | XTCEXFBGC13 |
| | 16 | 4 | 0NO-4NC |  | 5 | XTCEXFBG04 | XTCEXFBGC04 |
| | 16 | 4 | 1NO _E -1NC _L |  | 5 | XTCEXFBG22 ③ | XTCEXFBGC22 ③ |

Notes

① Front- (top) mount tall version is for use with Frame B electrical wire bridges and link kits and toolless plug combination connection kits: XTCEXRLB, XTCEXSDLB, XTPAXTPCB, XTPAXTPCRB, XTPAX.

② Can be mounted to the left side of contactor only. Cannot be used in combination with front- (top) mount auxiliary contacts or mechanical interlocks.

③ One early-make contact (1NO_E), one late-break contact (1NC_L).

Interlocked opposing contacts, to IEC/EN 60947-5-1 Annex L (positively driven), within the auxiliary contact modules (not NO [early make] and NC [late break] contacts) and for the built-in auxiliary contacts of the XTCE007B_–XTCE032C_.

Auxiliary break contact can be used as mirror contact to IEC/EN 60947-4-1 Annex F (not NC [late break] contact).





No auxiliary contacts can be fitted between two contactors.

15.1



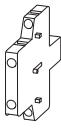













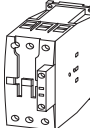

Accessories and Modification Codes

Accessories

Side-Mount Auxiliary Contacts for Frame D–R, 40–2000A

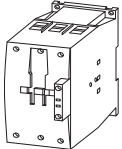
| | Conventional Free Air Thermal Current, $I_{th} = I_e$, AC-1 in Amps | Poles | Contact Configuration | Circuit Symbol | Pkg. Qty. | Screw Terminal Catalog Number | Spring Cage Terminal Catalog Number |
|---|--|-------|------------------------------------|---|-----------|-------------------------------|-------------------------------------|
|  | 10 | 2 | 1NO-1NC |  | 1 | XTCEXSBN11 | XTCEXSBN11 |
| | 10 | 2 | 1NO _E -1NC _L |  | 1 | XTCEXSBLN11 ① | — |
| | 10 | 2 | 1NO-1NC |  | 1 | XTCEXSCN11 ② | XTCEXSCN11 ② |

Auxiliary Contacts Possible Combinations

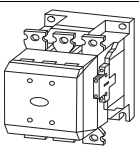
| Frame Size | Contactor | Built-In Auxiliary | Front- (Top) Mount | | Side-Mount Two-Pole | Total Auxiliary Contacts Available | Catalog Number |
|------------|---|--------------------|---|---|---|------------------------------------|----------------|
| | | | Two-Pole | Four-Pole | | | |
| A |  | 1NO or 1NC | 1 | — | — | 3 | XTMC6A_ |
| | | | — | 1 | — | 5 | XTMC9A_ |
| | | |  |  | — | — | — |
| B |  | 1NO or 1NC | 1 | — | — | 3 | XTCE007B_ |
| | | | — | 1 | — | 5 | XTCE015B_ |
| | | |  |  | — | — | — |
| C |  | 1NO or 1NC | 1 | — | — | 3 | XTCE018C_ |
| | | | — | 1 | — | 5 | XTCE032C_ |
| | | | — | — | 1 | 3 | — |
| | | |  |  |  | — | — |
| D |  | — | 1 | — | 2 | 6 | XTCE040D00_ |
| | | | — | 1 | 1 | 6 | XTCE065D00_ |
| | | |  |  |  | — | — |
| F–G |  | — | 1 | — | 2 | 6 | XTCE080F00_ |
| | | | — | 1 | 2 | 8 | XTCE150G00_ |
| | | | — | — | 4 | 8 | — |
| | | |  |  |  | — | — |
| L–R |  | 2NO-2NC | — | — | 2 | 8 | XTCE185L22_ |
| | | | — | — | — | — | XTCEC20R22_ |

Notes

- ① One early-make contact (1NO_E), one late-break contact (1NC_L).
 - ② To maintain proper terminal marking, XTCEXSCN_ should not be used with Frame D contactors and only used with Frame F–G contactors in combination with XTCEXSBN_.
- Forced operation contact to IEC/EN 60947-5-1 Appendix L (positively driven), inside the auxiliary contact unit (not early close and late opening).
 Auxiliary normally closed contact can be used as mirror contact to IEC/EN 60947-4-1 Appendix F (not late opening).
 No auxiliary contacts can be fitted between two contactors.

Auxiliary Contact Combinations

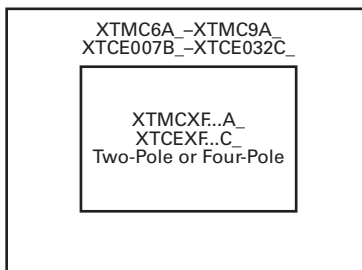

Frame A–B

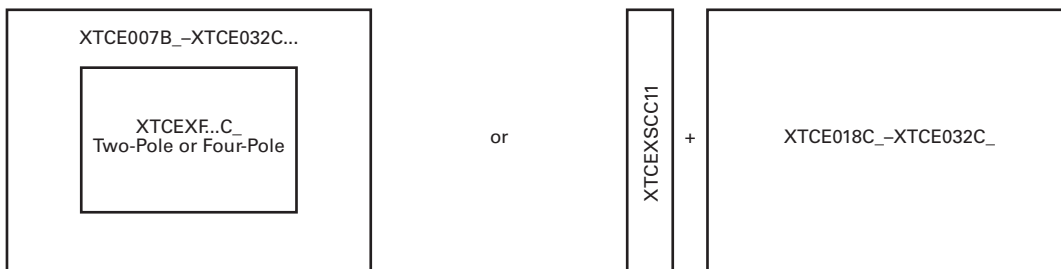

Frame C

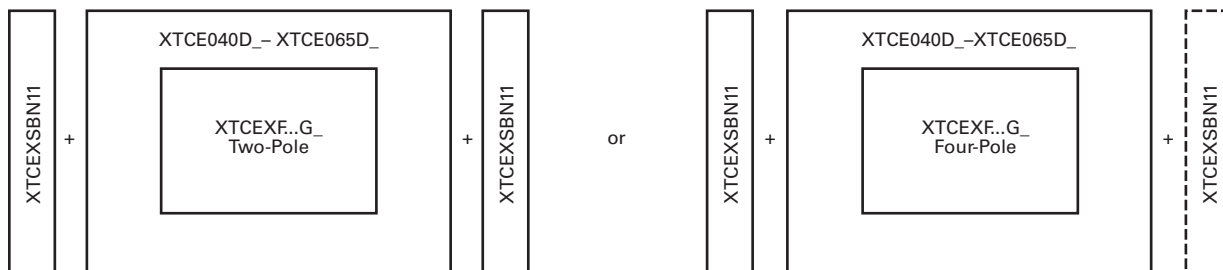

Frame D

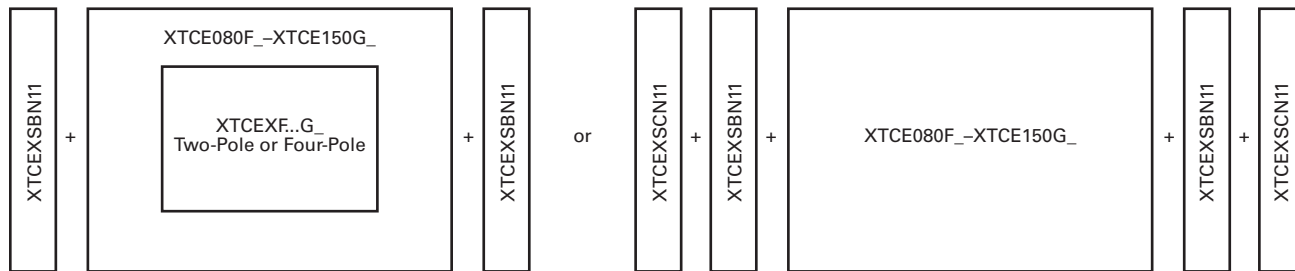

Frame F–G

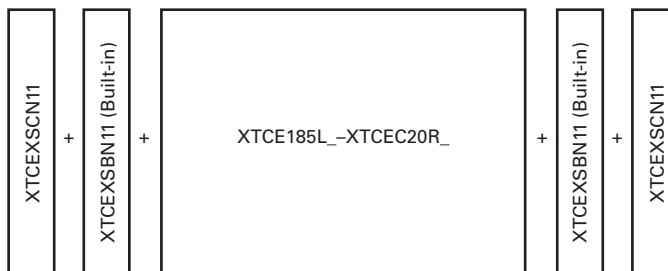

Frame L–R

Enclosures

Type 1 Enclosures

Type 1 Enclosure



Type 1 Enclosures—NEMA (Freedom)

| Starter Type | Box Number | NEMA Size AN16 | Catalog Number |
|--|------------|----------------|-----------------------|
| Non-reversing starter | 1 | 00–1 | C799B11 ^{①②} |
| | 1 | — | C799B12 ^① |
| | 2 | 2 | C799B13 |
| | 4 | 3–4 | C799B15 |
| | 10 | 5 | C799B17 |
| Non-reversing starter with space for CPT | 3 | 00–2 | C799B14 ^③ |
| | 4 | 3–4 | C799B15 ^④ |
| Reversing starter | 2 | 00–0 | C799B13 |
| | 3 | 1–2 | C799B14 |
| | 4 | 3 | C799B15 |
| | 9 | 4 | C799B16 |
| | 10 | 5 | C799B17 |

Dummy Contact Block

| Application | Catalog Number |
|---------------------|----------------|
| Dummy contact block | C320KGSD |

Notes

- ① In order to install cover control kits for NEMA Sizes 00–2 and IEC Sizes A–F, the starter must be provided with a **side-mounted** auxiliary contact or a separately ordered dummy contact block, **C320KGSD** from table above, to serve as a mounting base. **Note:** NEMA Size 00 open type devices **are not** supplied as standard with side-mounted auxiliaries.
- ② If 8 AWG wire is used with NEMA Size 1 starter, the enclosure should be changed to a Box 2 (C799B13).
- ③ Sub panel drilled for 50–200 VA CPTs.
- ④ Enclosure drilled for 150–300 VA CPTs.

Box 1 will **not** accept devices with top-mounted auxiliaries. Box 2 will accept NEMA Sizes 00 and 0 starters with top-mounted auxiliaries.

Type 3R, 4X and 12 Enclosures

Type 3R Enclosure



Type 3R, 4X and 12 Enclosures—NEMA (Freedom)

| Starter Type | Box Number | NEMA Size AN16 | Type 3R Catalog Number | Type 12 Catalog Number | Type 4X Catalog Number |
|--|----------------|----------------|------------------------|------------------------|------------------------|
| Non-reversing starter | 5 | 00-1 | C799B21 | C799B81 | C799B41 |
| | 6 | 2 | C799B24 | C799B84 | C799B43 |
| | 6 | — | C799B25 | C799B85 | C799B44 |
| | 8 | 3 | C799B210 | C799B810 | C799B47 |
| | 8 | — | C799B212 | C799B812 | C799B49 |
| | 8 | 4 | C799B211 | C799B811 | C799B48 |
| | 10 | 5 | C799B218 | C799B818 | C799B413 |
| Non-reversing starter with space for CPT | 6 | 00-2 | C799B24 | C799B84 | C799B43 |
| | 6 | — | C799B25 | C799B85 | C799B44 |
| | 8 | 3 | C799B210 | C799B810 | C799B47 |
| | 8 | — | C799B212 | C799B812 | C799B49 |
| | 8 | 4 | C799B211 | C799B811 | C799B48 |
| | 10 | 5 | C799B218 | C799B818 | C799B413 |
| Reversing starter | 6 | 00-2 | C799B24 | C799B84 | C799B43 |
| | 6 | — | C799B25 | C799B85 | C799B44 |
| | 8 | 3 | C799B210 | C799B810 | C799B47 |
| | 8 | — | C799B212 | C799B812 | C799B49 |
| | 9 | 4 | C799B215 | C799B815 | C799B411 |
| | 10 | 5 | C799B218 | C799B818 | C799B413 |
| Multispeed | 7 ^① | 0-2 | C799B223 | C799B823 | C799B417 |

Enclosures—IEC (XT Type)

| Starter Type | Box Number | IEC Size | Catalog Number |
|--------------------------------------|------------|----------|----------------|
| XT starters, 15A and 25A, with reset | 1 | B-C | C799B31 |
| XT contactors/starters without reset | 1 | B-C | C799B33 |
| XT contactors/starters with reset | 2 | B-C-D | C799B36 |
| XT contactors/starters without reset | 2 | B-C-D | C799B34 |
| XT contactors/starters with resets | 1 | B-C | C799B35 |
| XT contactors/starters with resets | 2 | B-C-D | C799B37 |

Note

① Blank cover provided.

Lighting Contactors

Electrically Held Base Contactor for C30CN/ECC

The C30CNE20_0 electrically held base contactor contains a 2NO power pole as standard and will allow the addition of power poles to build an electrically held contactor up to 12 poles

maximum. A mechanically held module kit can also be added to convert the electrically held contactor into a mechanically held contactor in the field.

Electrically Held Base Contactor



Electrically Held Base Contactor

| Power Poles | Catalog Number ^① |
|-------------|-----------------------------|
| 2NO | C30CNE20_0 |

Coil Base Voltage (Digit 9)

| Voltage (Digit 9) | Code Suffix | Voltage (Digit 9) | Code Suffix |
|---------------------------|-------------|---------------------------|-------------|
| 115–120V 60 Hz/110V 50 Hz | A | 265–277V 60 Hz/240V 50 Hz | H |
| 230–240V 60 Hz/220V 50 Hz | B | 24V 60 Hz/20V 50 Hz | T |
| 460–480V 60 Hz/440V 50 Hz | C | 28V 60 Hz/24V 50 Hz | V |
| 575–600V 60 Hz/550V 50 Hz | D | 347V 60 Hz | X |
| 200–208V 60 Hz | E | | |

Power Poles for C30CNM/ECC

The C30CNM contactor accepts up to a maximum six single- or two-pole (or combinations) power poles. These can be used to form up to:

- 12 NO poles maximum when 6 two-poles are used in NO positions (1–6) or
- 8 NC poles maximum with 4 two-poles in the NC position (1–4) and 4 NO poles with 2 two-poles in the 2 NO positions (5–6)

Power Poles



Power Poles

| Power Poles | Catalog Number |
|-------------|----------------|
| Single-pole | C320PRP1 |
| Two-pole | C320PRP2 |

Mechanically Held Module Kits for C30CN/ECC

These kits are for converting electrically held contactors to mechanically held units. Kits include control module, latch, latch cover and auxiliary

contacts plus installation instructions. Conversion kits are suitable for coil voltages of 277V and below.

C30CNM Components—Exploded View

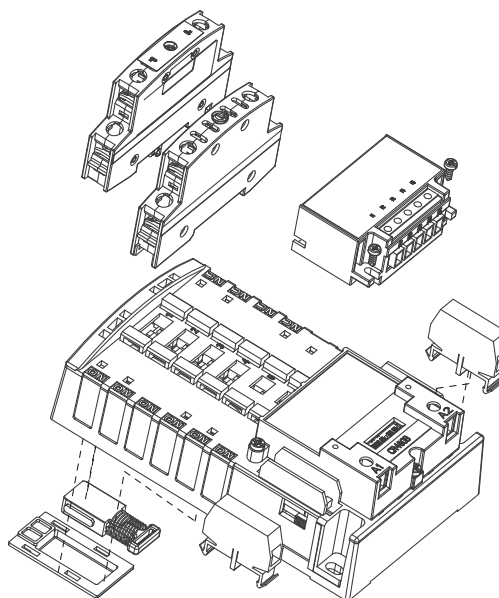

Conversion Kit



Mechanically Held Module Kits

| Coil Volts | Control Volts | Catalog Number |
|-------------------|---------------|----------------|
| Two-Wire | | |
| 24–277 Vac | 110–120 Vac | C320MH2WA0 |
| | 200–277 Vac | C320MH2WH0 |
| | 24 Vac | C320MH2WT0 |
| | 12–24 Vdc | C320MH2WT1 |
| Three-Wire | | |
| 24–277 Vac | 110–120 Vac | C320MH3WA0 |
| | 200–277 Vac | C320MH3WH0 |
| | 24 Vac | C320MH3WT0 |
| | 12–24 Vdc | C320MH3WT1 |

Note

- ^① When ordering, select required contactor by catalog number and replace the magnet coil alpha designation in the catalog number () with the proper code suffix from the Coil Base Voltage table above.

Auxiliary Contacts for C30CN/ECC

A mechanically held contactor with a two-wire control module uses 1NC auxiliary contact as standard for the control wiring circuit. The mechanically held contactor with a three-wire control

module uses 1NO-1NC auxiliary contacts as standard for the control wiring circuit. See the table below for possible additional auxiliary contact configurations.

Auxiliary Contact Configurations

| Two-Wire | Three-Wire |
|---------------------------------------|--------------------|
| None | 1NC (two-pole) |
| 1NO (single-pole) | 1NO (two-pole) |
| 2NO (two-pole) | 1NO-1NC (two-pole) |
| 1NC (two-pole) | |
| 1NO-1NC (NO single-pole, NC two-pole) | |
| 2NO-1NC (two-pole) | |

Auxiliary Contacts



Auxiliary Contacts

| Auxiliary Block | Catalog Number |
|-----------------|----------------|
| Single-pole | C320AMH1 |
| Two-pole | C320AMH2 |

Transient Suppressor Kits for CN35/ECL

10–60A Contactors

These kits limit high voltage transients produced in the control circuit when power is removed from the contactor or starter coil. There are three separate suppressors for use

on 24–120V, 240V or 480V coils respectively.

These devices mount directly to the coil terminals of lighting contactors 10–60A.

C320TS2



Kits for 10–60A

| Description | Coil Voltage | Catalog Number |
|----------------------|--------------|----------------|
| Transient suppressor | 24–120V | C320TS1 |
| | 240V | C320TS2 |
| | 480V | C320TS3 |

100–300A Contactors

This device mounts on top of any side-mounted auxiliary contact on lighting contactors 100–300A. It connects across coil terminals on any 120V contactor magnet coil.

Limits high voltage transients produced in the circuit when power is removed from the coil.

C320AS1



Kits for 100–300A

| Description | Coil Voltage | Catalog Number |
|----------------------|--------------|----------------|
| Transient suppressor | 120V | C320AS1 |

Auxiliary Contacts for CN35/ECL

CN35 lighting contactors include a 1NO maintaining auxiliary contact mounted on right hand side (on 10A, two- and three-pole devices, auxiliary contact occupies fourth power pole position—no increase in width). The 10–60A devices will accept additional auxiliary contacts on the top and/or sides.

Auxiliary contact blocks are designed for snap-on installation—fast, easy installation (no tools required up to 60A). All auxiliary

contacts are of the bifurcated design with parallel circuit paths. This redundant path provides very high reliability. Auxiliary contacts can be snapped on the side (up to two circuits—per auxiliary contact) and on the top (up to four circuits). Auxiliary contacts for larger contactors, 100–400A sizes, will accept side-mounted auxiliaries only and easily attach to the side of the contactor with two screws.

Contact Configuration Code

This two-digit code is found on the auxiliary contact to assist in identifying the specific contact configuration.

The first digit indicates the quantity of NO contacts and the second indicates the quantity of NC contacts.

Auxiliary Contacts—10–60A Contactors

| Description | Contact Configuration Code ^① | Catalog Number |
|---------------------------------|---|----------------|
| Side-Mounted | | |
| 1NO | 10 | C320KGS1 |
| 1NC | 01 | C320KGS2 |
| 1NO-1NC | 11 | C320KGS3 |
| 2NO | 20 | C320KGS4 |
| 2NC | 02 | C320KGS5 |
| Top-Mounted ^② | | |
| 1NO | 10 | C320KGT1 |
| 1NC | 01 | C320KGT2 |
| 1NO-1NC | 11 | C320KGT3 |
| 2NO | 20 | C320KGT4 |
| 2NC | 02 | C320KGT5 |
| 3NO | 30 | C320KGT9 |
| 2NO-1NC | 21 | C320KGT10 |
| 1NO-2NC | 12 | C320KGT11 |
| 3NC | 03 | C320KGT12 |
| 4NO | 40 | C320KGT13 |
| 3NO-1NC | 31 | C320KGT14 |
| 2NO-2NC | 22 | C320KGT15 |
| 1NO-3NC | 13 | C320KGT16 |
| 4NC | 04 | C320KGT17 |

Side-Mounted



Top-Mounted



Notes

^① For reference only—not part of catalog number.

^② Cannot be added to contactors or starters mounted in Box 1 (Type 1).

15.1

Accessories and Modification Codes

Accessories

Base Auxiliary Contact



Base Auxiliary Contacts—100–400A Contactors

| Circuit | Contact Configuration Code ^① | 100A Contactors Catalog Number | 200 and 300A Contactors Catalog Number |
|---------|---|--------------------------------|--|
| NO | 10 | C320KGS31 | C320KGS41 |
| NO-NC | 11 | C320KGS32 | C320KGS42 |

Auxiliary Contact

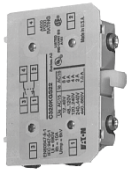

Auxiliary Contacts—100–400A Contactors

| Circuit | Contact Configuration Code ^① | Catalog Number |
|--------------------|---|----------------|
| NO | 10 | C320KGS20 |
| NC | 01 | C320KGS21 |
| NO-NC ^② | 11 | C320KGS22 |

Auxiliary Contact Ratings (Amperes)—NEMA A600

| Current | AC Volts | | | |
|-----------------------|----------|------|------|------|
| | 120V | 240V | 480V | 600V |
| Make and interrupting | 60.0 | 30.0 | 15.0 | 12.0 |
| Break | 6.0 | 3.0 | 1.5 | 1.0 |
| Continuous | 10.0 | 10.0 | 10.0 | 10.0 |

Auxiliary Contact 5A Continuous Thermal Rating—NEMA P300

| DC Volts | Make/Break Amperes |
|----------|--------------------|
| 125 | 1.10 |
| 250 | 0.55 |

Notes

- ^① For reference only—not part of catalog number.
- ^② NO-NC occupies two positions—L2 and L3 or R2 and R3. See table on **Page V10-T15-33**.

Auxiliary Contact Location for CN35/ECL

Auxiliary Contacts—Mounting Positions

The sketches below illustrate the maximum number of auxiliary contacts that can be assembled to a contactor and their locations in standard enclosures.

Auxiliary Contact Mounting Positions

| Size | Poles | Available Mounting Positions ①②③ | | |
|--------|-------|----------------------------------|--------------------|--------------------|
| | | Open Type | Type 1 | Type 3R, 4X, 12 |
| 10A | 2-4 | T1, L1, R1 | L1 | L1, T1 |
| 20-60A | 2-3 | T1, L1 | L1 | L1, T1 |
| 60A | 4 | T1, L1 | — | L1, T1 |
| 60A | 5 | T1, L1 | — | L1, T1 |
| 100A | 2-3 | R2, R3, L1, L2, L3 | R2, R3, L1, L2, L3 | R2, R3, L1, L2, L3 |
| 200A | 2-3 | R2, R3, L1, L2, L3 | R2, R3, L1, L2, L3 | R2, R3, L1, L2, L3 |
| 300A | 2-3 | R2, R3, L1, L2, L3 | R2, R3, L1, L2, L3 | R2, R3, L1, L2, L3 |
| 400A | 2-3 | R2, R3, L1, L2, L3 | R2, R3, L1, L2, L3 | R2, R3, L1, L2, L3 |

Auxiliary Contact Location

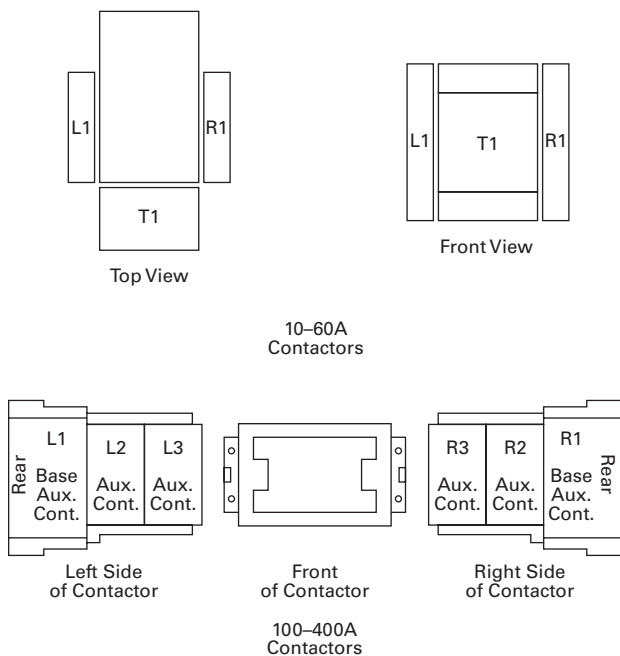

Pneumatic Timers—Top-Mounted for CN35/ECL

Attachment mounts on top of 10-60A lighting contactors (top-mounted auxiliary contacts cannot be installed on device when timer is used). Timer unit has DPST

timed contacts—circuits in each pole must be the same polarity. Units are convertible from OFF to ON delay or vice-versa.

Pneumatic Timer



Pneumatic Timers

| Timing Range | Catalog Number |
|----------------|----------------|
| 0.1-30 seconds | C320TP1 |
| 10-180 seconds | C320TP2 |

Maximum Ampere Ratings

| Description | Volts AC | | | |
|-------------|----------|------|------|-----|
| | 120 | 240 | 480 | 600 |
| Make | 30.0 | 15.0 | 7.5 | 6.0 |
| Break | 3.0 | 1.5 | 0.75 | 0.6 |

Solid-State Timers for CN35/ECL

Solid-State ON DELAY Timer—Side-Mounted on CN35 Freedom Series Lighting Contactors Through 60A

This timer is designed to be **wired in SERIES with the load** (typically a coil). When the START button is pushed (power applied to timer), the

ON DELAY timing function starts. At the completion of the set timing period, timer and series wired load will both be energized.

Solid-State Timer



Product Selection—Mounted Timer

| Timing Range | Catalog Number ④⑤⑥ |
|-----------------|---------------------|
| 0.1-1.0 seconds | C320TDN1_ |
| 1-30 seconds | C320TDN30_ |
| 30-300 seconds | C320TDN300_ |
| 5-30 minutes | C320TDN3000_ |

Notes

- ① Available positions on contactors or starters other than what is factory installed.
- ② When a pneumatic timer is mounted on contactor, only side-mounted auxiliary contact positions are available. The solid-state timer, when added, takes up side-mounted auxiliary contact position.
- ③ For 100-400A contactors, a base auxiliary contact must be added in position L1 before additional contacts can be mounted.
- ④ Add operating voltage suffix to catalog number. **A** = 120V, **B** = 240V, **E** = 208V.
- ⑤ Rated 0.5A pilot duty—not to be used on larger contactors.
- ⑥ Terminal connections are quick connects only. Two per side.

15.1

Accessories and Modification Codes

Accessories

Type J Auxiliary Contact for A202/ECL

- Capable of being field mounted in a contactor or starter (Classes A200, A900 Sizes 00–6, V200, V201 vacuum and definite purpose controllers)
- Provides two separate electrical contact sets which wire vertically and are color coded; black designates NC and silver designates NO. Please note that the vertical wiring is contrary to the horizontal wiring of the L-56 auxiliary contacts
- Designed to fit within dimensions of starter; no additional panel space is required
- Provides circuit isolation (no polarity restrictions) and single break bifurcated contacts

Auxiliary Contact Ratings

| Voltage | Make | Break |
|------------------|---------|--------|
| NEMA A600 | | |
| 120–600 Vac | 7200 VA | 720 VA |
| 72–120 Vac | 60A | 720 VA |
| 28–72 Vac | 60 VA | 10A |
| NEMA R300 | | |
| 28–300 Vdc | 28 VA | 28 VA |

Type J Auxiliary Contact



Auxiliary Contact Types

| Contact Type | Max. | Catalog Number |
|----------------------------|------|----------------|
| 1NO and 1NC | 4 | J11 |
| 2NC | 4 | J02 |
| 2NO | 4 | J20 |
| 1 coil clearing NC and 1NO | 4 | J1C |

SS-56 Surge Suppressor for A202/ECL

- Designed to be used with magnetic motor controllers through Size 4 in 120V, 60 Hz control circuit applications where electronic equipment is used
- Steady state coil volts: 120, 60 Hz, rms
- Peak input volts: 169.6, 60 Hz, max. amplitude
- Max. ambient temperature: 65°C
- Nominal limiting volts: 270 peak
- Nominal rate of volt rise: 0.5 per ms

SS-56 Surge Suppressor



Surge Suppressor^①

| Type Mounting | Kit Catalog Number |
|---------------|--------------------|
| Starter | SS-56 |

F-56 Fuse Block for A202/ECL

- Facilitates installation of fuses (15A, 600V maximum) in control circuits
- Uses Bussman type KTK fuses, or equivalent
- Mounts in same cavity as Type J auxiliary contact
- No tools or mounting hardware needed
- Fuse not included

Fuse Block

| Mounting | Kit Catalog Number |
|----------|--------------------|
| Starter | F56 |
| Panel | F56-P |

R-56 Interposing Relay for A202/ECL

The R-56AA interposing relay is a low energy solid-state device with a single NO solid-state contact. It can be used as a 120 Vac control relay, and will operate on as little as 40 Vac input. Is useful in

applications requiring long control wiring runs where excessive voltage drop would prevent the contactor or relay from energizing. Will operate a Size 4 contactor from 10,000 ft using 18 AWG wire.

Interposing Relay

| Type Mounting | Kit Catalog Number |
|------------------|--------------------|
| Starter or panel | R56-AA |

Power Pole Kit for A202/ECL

- Adds 1NO or 1NC power pole to Size 00–1 A201 Class contactors
- Factory installed or field mountable in load side auxiliary cavities
- 600 Vac
- Continuous current rating of 18A for Size 0, 27A for Size 1

Power Pole Kit^②

| Continuous Current Rating | Kit Size | Kit Catalog Number |
|---------------------------|----------|--------------------|
| Normally Open | | |
| 18 | 0 | PNO-0 |
| 27 | 1 | PNO-1 |
| Normally Closed | | |
| 18 | 0 | PNC-0 |
| 27 | 1 | PNC-1 |

Notes

- Can be used on Sizes 5 and 6 with 120V coil. Mounting bracket required—order separately. Mounting bracket 177C043G04.
- Do not use with DC operated contactors.

Replacement Auxiliary Contacts for A202/ECL**Replacement Auxiliary Contacts**

| Contactor Size | Contact Arrangement | Aux. Elect. Contact Catalog Number | Style Number |
|----------------|---------------------|------------------------------------|-------------------|
| 5, 6 | 1NO + 1NC | J11 | 9084A17G01 |
| | 2NO | J20 | 9084A17G02 |
| | 2NC | J02 | 9084A17G03 |
| 7, 8 | 1NO | — | 578D461G01 |
| | 1NC | — | 578D461G03 |
| 9 | 1NO + 1NC | — | 843D943G04 |
| | 2NO | — | 843D943G05 |
| | 2NC | — | 843D943G06 |

Extra Auxiliary Contact Kits for A202/ECL

All starters include an auxiliary contact with 1NO and 1NC contact. These kits include an auxiliary contact

with contacts as shown, plus operating arm and mounting bracket when required.

Extra Auxiliary Contact Kits

| Contactor Size | Contact Arrangement | Style Number |
|-------------------|---------------------|-------------------|
| 5, 6 | 1NO + 1NC | 3463D94G18 |
| | 2NO | 3463D94G04 |
| | 2NC | 3463D94G19 |
| 7, 8 ^① | 2NO | 818D498G06 |
| | 1NO | 818D498G04 |

DC Coil Conversion Kits for A202/ECL

Kits listed below include all necessary parts to convert from AC to DC control including the DC coil with

built-in diode, rectifier, auxiliary interlock and all mounting hardware.

DC Coil Conversion Kits

| Size | Voltage | Kit Style Number |
|------|---------|-------------------|
| 5 | 110-120 | 7864A28G01 |
| | 220-240 | 7864A28G02 |
| | 440-480 | 7864A28G03 |
| 6 | 110-120 | 7864A29G01 |
| | 220-240 | 7864A29G02 |
| | 440-480 | 7864A29G03 |

Note

① Size 7 and larger use DC coils as standard.

IT Solid-State Soft Starters

Surge Suppressors for S801+/S811+

The surge suppressor can mount on either the line or load side of the IT soft

starter. It is designed to clip the line voltage (or load side induced voltage).

Surge Suppressor



Surge Suppressors

| Description | Catalog Number |
|-------------------------------|----------------|
| 600V MOV for IT soft starters | EMS39 |
| 690V MOV for IT soft starters | EMS41 |

Lug Kits for S801+/S811+

The 200 mm and 290 mm soft starters do not include lugs.

The 200 mm and 290 mm soft starters each have different lug options based on

your wiring needs. Each lug kit contains three lugs which can be mounted on either the load or line side.

Lug Kits



Lug Kits

| Frame Size | Frame Designation | Description | Catalog Number |
|---|-------------------|---|----------------|
| 200 mm SSRV | T, U | 2 cable connections, 4 AWG to 1/0 cable | EML22 |
| | | 1 cable connection, 4/0 to 500 kcmil cable | EML23 |
| | | 2 cable connections, 4/0 to 500 kcmil cable | EML24 |
| | | 1 cable connection, 2/0 to 300 kcmil cable | EML25 |
| | | 2 cable connections, 2/0 to 300 kcmil cable | EML26 |
| | | 290 mm SSRV | V |
| 4 cable connections, 4/0 to 500 kcmil cable | EML30 | | |
| 6 cable connections, 4/0 to 500 kcmil cable | EML32 | | |
| 4 cable connections, 2/0 to 300 kcmil cable | EML33 ① | | |

Lug Cover Kits for S801+/S811+

Replacement covers for the T and V Frame are available in case of damage to the existing covers.

Lug Cover Kits

| Description | Catalog Number |
|----------------------|----------------|
| Lug cover T, U Frame | EML27 |
| Lug cover V Frame | EML34 |

Digital Interface Module and Control Interface Module

The Digital Interface Module (DIM) and control interface module are available as replacement parts.

DIM and CIM

| Description | Catalog Number |
|-----------------------------------|----------------|
| Blank cover (filler) | EMA68 |
| DIM for S811+ | EMA91 |
| CIM for S801+ | EMA71 |
| CIM for S801+ pump control option | EMA72 |
| Panel mounting kit | |
| 3 ft cable | EMA69A |
| 5 ft cable | EMA69B |
| 8 ft cable | EMA69C |
| 10 ft cable | EMA69D |

Control Wire Connector

Control Wire Connector

| Description | Catalog Number |
|---|----------------|
| 12-pin, 5 mm pitch connector for control wiring | EMA75L |

User Manual for S811+

A comprehensive user manual is available and can be downloaded free of charge

from www.eaton.com by performing a document search for MN03902002E.

Mounting Plates for S801+/S811+

The mounting plates are designed to help make it easy to install or retrofit the soft starter into enclosures and MCCs. The soft starter can

be mounted onto the plate prior to installation. The mounting plate is designed with tear drop mounting holes for easier installation.

Mounting Plates

| Description | Catalog Number |
|---------------------------|----------------|
| Mounting plate N Frame | EMM13N |
| Mounting plate R Frame | EMM13R |
| Mounting plate T, U Frame | EMM13T |
| Mounting plate V Frame | EMM13V |
| Fan/hood accessory | EMM18 |

Note

① The EML33 does not have a CSA Listing.

Adapter Plates

The adapter plate allows customers to retrofit a V Frame 290 mm soft starter with the U Frame 200 mm soft starter.

Adapter Plates

| Description | Catalog Number |
|-----------------------------|----------------|
| Adapter Plates ^① | EMM13U |

Vibration Plates for S801+/S811+

The vibration plates allow the soft starter to be applied in high shock and vibration applications. The vibration plate allows vibration up to 5g

and shock in up to 40g. The soft starter is mounted onto the vibration plate prior to installation in the panel.

Vibration Plates

| Description | Catalog Number |
|----------------------------|----------------|
| Vibration plate N Frame | EMM14N |
| Vibration plate R Frame | EMM14R |
| Vibration plate T, U Frame | EMM14T |
| Vibration plate V Frame | EMM14V |

Power Supplies

24 Vdc power supply that can be used with the S801+ or S811+ SSRV or as a standalone device.

Power Supplies

| Description | SSRV | Catalog Number |
|-------------------|-------------|----------------|
| 115 Vac input | S801+/S811+ | PSG240E |
| 230 Vac input | S801+/S811+ | PSG240E |
| 380–480 Vac input | S801+/S811+ | PSG240F |

DIN Rail Power Supply Mounting Kit (35 mm)**DIN Rail Mounting Kit**

| Description | Catalog Number |
|-------------------------------|----------------|
| DIN rail mounting kit (35 mm) | PSSDIN |

NEMA Vacuum Break Control**Lug Sizes**

- Size 4—12–4/0
- NEMA Size 5 and 6 and 320A, 540A and 610A—supplied without line or load lugs

Lug Kits—Consist of 6 Lugs

| Size | Description | Catalog Number |
|------------------|-----------------------------|----------------|
| 5 and 320A | 1/0–500 kcmil | C325KAL8 |
| 6, 540A and 610A | 1/0–500 kcmil double barrel | C325KAL9 |
| 610A | 1/0–600 kcmil double barrel | 80-19825-2 |

Field Modification Kits**Auxiliary Electrical Contacts**

Size 4—Three Type J auxiliary contacts may be mounted on the top of Size 4 contactors to provide six auxiliary, isolated 600V, 10A contacts for use in control circuits.

Sizes 5–6—Two Type J auxiliary contacts may be mounted on each side of Size 5 and 6 contactors to provide four auxiliary, isolated 600V, 10A contacts for use in control circuits.

Auxiliary Electrical Contacts

| Contact Arrangement | Catalog Number |
|---------------------|----------------|
| 1NO, 1NC | J11 |
| 2NO | J20 |
| 2NC | J02 |

Horizontal Mechanical Interlock

| Size | Catalog Number |
|------|----------------|
| 4 | 180C113G04 |
| 5 | 180C113G16 |
| 6 | 180C113G17 |

Note

^① For more information see Pub51719.

Heater Coils

Heater Coil Selection for Type B Overload Relay

Motor Full Load Current in Amperes for Use with 3 Heaters Only
Open Starter

| Ambient Compensated Overload Relay | Heater Catalog Number ① |
|------------------------------------|-------------------------|
| Size 4 and 160A | |
| 12.8–14.1 | FH68 |
| 14.2–15.5 | FH69 |
| 15.6–17.1 | FH70 |
| 17.2–18.9 | FH71 |
| 19.0–20.8 | FH72 |
| 20.9–22.9 | FH73 |
| 23.0–25.2 | FH74 |
| 25.3–27.8 | FH75 |
| 27.9–30.6 | FH76 |
| 30.7–33.5 | FH77 |
| 33.6–37.5 | FH78 |
| 37.6–41.5 | FH79 |
| 41.6–46.3 | FH80 |
| 46.4–50 | FH81 |
| 51–55 | FH82 |
| 56–61 | FH83 |
| 62–66 | FH84 |
| 67–73 | FH85 |
| 74–78 | FH86 |
| 79–84 | FH87 |
| 85–92 | FH88 |
| 93–101 | FH89 |
| 102–110 | FH90 |
| 111–122 | FH91 |
| 123–129 | FH92 |
| 130–133 | FH93 |
| — | FH94 |

Motor Full Load Current in Amperes for Use with 3 Heaters Only
Open Starter

| Ambient Compensated Overload Relay | Heater Catalog Number ① |
|--|-------------------------|
| Size 5 and 320A with 300/5 Current Transformers | |
| 107–117 | FH23 |
| 118–129 | FH24 |
| 130–141 | FH25 |
| 142–155 | FH26 |
| 156–170 | FH27 |
| 171–187 | FH28 |
| 188–205 | FH29 |
| 206–224 | FH30 |
| 225–244 | FH31 |
| 245–263 | FH32 |
| 264–292 | FH33 |
| 293–318 | FH34 |
| 319–350 | FH35 |
| Size 6 and 540A with 600/5 Current Transformers | |
| 236–259 | FH24 |
| 260–283 | FH25 |
| 284–310 | FH26 |
| 311–340 | FH27 |
| 341–374 | FH28 |
| 375–411 | FH29 |
| 412–448 | FH30 |
| 449–489 | FH31 |
| 490–527 | FH32 |
| 528–585 | FH33 |
| 586–600 | FH34 |

Notes

① Three are required per overload relay.

For information on H2001 heaters, see **Page V10-T15-6**.

Modification Codes

A—Ammeters, Auxiliary Contacts, Accelerating Relays, Autotransformers

| Modification | Description | Catalog Number Suffix |
|--|---|-----------------------|
| Ammeter | Panel type wired to current transformer in Line 1, Type 1, 12 | A1 |
| | Panel type wired to current transformer in Line 1, Type 3R, 4X | |
| | Panel type, selector switch and three current transformers wired to ammeter via switch, Type 1, 12 | A2 |
| | Panel type, selector switch and three current transformers wired to ammeter via switch, Type 3R, 4X | |
| | Miniature (single-phase), Type 1, 12 | A3 |
| | Miniature with selector switch, Type 1, 12 | A4 |
| | Switchboard (single-phase), Type 1, 12 | A5 |
| | Switchboard (single-phase), Type 3R, 4X | |
| | Switchboard with selector switch, Type 1, 12 | A6 |
| | Switchboard with selector switch, Type 3R, 4X | |
| | Three-panel type (single-phase), Type 1, 12 | A7 |
| | Three-panel type (single-phase), Type 3R, 4X | |
| | Three miniature (single-phase), Type 1, 3R, 4X, 12 | A10 |
| | Three switchboard type (single-phase), Type 1, 12 | A11 |
| Three switchboard type (single-phase), Type 3R, 4X | | |
| Ammeter order by description, Type 1, 3R, 4X, 12 | A12 | |
| Auto-transformers | Hp rating selection, see Tab 5 | A8 |
| | Order by description | A9 |
| Top-mounted auxiliary contacts ^① (unwired) | 1NO | A13 |
| | 1NC | A14 |
| | 1NO-1NC | A15 |
| NEMA Sizes 00–2 only (unwired) | 2NO | A16 |
| | 2NC | A17 |
| IEC Sizes B–L only (unwired) XT Series | 2NO-1NC | A18 |
| | 1NO-2NC | A19 |
| | 3NO | A20 |
| | 3NC | A21 |
| | 3NO-1NC | A22 |
| | 2NO-2NC | A23 |
| | 1NO-3NC | A24 |
| | 4NO | A25 |
| | 4NC | A26 |

Note

^① Top-mounted auxiliary contacts cannot be added to contactors in Box 1 (Type 1).

A—Ammeters, Auxiliary Contacts, Accelerating Relays, Autotransformers, continued

| Modification | Description | Catalog Number Suffix |
|--|---|--------------------------|
| Side-mounted auxiliary contacts ^① | 1NO | A27 |
| | 1NC | A28 |
| | 1NO-1NC | A29 |
| | 2NO | A30 |
| | 2NC | A31 |
| | 2NO-1NC | A32 |
| | 1NO-2NC | A33 |
| | 3NO | A34 |
| | 3NC | A35 |
| | 3NO-1NC | A36 |
| | 2NO-2NC | A37 |
| | 1NO-3NC | A38 |
| | 4NO | A39 |
| | 4NC | A40 |
| Auxiliary contacts | Contacts mounted on operating mechanism of disconnect switch, 1NO-1NC | A42 |
| | Contacts mounted on operating mechanism of disconnect switch, 2NO-2NC | A43 |
| | With auxiliary contact omitted | A44 |
| Accelerating relay | For two-speed | A46 |
| | 2NO/2NC 24 Vdc auxiliary relay— IT only | A47 |

B—Breaker Modifications, Backspin Timer, Undervoltage Release, Bell Alarm, Bus Choke

| Modification | Description | Catalog Number Suffix |
|----------------------|--|--------------------------|
| Breaker | 1NO-1NC auxiliary contact on breaker | B1 |
| | 2NO-2NC auxiliary contacts on breaker | B2 |
| | Shunt trip on circuit breaker—48–127 Vac or Vdc | B3 |
| | Shunt trip on circuit breaker—9–24 Vac or Vdc | B4 |
| | Shunt trip on circuit breaker—208–380 Vac | B5 |
| | Shunt trip on circuit breaker—415–600 Vac or 220–250 Vdc | B6 |
| | Undervoltage release for breaker | B8 |
| | Current limiter mounted to breaker | B9 |
| | Breaker—order by description | B10 |
| | Thermal magnetic breaker | B11 |
| | Backspin timer | 180 seconds |
| Undervoltage release | Undervoltage release for circuit breaker—208–240 Vac | B13 |
| | Undervoltage release for circuit breaker—380–480 Vac | B14 |
| | Undervoltage release for circuit breaker—525–600 Vac | B15 |
| Bell alarm | Bell alarm for circuit breaker | B16 |

Note

^① Available on **XT** starters for 40A and greater only.

C—Control Power Transformer, Power Supplies, Control Relays, Cover Control (not elsewhere defined), Current Transformers, Compelling Relay, Control Wiring, Control Circuit Breaker, Separate Control, Customer-Supplied Components, Contactors, Counter, E-Stop Relay, DC/AC Interface, Separate Source Disconnect, Bypass Contactors

| Modification | Description | Catalog Number Suffix |
|--|---|------------------------------------|
| Control power transformers | Standard size control transformer, 120V/60 Hz, 110V/50 Hz secondary with two primary and one secondary fuse | C1 |
| Make sure eighth character specifies primary/secondary voltage | Standard size control transformer, 24V/60 Hz secondary with two primary and one secondary fuse | C2 |
| | 50 VA extra capacity CPT 120V/60 Hz, 110V/50 Hz with two primary and one secondary | C42 |
| | 100 VA extra capacity CPT, 120V/60 Hz, 110V/50 Hz secondary with two primary and one secondary fuse | C3 |
| | 100 VA extra capacity CPT, 24V/60 Hz secondary with two primary and one secondary fuse | C4 |
| | 200 VA extra capacity CPT, 120V/60 Hz, 110V/50 Hz secondary with two primary and one secondary fuse | C5 |
| | 200 VA extra capacity CPT, 24V/60 Hz secondary with two primary and one secondary fuse | C6 |
| | 300 VA extra capacity CPT, 120V/60 Hz, 110V/50 Hz secondary with two primary and one secondary fuse | C7 |
| | 400 VA extra capacity CPT, 120V/60 Hz, 110V/50 Hz secondary with two primary and one secondary fuse | C8 |
| | 1 kVA extra capacity CPT, 120V/60 Hz, 110V/50 Hz secondary with two primary and one secondary fuse | C9 |
| | 2 kVA extra capacity CPT, 120V/60 Hz, 110V/50 Hz secondary with two primary and one secondary fuse | C10 |
| | Control transformer—order by description | C11 |
| | CPT with power supply for XT | C34 |
| | Power supplies (XT only) | Separate control 120 Vac to 24 Vdc |
| Power supply with extra capacity—order by description | | C28 |
| Control relays | Four-pole interposing relay, 600V (2NO/2NC) | C12 |
| | Four-pole, unwired, A600 rtg.—2NO-2NC | C14 |
| | Eight-pole, unwired, A600 rtg.—4NO-4NC | C15 |
| | Control relay—order by description | C16 |
| | Three-wire control module (C30 lighting) | C18 ① |
| | Two-wire control relay for mechanical/magnetic lighting contactors | C20 ① |
| Cover control | Convert position seven to E30 type cover control | C17 |
| | Lock-off attachment added on cover control | C19 |
| | Change to M22 (22 mm) cover controls | C29 |
| Current transformer(s) | In phase 1 | C21 |
| | In phases 1 and 2 | C22 |
| | In 3 phases | C23 |
| Compelling relay | — | C25 |
| Control wiring | Omit control wiring | C26 |
| | With separate control wiring and two 250V fuses in holder | C30 |
| | With common control wiring and two 600V (Class C) fuses in holder | C31 |
| | Control wiring type—order by description | C33 |
| Control circuit breaker | Order by description | C32 |
| Separate control | Wired for separate control (reduced voltage) | C35 |
| Customer supplied components | Customer supplied components to be installed | C36 |
| | Customer supplied wiring diagram to use | C37 |

Note

① Not available for **XT** starters.

Modification Codes

C—Control Power Transformer, IT Power Supplies, Control Relays, Cover Control (not elsewhere defined), Current Transformers, Compelling Relay, Control Wiring, Control Circuit Breaker, Separate Control, Customer-Supplied Components, Contactors, Counter, E-Stop Relay, DC/AC Interface, Separate Source Disconnect, Bypass Contactors, continued

| Modification | Description | Catalog Number Suffix |
|--------------------------------------|--|-----------------------|
| Contactors/starter | Contactors/starter—order by description | C40 |
| Counter | Operations counter | C41 |
| E-stop relay | E-stop relay (DeviceNet) | C43 |
| DC/AC interface | DC/AC interface module | C44 ① |
| Separate source disconnect | IEC separate source disconnect for control circuitry | C45 |
| Bypass contactors for IT RVSS | Isolation contactor | C46/J1 |
| | Output contactor | C46/J2 |
| | Bypass contactor | C46/J3 |
| | Isolation/output/bypass contactor | C46/J4 |

D—Device Labels, Deceleration Relay, Drain and Breather, Duplex Modifications

| Modification | Description | Catalog Number Suffix |
|---|---|-----------------------|
| Device labels | (Each label) | D1 |
| Decel. relay ① | Two-speed | D2 |
| Drain and breather (Type 7/9 enclosure) ① | Drain and breather | D5 |
| | Drain only | D6 |
| | Breather only | D7 |
| Duplex modifications | Alternator omitted (deduct price) | D12 |
| | START/STOP pushbuttons—supplied for each motor | D14 |
| | HAND/OFF/AUTO selector switch—supplied for each motor | D15 |
| | No. 1 lead—No. 2 lead selector switch for manual selection of lead pump (alternator is omitted) | D16 |
| | Red RUN pilot light—supplied for each motor | D17 |
| | Push-to-test red RUN pilot light—supplied for each motor | D18 |
| | TEST pushbutton for each motor | D19 |
| | CPT, 120V secondary, two primary fuses and one secondary fuse—supplied for each motor | D20 |
| | CPT with 100VA extra capacity, 120V secondary, two primary fuses and one secondary fuse—supplied for each motor | D21 |
| | CPT with 200VA extra capacity, 120V secondary, two primary fuses and one secondary fuse—supplied for each motor | D22 |
| | CPT for duplex—order by description | D23 |
| | Add two relays to modify controller to operate with single-pole pilot devices | D24 |
| | Add three relays to modify controller to operate with single-pole pilot devices | D25 |
| | Green—OFF for each starter | D26 |
| | Green—push-to-test OFF for each starter | D27 |
| | Green—RUN light (duplex pump) | D28 |
| Red—STOP light (duplex pump) | D29 | |
| P-T—green RUN light (duplex pump) | D30 | |
| P-T—red STOP light (duplex pump) | D31 | |
| Elapsed time meter (duplex pump) | D32 | |

Note

① Not available for **XT** starters.

E—Enclosure Modifications, Elapsed Time Meter, Duplex Outlet, Enclosure for Starter, Enclosure Clear Cover, Enclosure Material

| Modification | Description | Catalog Number Suffix |
|-------------------------------------|--|-----------------------|
| Enclosure modifications | Oversize enclosure | E3 |
| | Enclosure—order by description | E4 |
| | Enclosure with pole mounting hardware | E5 |
| | Removable end plates | E6 |
| | Service entrance rating (ground/neutral banding SE labels) | E7 |
| | Service entrance rating with ground bar | E8 |
| | Safety door interlock | E11 |
| Elapsed time meter | Wired across coil, Type 1, 12 | E9 |
| | Wired across coil, Type 3R, 4X | |
| | Elapsed time meter—order by description | E10 |
| Duplex outlet | Convenience duplex outlet mounted in side of enclosure | E12 |
| Enclosure for starter ^① | Horizontal combination starter, Size 0–2 | E13 |
| | Narrow combination starter, Size 0–2 | E14 |
| Enclosure clear cover for XT | Clear cover for Halyester enclosure non-metallic | E19 |
| Enclosure material | Convert to 316 stainless steel | E16 |
| | Convert from Type 3R to stainless steel | E21 |
| Irrigation pump panel | Bottom entry | E17 |

F—Fuse Clips, Fuse Blocks, Fungus Protection, Fingerproof Covers, EMI Filter

| Modification | Description | Catalog Number Suffix |
|-------------------------|--|-----------------------|
| Fuse clips ^① | Change fuse clips in position eight to Class J | F1 |
| | Change fuse clips in position eight to Class H and K (30A and 60A only) | F2 |
| Fuse blocks | Power fuses included—order by description | F4 |
| | 30A control circuit fuseholder (KTK) mounted on panel (unwired), fuse not supplied | F5 |
| | 30A control circuit fuseholder mounted on panel (unwired), FNQR fuse supplied | F6 |
| | Three-pole power fuseholder mounted on front contactor | F7 |
| | Separate fusing of control power supply— IT . | F8 |
| | Blown fuse indicator (not for PFC) | F10 |
| | Class CC fuses | F21 |

G—Ground Fault Relay, Grounding

| Modification | Description | Catalog Number Suffix |
|--------------------|--|-----------------------|
| Ground fault relay | Ground fault relay (wired) | G1 |
| | Ground fault relay (unwired) | G3 |
| Grounding | Special grounding—order by description | G5 |
| | Ground fault protection and monitoring panel | G7 |

Note

^① Not available for **XT** starters.

Modification Codes

H—Heater (Space), Heater Packs Installed

| Modification | Description | Catalog Number Suffix |
|---------------------------------------|-------------------------------|-----------------------|
| Space heater | Space heater and thermostat | H1 |
| | Space heater and NC interlock | H2 |
| Install heater packs (Freedom Series) | Class 20 | Class 10 |
| | /D1 H2001B-3 | /D25 H2101B-3 |
| | /D2 H2002B-3 | /D26 H2102B-3 |
| | /D3 H2003B-3 | /D27 H2103B-3 |
| | /D4 H2004B-3 | /D28 H2104B-3 |
| | /D5 H2005B-3 | /D29 H2105B-3 |
| | /D6 H2006B-3 | /D30 H2106B-3 |
| | /D7 H2007B-3 | /D31 H2107B-3 |
| | /D8 H2008B-3 | /D32 H2108B-3 |
| | /D9 H2009B-3 | /D33 H2109B-3 |
| | /D10 H2010B-3 | /D34 H2110B-3 |
| | /D11 H2011B-3 | /D35 H2111B-3 |
| | /D12 H2012B-3 | /D36 H2112B-3 |
| | /D13 H2013B-3 | /D37 H2113B-3 |
| | /D14 H2014B-3 | /D38 H2114B-3 |
| | /D15 H2015B-3 | /D39 H2115-3 |
| | /D16 H2016B-3 | /D40 H2116-3 |
| | /D17 H2017B-3 | /D41 H2117-3 |
| | /D18 H2018-3 | |
| | /D19 H2019-3 | |
| | /D20 H2020-3 | |
| | /D21 H2021-3 | |
| | /D22 H2022-3 | |
| | /D23 H2023-3 | |
| | /D24 H2024-3 | |

K—Keypad

| Modification | Description | Catalog Number Suffix |
|--------------|----------------------------|-----------------------|
| Keypad | Door mounted keypad (RVSS) | K5 |

L—Labels and Lighting Contactors

| Modification | Description | Catalog Number Suffix |
|---------------------|---|------------------------------|
| Lighting arrestor | Lighting arrestor installed in enclosure on panel | L3 |
| Lugs | Special lugs (order by description) | L9 |
| Carton label | Customer marking—specify | L10 |
| Lighting contactors | 1 NC pole | L21 |
| | 2 NC pole | L22 |
| | 3 NC pole | L23 |
| | 4 NC pole | L24 |
| | 5 NC pole | L25 |
| | 6 NC pole | L26 |
| | 7 NC pole | L27 |
| | 8 NC pole | L28 |
| | Three-wire 120 Vac | L29A |
| | Three-wire 240 Vac | L29B |
| | Three-wire 24 Vac | L29C |
| | Three-wire 24 Vdc | L29D |
| | Two-wire 120 Vac | L29E |
| | Two-wire 240 Vac | L29F |
| Two-wire 24 Vac | L29G | |

N—Nameplates

| Modification | Description | Catalog Number Suffix |
|---------------------|----------------------|------------------------------|
| Nameplates | Enclosure nameplates | N1 |

15.2

Accessories and Modification Codes

Modification Codes

P—Pilot Lights, Pushbuttons, Phase Relays, Potential Transformers, Power Factor Correction Capacitors, Program Timer, Percentage Timer, Photocell

| Modification | Description | Catalog Number Suffix |
|---|--|-----------------------|
| Push-to-test pilot lights | Push-to-test pilot light (red RUN) wired to coil | P1 |
| | Push-to-test pilot light (green OFF) wired in series with auxiliary contact | P2 |
| | Combination of P1 and P2 above | P3 |
| | Push-to-test pilot light (amber RUN) wired to coil | P4 |
| | Push-to-test pilot light—green RUN | P49 |
| | Push-to-test pilot light—green STOP | P57 |
| Pushbuttons | EMERGENCY STOP—mushroom head | P5 |
| | Pushbutton omitted | P6 |
| | START/STOP | P7 |
| | ON/OFF | P8 |
| | START | P9 |
| | ON | P10 |
| | OFF | P11 |
| | FORWARD/REVERSE/STOP | P12 |
| | FAST/SLOW/STOP | P13 |
| | FAST/OFF/SLOW | P14 |
| | HIGH/LOW/STOP | P15 |
| | HIGH/LOW | P16 |
| | SLOW/FAST | P17 |
| | Pushbutton with legend plate | P18 |
| | UP/STOP/DOWN | P52 |
| | OPEN/STOP/CLOSE | P53 |
| | Red STOP pushbutton | P72 |
| START/STOP pushbuttons (located in top two holes) | P73 | |
| Green START pushbutton | P74 | |
| Pilot lights | With one amber pilot light marked POWER AVAILABLE wired to load side of two fuses or circuit breaker | P19 |
| | Pilot light (amber RUN) wired to coil | P20 |
| | With one red pilot light marked RUN wired thru NO auxiliary contact | P21 |
| | With one push-to-test red light marked RUN Wired thru NO auxiliary contact | P22 |
| | Pilot light—red RUN | P23 |
| | Pilot light—red ON | P24 |
| | Pilot light—green OFF | P25 |
| | Pilot light—order by description | P26 |
| | Pilot light—red STOP | P29 |
| | Pilot light—green STOP | P61 |
| | FORWARD/REVERSE red pilot lights | P62 |
| | UP/DOWN red pilot lights | P63 |
| | OPEN/CLOSE red pilot lights | P64 |
| | HIGH/LOW red pilot lights | P65 |
| | FAST/SLOW red pilot lights | P66 |
| | Green RUN light | P67 |
| | LED bulbs | P68 |
| | Blue OVERLOAD light | P69 |
| | Amber fault pilot light | P71 |

P—Pilot Lights, Pushbuttons, Phase Relays, Potential Transformers, Power Factor Correction Capacitors, Program Timer, Percentage Timer, Photocell, continued

| Modification | Description | Catalog Number Suffix |
|------------------------------------|---|--|
| Illuminated pushbutton | Illuminated pushbutton—order by description | P27 |
| Phase loss relay | Phase loss relay | P28 |
| Phase reversal relay | Phase reversal relay | P30 |
| Phase unbalance relay | Phase unbalance relay | P32 |
| Phase monitoring relay | Phase monitoring relay | P34 |
| Power factor correction capacitors | /F1 20 kVar /F9 70 kVar /F17 200 kVar /F2 25 kVar /F10 75 kVar /F18 225 kVar /F3 30 kVar /F11 80 kVar /F19 250 kVar /F4 35 kVar /F12 90 kVar /F20 300 kVar /F5 40 kVar /F13 100 kVar /F21 350 kVar /F6 45 kVar /F14 125 kVar /F22 400 kVar /F7 50 kVar /F15 150 kVar /F8 60 kVar /F16 175 kVar | P38 |
| Potential transformers | Potential transformer—wired L1–L2 Potential transformer—wired L1– L2 and L2–L3 Potential transformer—three phases | P39 P40 P41 |
| Pump controller | Pump controller for <i>IT</i> . | P42 |
| Program timers | 15-minute program timer 24-hour program timer 7-day program timer with day omission feature | P43 P44 P45 |
| Percentage timers | 15-minute percentage timer 60-minute percentage timer | P47 P48 |
| Photocell | Photoelectric receptacle with photocell | P70 |

Q—IQ Products, DN50

| Modification | Description | Catalog Number Suffix |
|-------------------------|-------------------------------|------------------------------|
| IQ products | IQ 500 | Q1 |
| | IQ100 | Q2 |
| | IQ 1000 | Q3 |
| | IQ 4000 | Q5 |
| IQ data metering module | IQ data metering module | Q12 |
| | IQ 220 with cable | Q14 |
| DN50 | DeviceNet input/output module | Q13 |

R—Ramp, Relays, Solid-State Electronic Overload Relays, Resets, Overload Relay Modifications, Reversing, DeviceNet Interface

| Modification | Description | Catalog Number Suffix |
|---------------------|------------------------------|------------------------------|
| Ramp | Extended ramp of <i>IT</i> . | R1 |
| Relay | Overvoltage relay | R2 |
| | Omit overload relay | R4 |

R—Ramp, Relays, Solid-State Electronic Overload Relays, Resets, Overload Relay Modifications, Reversing, DeviceNet Interface, continued

| Modification | IEC Size | NEMA Size | Full Load Current Adjustment Range (A) | Three-Phase without Ground Fault Auto/Manual Reset Overload Selectable Class 10/20/30 | Three-Phase with Ground Fault Auto/Manual Reset Overload Selectable Class 10/20/30 |
|--|------------|-----------|--|---|--|
| Solid-state electronic overload relay ^① | B and C | 00 | 0.33–1.65 ^② | R63/A | R64/A |
| | | | 1–5 | R63/B | R64/B |
| | | | 4–20 | R63/C | R64/C |
| | C and D | 0 and 1 | 0.33–1.65 ^② | R63/A | R64/A |
| | | | 1–5 | R63/B | R64/B |
| | | | 4–20 | R63/C | R64/C |
| | | | 9–45 | R63/D | R64/D |
| | D | 2 | 9–45 | R63/D | R64/D |
| | D, F and G | 3 | 20–100 | R63/E | R64/E |
| | G | 4 | 28–140 | R63/F | R64/F |
| | N/A | 5 | 60–300 ^③ | R63/G | R64/G |
| | N/A | 6 | 120–600 ^④ | R63/H | R64/H |

| Modification | Description | Catalog Number Suffix |
|------------------------|--|-----------------------|
| Resets ^⑤ | Change external reset to internal reset—hole covered with plug | R5 |
| | Internal reset—no hole plug | R6 |
| | Overload reset (order by description) | R7 |
| | Manual reset only on overload relay | R44 |
| | Auto reset only on overload relay | R45 |
| | Internal trip indicator—no external reset | R47 |
| | External reset with external trip indicator | R48 |
| | External reset with bell alarm | R49 |
| | N3R reset boot added (Type 1/12 only) | R71 |
| Reversing ^⑥ | Reversing contactor/starter | R54 |
| Overload relay mods | Anti plug-in | R53 |
| DeviceNet interface | DeviceNet interface | R69 |
| | Standard reset for DeviceNet | R65 |
| | Lighted reset for DeviceNet | R66 |
| | Trip indicator for DeviceNet | R67 |

Notes

^① Features:

- Self-powered
- Phase loss protection
- Current adjustment knob
- ±1% repeat accuracy
- 1NO and 1NC isolated contacts

^② Not UL Listed.

^③ NEMA Size 5 starter available with 60–300A panel mounted CTs. Starter as an assembled unit with 1–5A C440 overload relay (C440A1A005SELAX or C440A2A005SELAX).

^④ NEMA Size 6 starter available with 120–600A panel mounted CTs. Starter as an assembled unit with 1–5A C440 overload relay (C440A1A005SELAX or C440A2A005SELAX).

^⑤ Not available for **XT** starters.

S—System Voltage, Selector Switches, Suppressor, Incomplete Sequence Protection, Single-Phase Jumper, Surge Capacitor, Speed Potentiometer

| Modification | Description | Catalog Number Suffix |
|--|--|------------------------------|
| System voltage selection | System voltage selection for internal components | S1 |
| | /H1 208V 60 Hz | |
| | /H2 240V 60 Hz | |
| | /H3 277V 60 Hz, single-phase | |
| | /H4 480V 60 Hz | |
| | /H5 600V 60 Hz | |
| | /H6 796V 60 Hz | |
| | /H7 220V 50 Hz | |
| | /H8 380V 50 Hz | |
| | /H9 415V 50 Hz | |
| | /H10 550V 50 Hz | |
| | /H11 660V 50 Hz | |
| | /H12 380V 60 Hz | |
| | /H13 1500V 60 Hz | |
| | System voltage selection—specify on order | S2 |
| Selector switches ^① | HAND/OFF/AUTO | S3 |
| | HAND/AUTO | S4 |
| | HAND/OFF/AUTO selector switch with one red RUN pilot light | S5 |
| | RUN/OFF/AUTO | S6 |
| | AUTO/OFF/TEST | S7 |
| | AUTO/OFF/TEST selector switch with one red RUN pilot light | S8 |
| | AUTO/OFF/TEST selector switch with one red RUN pilot light and one green pilot light | S9 |
| | OFF/AUTO | S10 |
| | START/STOP | S11 |
| | OFF/ON | S12 |
| | HIGH/LOW | S13 |
| | FAST/OFF/SLOW | S14 |
| | SLOW/FAST | S15 |
| | FORWARD/REVERSE | S16 |
| | HIGH/OFF/LOW | S17 |
| | HIGH/LOW/OFF/AUTO | S18 |
| | Selector switch omitted (pumps only) | S19 |
| | HAND/OFF/AUTO spring return from left | S21 |
| | OPEN/OFF/CLOSE | S41 |
| | FORWARD/OFF/REVERSE | S42 |
| | FAST/OFF/SLOW/AUTO | S43 |
| Selector switch omitted (pump panels only) | S19 | |
| Selector switch—order by description | S40 | |
| RVSS/BYPASS (soft starters only) | S44 | |
| LOCAL/REMOTE selector switch | S45 | |
| RUN/OFF selector switch | S46 | |
| Suppressor | Transient suppressor mounted on magnet coil | S24 |
| Surge suppression | MOV (IT) | S20 |
| Sequence timer | Sequence timer (pump panels) | S26 |
| Sequence protection | Incomplete sequence protection | S27 |
| Pump | 480V BP9000 pump | S28 |
| Single-phase | Convert contactor or starter from three-phase to single-phase—install jumper | S29 |
| | Single-phase rev. 120V | S30 |
| | Single-phase rev. 240V | S31 |
| Surge capacitor | Surge capacitor wired to disconnect line side | S37 |

Note

^① When using three-position selector switch with magnetic lighting contactor, mod **C20** must also be used (ECL04, ECL13, ECL15).

15.2

Accessories and Modification Codes

Modification Codes

T—Timers, Time Delay Relays, Terminal Blocks, Terminal Points, Ring Lug Connections

| Modification | Description | Catalog Number Suffix |
|----------------------|--|-------------------------|
| Timers | Pneumatic timer installed on contactor, unwired, 30 seconds maximum | T1 |
| | Pneumatic timer installed on contactor, unwired, 180 seconds maximum | T2 |
| | Pneumatic timer mounted in enclosure, unwired, 180 seconds maximum | T3 |
| | Solid-state ON delay timer (1–30 seconds) | T4 |
| | Solid-state ON delay timer (30–300 seconds) | T5 |
| | Timer—order by description | T25 |
| Time delay relays | Time delay relay, 3 minutes maximum, unwired, ON DELAY | T6 |
| | Time delay relay, 3 minutes maximum, unwired, OFF DELAY | T7 |
| | Time delay low voltage release relay | T8 |
| Terminal blocks | With one single circuit terminal block, unwired | T9 |
| | With two single circuit terminal block, unwired | T10 |
| Terminal points | With 6 terminal points, unwired | T11 |
| | With 12 terminal points, unwired | T12 |
| | With 18 terminal points, unwired | T13 |
| | Terminal point per customer specification, unwired (price each) | T14 |
| | Terminal point per customer specification, wired (unwired without customer diagram) | T15 |
| | Three terminals mounted between contactor and overload for power factor capacitors—Sizes 0–2 | T21 |
| | Three terminals mounted between contactor and overload for power factor capacitors—Sizes 3–4 | T22 |
| | Quick-connect terminals added to DP contactor/starter | T23 |
| Ring lug connections | Ring lug connections on power wires | T16 ^① |
| | Ring lug connections on control wires | T17 |

15 U—Undervoltage Relay, Time Delay Undervoltage Relay

| Modification | Description | Catalog Number Suffix |
|--------------------------------|---|-----------------------|
| Undervoltage relays | Undervoltage relay, non-adjustable | U1 |
| | Undervoltage relay, adjustable | U2 |
| Time delay undervoltage relays | Time delay undervoltage relay, non-adjustable | U4 |
| | Time delay undervoltage relay, adjustable | U5 |
| Under- and overvoltage relay | Under- and overvoltage relay | U7 |

Note

① Not available for **XT** starters.

V— Voltmeter, Varmeter, Vacuum Starter

| Modification | Description | Catalog Number Suffix |
|---------------------|---|----------------------------------|
| Voltmeters | One panel type voltmeter wired L1–L2 | V1 |
| | Panel type voltmeter and selector switch wired to read three-line voltages | V2 |
| | Miniature voltmeter wired L1–L2 | V3 ① |
| | Miniature voltmeter and selector switch wired to read three-line voltages | V4 ① |
| | Switchboard type voltmeter wired L1 – L2 | V5 |
| | Switchboard type voltmeter and selector switch wired to read three-line voltage | V6 ① |
| | Three panel type voltmeters wired in each phase | V7 |
| | Three miniature voltmeters wired in each phase | V8 ① |
| | Three switchboard type voltmeters wired in each phase | V9 ① |
| | Voltmeter—order by description | V10 |
| Varmeter ② | Varmeter | V11 |
| | Varmeter—order by description | V12 |
| Vacuum starter ② | Vacuum starter—1500V rating | V13 |

W— Wattmeter, Watt-Hour Meter, Wiremarkers, Wiring Diagram

| Modification | Description | Catalog Number Suffix |
|----------------------|---|----------------------------------|
| Wattmeter ① | Wattmeter | W1 |
| Watt-hour meter ① | Watt-hour meter | W3 |
| | Watt-hour meter with demand attachment | W5 |
| Wiremarkers | Wiremarkers | W7 |
| | Wiremarkers—order per customer diagram or specifications | W8 |
| | Wiremarkers—order by description | W9 |
| WYE-Delta hp | See Tab 5 | W10 ② |
| Windows in enclosure | Enclosure windows | W11 |
| Wiring diagram | Reduced copy of custom wiring diagram laminated on inside of door | W12 |

Notes

① Type 1/12 only.

② Not available for **XT** starters.