

Connector

Micro SIM Cover - 8 Pin

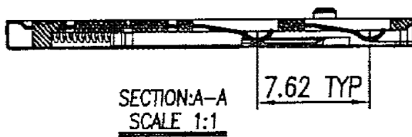
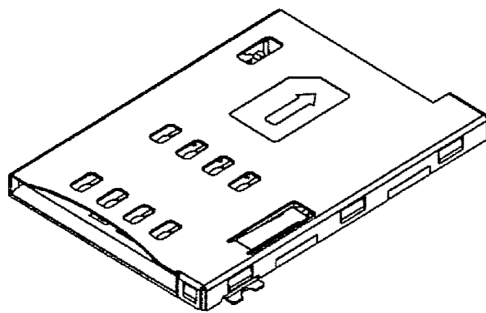

Specifications:

Connector Type	: SIM Socket
No. of Contacts	: 8
Pitch Spacing	: 1.27mm
Contact Material	: Copper
Contact Plating	: Gold
Contact Termination	: Surface Mount Right Angle

General Characteristics:

Mounting System	: SMT
Durability	: 3,000 Cycles Min.

Electrical Characteristics

Contact resistance	: 50mΩ typical, 100mΩ Max.
Insulation Resistance	: >1,000MΩ / 500V DC
Operation	: Normally open

Environmental Characteristics:

Operating Temperature	: -40°C to +85°C
Operating Humidity	: 10% to 95%RH
Storage Temperature	: -40°C to +85°C
Storage Humidity	: 10% to 95%RH
Thermal Shock	: -40°C to +85°C, 5 Cycles
Damp Heat	: 40°C, 90%RH, 10 days
Salt-mist	: 35°C, 5%, NaCl, 24H

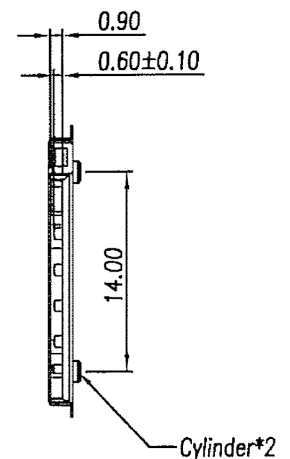
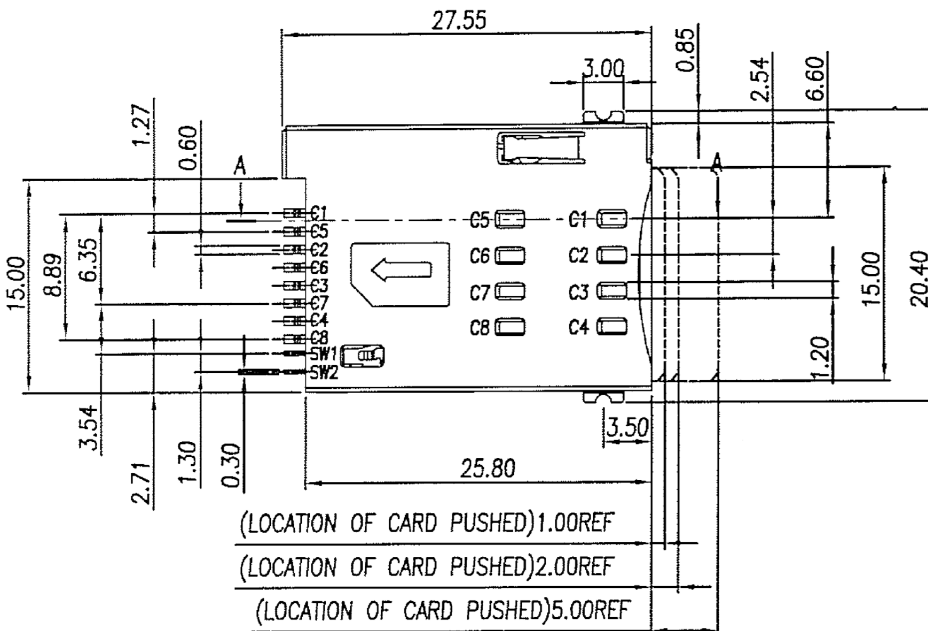

Dimensions : Millimetres

www.element14.com
 www.farnell.com
 www.newark.com



Connector

Micro SIM Cover - 8 Pin

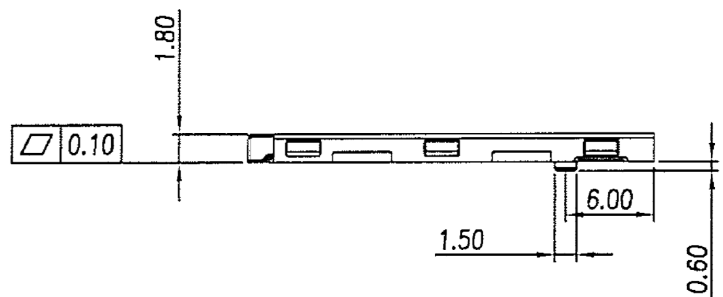
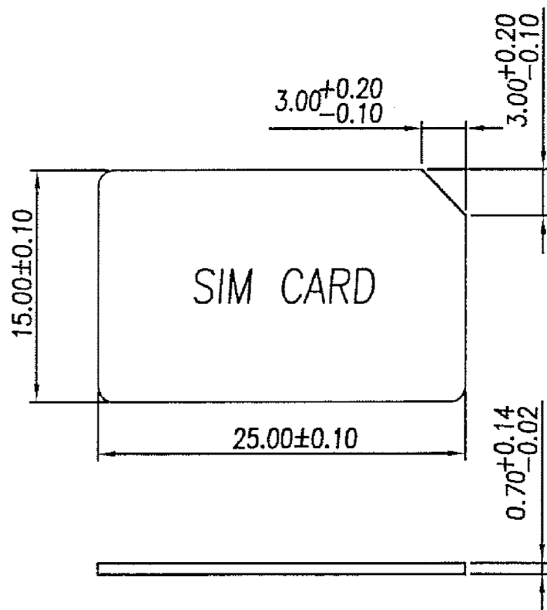
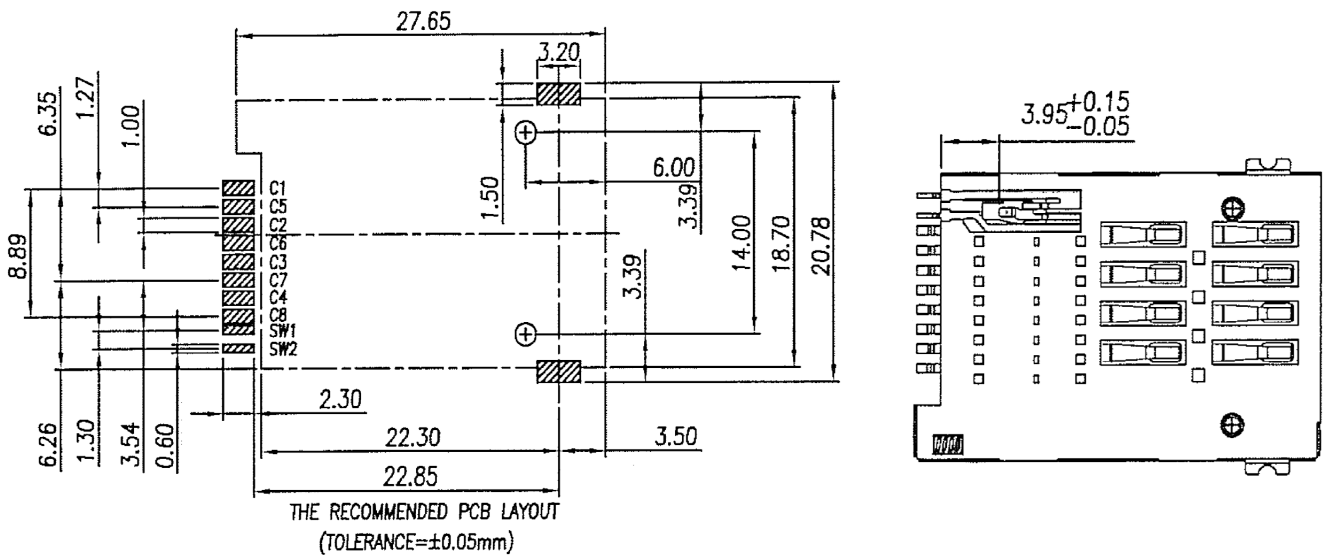

Dimensions : Millimetres

Part Number Table

Description	Part Number
Connector, Micro SIM, 8 Pin, Cover	SIMMP-P0805BTR2-0

Important Notice : This data sheet and its contents (the "Information") belong to the members of the Premier Farnell group of companies (the "Group") or are licensed to it. No licence is granted for the use of it other than for information purposes in connection with the products to which it relates. No licence of any intellectual property rights is granted. The Information is subject to change without notice and replaces all data sheets previously supplied. The Information supplied is believed to be accurate but the Group assumes no responsibility for its accuracy or completeness, any error in or omission from it or for any use made of it. Users of this data sheet should check for themselves the Information and the suitability of the products for their purpose and not make any assumptions based on information included or omitted. Liability for loss or damage resulting from any reliance on the Information or use of it (including liability resulting from negligence or where the Group was aware of the possibility of such loss or damage arising) is excluded. This will not operate to limit or restrict the Group's liability for death or personal injury resulting from its negligence. Multicomp is the registered trademark of the Group. © Premier Farnell plc 2012.

www.element14.com
www.farnell.com
www.newark.com

