



## The plastic circular connector with metal locking

UTG provides the complete answer to the need for economical lightweight  
and robust metal coupling

Flammability rating



UL94-V0 compliant

Rapid and secure locking



Locks with audible positive «click»

Intermateable and interchangeable



With UTO, UTP and UTS series

Complete range of contacts





Trim Trio contacts #16



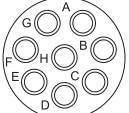
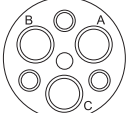
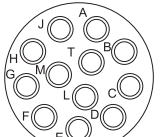
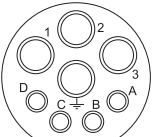
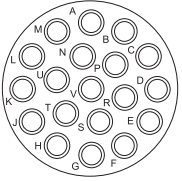
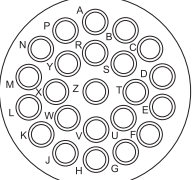
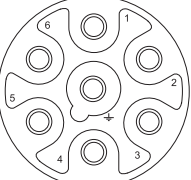
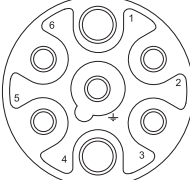

## Layout

Shell size	Contact # 16 (Ø 1,6)	Mixed power / signal versions	
10	 <p>10-4 4 x #16 (Ø 1,6)</p>	 <p>10-3 3 x #16 (Ø 1,6) Group C 250V</p>	 <p>10-3W3 3 x #16 (Ø 1,6) 3 x #20 (Ø 1,0)</p>
12	 <p>12-8 8 x #16 (Ø 1,6)</p>	 <p>122G1 3 x #12 (Ø 2,4)</p>	
14	 <p>14-12 12 x #16 (Ø 1,6)</p>	 <p>14-8 4 x #12 (Ø 2,4) 4 x #16 (Ø 1,6)</p>	
16	 <p>16-19 19 x #16 (Ø 1,6)</p>		
18	 <p>18-23 23 x #16 (Ø 1,6)</p>	 <p>18-7 Group C 380V 7 x #16 (Ø 1,6)</p>	 <p>18-7 34 2 x #12 (Ø 2,4) 5 x #16 (Ø 1,6)</p>

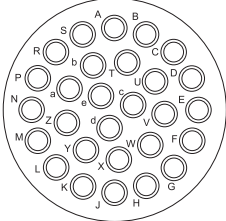
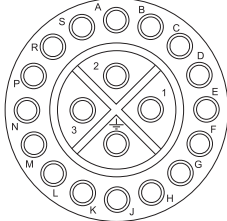
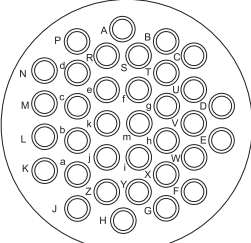
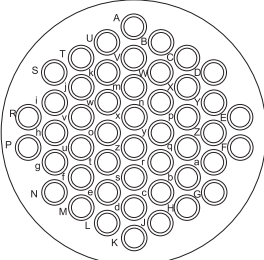
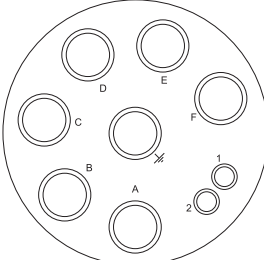
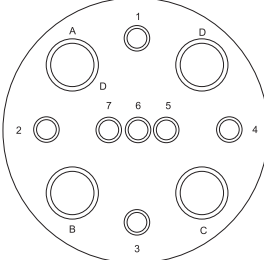

Shell size	Contact # 16 (Ø 1,6)	Mixed power / signal versions
20	 <p data-bbox="520 819 708 875">20-28 28 x #16 (Ø 1,6)</p>	 <p data-bbox="1114 819 1302 902">20-20 20 x #16 (Ø 1,6) Group C 660V</p>
22	 <p data-bbox="520 1216 708 1272">22-35 35 x #16 (Ø 1,6)</p>	
24	 <p data-bbox="520 1606 708 1662">24-48 48 x #16 (Ø 1,6)</p>	 <p data-bbox="1123 1606 1289 1688">24-7 7 x #8 (Ø 3,6) 2 x #16 (Ø 1,6)</p>
		 <p data-bbox="1123 1998 1289 2080">24-11 4 x #8 (Ø 3,6) 7 x #16 (Ø 1,6)</p>

Contact identification positions shown are for mating face of pin contact connectors and wire face of socket contact connectors.



## Specifications

Shell size	Contacts number*	Connector type / Part number			
		Cable plug		Panel mounting receptacle	
		Male insert	Female insert	Male insert	Female insert
10	4 #16	UTG6104PN	UTG6104SN	UTG0104P	UTG0104S
	2 + ground #16	UTG6103PN	UTG6103SN	UTG0103P	UTG0103S
	3 #20 + 3 #16	UTG6103W3PN	-	-	-
12	8 #16	UTG6128PN	UTG6128SN	UTG0128P	UTG0128S
	3 #12	UTG6122G1PN	UTG6122G1SN	UTG0122G1P	UTG0122G1S
14	12 #16	UTG61412PN	UTG61412SN	UTG01412P	UTG01412S
	4#12 + 4 #16	-	UTG6148SN	UTG0148P	-
16	19 #16	UTG61619PN	UTG61619SN	UTG01619P	UTG01619S
18	23 #16	UTG61823PN	UTG61823SN	UTG01823P	UTG01823S
	7 #16	UTG6187PN	UTG6187SN	UTG0187P	UTG0187S
	2 #12 + 5 #16	UTG6187PN34	UTG6187SN34	UTG0187P34	UTG0187S34
20	28 #16	UTG62028PN	UTG62028SN	UTG02028P	UTG02028S
	20 #16	UTG62020PN	UTG62020SN	UTG02020P	UTG02020S
22	35 #16	UTG62235PN	UTG62235SN	UTG02235P	UTG02235S
24	48 #16	UTG62448PN	UTG62448SN	UTG02448P	UTG02448S
	7 #8 + 2 #16	UTG6247PN	UTG6247SN	UTG0247P	UTG0247S
	4 #8 + 7 #16	-	UTG62411SN	UTG02411P	-

\*Contacts supply separately  
 For IP65 waterprotected version (for only receptacle) add «H» behind N or S. Ex. UTG0103PH



## Dimensions

### Cable plug - UTG6

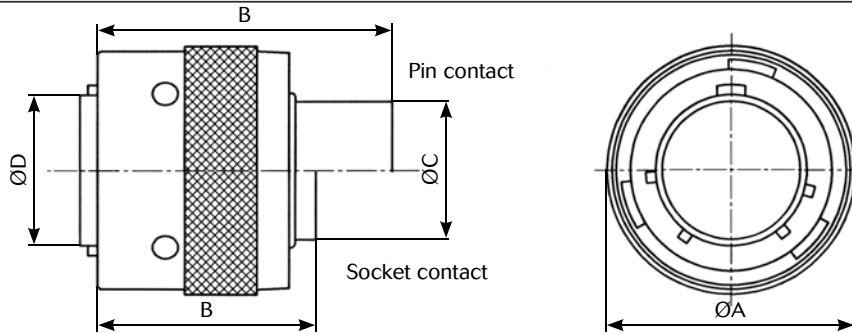

Shell size	ØA <sup>±0.2</sup>	B max		ØC <sup>±0.15</sup>	ØD <sup>±0.15</sup>	ØE <sup>±0.2</sup>
		Pin contact	Socket contact			
10	21.6	31.8	23.9 / 26.75	10.9	12.2	19.1
12	24.8		23.9	13.8	15.1	
14	28.0			17.0	18.3	
16	31.2		19.9	21.5		
18	34.3	31.8 / 33.0	23.9 / 29.0	22.4	24.0	
20	37.5	31.8 / 35.3	24.9	25.6	27.2	
22	47.0	31.8		28.5	30.4	
24	50.1		26.2	31.7	33.5	

### Wall mounting - UTG0

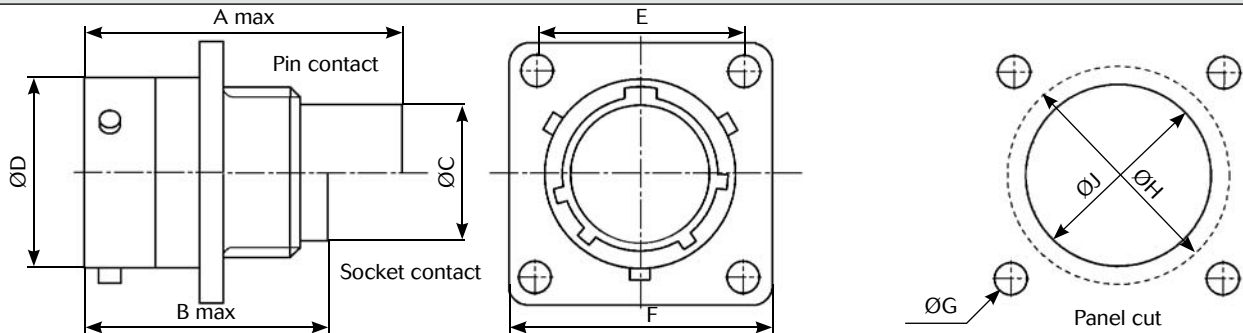

Shell size	A max		B <sup>±0.15</sup>	C <sup>±0.2</sup>	ØD <sup>±0.15</sup>	ØE <sup>±0.2</sup>	F <sup>±0.25</sup>	ØG <sup>±0.1</sup>	ØH <sup>±0.1</sup>	ØJ <sup>±0.1</sup>
	Pin contact	Socket contact								
10	31.7	24.3 / 27.6	2.3	11.3	15.0	18.3	23.8	3.2	17.3	15.1
12		24.3			19.0	20.6	26.2		21.8	18.2
14					22.2	23.0	28.6		25.0	21.4
16		25.3			24.6	31.0	28.1		24.6	
18	31.7 / 34.0	24.3 / 30.4	2.5	11.3 / 17.9	28.5	27.0	33.3	31.3	27.7	
20	33.3	27.0		14.5	31.7	29.4	36.5	34.5	30.9	
22		28.0	34.9		31.8	39.7	37.7	34.1		
24		30.4	3.5		15.3	38.0	34.9	42.9	3.9	40.9

Note: all dimensions are in mm



## Specifications

Shell size	Contacts number*	Connector type / Part number	
		Cable plug	
		Male insert	Female insert
10	4 #16	UTG1104PN	UTG1104SN
	2 + ground #16	UTG1103PN	UTG1103SN
	3 #20 + 3 #16	-	UTG1103W3SN
12	8 #16	UTG1128PN	UTG1128SN
14	12 #16	UTG11412PN	UTG11412SN
16	19 #16	UTG11619PN	UTG11619SN
18	23 #16	UTG11823PN	UTG11823SN
20	28 #16	UTG12028PN	UTG12028SN
	20 #16	UTG12020PN	UTG12020SN
22	35 #16	UTG12235PN	UTG12235SN
24	48 #16	UTG12448PN	UTG12448SN
	7 #8 + 2 #16	UTG1247PN	UTG1247SN

\*Contacts supply separately  
 For IP65 waterprotected version (for only receptacle) add «H» behind N or S. Ex. UTG0103PH



## Dimensions

Free hanging - UTG1				
Shell size	$\text{ØA}^{\pm 0.2}$	B max		$\text{ØD}^{\pm 0.15}$
		Pin contact	Socket contact	
10	19.5	31.7	24.3 / 27.6	15.0
12	23.5		24.3	19.0
14	27			22.2
16	30.0		25.3	
18	33.3	31.7 / 34.0	24.3 / 30.4	28.5
20	36.5	33.3 / 34.3	25.9	31.7
22	39.5	38.0		34.9
24	42.1			38.0



## Accessories

### Cable clamp



Part number	Shell size
UTG10AC	10
UTG12AC	12
UTG14AC	14
UTG16AC	16
UTG18AC	18
UTG20AC	20
UTG22AC	22
UTG24AC	24

### Cable clamp for waterprotected (IP65) application



Part number	Shell size
UTG10PG	10
UTG12PG	12
UTG14PG	14
UTG16PG	16
UTG18PG	18
UTG20PG	20
UTG22PG	22
UTG24PG	24

### Cable gland for waterprotected (IP65) application



Part number	Shell size
UTG10ST	10
UTG12ST	12
UTG14ST	14
UTG16ST	16
UTG18ST	18
UTG20ST	20
UTG22ST	22
UTG24ST	24

### Metal shrink boot



Part number	Shell size
UTG10AD	10
UTG12AD	12
UTG14AD	14
UTG16AD	16
UTG18AD	18
UTG20AD	20
UTG22AD	22
UTG24AD	24

### Dustcap with chain (plug)



Part number	Shell size
UTG610DCG	10
UTG612DCG	12
UTG614DCG	14
UTG616DCG	16
UTG618DCG	18
UTG620DCG	20
UTG622DCG	22
UTG624DCG	24

### Dustcap with chain (receptacle)



Part number	Shell size
UT010DCG	10
UT012DCG	12
UT014DCG	14
UT016DCG	16
UT018DCG	18
UT020DCG	20
UT022DCG	22
UT024DCG	24





## Plastic protective cap for receptacle



Part number	Shell size
8500-5586A	10
8500-5587A	12
8500-5588A	14
8500-5589A	16
8500-5590A	18
8500-5591A	20
8500-5592A	22
8500-5593A	24

## Gasket



Part number	Shell size
UTFD12B	10
UTFD13B	12
UTFD14B	14
UTFD15B	16
UTFD16B	18
UTFD17B	20
UTFD18B	22
UTFD19B	24



## Tooling

### Standard contacts

Contact size	Part number	Head	Handles
#20 1mm	RM/RC 24W3 -	S20RCM	SHANGLES
	RM/RC 20W3 -		
	RM/RC 18W3 -		
	SM 24W3S <sup>(1)</sup> SC 24W3S <sup>(1)</sup>	S20SCM20	
	SM 24WL3S <sup>(2)</sup> SC 24WL3S <sup>(2)</sup>		
	SM/SC 20W3S <sup>(1)</sup> SM/SC 20WL3S <sup>(2)</sup>		
#16 1.6mm	RM/RC 28M1-	S16RCM20	
	RM/RC 24M9-		
	RM/RC 20M13-		
	RM/RC 20M12-		
	RM/RC 16M23-	S16RCM16	
	RM/RC 14M50-	S16RCM1450	
	RM/RC 14M30-	S16RCM14	
	SM/SC 24M1- SM/SC 24ML1-	S16SCM20	
	SM/SC 20M1- SM/SC 20ML1-		
	SM/SC 16M1- SM/SC 16ML1-	S16SCML1	
	SM/SC 14M1- SM/SC 14ML1-		
	SM/SC 16M11- SM/SC 16ML11-		



(1) contact reeled (2) loose contact  
Note: endurance of SHANGLES tool = 5 000 cycles.

Contact size	Part number	Tool with separate locator			Extraction tools
		Hand tool	Positioner + locator setting		
#12 2.4mm	8291 1457N- / 8291 1456-	M317	VGE10077A	1-2	5106020924
	8291 1459N- / 8291 1458-			2	
	8291 1461N- / 8291 1460-			2	
	8291 1463N- / 8291 1462-			3	
	8291 1465N- / 8291 1464-			3	
	8291 1467N- / 8291 1466-			4	
#8 3.6mm	8291 3601A / 8291 3600A	M317	VGE10078A	3	51060210936
	8291 3603A / 8291 3602A			3	
	8291 3605A / 8291 3604A			4	
	8291 3607A / 8291 3606A			5	
	8291 3609A / 8291 3608A			6/7	

### Specific contacts

Contact size	Part number	Hand tools (SHANGLES) head	Tool with separate locator			Extraction tools				
			Hand tool	Positioner + locator setting						
#16 Ø 1.6mm Longer RM contact	RM28M1GE1- RM24M9GE1- RM20M13GE1-	S16RCM20	MH860	MH86186	6/8					
	RM16M23 GE1- RM14M50 GE1- RM14M30 GE1-					M317	UH25	3		
	RC28M1GE7- RC24M9GE7- RC20M13GE7- RC20M12GE7-								MH860	MH86164G
	RC16M23GE7- RC14M50GE7- RC14M30GE7-	M317								
						5/7				
						6/8				
#16 Ø 1.6mm Shorter RC contact	RC28M1GE7- RC24M9GE7- RC20M13GE7- RC20M12GE7-	S16RCM20	MH860	MH86164G	3					
	RC16M23GE7- RC14M50GE7- RC14M30GE7-					M317	UH25	6/8		

### Coaxial contacts

See pages 17



## Crimping

One of the key factors which affects the performance of a connector, is the way contacts are terminated. Crimped connections are nowadays seen as the best solution to ensure quality throughout the lifetime of the product. Here are some reasons why we recommend this method of termination for UTG connectors:

### Advantages (Extract from the IEC 60352-2):

- Efficient processing of connections at each production level
- Processing by fully-automatic or semi-automatic crimping machines, or with hand operated tools
- No cold-soldered joints
- No degradation of the spring characteristic of female contacts by the soldering temperature

- No health risk from heavy metal and flux steam
- Preservation of conductor flexibility behind the crimped connection
- No burnt, discolored and overheated wire insulation
- Good connections with reproducible electrical and mechanical performances
- Easy production control.

To ensure that the crimp tooling is performing according to original specifications, it is important to carry out regular checks. A common way to check the performance of tooling is with a simple pull test, ideally using a dedicated electric pull tester. Minimum recommended full forces are indicated in the tables below:

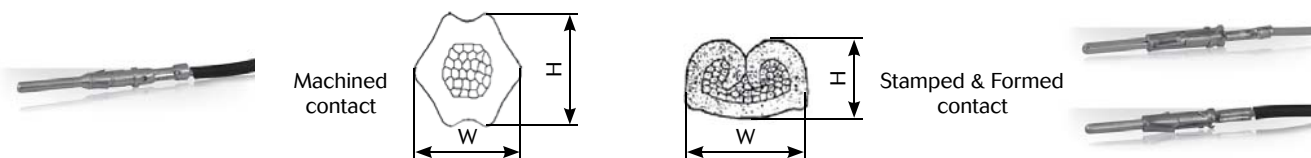

Active contact part	Contact type	Die location on heads	Wire section range	Section (mm <sup>2</sup> )	Tensile straight test (mini)	Height (Mm) H (±0.075)	Width (Mm) W (±0.075)	Head's P/N	
Machined contacts size 20	RM/RC 24W3*	26/24	AWG 26	0.12 min	15 N	0.95	1.27	S20RCM	
			AWG 24	0.25 max	32 N				
	RM/RC 20W3*	22/20	AWG 22	0.32 min	40 N	1.26	1.78		
AWG 20			0.50 max	60 N					
RM/RC 18W3*	20/18	AWG 20	0.50 max	60 N	1.35	1.86			
		AWG 18	0.82 max	90 N					
S & F contacts size 20	SM/SC 24WL3TK6*	26/24	AWG 26	0.12 min	15 N	0.80	1.49	S20SCM20	
			AWG 24	0.25 max	32 N				
	SM/SC 20WL3TK6*	22/20	AWG 22	0.32 min	40 N	1.01	1.53		
AWG 20			0.50 max	60 N					
Machined contacts size 16	RM/RC 28M1K*	30/28	AWG 30	0.05 min	11 N	1.14	1.41		S16RCM20
			AWG 28	0.08 max	11 N				
	RM/RC 24M9K*	26/24	AWG 26	0.12 min	15 N	1.15	1.41		
			AWG 24	0.25 max	32 N				
	RM/RC 20M13K*	22/20	AWG 22	0.32 min	40 N	1.26	1.76		
			AWG 20	0.50 max	60 N				
			AWG 22	0.32 min	40 N				
	RM/RC 20M12K*	20	AWG 20	0.50 max	60 N	1.66	2.18		
			18	AWG 18	0.82 max			90 N	S16RCM16
	RM/RC 16M23K*	16	AWG 16	1.50 max	150 N	1.96	2.43		
16			AWG 16	1.50 min	150 N	2.10	2.68		
RM/RC 14M30K*	14	AWG 14	2.50 min	230 N	2.30	2.78	S16RCM14		
		16	AWG 16	1.50 min	150 N	2.09		2.59	
RM/RC 14M50K*	14	AWG 14	2.50 max	230 N	2.26	2.71	S16RCM1450		
		16	AWG 16	1.50 min	150 N	2.09		2.59	
S & F contacts size 16	SM/SC 24ML1TK6*	26/24	AWG 26	0.12 min	15 N	0.84	1.50	S16SCM20	
			AWG 24	0.25 max	32 N				
	SM/SC 20ML1TK6*	22/20	AWG 22	0.32 min	40 N	1.02	1.54		
			AWG 20	0.50 max	60 N				
	SM/SC 16ML11TK6*	18	AWG 18	0.82 min	90 N	1.32	2.09	S16SCML11	
			AWG 16	1.50 max	150 N	1.36	2.10		
	SM/SC 16ML1TK6*	16	AWG 16	0.82 min	90 N	1.49	2.02	S16SCML1	
AWG 16			1.50 max	150 N	1.7	2.05			
SM/SC14ML1TK6*	14	AWG 14	2.50 max	230 N	1.79	2.58			

(1): example of plating, for other plating see page 13



## Contacts



### Description

The UTG series is delivered without contact (crimp version). When contacts are not loaded, this series offers the unique possibility to use the same contact in any layout as long as it receives the same active part size. Thus it is possible to buy only one contact reference and equip all connectors even if housings are different.

The main benefit is the standardisation which means reduction of inventory cost.

Bearing in mind that any additional tool or complicated assembly process should be avoided, our contacts are based on a snap-in principle which avoid the use of an insertion tool.

Crimp contacts are available in different versions:



• machined



• stamped & formed



• coaxial



• fiber optic



## Contact plating selector guide

As soon as you know what contact size you need, you next have to decide on which type to use.

Souriau proposes mainly two different types of electrical contacts:

- Machined
- Stamped & formed

Machined contacts are generally chosen for low quantities purpose as well as a better solution for power applications.

Stamped & formed contacts offer the ability to be crimped automatically which makes them more suitable for high volume production applications.

Then comes the question: What plating should I choose ?

Hereunder is a graph with criteria to guide you:

*NB: do not mix different plating (e.g. tin plated pin contact with gold plated socket contact).*

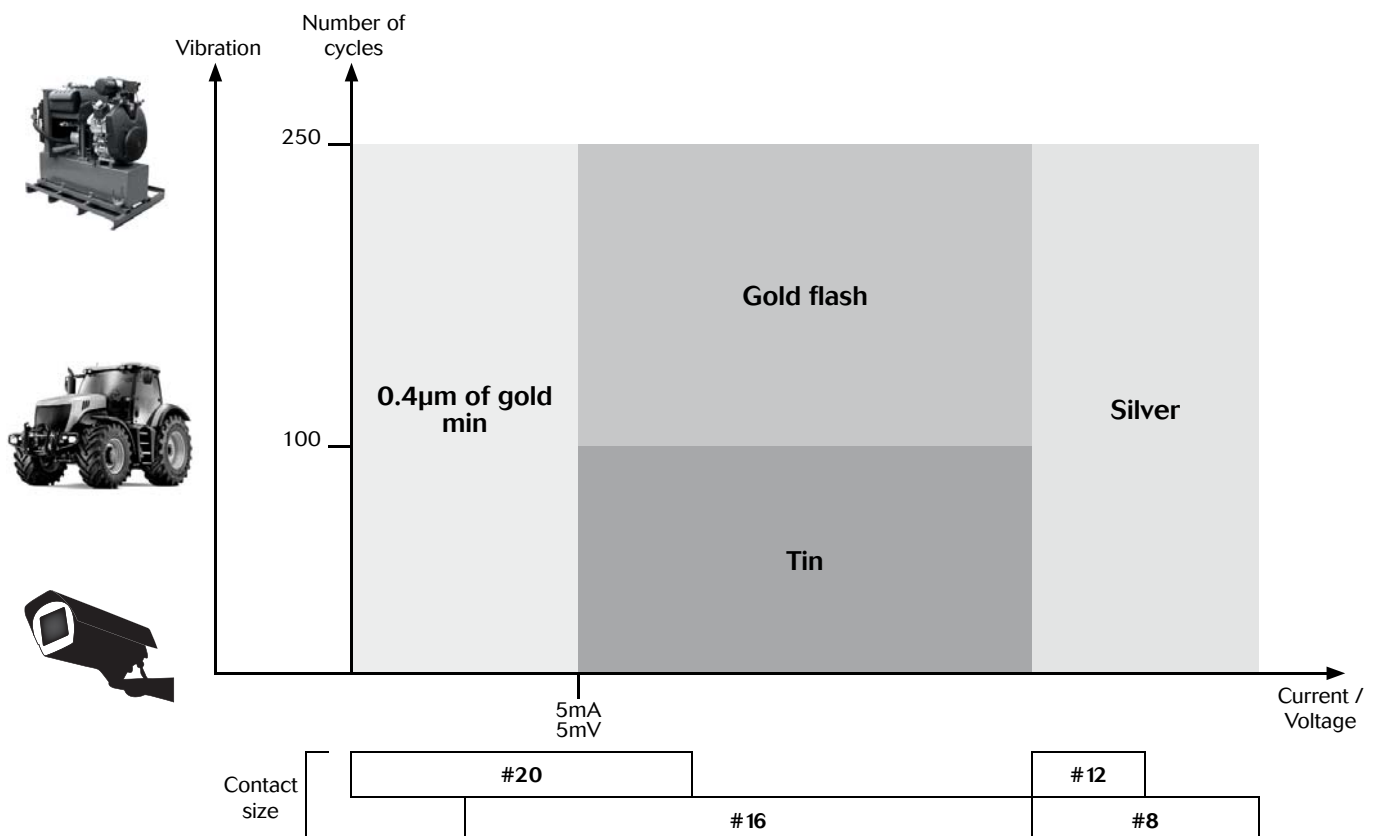



## Contact selector guide

### Contact preloaded

Electrical characteristics: contact resistance		
#20 Ø1mm	Machined	< 4mΩ
#16 Ø1.6mm	Machined	< 3mΩ

Available platings (contact preloaded)	
Min 0.4μ gold over 2μ Ni	

### Contact supply separately

Electrical characteristics: contact resistance		
#20 Ø1mm	Machined	< 6mΩ
	Stamped & formed	< 15mΩ
#16 Ø1.6mm	Machined	< 3mΩ
	Stamped & formed	< 6mΩ
#12 Ø2.4mm	Machined	< 5mΩ
#8 Ø3.6mm	Machined	< 5mΩ

Available platings (contact supply separately)	
A	2μ Ni + 2μ Ag
J	Gold flash over 2μ Ni
K	Min 0.4μ gold over 2μ Ni
S31	Active part: Gold flash over Ni Crimp area: Nickel
S18	Active part: 0.75μ gold min over 2μ Ni Crimp area: 1.3μ tin over Ni Other: Nickel
S25 S26	Active part: 0.75μ Au over Ni Crimp area: flash Au over Ni
TK6	2-5μ Sn pre-plated

## Packaging

Conscious of the wide variety of applications, contact packaging has been considered for small series (bulk packaging) and high volume production (reeled contacts):

### Size contacts #20 & #16



- 25 pieces bulk packing (stamped & formed contacts)



- 50 pieces bulk packing (machined contacts)



- 1000 pieces bulk packing (machined contacts)



- 3000 pieces reeled (stamped & formed contacts)



- 5000 pieces reeled (machined contacts)

### Size contacts #12 & #8



- 100 pieces bulk packing (stamped & formed contacts)



## Crimp contacts

### Standard version



Contact size	Type	Wire size		Part number		Max wire Ø	Max insulator Ø	Plating available
		AWG	mm <sup>2</sup>	Male	Female			
#20 Ø1 mm	Machined	26-24	0.13-0.20	RM24W3K	RC24W3K		1.58 max	K
	Stamped & Formed	26-24	0.13-0.25	SM24W3 - (1)	SC24W3 - (1)		0.89-1.58	TK6 S25 (female) S26 (male)
				SM24WL3 - (2)	SC24WL3 - (2)			
	Machined	22-20	0.32-0.52	RM20W3K	RC20W3K		1.58 max	K
	Stamped & Formed	22-20	0.35-0.5	SM20W3 - (1)	SC20W3 - (1)		1.17-2.08	TK6 S25 (female) S26 (male)
SM20WL3 - (2)				SC20WL3 - (2)				
Machined	20-18	0.50-0.93	RM18W3K	RC18W3K		2.10 max	K	
#16 Ø1.6 mm	Machined	30-28	0.05-0.08	RM28M1-	RC28M1-	0.55	1.1	K, J
	Machined	26-24	0.13-0.2	RM24M9-	RC24M9-	0.8	1.6	K, J
	Stamped & Formed	26-24	0.13-0.25	SM24M1 - (1)	SC24M1 - (1)	0.89-1.28	Insulation grip	S31, S18, TK6
				SM24ML1 - (2)	SC24ML1 - (2)			
	Machined	22-20	0.32-0.52	RM20M13-	RC20M13-	1.18	1.8	K, J
				RM20M12-	RC20M12-		2.2	
	Stamped & Formed	22-20	0.35-0.5	SM20M1 - (1)	SC20M1 - (1)	1.17-2.08	Insulation grip	S31, S18, TK6
				SM20ML1 - (2)	SC20ML1 - (2)			
	Machined	20-16	0.52-1.5	RM16M23-	RC16M23-	1.8	3.2	K, J
	Stamped & Formed	18-16	0.8-1.5	SM16M1 - (1)	SC16M1 - (1)	3.0	No insulation grip	S31, S18, TK6
				SM16ML1 - (2)	SC16ML1 - (2)			
Stamped & Formed	18-16	0.8-1.5	SM16M11 - (1)	SC16M11 - (1)	2.0-3.0	Insulation grip	S31, S18, TK6	
			SM16ML11 - (2)	SC16ML11 - (2)				
Machined	16-14	1.5-2.5	RM14M50-	RC14M50-	2.05	3.2	K, J	
Machined	16-14	1.5-2.5	RM14M30-	RC14M30-	2.28	3.2	K, J	
Stamped & Formed	14	2.0-2.5	SM14M1 - (1)	SC14M1 - (1)	3.2	No insulation grip	S31, S18, TK6	
			SM14ML1 - (2)	SC14ML1 - (2)				
#12 Ø2.4 mm	Machined	22	0.13-0.4	82911457NA	82911456A	-	4.9	A, K
		20	0.5	82911459NA	82911458A			
		18	0.75-1.0	82911461NA	82911460A			
		16	1.5	82911463NA	82911462A			
		14	2.5	82911465NA	82911464A			
		12	4	82911467NA	82911466A			
#8 Ø3.6 mm	Machined	16	1.5	82913601A	82913600A	-	6.5	A
		14	2.5	82913603A	82913602A			
		12	4	82913605A	82913604A			
		10	6.0	82913607A	82913606A			
		8	10.0	82913609A	82913608A			

(1) contact reeled (2) loose contact

Example: RM24W3K - Size #20, Machined, AWG24 wire.



## Crimp contacts

### First Mate Last Break contacts

Contact size	Type	Wire size		Part number		Max wire Ø	Max insulator Ø	Color band		Plating available
		AWG	mm <sup>2</sup>	Male	Female			Front	Rear	
# 16 Ø1.6 mm Longer male contact (+1mm)	Machined	30-28	0.05-0.08	RM28M1GE1□	-	0.55	1.1	-	Red	□ = K or J
		26-24	0.13-0.2	RM24M9GE1□		0.8	1.6	Red	Red	
		22-20	0.32-0.52	RM20M13GE1□		1.18	1.8	Black	Red	
				RM20M12GE1□			2.2	Blue	Red	
		20-16	0.52-1.5	RM16M23GE1□		1.8	3.2	-	Red	
		16-14	1.5-2.5	RM14M50GE1□		2.05	-	-	Red	
16-14	1.5-2.5	RM14M30GE1□	2.28	-	-	Red				
# 16 Ø1.6 mm Shorter female contact (-0.7mm)	Machined	30-28	0.05-0.08	-	RC28M1GE7□	0.55	1.1	-	Blue	□ = K or J
		26-24	0.13-0.2		RC24M9GE7□	0.8	1.6	Red	Blue	
		22-20	0.32-0.52		RC20M13GE7□	1.18	1.8	Black	Blue	
					RC20M12GE7□		2.2	Blue	Blue	
		20-16	0.52-1.5		RC16M23GE7□	1.8	3.2	-	Blue	
		16-14	1.5-2.5		RC14M50GE7□	2.05	-	-	Blue	
16-14	1.5-2.5	RC14M30GE7□	2.28	-	-	Blue				

Example: RM16M3GE1K - Size # 16, Machined, Longer male, AWG16 wire.

### How to make FMLB / LMFB connection

Contact 1 \ Contact 2	Standard male contact	Standard female contact	Longer male contact
Standard male contact		✓	
Standard female contact	✓		✓ FMLB
Shorter female contact	✓ LMFB		

First Mate Last Break contacts should be chosen only if the cavity is not marked with the earth symbol. For cavities marked with the earth symbol, standard contacts will fulfill the same role as a first mate, last break contact used in a standard cavity.



Ground symbol





## #16 coaxial contacts

### Coaxial contact range

We provide 2 types of coaxial contacts suitable for 50 or 75Ω, coaxial cable or twisted pair cable.

#### Monocrimp coaxial contact

- The monocrimp one-piece coaxial contacts offer high reliability plus the economic advantage of a 95% reduction in installation time over conventional assembly methods.
- This economy is achieved by simultaneously crimping both the inner conductor and outer braid or drain wire.



#### Multipiece crimp coaxial contact

- The inner conductor and outer braid is crimped individually.
- The thermoplastic insulating bushing in the outer body is designed to accept and permanently retain the inner contact.
- An outer ferrule is used to connect the braid to the outer contact and provide cable support to ensure against bending and vibration.



#### Suitable for Coaxial cable or Twisted cable

- For jacket diameter from 1.78 to 3.05mm  
Inner conductor up to 2.44mm diameter



- For jacket diameter from 0.64 to 1.45mm  
Inner conductor from AWG30 to AWG24

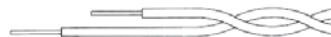

#### Contacts for coaxial cable summary

Contact type	Contact range		Contact part number with cable combination	Cabling notice
	Male contact	Female contact		
Multipiece	RMDXK10D28	RCDXK1D28	See page 21	See pages 25 & 26
Monocrimp	RMDX60xxD28	RCDX60xxD28		See page 27

#### Contacts for twisted pairs cable summary

Contact type	Contact range		Contact part number with cable combination	Cabling notice
	Male contact	Female contact		
Multipiece	RMDXK10D28 + YORK090	RCDXK1D28 + YORK090	See page 22	See page 23
Monocrimp	RMDX60xxD28	RCDX60xxD28		See page 24



## PCB contacts

### PCB contacts

#### PCB soldering

UTG range can be carried out with a wave soldering process, but not reflow soldering process.  
All high temperature processes are prohibited.



Contact size	Type	Part number		Plating
		Male	Female	
#20 Ø1mm	Short version	RMW50A7K	RCW50A7K	K
	Long version	RMW5016K	RCW5016K	
#16 Ø1.6mm	Short version	RM20M12E8K	RC20M12E8K	K
	Long version	RM20M12E83K	RC20M12E83K	
			RC20M12E84K	

Exemple: RM50A7K - Size #20, Short version, male.

#### Nominal length (G)

Dimension of dipsolder contacts out of connector (contacts to be ordered separately).

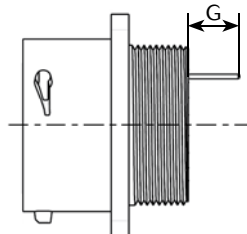

#### UTGØ

Connector size	Pin contact		Socket contact		
	RM20M12E8*	RM20M12E83*	RC20M12E8*	RC20M12E83*□	RC20M12E84*
10	4	9.1	3.3	8.5	12.1
12	4	9.1	3.3	8.5	12.1
14	4	9.1	3.3	8.5	12.1
16	4	9.1	3.3	8.5	12.1

\* Plating indication: see plating table



## Fibre optic contacts

### Description

#### Size 16 Fibre optic contacts for TRIM TRIO® connectors

Size 16 Fibre optic contacts are optical contacts designed for the integration of optical links in all TRIM TRIO® cable connectors.

The Fibre optic contacts are designed to accommodate:

- Plastic Optical Fibre (POF)
  - 1 mm core and 2.2 mm jacket
- Plastic Clad Fibre (PCF)
  - 230µm core and 2.2 mm jacket

Typical features and benefits are:

- Socket contact is spring loaded to avoid any air gap between the two optical faces.
- Low insertion loss is provided by high precision pieces.
- Single jumpers, multiway harness and active device housings can be supplied regarding customer requirement.



### Technical characteristics

#### Performance

- Fibre type: .....POF
- Wave length:.....650 nm
- Optical insertion loss (typ.): .....2 dB max.
- Jacketed external diameter:.....2.2mm
- Temperature range:.....-25°C to +70°C
- Cable retention:.....49N
- Mating cycles without cleaning:.....50
- Max. mating cycles:.....500

#### Construction

- Contact body: Copper alloy

#### Connector accommodation

Any TRIM TRIO® size 16 contact can be used in any contact position in any connector in the TRIM TRIO® size 16 interconnection system : UTP, UTS, UTG, UTO.



## Fibre optic contacts

Ordering information	
POF Contacts (Plastic Optical Fibre)	
Male contact.....	Female contact.....
RMPOF1000	RCPOF1000B

POF Contact (Plastic Optical Fibre)																																					
<p><b>STANDARD TOOLING KIT - P/N 80MS0004</b>                      The <i>standard tooling kit</i> is made of the part numbers below that can be ordered separately as well.</p> <table border="1"> <thead> <tr> <th>Part numbers</th> <th>Descriptions</th> </tr> </thead> <tbody> <tr> <td>80WD0005</td> <td>Stripping tool</td> </tr> <tr> <td>80WD0025</td> <td>Automatic stripping tool for Ø 0.5 mm, 0.6 mm, 0.7 mm &amp; 3.8 mm</td> </tr> <tr> <td>80WM0006</td> <td>Ruler</td> </tr> <tr> <td>80WP0005</td> <td>Polishing plate</td> </tr> <tr> <td>80WP0013</td> <td>Non slip base (to hold the polishing plate)</td> </tr> <tr> <td>80WP0014</td> <td>Polishing disk (grain size 9µm)</td> </tr> <tr> <td>80WP0018</td> <td>Polishing tool</td> </tr> <tr> <td>80WP0019</td> <td>Polishing disk (grain size 30µm)</td> </tr> <tr> <td>80WS0002</td> <td>Crimping plier</td> </tr> </tbody> </table>	Part numbers	Descriptions	80WD0005	Stripping tool	80WD0025	Automatic stripping tool for Ø 0.5 mm, 0.6 mm, 0.7 mm & 3.8 mm	80WM0006	Ruler	80WP0005	Polishing plate	80WP0013	Non slip base (to hold the polishing plate)	80WP0014	Polishing disk (grain size 9µm)	80WP0018	Polishing tool	80WP0019	Polishing disk (grain size 30µm)	80WS0002	Crimping plier	<p><b>SPECIFIC TOOLING LIST - can be ordered only separately</b></p> <table border="1"> <thead> <tr> <th>Part numbers</th> <th>Descriptions</th> </tr> </thead> <tbody> <tr> <td>80WG0010</td> <td>Needle</td> </tr> <tr> <td>80WG0015</td> <td>Capsule</td> </tr> <tr> <td>80WG0016</td> <td>Syringe</td> </tr> <tr> <td>80WN0005</td> <td>Dry air spray</td> </tr> <tr> <td>80WN0006</td> <td>Optical paper</td> </tr> <tr> <td>80WN0012</td> <td>Dropping bottle</td> </tr> <tr> <td>80WN0008</td> <td>Wiping solvent</td> </tr> </tbody> </table>	Part numbers	Descriptions	80WG0010	Needle	80WG0015	Capsule	80WG0016	Syringe	80WN0005	Dry air spray	80WN0006	Optical paper	80WN0012	Dropping bottle	80WN0008	Wiping solvent
Part numbers	Descriptions																																				
80WD0005	Stripping tool																																				
80WD0025	Automatic stripping tool for Ø 0.5 mm, 0.6 mm, 0.7 mm & 3.8 mm																																				
80WM0006	Ruler																																				
80WP0005	Polishing plate																																				
80WP0013	Non slip base (to hold the polishing plate)																																				
80WP0014	Polishing disk (grain size 9µm)																																				
80WP0018	Polishing tool																																				
80WP0019	Polishing disk (grain size 30µm)																																				
80WS0002	Crimping plier																																				
Part numbers	Descriptions																																				
80WG0010	Needle																																				
80WG0015	Capsule																																				
80WG0016	Syringe																																				
80WN0005	Dry air spray																																				
80WN0006	Optical paper																																				
80WN0012	Dropping bottle																																				
80WN0008	Wiping solvent																																				



## #16 coaxial contacts

### Coaxial cable - Contact monocrimp and multipiece

Cable type	Impe- dance	Contact type	Ø over jacket		Ø over dielectric		Inner cond size  Ext. Ø mm	Ø outer braid		Male contact kit for coaxial cable	Female contact kit for coaxial cable
			inch	mm	inch	mm		inch	mm		
RG161/U	75	Multi piece	0.09	2.29	0.057	1.45				RMDXK1ØD28	RCDXK1D28
RG179A/U	75		0.105	2.67	0.063	1.6	0.3	0.084	2.13 max		
RG179B/U	75		0.105	2.67	0.063	1.6	0.3	0.084	2.13 max		
RG187/U	75		0.11	2.79 max	0.06	1.52	0.3				
RG188/U	50		0.11	2.79 max	0.06	1.52	0.51	0.078	1.98 max		
RG174/U	50		0.11	2.92	0.06	1.52	0.48	0.088	2.24 max		
AMPHENOL 21-598	50		0.105	2.67	0.06	1.52	0.48				
RG196/U	50		0.08	2.03 max	0.034	0.086	0.3				
RG178A/U	50		0.075	1.91	0.034	0.86	0.3	0.054	1.37 max		
RG188A/U	50	Mono crimp	0.110	2.79	0.06	1.52	0.51	0.078	1.98 max	RMDX6Ø36D28	RCDX6Ø36D28
KX21TVT (europe) RG178 B/U	50		0.075	1.91	0.034	0.86	0.3	0.054	1.37 max	RMDX6Ø34D28	RCDX6Ø34D28
RG178 / BU	50		0.075	1.91	0.034	0.86	0.3	0.054	1.37 max	RMDX6Ø50D28	RCDX6Ø16D28
RG174/U	50		0.115	2.92	0.06	1.52	0.48	0.088	2.24 max	RMDX6Ø32D28	RCDX6Ø32D28
RG188A/U	50		0.11	2.79	0.06	1.52	0.51	0.078	1.98 max	RMDX6Ø36D28	RCDX6Ø36D28
RG316/U	50		0.107	2.72	0.6	1.52	0.51	0.078	2.05 max	RMDX6Ø36D28	RCDX6Ø36D28
raychem 5024A3111	50		0.12	3.05	0.083	2.11	0.64	0.097	2.46	RMDX6Ø52D28	RCDX6Ø52D28
raychem 5026e1614	50		0.083	2.11	0.05	1.27	0.48	0.067	1.7	RMDX6Ø36D28	RCDX6Ø36D28
surprenant pn 8134	-		Multi piece	0.1	2.54	0.058	1.47	0.3			RMDXK1ØD28
PRD PN 247AS- C123-001	-	Mono crimp	0.103	2.62	0.06	1.52	0.51	0.078	1.98	RMDX6Ø18D28	RCDX6Ø18D28
PRD PN 247AS-C1251	-		0.092	2.34	0.05	1.27	0.64	0.067	1.7	RMDX6Ø18D28	RCDX6Ø18D28
JUDD C15013010902	-		0.087	2.13	0.05	1.27	0.48	0.066	1.67	RMDX6Ø36D28	RCDX6Ø36D28
CDC PIN22939200	-		0.09	2.29	0.048	1.22	0.3	0.064	1.63	RMDX6Ø46D28	RCDX6Ø16D28
CDC PIN22939200	-		0.09	2.29	0.048	1.22	0.3	0.064	1.63	RMDX6Ø50D28	RCDX6Ø16D28
CDC PIN245670000	-		0.104	2.64	0.067	1.7	0.3	0.083	2.11	RMDX6Ø50D28	RCDX6Ø16D28
ampex	-		0.114	2.9	0.075	1.91	0.38	0.09	1.29	RMDX6Ø32D28	RCDX6Ø32D28
TI PN 920580	-		0.7	1.78	0.038	0.96	0.48	0.054	1.37	RMDX6Ø24D28	RCDX6Ø24D28
Honeywell PN 58000062	-		0.12	3.05	0.077	1.96	0.41 solid	0.096	2.44	RMDX6Ø26D28	RCDX6Ø26D28
-	-		0.104	2.64	0.067	1.7	0.3		2.11	RMDX6Ø50D28	-
-	-		0.09	2.29	0.048	1.22	0.3		1.63	RMDX6Ø50D28	-
-	-		0.114	2.9	0.075	1.91	0.38		1.29	RMDX6Ø32D28	RCDX6Ø32D28
-	-		0.07	1.78	0.038	0.96	0.48		1.37	RMDX6Ø24D28	RCDX6Ø24D28
-	-		0.12	3.05	0.077	1.96	0.41		2.44	RMDX6Ø26D28	RCDX6Ø26D28



## #16 coaxial contacts

### Twisted cable - Contact monocrimp and multipiece

Cable type	Contact type	Inner AWG cond	Ø over jacket (single wire)		Inner cond size		Ø outer braid		Male contact kit for coaxial cable	Female contact kit for coaxial cable
			inch	mm	Stranded definition	Ext. Ø mm	inch	mm		
2#24 stranded mil w 16878 type B	Multi piece	24	0.049	1.24 max	7/.008		-	-	RMDXK1ØD28	RCDXK1D28
2 #24 solid mil-w-76 type LW		24	0.047	1.12 max	1/.0201		-	-	RMDXK1ØD28	RCDXK1D28
2 #26 stranded mil w 76 type LW or mil w16878 type b&e		26	0.043	1.09 max	7/.0063	0.16	-	-	RMDXK1ØD28	RCDXK1D28
2 #28 solid mil-w-81822/3		28	0.028	0.71 max			-	-	RMDXK1ØD28	RCDXK1D28
TWISTED PAIR 1/.201 SOLID MIL w 76 TYPE lw or MIL W 16878		26	0.044	1.12 max	1/.0201	0.511	-	-	RMDXK1ØD28	RCDXK1D28
twisted pair solid mil w 81822/3		28	0.028	0.71 max	1/.0126	0.32	-	-	RMDXK1ØD28	RCDXK1D28
#28 7/.0036 per Hitachi spec ec-711 (13-2820)	Mono crimp	-	0.046	1.17	7/.0036	-	-	-	RMDX6Ø31D28 + YØRXØ9Ø	RCDX6Ø31D28 + YØRXØ9Ø
20218201		-	0.028	0.71	-	-	-	-	RMDX6Ø31D28 + YØRXØ9Ø	RCDX6Ø31D28 + YØRXØ9Ø
#30 solid		-	0.025	0.64	-	-	-	-	RMDX6Ø15D28 + YØRXØ9Ø	RCDX6Ø15D28 + YØRXØ9Ø
#26 7/.0063		26	0.028	0.71	7/.063	0.16	-	-	RMDX6Ø31D28 + YØRXØ9Ø	RCDX6Ø31D28 + YØRXØ9Ø
#26 19/.004		26	0.049	1.24	19/.004	-	-	-	RMDX6Ø19D28 + YØRXØ9Ø	RCDX6Ø19D28 + YØRXØ9Ø
#24 7/.008		24	0.049	1.24	7/.008	-	-	-	RMDX6Ø19D28 + YØRXØ9Ø	RCDX6Ø19D28 + YØRXØ9Ø
#24 19/.005		24	0.057	1.45	19/.005	-	-	-	RMDX6Ø19D28 + YØRXØ9Ø	RCDX6Ø19D28 + YØRXØ9Ø
-		26	-	1.25	-	-	-	19x0.1	RMDX6Ø19D28 + YØRXØ9Ø	RCDX6Ø19D28 + YØRXØ9Ø
-		24	-	1.25	-	-	-	7x0.2	RMDX6Ø19D28 + YØRXØ9Ø	RCDX6Ø19D28 + YØRXØ9Ø
-		24	-	1.45	-	-	-	19x0.13	RMDX6Ø19D28 + YØRXØ9Ø	RCDX6Ø19D28 + YØRXØ9Ø
-		26	-	0.7	-	-	-	7x0.16	RMDX6Ø31D28 + YØRXØ9Ø	RCDX6Ø31D28 + YØRXØ9Ø



## Twisted pair cable multipiece contact cabling

Cable reference	Contact type	Male contact	Female contact	Crimp tool	Die set	Stop bushing	Cable strip length			Inner conductor crimp		Braid crimp	
							A	B	C	g dim	t dim	g dim	t dim
2#24 stranded mil w 16878 type B	Multi piece	RMDXK10D28	RCDXK1D28	M10S1J	-	-				See assembly notice			
2 #24 solid mil-w-76 type LW													
2 #26 stranded mil w 76 type LW or mil w16878 type B & E													
2 #28 solid mil-w-81822/3													
twisted pair 1/.201 solid mil w 76 type LW or mil w 16878													
twisted pair solid mil w 81822/3													

### Female contact

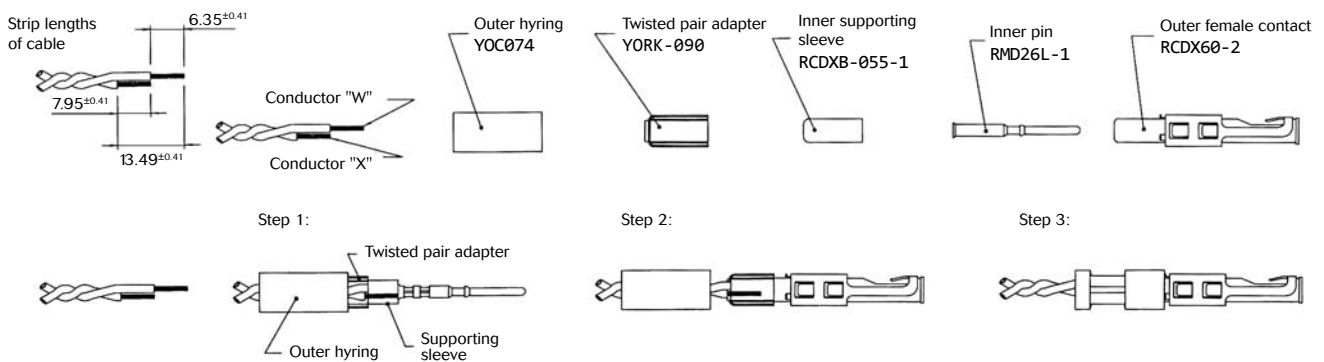

### Male contact

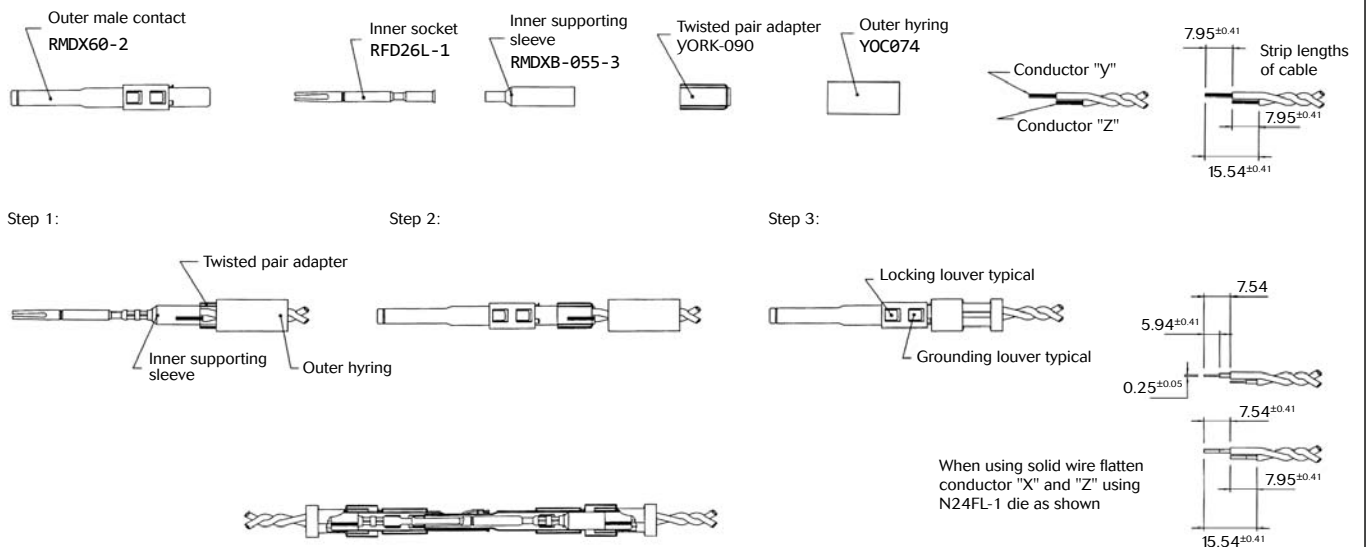

Note : all dimensions are in mm



## #16 coaxial contacts

### Twisted pair cable monocrimp contact cabling

Cable reference	Contact type	Male contact	Female contact	Crimp tool	Die set	Stop bushing	Cable strip length			Inner conductor crimp		Braid crimp	
							A	B	C	g dim	t dim	g dim	t dim
#28 77.0036 per Hitachi spec ec-711 (13-2820)	Mono crimp	RMDX6031D28 + YORX090	RCDX6031D28 + YORX090	M10S1J	S80	SL105	4.7	6.1	4.32	1.30 to 1.12	1.4 to 1.22	2.97 to 2.84	3.07 to 2.9
20218204					S80	SL105	3.94	6.1	3.16	1.30 to 1.17	1.4 to 1.22	2.97 to 2.84	3.07 to 2.79
#30 solid					S83	SL105	4.7	6.1	4.06	1.22 to 1.12	1.35 to 1.22	2.97 to 2.84	3.12 to 2.95
#26 77.0063					S80	SL105	4.7	6.1	4.06	1.30 to 1.17	1.4 to 1.22	2.97 to 2.84	3.07 to 2.9
#26 197.004					M10SG8 ASSY'Y TOOL DIE SET STOP BUSHING M10S1J TOOL	4.7	6.1	4.06	1.22 to 1.17	1.35 to 1.22	2.84 to 2.79	3.12 to 2.97	
#24 77.008						4.7	6.1	4.06	1.22 to 1.17	1.35 to 1.22	2.84 to 2.79	3.12 to 2.97	
#24 197.005						4.7	6.1	4.06	1.22 to 1.17	1.35 to 1.22	2.84 to 2.79	3.12 to 2.97	
AWG26 (19x0.1)					M10SG8 crimping kit	4.7	6	4	/		/		
AWG24 (7x0.2)													
AWG24 (19x0.13)													
AWG26 (7x0.16)													
					S80	SL150							

- Select appropriate monocrimp coax twisted pair contact and cable combination.
- Select appropriate crimp tooling (hand tool, S-die set, stop bushing).
- Strip the twisted pair cable to the designated wire strip lengths.
- Insert the stripped cable into the contact. One cable is to be inserted into the inside diameter of hying, and pushed forward into the inner contact. The second cable is to be inserted between the outside diameter of hying and the inside diameter of the outer contact body.
- Crimp the contact.

Cable strip length

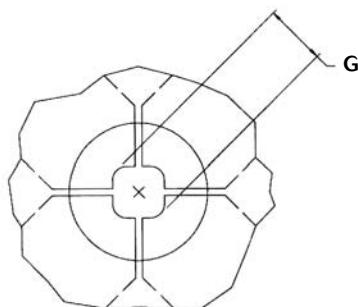
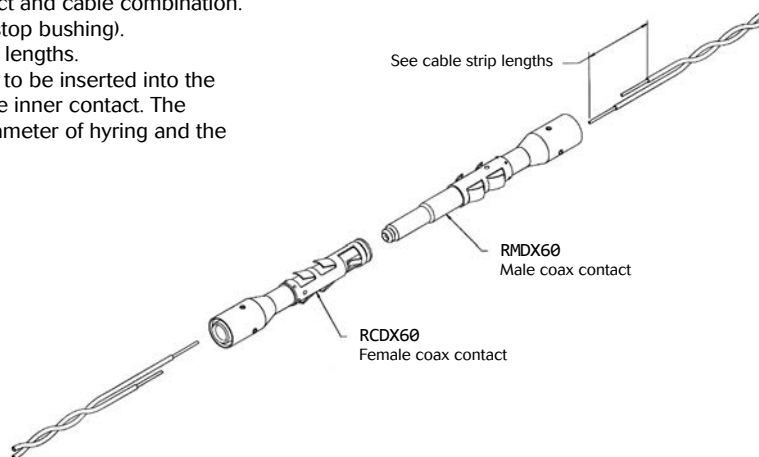
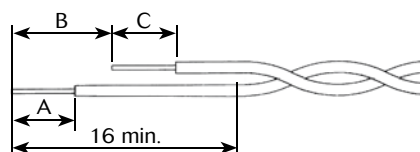

Braid crimp (G) to be measured with die set fully closed

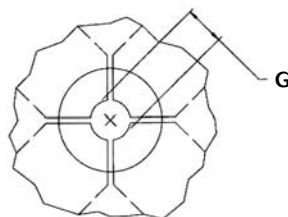

Inner conductor crimp (G) to be measured with die set fully closed

Note : all dimensions are in mm





## Multipiece male contact with coax cable

Cable reference	Contact	Hyring complementary components	Outer contact crimp tool		Inner contact crimp tool		Cable strip length		
			Crimp tool M10S1J		Crimp tool M10S1J		A	B	C
			Die set	Stop bushing	Die set	Stop bushing			
RG161U	Male: RMDXK10D28	YOC074	S221	SL471	S23D2	SL46D2	4.37	7.95	15.88
RG179							4.37	7.95	15.88
RG187U							4.37	7.95	15.88
RG188/U		YOC074 + RMDXB0553			S26D2		4.37	7.95	15.88
RG174/U					S23D2		4.37	7.95	15.88
RG178A/U					-		7.54	9.12	17.53
RG196U		YOC074			S23D2		7.54	9.12	17.53
AMPHENOL 21-598					-		4.37	7.95	15.88
surprenant pn 8134					-		4.37	7.95	15.88

### Multipiece kit details

RMDXK10D28 includes	RMDX602D28	Outer contact
	RFD26L1D28	Inner contact
	YOC074	Outer hyring
	RMDXB0553	Inner supporting sleeve

### Cable strip length

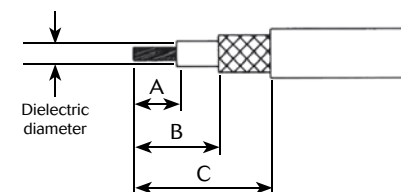

### Contact assembly with dielectric diameter over 1.4mm - without inner supporting sleeve

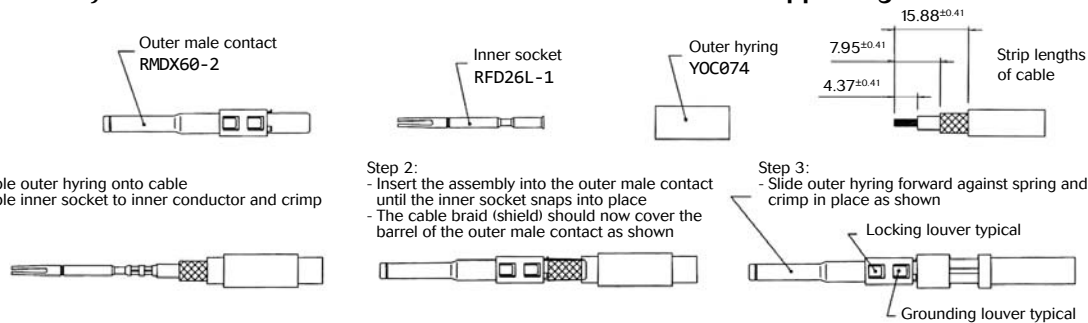

### Contact assembly with dielectric diameter under 1.4mm - with inner supporting sleeve

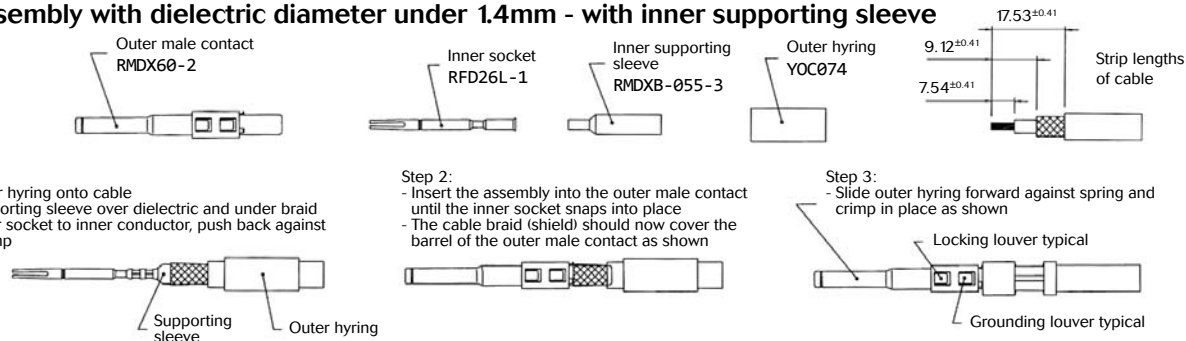

Note : all dimensions are in mm



## #16 coaxial contacts

### Multipiece female contact with coax cable

Cable reference	Contact	Hyring complementary components	Outer contact crimp tool		Inner contact crimp tool		Cable strip length		
			Crimp tool M10S1J		Crimp tool M10S1J		A	B	C
			Die set	Stop bushing	Die set	Stop bushing			
RG161U	Female: RCDXK1D28	YOC074	S221	SL471	S23D2	SL46D2	4.37	-	11.13
RG179							4.37		11.13
RG187U							4.37		11.13
RG188/U							4.37		11.13
RG174/U		S26D2			4.37		11.13		
RG178A/U		YOC074 + RMDXB0553			S23D2		6.35		11.13
RG196U					S23D2		6.35		11.13
AMPHENOL 21-598		YOC074			-		4.37		11.13
surprenant pn 8134					-		4.37		11.13

#### Multipiece kit details

RCDXK1D28 includes	Part	Description
	RCDX602D28	Outer contact
	RMD26L1D28	Inner contact
	YOC074	Outer hyring
	RCDXB0553	Inner supporting sleeve

#### Cable strip length

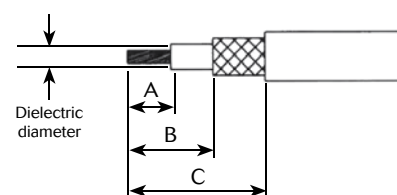

#### Contact assembly with dielectric diameter over 1.4mm - without inner supporting sleeve

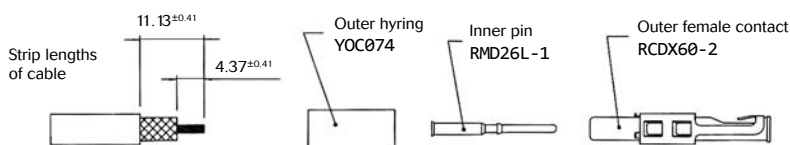

- Step 1:  
- Assemble outer hyring onto cable  
- Assemble inner pin to inner conductor and crimp

- Step 2:  
- Insert the assembly into the outer female contact until the inner pin snaps into place  
- The cable braid (shield) should now cover the barrel of the outer female contact as shown

- Step 3:  
- Slide outer hyring forward against spring and crimp in place as shown

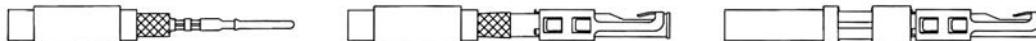

#### Contact assembly with dielectric diameter under 1.4mm - with inner supporting sleeve

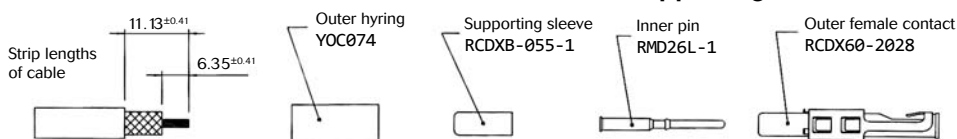

- Step 1:  
- Assemble outer hyring onto cable  
- Assemble supporting sleeve over dielectric and under braid  
- Assemble inner pin to inner conductor, push back against sleeve and crimp

- Step 2:  
- Insert the assembly into the outer female contact until the inner pin snaps into place  
- The cable braid (shield) should now cover the barrel of the outer female contact as shown

- Step 3:  
- Slide outer hyring forward against spring and crimp in place as shown

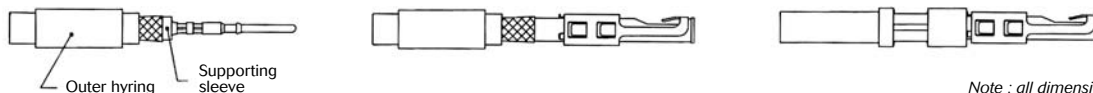

Note : all dimensions are in mm



## Coax cable with monocrimp contact cabling

Cable reference	Male contact	Female contact	Crimp tool	Die set	Stop bushing	Cable strip length			Inner conductor crimp		Braid crimp		
						A	B	C	g dim	t dim	g dim	t dim	
CDC PIN22939200	RMDX6046D28	RCDX6016D28	M1051J	S80	SL105	4.19	5.97	8.51	1.30/1.17	1.40/1.22	2.77/2.64	3.02/2.84	
CDC PIN22939200	RMDX6046D28	RCDX6016D28		S87	SL105	5.08	6.35	8.89	1.30/1.17	1.40/1.22	2.77/2.64	3.02/2.84	
CDC PIN245670000	RMDX6050D28	RCDX6016D28		S80	SL105	5.08	6.35	8.89	1.30/1.17	1.40/1.22	2.97/2.84	3.12/2.95	
KX21TVT (europe) RG178 B/U	RMDX6034D28	RCDX6034D28		S82	SL105	5.08	6.35	8.89	1.30/1.17	1.32/1.17	2.84/2.74	3.07/2.9	
RG178 / BU	RMDX6050D28	RCDX6016D28		S87	SL105	5.08	6.35	8.89	1.30/1.17	1.40/1.22	2.77/2.64	3.02/2.84	
ampex	RMDX6032D28	RCDX6032D28		S80	SL105	5.08	6.35	11.68	1.30/1.17	1.40/1.22	2.97/2.84	3.12/2.95	
TI PN 920580	RMDX6024D28	RCDX6024D28		S82	SL105	5.08	6.35	8.89	1.35/1.19	1.42/1.27	2.87/2.74	3.07/2.9	
RG174/U	RMDX6032D28	RCDX6032D28		S80	SL105	5.08	6.35	11.68	1.30/1.17	1.40/1.22	2.97/2.84	3.12/2.95	
Honeywell PN 58000062	RMDX6026D28	RCDX6026D28		S82	SL105	5.08	6.35	8.89	1.35/1.19	1.42/1.27	2.87/2.74	3.07/2.9	
RG188A/U	RMDX6036D28	RCDX6036D28		S80	SL105	5.08	6.35	11.68	1.30/1.17	1.40/1.22	2.97/2.84	3.12/2.95	
RG316/U	RMDX6036D28	RCDX6036D28		S80	SL105	5.08	6.35	11.68	1.30/1.17	1.40/1.22	2.97/2.84	3.12/2.95	
PRD PN 247AS-C123-001	RMDX6018D28	RCDX6018D28		M105G8 ASSY'Y TOOL DIE SET STOP BUSHING M1051J TOOL			5.08	6.35	8.89	1.22/1.17	1.35/1.22	2.92/2.79	3.12/2.97
PRD PN 247AS-C1251	RMDX6018D28	RCDX6018D28					5.08	6.35	8.89	1.22/1.17	1.35/1.22	2.92/2.79	3.12/2.97
raychem 5024A3111	RMDX6052D28	RCDX6052D28		S88	SL105	5.08	6.35	11.68	1.37/1.27	1.45/1.32	2.92/2.79		
raychem 5026e1614	RMDX6036D28	RCDX6036D28		M105G8 ASSY'Y TOOL DIE SET STOP BUSHING M1051J TOOL			5.08	6.35	8.89	1.22/1.17	1.35/1.22	2.92/2.79	3.12/2.97
JUDD C15013010902	RMDX6036D28	RCDX6036D28					5.08	6.35	8.89	1.22/1.17	1.35/1.22	2.92/2.79	3.12/2.97
inner cond. #30, braid diam 2.64	RMDX6050D28	-		S80	SL105	5.1	6.35	8.9	-	-	-	-	
inner cond. #30, braid diam 2.29	RMDX6050D28	-		S87	SL105	4.2	6.35	8.5	-	-	-	-	
inner cond. #28, braid diam 2.9	RMDX6032D28	RCDX6032D28		S80	SL105	5.1	6.35	11.7	-	-	-	-	
inner cond. #26, braid diam 1.78	RMDX6024D28	RCDX6024D28		S82	SL105	5.1	6.35	8.9	-	-	-	-	
inner cond. #26, braid diam 3.05	RMDX6026D28	RCDX6026D28	S82	SL105	5.1	6.35	8.9	-	-	-	-		

- Select appropriate cable and contact combination.
- Select appropriate crimp tooling (hand tool, S-die set, stop bushing).
- Strip coax cable to the designated wire strip lengths.
- Insert the stripped coax into the rear of the contact.
- Crimp the contact.

Cable strip length

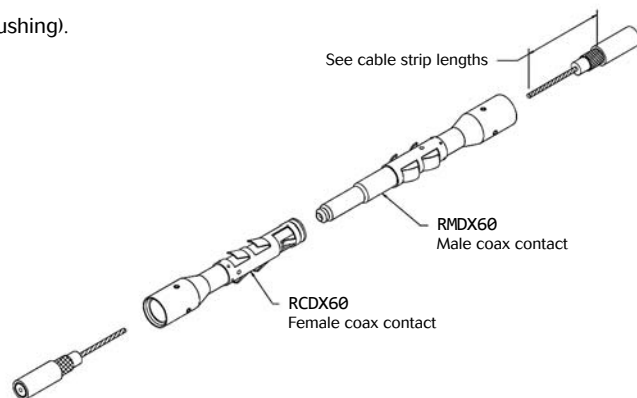
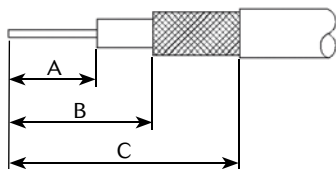

Note : all dimensions are in mm



## Glossary of terms

- **Clearance**

Per the IEC 60664-1 it is the shortest distance between two conductive parts even over the air.

- **Creepage distance**

Per the IEC 60664-1 it represents the shortest distance along the surface of the insulating material between two conductive parts.

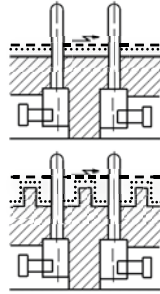

— — — — — Air gap  
 ..... Creepage distance

- **Working voltage**

Per the IEC 60664-1 it is the highest r.m.s. value of A.C. or D.C. voltage across any particular insulation which can occur when the equipment is supplied at rated voltage.

- **Rated impulse voltage**

Impulse withstands voltage value assigned by the manufacturer to the equipment or to a part of it characterizing the specified withstand capability of its insulation against transient overvoltage.

- **Working current**

It is the maximum continuous and not interrupted current able to be carried by all contacts without exceeding the maximum temperature of the insulating material.

- **Transient voltage**

Extract from the IEC 60664-1: Short duration overvoltage of a few millisecond or less, oscillatory or non-oscillatory, usually highly damped.

- **CTI (Comparative Tracking Index)**

The CTI value is commonly used to characterize the electrical breakdown properties of an insulating material. It allows users to know the tendency to create creepage paths. This value represents the maximum voltage after 50 drops of ammonium chloride solution without any breakdown.

- **RTI (Relative temperature Index):**

Extract from ULs website:

“Maximum service temperature for a material, where a class of critical property will not be unacceptably compromised through chemical thermal degradation, over the reasonable life of an electrical product, relative to a reference material having a confirmed, acceptable corresponding performance defined RTI.

- **RTI Elec:** Electrical RTI, associated with critical electrical insulating properties.

- **RTI Mech Imp:** Mechanical Impact RTI, associated with critical impact resistance, resilience and flexibility properties.

- **RTI Mech Str:** Mechanical Strength (Mechanical without Impact) RTI, associated with critical mechanical strength where impact resistance, resilience and flexibility are not essential”







# UTG Series



Stage - Light

Building automation & control



Industry

Off road - Mining  
Railway

Medical



# SOURIAU

[www.souriau-industrial.com](http://www.souriau-industrial.com)

[contactindustry@souriau.com](mailto:contactindustry@souriau.com)

**Esterline**  
Connection Technologies