

7W High Power LED



Features:

- Pb-Free soldering application
- RoHS compliance
- Multi-Chip package
- High reliability

Applications:

- Bulb
- Indoor decoration lighting
- Signal and symbol luminaries
- Reading lights
- Portable flashlight

Package Dimensions:

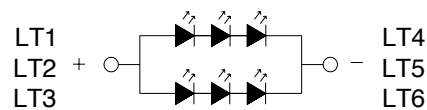
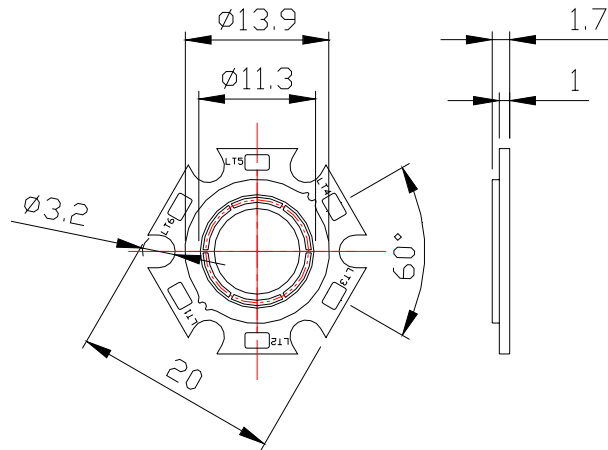

* All dimensions are in mm
* Tolerance: ±0.6mm

Ant Part No.	LED Chip		Lens Colour
	Material	Colour Coordinates	
703-0118	InGaN/Sapphire	White	Yellow diffused

Important Notice: This data sheet and its contents (the "Information") belong to the members of the Premier Farnell group of companies (the "Group") or are licensed to it. No licence is granted for the use of it other than for information purposes in connection with the products to which it relates. No licence of any intellectual property rights is granted. The Information is subject to change without notice and replaces all data sheets previously supplied. The Information supplied is believed to be accurate but the Group assumes no responsibility for its accuracy or completeness, any error in or omission from it or for any use made of it. Users of this data sheet should check for themselves the Information and the suitability of the products for their purpose and not make any assumptions based on information included or omitted. Liability for loss or damage resulting from any reliance on the Information or use of it (including liability resulting from negligence or where the Group was aware of the possibility of such loss or damage arising) is excluded. This will not operate to limit or restrict the Group's liability for death or personal injury resulting from its negligence. Multicomp is the registered trademark of the Group. © Premier Farnell plc 2011.



7W High Power LED



Absolute Maximum Ratings at Ta=25°C

Parameter	Symbol	Rating	Unit
Power Dissipation*	P _D	1260	mW
LED Junction Temperature*	T _j	120	°C
Reverse Voltage*	V _r	5	V
D.C. Forward Current*	I _f	350	mA
Peak Current (1 / 10 Duty Cycle, 0.1ms Pulse Width)*	I _f (Peak)	1000	mA
Storage Temperature Range	T _{stg.}	-40 to +85	°C
Soldering Temperature (1.6mm from body)	T _{sld.}	Dip Soldering: 260°C for 10sec. Hand Soldering: 350°C for 3sec.	
Electric Static Discharge Threshold (HBM)*	ESD	300	V

* The values are based on 1 die performance.

Electrical & Optical Characteristics:

Parameter	Symbol	Condition	Min.	Typ.	Max.	Unit	
Luminous Flux	Φ _v	I _F =1050mA	450	550		lm	
			Rank L1	450			550
			Rank L2	500			700
Forward Voltage	V _F	I _F =1050m		9.5		V	
			Rank V1	9.00			9.5
			Rank V2	9.51			10.0
			Rank V3	10.01			10.5
Correlated Colour Temperature	CCT	I _F =1050mA	5250	5750		K	
CIE Chromaticity Coordinates: X Axis	X	I _F =1050mA		0.3287			
CIE Chromaticity Coordinates: Y Axis	Y	I _F =1050mA		0.3417			
Reverse Current	I _R	V _r =5V			50	μA	
Colour Rendering Index	CRI	I _F =1050mA		72		R _a	
Viewing Angle at 50%		2θ _{1/2}		120		Deg	
Thermal Resistance Junction to Case		R _{θJ-c}		15		°C / W	

Notes: 1. The data is tested by IS tester.

2. Customer's special requirements are also welcome.

Important Notice: This data sheet and its contents (the "Information") belong to the members of the Premier Farnell group of companies (the "Group") or are licensed to it. No licence is granted for the use of it other than for information purposes in connection with the products to which it relates. No licence of any intellectual property rights is granted. The Information is subject to change without notice and replaces all data sheets previously supplied. The Information supplied is believed to be accurate but the Group assumes no responsibility for its accuracy or completeness, any error in or omission from it or for any use made of it. Users of this data sheet should check for themselves the Information and the suitability of the products for their purpose and not make any assumptions based on information included or omitted. Liability for loss or damage resulting from any reliance on the Information or use of it (including liability resulting from negligence or where the Group was aware of the possibility of such loss or damage arising) is excluded. This will not operate to limit or restrict the Group's liability for death or personal injury resulting from its negligence. Multicomp is the registered trademark of the Group. © Premier Farnell plc 2011.

www.element14.com

www.farnell.com

www.newark.com



Typical Electrical & Optical Characteristics Curves:
(25°C Ambient temperature unless otherwise noted)

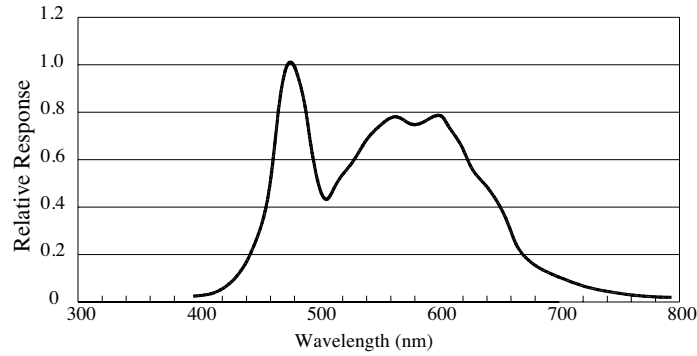
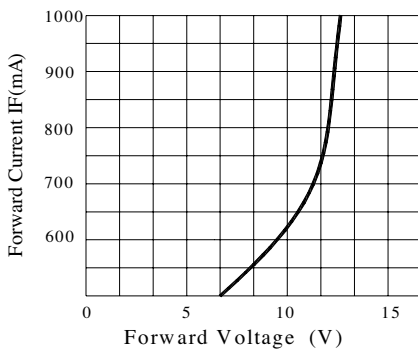
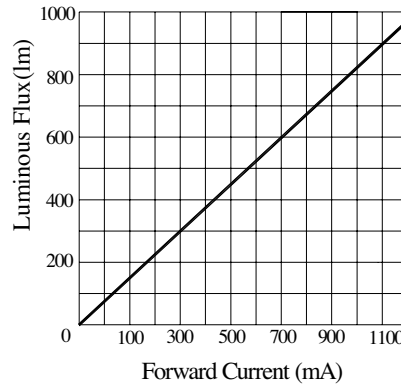

Fig.1 WHITE LED Spectrum VS. WAVELENGTH



Forward Current VS. Applied Voltage



Forward Current VS. Luminous Flux

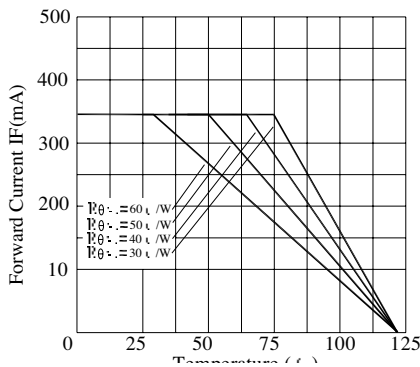

Ambient Temperature VS. Forward Current

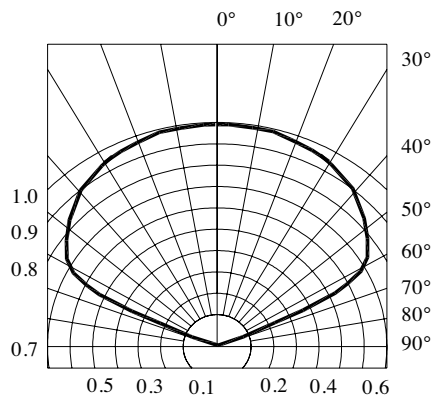

Radiation Diagram

Important Notice: This data sheet and its contents (the "Information") belong to the members of the Premier Farnell group of companies (the "Group") or are licensed to it. No licence is granted for the use of it other than for information purposes in connection with the products to which it relates. No licence of any intellectual property rights is granted. The Information is subject to change without notice and replaces all data sheets previously supplied. The Information supplied is believed to be accurate but the Group assumes no responsibility for its accuracy or completeness, any error in or omission from it or for any use made of it. Users of this data sheet should check for themselves the Information and the suitability of the products for their purpose and not make any assumptions based on information included or omitted. Liability for loss or damage resulting from any reliance on the Information or use of it (including liability resulting from negligence or where the Group was aware of the possibility of such loss or damage arising) is excluded. This will not operate to limit or restrict the Group's liability for death or personal injury resulting from its negligence. Multicomp is the registered trademark of the Group. © Premier Farnell plc 2011.



Chromaticity Coordinates Specifications for Bin Grading:

Bin	Rank					Bin	Rank				
WB6	X	0.3327	0.3394	0.3390	0.3324	WB7	X	0.3324	0.3390	0.3385	0.3324
	Y	0.3650	0.3719	0.3591	0.3519		Y	0.3519	0.3591	0.3465	0.3388
WC6	X	0.3264	0.3327	0.3324	0.3268	WC7	X	0.3268	0.3324	0.3324	0.3272
	Y	0.3551	0.3650	0.3519	0.3430		Y	0.3430	0.3519	0.3388	0.3305
WD6	X	0.3210	0.3264	0.3268	0.3218	WD7	X	0.3218	0.3268	0.3272	0.3227
	Y	0.3468	0.3551	0.3430	0.3353		Y	0.3353	0.3430	0.3305	0.3233
WE6	X	0.3164	0.3210	0.3218	0.3175	WE7	X	0.3175	0.3218	0.3227	0.3186
	Y	0.3395	0.3468	0.3353	0.3283		Y	0.3283	0.3353	0.3233	0.3169

Note: X, Y
Tolerance each Bin limit is ± 0.01

Chromaticity Coordinates & Bin Grading Diagram:

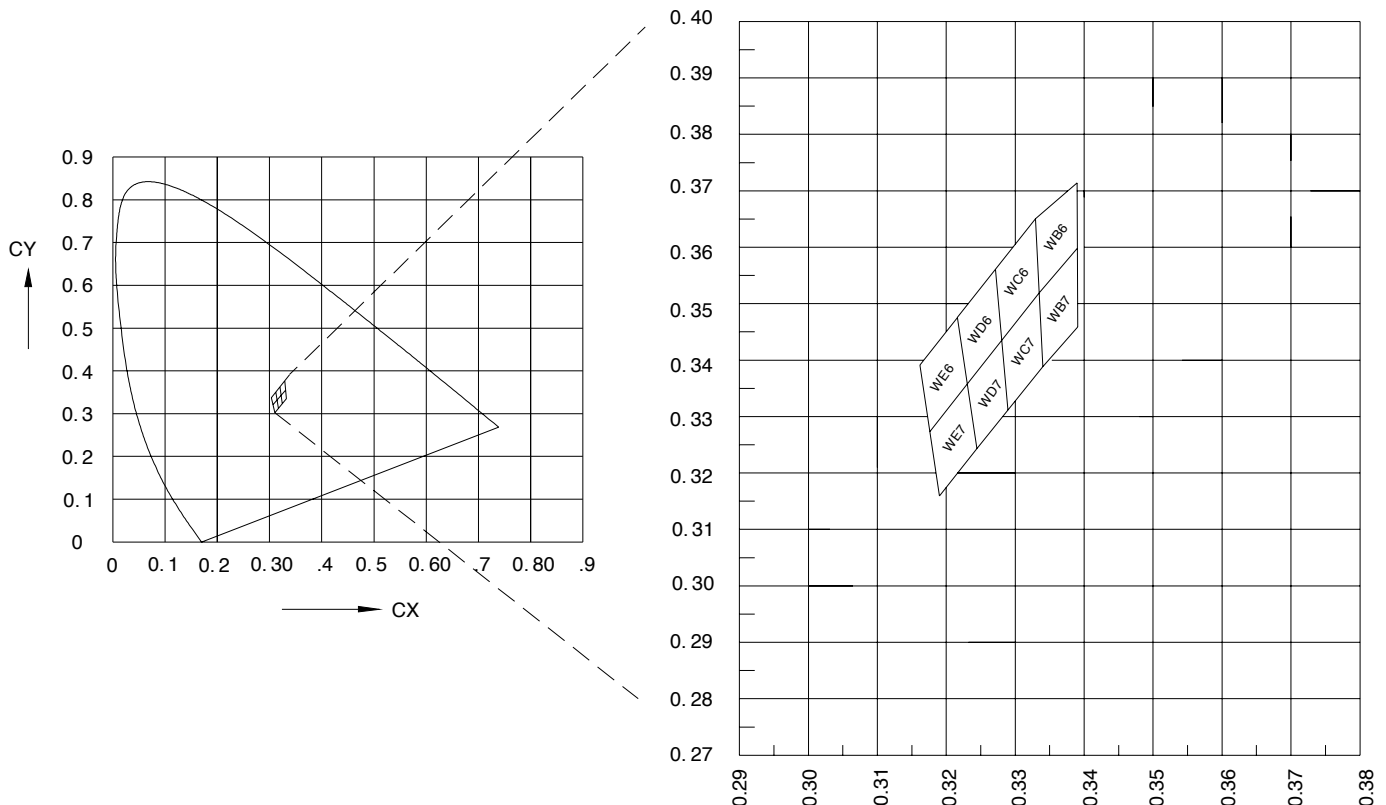

Important Notice: This data sheet and its contents (the "Information") belong to the members of the Premier Farnell group of companies (the "Group") or are licensed to it. No licence is granted for the use of it other than for information purposes in connection with the products to which it relates. No licence of any intellectual property rights is granted. The Information is subject to change without notice and replaces all data sheets previously supplied. The Information supplied is believed to be accurate but the Group assumes no responsibility for its accuracy or completeness, any error in or omission from it or for any use made of it. Users of this data sheet should check for themselves the Information and the suitability of the products for their purpose and not make any assumptions based on information included or omitted. Liability for loss or damage resulting from any reliance on the Information or use of it (including liability resulting from negligence or where the Group was aware of the possibility of such loss or damage arising) is excluded. This will not operate to limit or restrict the Group's liability for death or personal injury resulting from its negligence. Multicomp is the registered trademark of the Group. © Premier Farnell plc 2011.