



Specifications:

Inductance	: 47 μ H
Inductance Tolerance	: \pm 20%
DC Resistance Max	: 0.066 Ω
DC Current Rating	: 3A
Self Resonant Frequency	: 8MHz
Inductor Case Style	: SMD
No. of Pins	: 2
Lead Spacing	: 12.92mm
External Depth	: 7.11mm
External Length / Height	: 15.24mm
External Width	: 18.54mm
Series	: MCB

Electrical Characteristics (at 25°C)

100kHz 0.25V	L	47 μ H \pm 20%
at 25°C	DCR	66m Ω (Max.)
100kHz 0.25V I _{rms} = 3A	Δ T	Temperature Rise 40°C (Max.)

Operating temperature: -55°C to +130°C

Material List

No.	Item	Material Description
1	Core	T2 DR12.7 \times 5.6C B5.8 F3.3
2	Wire	\varnothing 0.45mm \times 1P 2UEWF 155°C
3	Solder (Lead Free)	Sn99.3%/Cu0.7%
4	Glue	TH320
5	Base	DAP HD127-3

Schematic Diagram



Note:

1. Wire $\varnothing 0.45\text{mm} \times 1\text{P 2UEWF } 155^\circ\text{C}$
2. 25.5TS (Reference)

Electric Characteristics

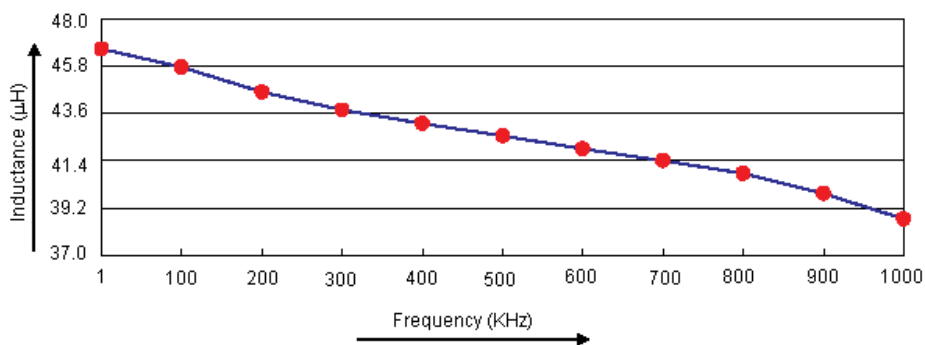
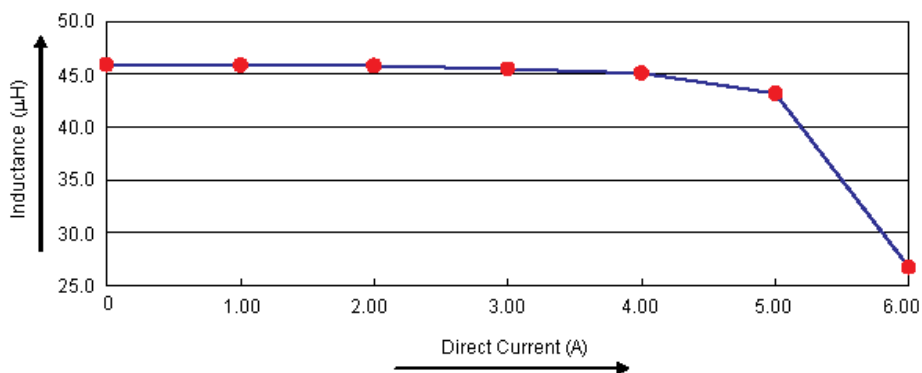

Configurations and Dimensions

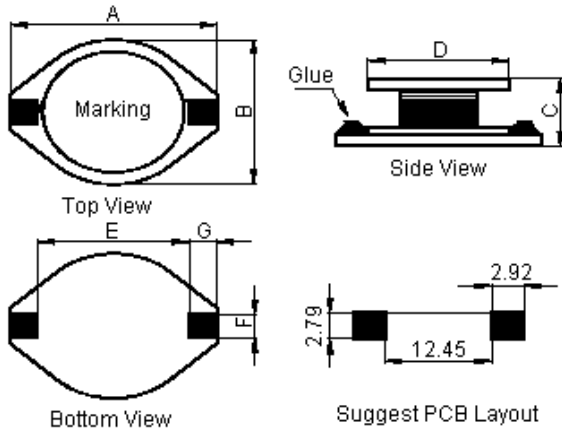

A	18.54mm	(Maximum)
B	15.24mm	(Maximum)
C	7.11mm	(Maximum)
D	12.7 ±0.3mm	-
E	12.92mm	(Reference)
F	2.54mm	(Reference)
G	2.54mm	(Reference)

Dimensions : Millimetres

Part Number Table

Description	Part Number
Inductor, 47µH, 20%, SMD	MCBF7330-470MU

Important Notice : This data sheet and its contents (the "Information") belong to the members of the Premier Farnell group of companies (the "Group") or are licensed to it. No licence is granted for the use of it other than for information purposes in connection with the products to which it relates. No licence of any intellectual property rights is granted. The Information is subject to change without notice and replaces all data sheets previously supplied. The Information supplied is believed to be accurate but the Group assumes no responsibility for its accuracy or completeness, any error in or omission from it or for any use made of it. Users of this data sheet should check for themselves the Information and the suitability of the products for their purpose and not make any assumptions based on information included or omitted. Liability for loss or damage resulting from any reliance on the Information or use of it (including liability resulting from negligence or where the Group was aware of the possibility of such loss or damage arising) is excluded. This will not operate to limit or restrict the Group's liability for death or personal injury resulting from its negligence. Multicomp is the registered trademark of the Group. © Premier Farnell plc 2012.