



Your Single Source  
For Value-Added  
Plastics Packaging



PRODUCT CATALOG

## Your Single Source For Value-Added Plastics Packaging

### Overview

Flambeau Packaging Solutions is an industry leader in design, development and manufacture of blow molded and injection-molded plastic storage products. We offer the industry's largest selection of stock cases and boxes for storage solutions. We pride ourselves as a market leader in contract manufacturing services for a wide range of demanding industrial applications.

### About Our Company

Flambeau Packaging Solutions is part of Flambeau Products Corporation, a member of the Nordic Group of Companies. Flambeau manufacturing facilities are located throughout the United States. Overall, the Nordic Group includes over 2,000 associates and has sales in excess of \$350 million.

### Design and Development

At Flambeau, we work closely with our customers to develop packaging concepts and designs to meet your specific needs. Our capabilities include design, engineering, tool-building, injection and blow-molding and finishing/decorating operations.

### Customer Service

Our customer service representatives help you solve problems. Our toll-free number places you in direct contact with professionals who can provide answers to your packaging needs. Whether it is technical assistance, or simply answers to a questions, our staff is available when you need them.

### Products

Flambeau offers more than 300 different sizes and styles of stock injection molded and blow molded boxes and carrying cases. For semi-custom cases, we have hundreds of options which can be tailored to fit your

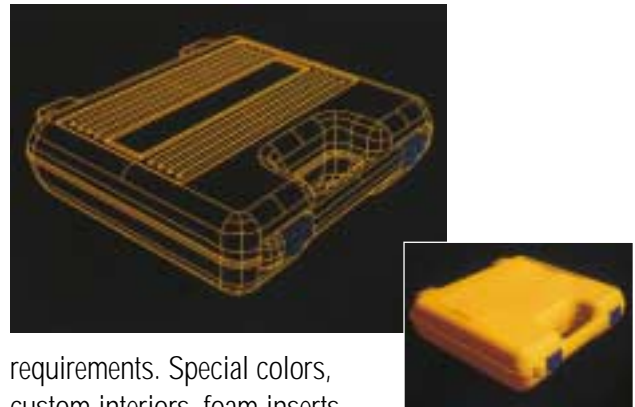

requirements. Special colors, custom interiors, foam inserts, and a wide range of handles, latches and package accessories can be drawn upon to meet your needs.

### ISO 9001 Accreditation

Flambeaus' commitment to ongoing and continuous quality improvement is made possible by adhering to the strictest quality standards in all aspects of our business. From design and purchasing to inspections and testing controls, Flambeau continually meets or exceeds established standards.



### Flambeau Manufacturing Locations:

- Redlands, California
- Weldon, North Carolina
- Deerfield, Wisconsin
- Columbus, Indiana
- Middlefield, Ohio
- Sauffillo, Mexico

If our available stock and semi-custom stock containers don't fit your application, we offer total custom manufacturing capabilities. We can handle every detail from "Art to Part."



## Diamondback™ Tradesman's Case Utility Workstation™



NEW



Diamondback boxes are designed with a modern contoured style and manufactured from crystal clear styrene for stylish appeal and merchandising of your products. The all new Diamondbacks are excellent for use with candy, crafts, beauty aids and can be hot stamped with your name or logo.

- Sleek design for improved merchandising.
- Crystal Clear Styrene material, as clear as glass.
- Improved hinge strength and easy open lid.
- Stacking feet for neater displays.
- Applications include: food products, electronic parts, medical & lab supplies, hobby parts, office supplies, precision parts, small screws & washers. (See page 9)



Flambeau has designed a new case with special locking safety latches that make it a perfect case for handguns, hand and power tools, such as cordless drills, cordless screwdrivers, detail sanders, wrench sets and socket sets. Available as a custom case with your product logo or as a standard case for storage. Our new Tradesman's case will add value to your product's presentation. (See page 8)



Working on projects will be easier utilizing Flambeau's Utility Workstation. Ideal for toolrooms, MRO areas, temporary storage, and for servicing vehicles. This mobile system includes a sliding lid, which can be used as a work surface or removed and conveniently stored on the side of the Workstation. The lid can also be locked to secure items in the top tray. Two large compartmented cases fit in the top tray for organized parts storage. Additional flexibility comes from attachable bins and bulk storage bottom tray. (See page 11)



## Custom Capabilities

Custom packaging delivers a high quality message to your customers. Flambeau offers you hundreds of stock cases and boxes to choose from that can easily be customized. In-house design and tooling capabilities also support complete customization.

**Express Service<sup>SM</sup>**

Infinity<sup>™</sup> Cases 2  
 Most Popular Pin Hinge Case 3  
 Foam Options 3  
 Special Storage Products 4  
 Conductive Cases w/ Standard Antistatic Foam 5  
 Medical Products 6  
 Utility Boxes and Tool Boxes w/Tote Trays 7  
 Textured Living Hinge Boxes 8  
 Diamondback<sup>™</sup> Crystal Clear Styrene Boxes 9  
 Heavy-Duty Clear K-Resin<sup>®</sup> Boxes 10  
 Heavy-Duty Clear Precision Style Boxes 10  
 Small Satchel-Style Compartmented Cases 11  
 Utility Workstation<sup>™</sup> 11

**Protective Cases**

Blow Molded Protective Cases 13-17  
 Infinity<sup>™</sup> Cases 13  
 Pin Hinge Cases 14  
 Integral Hinge Cases 14  
 Overall Dimensions 15  
 Spectra Molding 16  
 Additional Styles of Custom Blow Molded Cases 19  
 Custom Options 19  
 Window Options 20

**Compartmented Boxes**

Infinite Divider System<sup>™</sup> 23  
 Diamondback<sup>™</sup> Boxes 23  
 Precision Box 23  
 Mighty-Tuff<sup>™</sup> Boxes 24  
 Polypropylene Boxes 24  
 Textured Integral Hinge Boxes 24  
 K-Resin<sup>®</sup> Boxes 24  
 Infinite Divider System<sup>™</sup> 25  
 IDS<sup>™</sup> Cabinet 26  
 Tuff-Tainers 27  
 A-Series Styrene Boxes 27  
 How to Locate the Box You Need 28  
 1 Compartment 29-30  
 2 Compartments 31  
 3 Compartments 31  
 4 Compartments 32  
 5 Compartments 33  
 6 Compartments 34  
 7 Compartments 35  
 8 Compartments 36  
 9 Compartments 36  
 10 Compartments 37  
 11 Compartments 37  
 12 Compartments 38

13 Compartments 39  
 17 Compartments 39  
 18 Compartments 40  
 24 Compartments 41  
 36 Compartments 41  
 Outside Dimensions 42-43

**Mobile Storage Systems**

Utility Workstation<sup>™</sup> 45  
 Utility Boxes 46  
 Utility Boxes w/ Lift-Out Trays 46  
 Utility Boxes w/ Cantilever Trays 47  
 Utility Tote 48  
 Utility Bench Box 48  
 Expandable Building Box 49  
 Stand 'N Store Step Stool 49  
 Carry Packs 50  
 Drawer Cabinets and Chests 51

**Stationary Storage Systems**

Large Compartmented Cases 53  
 Small Compartmented Cases 54  
 Bin Storage Systems 55  
 Plastic Frame Storage Cabinets 56-57

**Medical Products**

PM8040 59  
 Drug Kits, Paramedic Boxes 60  
 First Aid Boxes 60  
 Drawer Cabinets 61  
 Instrument Boxes 61  
 Test Tube Storage 62

**Conductive Products**

Injection Molded Boxes 64  
 Blow Molded Cases 64  
 Conductive Cases and Storage Systems Spec Sheet 65-66

**Custom Capabilities**

Labels 68  
 Hot Stamping 68  
 Pad Printing 69  
 Custom Cores for Injection Molded Products 69  
 Custom Interiors for Blow Molded Cases 69  
 Custom Colors 69  
 Blow Molded Case Design 70

Request For Quote 71-72



# Express Service<sup>SM</sup>

What You Need,  
When You Need It.

Flambeau's Express Service line of stock products is our way of providing the industry's most comprehensive selection of "off-the-shelf" carrying cases, compartmented boxes, and specialty storage containers for immediate shipment. From a single case to several hundred tool boxes, Express Service offers what you need, when you need it. (Certain products require quantity orders.)

To place your order, select the item you need and the corresponding stock number. Call toll free 1-800-344-5716 to place your order. For your convenience, we accept Master Card, VISA and American Express.

**In-Stock Products for Immediate Shipment**



**Infinity<sup>TM</sup>  
Cases**



**The next generation of blow molded cases**

Designed to succeed the famous Airmold® P-Series tradition. The contemporary design of the new INFINITY™ Case not only looks professional, it also has the performance to match! Built-in features include:

- Cam-over ABS latches.
- Textured finish to reduce dents and scratches.
- Stock foam and custom options.
- Lid dust seal.
- Interlock joints to add strength.
- Applications Include: Power Tool Storage, Hand Tool Storage, Instrumentation Equipment, Audio/Visual Equipment, Medical Products.

**Ordering Information**

Description	Stock No.	Outside Dimensions Length x Width x Depth	Inside Dimensions Length x Width x Depth	Features
Infinity™ 12	50250	12 x 9 x 2-1/2	10-1/2 x 7-1/2 x 1-13/16	Double Wall
Infinity™ 14	50330	14 x 10-1/2 x 4	12-1/2 x 9 x 3-5/16	Double Wall
Infinity™ 14	50350	14 x 10-1/2 x 5	12-1/2 x 9 x 3-5/16	Integral Hinge
Infinity™ 14	50351	14 x 10-1/2 x 5	12-1/2 x 9 x 3-5/16	Pin Hinge
Infinity™ 17	50410	17 x 14-1/4 x 4-1/2	15-1/2 x 11-3/16 x 3-1/2	Double Wall
Infinity™ 17	50430	17 x 14-1/4 x 6-1/2	15-1/2 x 11-3/16 x 5-1/2	Double Wall
Infinity™ 20	50470	20 x 15 x 5-1/2	18-1/2 x 13-3/4 x 4-1/2	Double Wall; Fold Down Handle
Infinity™ 20	50474	20 x 15 x 5-1/2	18-1/2 x 13-3/4 x 4-1/2	Holds Tool Pallets; 2 Lid Stays; Shoulder Strap; and Metal Latches
Infinity™ 20	50500	20 x 15 x 8-1/2	18-1/2 x 13-3/4 x 7-1/2	Double Wall; Fold Down Handle

**Foam Options**

If you require extra product protection, Flambeau provides three foam options:

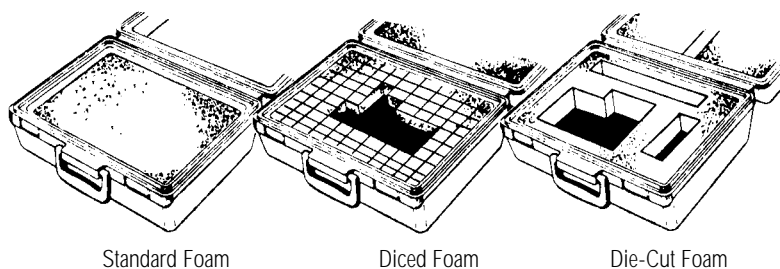

Standard Foam

Diced Foam

Die-Cut Foam

**In-Stock Products for Immediate Shipment**

**No  
Minimums**

## Most Popular Pin Hinge Style Blow Molded Cases

Flambeau manufacturing facilities in North Carolina and California stock the most popular sizes of blow molded cases for immediate delivery (see table below). Routed interiors with standard foam sets are available as part of our Express Service<sup>SM</sup>.

### Ordering Information

Stock Number	Description	Exterior Dimensions (inches)	Interior Dimensions	Special Features
50032	PC 3-9/16	8-1/2 x 7-13/16 x 3-9/16	7-9/16 x 5-7/8 x 3-1/4	single latch
50048	PH 3-1/8	10 x 8-5/16 x 3-1/8	9-1/8 x 6-1/2 x 2-13/16	single latch
50025	PQ 3-7/8	12-1/4 x 8-13/16 x 3-7/8	11-3/8 x 7 x 3-9/16	double latch
50024	PV 4	13-1/2 x 10-13/16 x 4	12-11/16 x 8-15/16 x 3-11/16	double latch
50026	PV 5-1/8	13-1/2 x 10-13/16 x 5-1/8	12-11/16 x 8-15/16 x 4-3/4	double latch
50030	PW 4	15-1/2 x 13-5/16 x 4	14 x 10-3/4 x 3-1/2	double latch
50053	PW 6-1/4	15-1/2 x 13-5/16 x 6-1/4	14 x 10-3/4 x 5-3/4	metal lock latch
50050	PX 5	18-1/2 x 15-9/16 x 5	17 x 13 x 4-1/2	metal lock latch
50051	PX 8	18-1/2 x 15-9/16 x 8	17 x 13 x 7-3/8	metal lock latch
50045	PZ 4-1/2	26 x 16-9/16 x 4-1/2	24-1/2 x 13 x 4	routed base
50088	PZ 8	26 x 15-9/16 x 8	24-1/2 x 13 x 7-3/8	routed base

### FEATURES

- Molded from high density polyethylene.
- All cases are equipped with fold down handles.
- Resistant to gas, oil, and most household chemicals.
- Usable in a wide temperature range.
- Will not rust or corrode.
- Scratch and dent resistant.
- Cases are black with textured exteriors.

## Foam Options

If you require extra product protection, Flambeau provides three foam options:

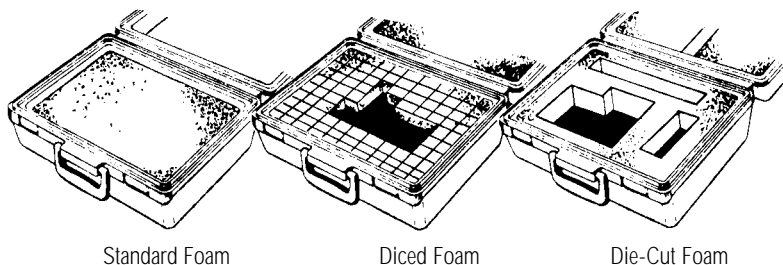

Standard Foam

Diced Foam

Die-Cut Foam



***In-Stock Products for Immediate Shipment***



## Special Storage Products

With Flambeau, you can count on quality products, innovative packaging and exceptional value!



Work Center Fold™



Tailgator™

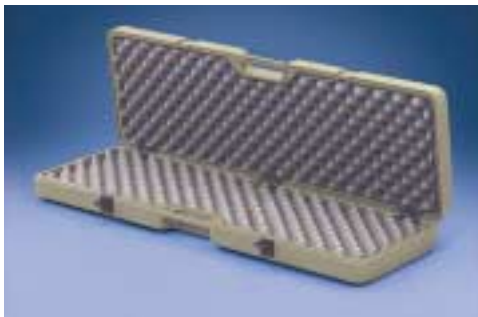

Large Locker Case



Expandable Tube

### Ordering Information

Stock Number	Description	Inside Dimensions (inches) Length x Width x Depth	Features
50077	Expandable Tube	3-1/4 diameter x 61-1/2 to 85-1/2 length	Extends to hold very long items
50063	Large Locker Case	51-1/2 x 8-7/8 x 3-3/4	Locking metal latches; double wall construction
50064	Extra Wide Locker Case	51-1/2 x 12-7/8 x 3-3/4	Locking metal latches; double wall construction
50084	Work Center Fold™	24 x 48 work surface; 4-1/2 deep closed	Contains multiple storage areas
50065	Tailgator™ (With Interior)	35-3/4 x 16-3/4 x 10-1/4	Includes 2 dividers and 1 shelf
50066	Tailgator™ (Without Interior)	35-3/4 x 16-3/4 x 10-1/4	No dividers or shelf
50067	Divider for Tailgator™	---	Divider only
50068	Shelf for Tailgator™	---	Shelf only



***In-Stock Products for Immediate Shipment***

**No  
Minimums**

## Conductive Cases with Standard Antistatic Foam

### Features Include:

- Full two year warranty.
- Antistatic or conductive foam available for installation.  
(Conductive foam quoted separately)
- Molded from a proprietary high density polyethylene carbon loaded blend of materials.
- Conductive <math> < 10^5 </math> Ohms/in<sup>2</sup>.
- Anti-Static: 10<sup>9</sup> to 10<sup>13</sup> Ohms/in<sup>2</sup>.
- Faraday Cage Protection.

### Ordering Information

Stock Number	Description	Inside Dimensions L x W x H
50019	5 x 3	5-1/16 x 2-3/4 x 1
50018	7 x 5	6-1/2 x 4-3/4 x 1-1/16
50036	RA 1-3/4	6-3/4 x 5 x 1-3/16
50014	9 x 7	8-15/16 x 6-5/8 x 1-1/4
50015	12 x 8	11-7/8 x 8-3/16 x 1-1/4
50016	13 x 11	12-3/4 x 10-1/2 x 1-3/4
50017	15 x 6	15 x 6-1/2 x 2
50023	18 x 14	17-1/2 x 13-1/2 x 1-5/16
50021	18 x 18	18-7/16 x 17-11/16 x 1-15/16
50035	VME 12 x 9	12-3/8 x 8-15/16 x 1-1/4 molded interior

**In-Stock Products for Immediate Shipment**

## Medical Products

Our extensive line of stock medical products is available in a wide variety of styles, sizes and configurations to suit your needs.

Manufactured from rustproof, dentproof and chemical resistant co-polymer resins.



## First Aid Boxes

- 3 popular styles.
- PM1702 features removable tray - great for bulk supplies.
- PM1772 features 8 large compartments - ideal for bandages and larger items.
- PM1872 features 2 tip-proof trays, 9 compartments.

Model Number	L x W x D	Number of Compts.	Pack Per Ctn.
PM1702	16-1/2 x 8-3/4, x 7-1/2	2	4
PM1772	16-1/2 x 8-3/4, x 7-1/2	8	4
PM1872	17-5/8 x 10-1/4, x 8-3/4	9	4



## Instrument Boxes

- 5 standard sizes.
- Ideal for small or delicate equipment.
- Durable polypropylene construction.
- Safe for autoclaves.

Model Number	L x W x D	Standard Colors	Number of Compts.	Pack Per Ctn.
V301	7 -1/4 x 3-1/2 x 1-1/8	Orange	1	36
V401	8-3/8 x 4-1/2 x 1-11/16	Sand	1	24
V501	10-3/8 x 4-1/2 x 1-11/16	Sand	1	24
V601	14 x 6-1/4 x 2-1/2	Sand	1	12
V701	17-1/2 x 7-3/4 x 2-3/8	Sand	1	6

**In-Stock Products for Immediate Shipment**

## Utility Boxes and Utility Boxes with Lift-Out Trays

Flambeau offers a versatile line of rugged utility and tool boxes for a multitude of packaging and storage needs. These products are lightweight, rust-proof, dent-proof and scratch-resistant. Positive latches, tough recessed handles and tongue and groove construction provide the best value in our tool box line.

### Ordering Information/Utility Boxes

Stock Number	Description	Exterior Dimensions	Std. Pack	Weight (lbs.)
6734UB	1100	12-1/8 x 7-1/4 x 4-1/2	6	6.9
6736UB	1200	12-1/8 x 7-1/4 x 5-1/2	6	7.8
6742UB	1400	14-3/8 x 8 x 7	6	11.8
6746UB	1700	16-3/8 x 8-5/8 x 7	4	10.2
6752UB	1800	17-1/2 x 10-1/4 x 8-1/2	4	13.7
6760UB	2100	19 x 11-1/2 x 10-1/2	2	10.9

All stock boxes are gray color. Minimum order is standard package quantities.

### Ordering Information/Utility Boxes with Lift-Out Trays

Stock Number	Description	Exterior Dimensions	Std. Pack	Weight (lbs.)
6744HS	14800-2	14-1/2 x 7-1/4 x 5-3/4	6	12.0
6748HS	17800-2	16-5/8 x 8-3/4 x 7-1/8	4	14.0
6757HS	19800-2	20-1/4 x 8-7/8 x 8-3/8	4	18.0
6759HS	23800-2	23 x 10-1/2 x 11-3/8	2	14.0
6754TC	27800-2	27-1/2 x 13-3/4 x 14	2	22.0

**In-Stock Products for Immediate Shipment**

## Textured Living Hinge Boxes

Flambeau's line of full-length textured living hinge (often referred to as Integral Hinge) boxes are ideal for storing and protecting. These boxes offer an excellent value for your money. Features include a snap-lock lid for a tight, even closure and a smooth label area for imprinting or branding. These boxes are ideal for the autoclave process (sterilization of instruments) where high temperatures will not warp or destroy the box.

**Ordering Information**

Stock Number	Description	Outside Dimensions	Std. Pack	Weight (lbs.)
6650VB	V301PT	7-1/4 x 3-1/2 x 1-1/8	36	6.0
6152VB	V401	8-3/8 x 4-1/2 x 1-3/4	24	8.6
6160VB	V501	10-3/8 x 4-5/8 x 1-3/4	24	9.9
6667VB	V601	14 x 6-1/4 x 2-1/2	12	11.8
6172VB	V701	17-1/2 x 7-3/4 x 2-3/8	6	9.3

All stock boxes are color sand. Minimum order is standard package quantities.



**NEW**

## Trademan's Case

The Trademan's Case is loaded with features designed to protect your products while giving you the convenience of mobility.

- Dual sliding, lockable mechanical latches (one or both may be locked).
- Can be nested or stand upright for displays.
- Colors available (lid & base must be the same) - Minimums Apply.
- Stock or custom foam options are available.
- Custom hot stamping available - Minimums Apply.
- Dust seal.

**Ordering Information**

Stock Number	Description	Dimensions	Pk. per carton	Weight
6780TC	14" Trademan's Case	14 x 11 x 3-1/4	14	10 lbs.
6781TC	14" Trademan's Case w/Foam	14 x 11 x 3-1/4	14	15 lbs.
6785TC	17" Trademan's Case	17 x 12 x 4	6	13 lbs.

Minimum order is standard pack quantities.



**In-Stock Products for Immediate Shipment****NEW**

## Diamondback™ Crystal Clear Styrene Boxes

Diamondback™ boxes are designed with a modern contoured style and manufactured from crystal clear styrene for stylish appeal and merchandising of your products. The all new Diamondbacks™ are excellent for use with candy, crafts, beauty aids and can be hot stamped or pad printed with your name or logo.

- Sleek design for improved merchandising.
- Crystal Clear Styrene material, as clear as glass.
- Improved hinge strength and easy open lid.
- Stacking feet for neater displays.
- Applications include: food products, electronic parts, medical & lab supplies, hobby parts, office supplies, precision parts, small screws & washers, beads and art supplies.

**Ordering Information**

Stock Number	Description	Outside Dimensions	Number of Compartments	Std. Pack	Std. Pack Weight (lbs.)
6708CD	DB200	8-3/4 x 4-7/8 x 1-3/8	18	48	21.5
6710CD	DB201	8-3/4 x 4-7/8 x 1-3/8	12	48	21.5
6712CD	DB203	8-3/4 x 4-7/8 x 1-3/8	6	48	18.5
6714CD	DB204	8-3/4 x 4-7/8 x 1-3/8	12	48	21.0
6716CD	DB206	8-3/4 x 4-7/8 x 1-3/8	1	48	21.0
6718CD	DB208	8-3/8 x 4-7/8 x 1-3/8	12	48	21.3
6722CD	DB210	7-5/16 x 3-7/8 x 1-5/16	9	50	15.3
6724CD	DB211	7-5/16 x 3-3/8 x 1-5/16	6	50	12.4
6721CD	DB213	7-5/16 x 3-7/8 x 1-5/16	10	50	15.8
6732CD	DB216	7-5/16 x 3-7/8 x 1-5/16	1	50	12.4
6734CD	DB217	7-5/16 x 3-7/8 x 1-5/16	7	50	15.1
6736CD	DB219	7-5/16 x 3-7/8 x 1-5/16	12	50	12.4
6740CD	DB220	4-7/8 x 3-1/4 x 1-1/8	6	48	5.9
6742CD	DB221	4-7/8 x 3-1/4 x 1-1/8	4	48	5.8
6744CD	DB226	4-7/8 x 3-1/4 x 1-1/8	1	48	5.3
6746CD	DB228	4-7/8 x 3-1/4 x 1-1/8	8	48	6.0
6752CD	DB601	11 x 6-3/4 x 1-3/4	1	24	24.1
6758CD	DB606	11 x 6-3/4 x 1-3/4	6	24	25.6
6764CD	DB613	11 x 6-3/4 x 1-3/4	13	24	27.8
6766CD	DB618	11 x 6-3/4 x 1-3/4	18	24	29.1

Minimum order is standard pack quantities.

***In-Stock Products for Immediate Shipment***

## Heavy-Duty Clear K-Resin<sup>®</sup> Boxes

K-Resin<sup>®</sup> is a tough, sturdy transparent material. Boxes made from K-Resin<sup>®</sup> are ideal for industrial applications where good impact resistance and transparency is needed. Specific applications include storage for fasteners, electronic parts, medical supplies and precision components and parts.

### Ordering Information

Stock Number	Description	Outside Dimensions	Number of Compartments	Std. Pack	Std. Pack Weight
6616KB	K206	8-1/4 x 4-1/2 x 1-3/8	1	24	8.0 lbs.
6644KB	K226	4-5/8 x 3 x 1-1/8	1	36	5.1 lbs.
6652KB	K601	11 x 6-3/4 x 1-3/4	1	24	22.7 lbs.
6672KB	K801	13-1/8 x 9 x 2-5/16	1	12	18.9 lbs.

Minimum order is standard pack quantities.



## Heavy-Duty Clear Precision Style Boxes

These new boxes from Flambeau are precision-engineered for small specialty items. These boxes feature a brass rust-proof hinge pin and are molded from a sturdy acrylic material. We can also mold these in colors and hot-stamp with your name or logo for custom orders. Foam and vacuum-formed inserts available for stationary storage and product presentation.

### Ordering Information

Stock Number	Description	Outside Dimensions	Number of Compartments	Std. Pack	Std. Pack Weight
6240AA	2020-2	3-7/8 x 2-3/4 x 1-1/8	1	24	3.5 lbs.
6730AA	3030-2	5-7/8 x 3-7/8 x 1-5/16	1	24	9.2 lbs.
6740AA	4040-2	8-3/8 x 4-1/2 x 1-1/2	1	24	10.4 lbs.

Minimum order is standard pack quantities.

**In-Stock Products for Immediate Shipment**

## Small Satchel-Style Compartmented Cases

Flambeau offers a variety of handsome satchel-style cases molded from tough copolymer resins. These cases include a comfortable handle, double positive latches, pinned hinges and a translucent cover. Customizing is available for certain minimums.

### Ordering Information

Stock Number	Description	Outside Dimensions	Number of Compartments	Std. Pack	Std. Pack Weight
6771UA	711-2	15-1/2 x 11-3/4 x 2-1/2	1	12	26 lbs.
6770PA	724-2	15-1/2 x 11-3/4 x 2-1/2	9-24	12	35 lbs.

Minimum order is standard pack quantities.



## Utility Workstation<sup>™</sup>

Working on projects will be easier utilizing Flambeau's Utility Workstation<sup>™</sup>. Ideal for toolrooms, MRO areas, temporary storage and for servicing vehicles. This mobile system includes a sliding lid, which can be used as a work surface or removed and conveniently stored on the side of the Workstation. The lid can also be locked to secure items in the top tray. Two large compartmented cases fit in the top tray for organized parts storage. Additional flexibility comes from attachable bins and bulk storage bottom tray, purchased separately. Capacity 300 lbs.

### Ordering Information

Stock Number	Description	Dimensions	Pk. per carton	Weight
8510ST	Utility Workstation <sup>™</sup>	29 x 22 x 40	1	38 lbs.

Minimum order is standard pack quantities.

# Protective Cases

Flambeau's line of blow molded cases provide you with value, image, protection and presentation options. Double wall construction allows exact product fit and protection. Custom-molded interiors can match your product exactly. For the optimum in flexibility, the new Infinity™ Series offers the ultimate performance and value with its sleek, contemporary design.





# BLOW MOLDED PROTECTIVE CASES



## Infinity™ Cases



### The next generation of blow molded cases

Designed to succeed the famous Airmold® P-Series tradition. The contemporary design of the new INFINITY™ Case not only looks professional, it also has the performance to match! Built-in features include:

- Cam-over ABS latches (metal latches optional).
- Textured finish to reduce dents and scratches.
- Stock foam and custom options.
- Lid dust seal.
- Interlock joints to add strength.
- Applications Include: Power Tool Storage, Hand Tool Storage, Instrumentation Equipment, Audio/Visual Equipment, Medical Products.

### Ordering Information

Description	Stock No.	Outside Dimensions Length x Width x Depth	Inside Dimensions Length x Width x Depth	Features
Infinity™ 12	20250	12 x 9 x 2-1/2	10-1/2 x 7-1/2 x 1-13/16	Double Wall
Infinity™ 14	20330	14 x 10-1/2 x 4	12-1/2 x 9 x 3-5/16	Double Wall
Infinity™ 14	20350	14 x 10-1/2 x 5	12-1/2 x 9 x 3-5/16	Integral Hinge
Infinity™ 14	20351	14 x 10-1/2 x 5	12-1/2 x 9 x 3-5/16	Pin Hinge
Infinity™ 17	20410	17 x 14-1/4 x 4-1/2	15-1/2 x 11-3/16 x 3-1/2	Double Wall
Infinity™ 17	20430	17 x 14-1/4 x 6-1/2	15-1/2 x 11-3/16 x 5-1/2	Double Wall
Infinity™ 20	20470	20 x 15 x 5-1/2	18-1/2 x 13-3/4 x 4-1/2	Double Wall; Fold Down Handle
Infinity™ 20	20474	20 x 15 x 5-1/2	18-1/2 x 13-3/4 x 4-1/2	Holds Tool Pallets; 2 Lid Stays; Shoulder Strap; and Metal Latches
Infinity™ 20	20500	20 x 15 x 8-1/2	18-1/2 x 13-3/4 x 7-1/2	Double Wall; Fold Down Handle



## BLOW MOLDED PROTECTIVE CASES



### Pin Hinge Cases



#### Pin Hinge Cases

Our P-Series (for Pin Hinge) product line consists of more than 100 sizes. Selected models have a removable lid option permitting the base and the lid to be used separately. Injection molded latches. Standard logo recess for customization to your needs.



### Integral Hinge Cases



#### Integral Hinge Cases

Our R-Series (for Integral Hinge) product line represents the best value in a blow molded case. Flambeau's offering includes more than 100 sizes. This one-piece design has a built-in hinge and latch that will withstand more than 5,000 flexes without failure. Standard logo recess for customization to fit your needs.



# P-Series

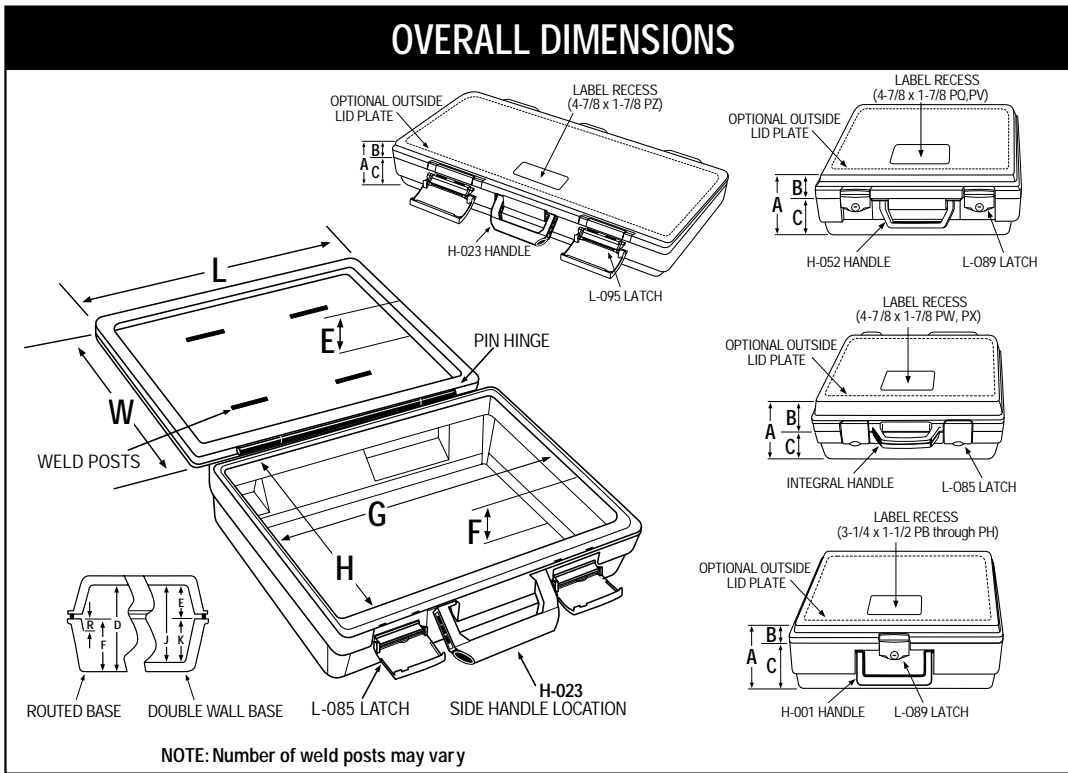

# R-Series

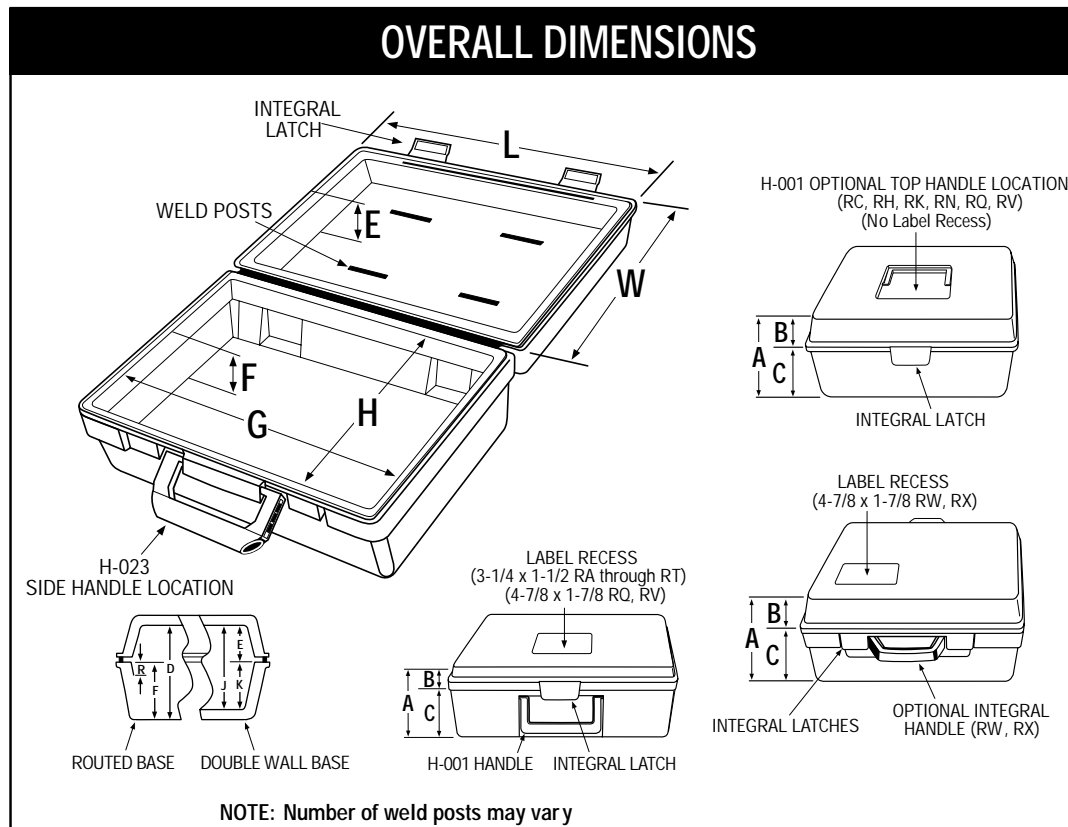

# Spectra Molding™

PROCESS

## SPECTRAMOLDING™ by Flambeau®

Flambeau revolutionizes plastic case decorating with the new SPECTRAMOLDING™ process. This proprietary process, only available from Flambeau, offers colorful graphic images and text to be permanently molded into the case. The result is a spectacular merchandising advantage no other molder can provide.

- High Resolution Graphics for eye-catching packaging.
- Conforms to a variety of textures and surfaces.
- Can be UV protected.
- Eliminates the need for adhesive labels and/or chipboard sleeves.
- Permanent labeling replaces heat transfers and hot stamps.
- Great for photographs and UPC codes.
- Available on blow molded cases and injection mold boxes.

• High resolution graphics for eye-catching packaging

• Conforms to a variety of textures and surfaces

• Can be UV protected

• Eliminates the need for adhesive labels and/or chipboard sleeves

• Permanent labeling replaces heat transfers and hot stamps

• Great for photographs & UPC codes







Pin (PH) or Integral (IH) Hinge Cases

Case Size	Exterior LxW	Routed Opening (GxH)	Routed Depth (R)	Outside Depth (inches)			Inside Depth (inches)			Handles							
				Overall A	Lid B (OL)	Base C (OB)	Overall D	Lid E (IL)	Base F (IB)								
B	IH	7-1/2 x 4	6-13/16 x 3-3/16	1/4	1-1/4	3/8	7/8	15/16	1/8	13/16	None						
					1-5/8	3/8	1-1/4	1-5/16	1/8	1-3/16	None						
	PH	7-1/2 x 4-1/2			1-5/8	3/4	7/8	1-5/16	1/2	13/16	None						
					2	3/4	1-1/4	1-11/16	1/2	1-3/16	None						
					2	1-1/8	7/8	1-11/16	7/8	13/16	None						
					2-3/8	3/4	1-5/8	2-1/16	1/2	1-9/16	None						
					2-3/8	1-1/8	1-1/4	2-1/16	7/8	1-3/16	None						
					2-3/4	3/4	2	2-7/16	1/2	1-15/16	None						
					2-3/4	1-1/8	1-5/8	2-7/16	7/8	1-9/16	None						
					3-1/8	1-1/8	2	2-13/16	7/8	1-15/16	None						
					C	IH	8-1/2 x 7	7-9/16 x 5-7/8	7/16	1-3/4	7/8	7/8	1-7/16	5/8	13/16	None	
										2-1/16	7/8	1-3/16	1-3/4	5/8	1-1/8	None	
					PH	8-1/2 x 7-13/16				2-1/16	1-3/16	7/8	1-3/4	15/16	13/16	None	
										2-3/8	1-3/16	1-3/16	2-1/16	15/16	1-1/8	None	
3-1/8	7/8	2-1/4	2-13/16	5/8						2-3/16	None or 4" Side						
3-7/16	1-3/16	2-1/4	3-1/8	15/16						2-3/16	None or 4" Side						
3-9/16	7/8	2-11/16	3-1/4	5/8						2-5/8	None or 4" Side						
3-7/8	1-3/16	2-11/16	3-9/16	15/16						2-5/8	None or 4" Side						
F	IH	9-1/2 x 5	8-5/8 x 4	7/16						1-3/4	7/8	7/8	1-7/16	5/8	13/16	None	
										2-1/16	7/8	1-3/16	1-3/4	5/8	1-1/8	None	
PH	9-1/2 x 5-3/4									2-1/16	1-3/16	7/8	1-3/4	15/16	13/16	None	
										2-3/8	1-3/16	1-3/16	2-1/16	15/16	1-1/8	None	
					3-1/8	7/8	2-1/4	2-13/16	5/8	2-3/16	None or 4" Side						
					3-7/16	1-3/16	2-1/4	3-1/8	15/16	2-3/16	None or 4" Side						
					3-9/16	7/8	2-11/16	3-1/4	5/8	2-5/8	None or 4" Side						
					3-7/8	1-3/16	2-11/16	3-9/16	15/16	2-5/8	None or 4" Side						
H	IH	10 x 7-1/2	9-1/8 x 6-1/2	7/16	1-3/4	7/8	7/8	1-7/16	5/8	13/16	None						
					2-1/16	7/8	1-3/16	1-3/4	5/8	1-1/8	None						
	PH	10 x 8-5/16				2-1/16	1-3/16	7/8	1-3/4	15/16	13/16	None					
						2-3/8	1-3/16	1-3/16	2-1/16	15/16	1-1/8	None					
						3-1/8	7/8	2-1/4	2-13/16	5/8	2-3/16	None or 4" Side					
						3-7/16	1-3/16	2-1/4	3-1/8	15/16	2-3/16	None or 4" Side					
						3-9/16	7/8	2-11/16	3-1/4	5/8	2-5/8	None or 4" Side					
						3-7/8	1-3/16	2-11/16	3-9/16	15/16	2-5/8	None or 4" Side					
						Q	IH	12-1/4 x 8	11-3/8 x 7	7/16	1-3/4	7/8	7/8	1-7/16	5/8	13/16	None
											2-1/16	7/8	1-3/16	1-3/4	5/8	1-1/8	None
PH	12-1/4 x 8 <sup>3/16</sup>				2-1/16	1-3/16	7/8	1-3/4	15/16	13/16	None						
					2-3/8	1-3/16	1-3/16	2-1/16	15/16	1-1/8	None						
					2-7/16	1-9/16	7/8	2-1/16	1-1/4	13/16	None						
					2-3/4	1-9/16	1-3/16	2-3/8	1-1/4	1-1/8	None						
					3-1/8	7/8	2-1/4	2-13/16	5/8	2-3/16	None or 4" Side						
					3-7/16	1-3/16	2-1/4	3-1/8	15/16	2-3/16	None or 4" Side						
					3-9/16	7/8	2-11/16	3-1/4	5/8	2-5/8	None or 4" Side						
					3-13/16	1-9/16	2-1/4	3-7/16	1-1/4	2-3/16	None or 4" Side						
					3-7/8	1-3/16	2-11/16	3-9/16	15/16	2-5/8	None or 4" Side						
					4-1/4	1-9/16	2-11/16	3-7/8	1-1/4	2-5/8	None or 4" Side						
					V	IH	13-1/2 x 10	12-11/16 x 8-15/16	7/16	2-1/16	7/8	1-3/16	1-3/4	5/8	1-1/8	None or 5" Side	
										2-3/8	1-3/16	1-3/16	2-1/16	15/16	1-1/8	None or 5" Side	
						PH	13-1/2 x 10 <sup>19/16</sup>				3-1/8	7/8	2-1/4	2-13/16	5/8	2-3/16	None or 5" Side
											3-7/16	1-3/16	2-1/4	3-1/8	15/16	2-3/16	None or 5" Side
3-11/16	7/8	2-13/16	3-3/8	5/8							2-3/4	None or 5" Side					
4	1-3/16	2-13/16	3-11/16	15/16							2-3/4	None or 5" Side					
4-1/16	1-13/16	2-1/4	3-11/16	1-1/2							2-3/16	None or 5" Side					
4-1/2	1-3/16	3-5/16	4-3/16	15/16							3-1/4	None or 5" Side					
4-5/8	1-13/16	2-13/16	4-1/4	1-1/2							2-3/4	None or 5" Side					
5-1/8	1-13/16	3-5/16	4-3/4	1-1/2							3-1/4	None or 5" Side					
6-1/8	2-5/16	3-13/16	5-5/8	1-7/8	3-3/4	None or 5" Side											
Case Size	Exterior LxW	Routed Opening (GxH)	Routed Depth (R)	Outside Depth (inches)			Inside Depth (inches)			Base (IB)							
				Overall A	Lid B (OL)	Base C (OB)	Overall D	Lid E (IL)	Base F (IB)								
W	IH	15-1/2 x 12-1/4	14 x 10-3/4	1-1/4	2-1/2	1	1-1/2	2	5/8	1-3/8	1-1/8						
					3-1/4	1	2-1/4	2-3/4	5/8	2-1/8	1-7/8						
	PH	15-1/2 x 13 <sup>3/16</sup>				4	1-3/4	2-1/4	3-1/2	1-3/8	2-1/8	1-7/8					
						4	1	3	3-1/2	5/8	2-7/8	2-5/8					
						4-3/4	2-1/2	2-1/4	4-1/4	2-1/8	2-1/8	1-7/8					
						4-3/4	1-3/4	3	4-1/4	1-3/8	2-7/8	2-5/8					
						5-1/2	2-1/2	3	5	2-1/8	2-7/8	2-5/8					
						5-1/2	1-3/4	3-3/4	5	1-3/8	3-5/8	3-1/4					
						6-1/4	2-1/2	3-3/4	5-3/4	2-1/8	3-5/8	3-1/4					
						6-1/4	3-1/4	3	5-5/8	2-3/4	2-7/8	2-5/8					
						6-3/4	3-3/4	3	6-1/8	3-1/4	2-7/8	2-5/8					
						7	3-1/4	3-3/4	6-3/8	2-3/4	3-5/8	3-1/4					
						7-1/2	3-3/4	3-3/4	6-7/8	3-1/4	3-5/8	3-1/4					

Pin or Integral Hinge Cases

Case Size	Exterior LxW	Routed Opening (GxH)	Routed Depth (R)	Outside Depth (inches)			Inside Depth (inches)			Base	
				Overall A	Lid B (OL)	Base C (OB)	Overall D	Lid E (IL)	Base F (IB)		
X	IH 18-1/2 x 14-1/2	17 x 13	15/16*	3	1-1/4	1-3/4	2-1/2	7/8	1-5/8	1-3/8	
				1-3/4	3	1-3/8	1-5/8	2-3/4			
	PH 18-1/2 x 15-7/16			1-3/4	3-3/4	1-1/4	2-1/2	3-1/4	7/8	2-3/8	2
					4-1/4	1-3/4	2-1/2	3-3/4	1-3/8	2-3/8	2
					4-3/4	2-1/4	2-1/2	4-1/8	1-3/4	2-3/8	2
					5	1-3/4	3-1/4	4-1/2	1-3/8	3-1/8	2-3/4
					5-1/2	2-1/4	3-1/4	4-7/8	1-3/4	3-1/8	2-3/4
					6	2-3/4	3-1/4	5-3/8	2-1/4	3-1/8	2-3/4
					6-1/4	2-1/4	4	5-5/8	1-3/4	3-7/8	3-1/4
					6-1/2	4	2-1/2	5-7/8	3-1/2	2-3/8	2
					6-3/4	2-3/4	4	6-1/8	2-1/4	3-7/8	3-1/4
					7-1/4	4	3-1/4	6-5/8	3-1/2	3-1/8	2-3/4
					8	4	4	7-3/8	3-1/2	3-7/8	3-1/4

Integral Hinge Cases

Case Size	Exterior LxW	Routed Opening (GxH)	Routed Depth (R)	Outside Depth (inches)			Inside Depth (inches)			Handles
				Overall A	Lid B (OL)	Base C (OB)	Overall D	Lid E (IL)	Base F (IB)	
RA	7-1/2 x 5-3/4	6-5/8 x 4-3/4	7/16	1-3/4	7/8	7/8	1-7/16	5/8	13/16	None
				2-1/16	7/8	1-3/16	1-3/4	5/8	1-1/8	None
				2-1/16	1-3/16	7/8	1-3/4	15/16	13/16	None
				2-3/8	1-3/16	1-3/16	2-1/16	15/16	1-1/8	None
				2-5/8	1-3/16	1-7/16	2-5/16	15/16	1-3/8	None
				3-1/8	7/8	2-1/4	2-13/16	5/8	2-3/16	None or 4" Side
				3-7/16	1-3/16	2-1/4	3-1/8	15/16	2-3/16	None or 4" Side
				3-7/8	1-3/16	2-11/16	3-1/4	5/8	2-5/8	4" Top Only
				5	2-5/16	2-11/16	4-5/8	2	2-5/8	None or 4" Side
				RC	8-1/2 x 7	7-9/16 x 5-7/8	7/16	3-7/8	1-3/16	2-11/16
3-7/8	1-3/16	2-11/16	3-1/4					5/8	2-5/8	4" Top Only
5	2-5/16	2-11/16	4-5/8					2	2-5/8	None or 4" Side
1-3/4	7/8	7/8	1-7/16					5/8	13/16	None
2-1/16	7/8	1-3/16	1-3/4					5/8	1-1/8	None
2-1/16	1-3/16	7/8	1-3/4					15/16	13/16	None
2-3/8	1-3/16	1-3/16	2-1/16					15/16	1-1/8	None
3-1/8	7/8	2-1/4	2-13/16					5/8	2-3/16	None or 4" Side
3-7/16	1-3/16	2-1/4	3-1/8					15/16	2-3/16	None or 4" Side
3-9/16	7/8	2-11/16	3-1/4					5/8	2-5/8	None or 4" Side
RH	10 x 7-1/2	9-1/8 x 6-1/2	7/16	3-7/8	1-3/16	2-11/16	3-1/4	5/8	2-5/8	4" Top Only
				3-7/8	1-3/16	2-11/16	3-1/4	5/8	2-5/8	4" Top Only
				5	2-5/16	2-11/16	4-5/8	2	2-5/8	None or 4" Side
				1-3/4	7/8	7/8	1-7/16	5/8	13/16	None
				2-1/16	7/8	1-3/16	1-3/4	5/8	1-1/8	None
				2-1/16	1-3/16	7/8	1-3/4	15/16	13/16	None
				2-3/8	1-3/16	1-3/16	2-1/16	15/16	1-1/8	None
				3-1/8	7/8	2-1/4	2-13/16	5/8	2-3/16	None or 4" Side
				3-7/16	1-3/16	2-1/4	3-1/8	15/16	2-3/16	None or 4" Side
				3-9/16	7/8	2-11/16	3-1/4	5/8	2-5/8	None or 4" Side
RK	11 x 5-1/4	10-1/8 x 4-1/4	7/16	3-7/8	1-3/16	2-11/16	3-9/16	15/16	2-5/8	None or 4" Side
				3-7/8	1-3/16	2-11/16	3-1/4	5/8	2-5/8	4" Top Only
				3-7/8	1-3/16	2-11/16	3-1/4	5/8	2-5/8	4" Top Only
				1-3/4	7/8	7/8	1-7/16	5/8	13/16	None
				2-1/16	7/8	1-3/16	1-3/4	5/8	1-1/8	None
				2-1/16	1-3/16	7/8	1-3/4	15/16	13/16	None
				2-3/8	1-3/16	1-3/16	2-1/16	15/16	1-1/8	None
				3-1/8	7/8	2-1/4	2-13/16	5/8	2-3/16	None or 4" Side
				3-7/16	1-3/16	2-1/4	3-1/8	15/16	2-3/16	None or 4" Side
				3-9/16	7/8	2-11/16	3-1/4	5/8	2-5/8	None or 4" Side
RN	12-1/4 x 6-1/4	11-3/8 x 5-1/4	7/16	3-7/8	1-3/16	2-11/16	3-9/16	15/16	2-5/8	None or 4" Side
				3-7/8	1-3/16	2-11/16	3-1/4	5/8	2-5/8	4" Top Only
				1-3/4	7/8	7/8	1-7/16	5/8	13/16	None
				2-1/16	7/8	1-3/16	1-3/4	5/8	1-1/8	None
				2-1/16	1-3/16	7/8	1-3/4	15/16	13-16	None
				2-3/8	1-3/16	1-3/16	2-1/16	15/16	1-1/8	None
				3-1/8	7/8	2-1/4	2-13/16	5/8	2-3/16	None or 4" Side
				3-7/16	1-3/16	2-1/4	3-1/8	15/16	2-3/16	None or 4" Side
				3-9/16	7/8	2-11/16	3-1/4	5/8	2-5/8	None or 4" Side
				3-7/8	1-3/16	2-11/16	3-9/16	15/16	2-5/8	None or 4" Side
RT	12-1/2 x 4-1/4	11-5/8 x 3-1/4	7/16	3-7/8	1-3/16	2-11/16	3-1/4	5/8	2-5/8	4" Top Only
				3-7/8	1-3/16	2-11/16	3-1/4	5/8	2-5/8	4" Top Only
				1-3/4	7/8	7/8	1-7/16	5/8	13/16	None
				2-1/16	7/8	1-3/16	1-3/4	5/8	1-1/8	None
				2-1/16	1-3/16	7/8	1-3/4	15/16	13/16	None
				2-3/8	1-3/16	1-3/16	2-1/16	15/16	1-1/8	None
				3-1/8	7/8	2-1/4	2-13/16	5/8	2-3/16	None or 4" Side
				3-7/16	1-3/16	2-1/4	3-1/8	15/16	2-3/16	None or 4" Side
				3-9/16	7/8	2-11/16	3-1/4	5/8	2-5/8	None or 4" Side
				3-7/8	1-3/16	2-11/16	3-9/16	15/16	2-5/8	None or 4" Side
RO	12-1/4 x 8	11-3/8 x 7	7/16	3-7/8	1-3/16	2-11/16	3-1/4	5/8	2-5/8	4" Top Only
				3-7/16	1-3/16	2-1/4	2-13/16	5/8	2-13/16	5" Top Only
RV	13-1/2 x 10	12-11/16 x 8-15/16	7/16	4	1-3/16	2-13/16	3-3/8	5/8	2-3/4	5" Top Only
				4-1/2	1-3/16	3-5/16	3-7/8	5/8	3-1/4	5" Top Only

Pin Hinge Cases

Case Size	Exterior LxW	Routed Opening (GxH)	Routed Depth (R)	Outside Depth (inches)			Inside Depth (inches)			Base
				Overall A	Lid B (OL)	Base C (OB)	Overall D	Lid E (IL)	Base F (IB)	
PZ	26 x 15-9/16	24-1/2 x 13	1-1/8	3	1-1/4	1-3/4	2-1/2	7/8	1-5/8	1-3/8
				3-1/2	1-3/4	1-3/4	3	1-3/8	1-5/8	1-3/8
				3-3/4	1-1/4	2-1/2	3-1/4	7/8	2-3/8	2
				4-1/4	1-3/4	2-1/2	3-3/4	1-3/8	2-3/8	2
				4-3/4	2-1/4	2-1/2	4-1/8	1-3/4	2-3/8	2
				5	1-3/4	3-1/4	4-1/2	1-3/8	3-1/8	2-3/4
				5-1/2	2-1/4	3-1/4	4-7/8	1-3/4	3-1/8	2-3/4
				6	2-3/4	3-1/4	5-3/8	2-1/4	3-1/8	2-3/4
				6-1/4	2-1/4	4	5-5/8	1-3/4	3-7/8	3-1/4
				6-1/2	4	2-1/2	5-7/8	3-1/2	2-3/8	2
				6-3/4	2-3/4	4	6-1/8	2-1/4	3-7/8	3-1/4
				7-1/4	4	3-1/4	6-5/8	3-1/2	3-1/8	2-3/4
				8	4	4	7-3/8	3-1/2	3-7/8	3-1/4
				9	4	5	8-3/8	3-1/2	4-7/8	4-1/2



## Additional Styles of Custom Blow Molded Cases Available

Flambeau can also provide you a number of protective case options from our inventory of proprietary molds. Developed for specific applications. These unique cases are available to you "as-is," or can be customized for your specific application. Call our Customer Service Department for more details (1-800-344-5716).



Integral Handle



High Cube Cases



Pallet Cases



Expandable Cases



## Display Windows

Display Windows are an excellent way to merchandise your products. The Windows are manufactured from a clear plastic resin and can be hot stamped with your company name or logo. Two sizes of Windows are available and are custom fitted to our Pin Hinge Style Cases.

Available Sizes:

Small: 5 15/16 x 1 15/16

Large: 8 7/16 x 2 3/16

### Handle and Latch Options

Size	Handle and Notes	Latch (options)	Size	Handle and Notes	Latch (options)
PB	None	L-089 plastic	PW	H-023 or Integral	L-085 plastic L-037 metal
PCH-001	(3.125" and deeper)	L-089 plastic	PX	H-023 or Integral	L-026 metal locking L-085 plastic
PF	H-001 (3.125" and deeper)	L-089 plastic			L-037 metal
PH	H-001 (3.125" and deeper)	L-089 plastic	PZ	H-023 or Integral	L-026 metal locking L-095 plastic
PQ	H-052 (3.125" and deeper)	L-089 plastic			L-032 metal
PV	H-052 (2.062" and deeper)	L-089 plastic			

### Handle and Latch Options

#### HANDLES

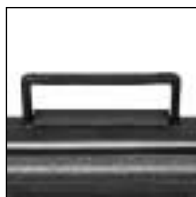

H-001



H-023



H-052



Integral Handle

#### LATCHES



L-026



L-037



L-085



L-089



L-095





**Additional Options**

Option	Additional Tooling Expense	Option	Additional Tooling Expense
Custom small exterior logo plate	Yes	Lid stays (W, X or Z only)	No
Custom large exterior logo plate	Yes	Die cut foam	Yes
Interior door(s)	Yes	Vacuum formed inserts	Yes
Interior tray(s)	Yes	Pallets and/or file folders*	No
Literature holder: routed slot	No	Handles	No
Literature holder: plastic clip	No	Latches	No
Literature holder: elastic strap	No		

\*Only available with certain cases

**Additional Options**



Interior Doors



Vacuum Formed Inserts



Large Custom Logo Plate



Die Cut Foam



Security Feature



Small Custom Logo Plate



Interior Tray and Base



Elastic Strap



Plastic Clip



Hold-Open Hinge



Printed Interior

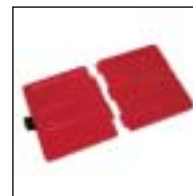

Removable Lid



# Compartmented Boxes

Flambeau has the largest selection of stock compartmented boxes available anywhere. With different stock materials for different uses and environments. We can customize to meet your needs through color and material selection, compartment size and arrangement. In addition, Flambeau can logo imprint, hot-stamp and pad-print. Other resins are available for custom requirements.





## Infinite Divider System™

- The ultimate organizer for compartment storage.
- Ultimate flexibility – you determine divider locations.
- Patented design.
- Ideal for organizing odd length/size items.



## Diamondback™ Styrene Boxes

- Sleek design for improved merchandising.
- Crystal Clear Styrene material – as clear as glass.
- Improved hinge strength and easy open lid.
- Stacking feet for neater displays.
- Applications include:
  - food products
  - electronic parts
  - medical & lab supplies
  - hobby parts
  - office supplies
  - precision parts
  - screws & washers
  - small tools



## Precision Box

- Engineered storage box for small speciality items.
- Molded from sturdy acrylic material; features rust proof hinge pins.
- Resists most common chemicals.
- Available in colors; can be hot stamped.



## Mighty-Tuff™ Boxes

- Made with transparent cellulose propionate.
- Extremely tough and sturdy.
- Incorporates metal hinge.
- Excellent for industrial and institutional environments.



## Polypropylene Boxes

- Extremely durable; molded with heat-sealed hinges.
- Resists solvents such as gasoline, oil and most common chemicals.
- Ideal for organizing and carrying small items.
- Translucent, opaque yellow, or black colors available.



## Textured Integral Hinge Boxes

- Very sturdy, full-length living hinge.
- Snap-lock closure.
- Excellent for autoclave processes.
- Smooth label or imprint area for labeling.



## K-Resin® Boxes

- K-Resin® is a sturdy, transparent material.
- Excellent for heavy-duty applications.
- Good impact resistance.
- Individually packed in chipboard sleeves.





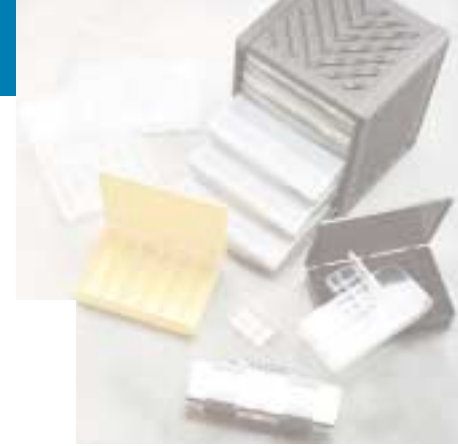

## Infinite Divider System™

The Ultimate Storage Container! Flambeau offers a complete system, Boxes and Cabinet, with "infinite" flexibility! Organize your space the way you need it. You place the dividers where needed. Dividers can be adjusted 1/8" at a time.

- Great for small parts of various sizes.
- Eliminates wasted space caused by fixed dividers.
- Made from durable chemical and solvent resistant polypropylene.
- Patented Design.
- Cabinet can be found on page 26.

### Ordering Information/IDS Boxes

Stock No.	Description	Fits IDS Cabinet	Outside Dimensions	Pk. Per Carton
6715ID	T-300 Box with 6 dividers	no	6-5/8 x 3-3/8 x 1-1/4	12
601316	Extra Dividers for T-300	-	-	-
6719ID	T-600 Box with 6 dividers	yes	11 x 6-3/4 x 1-3/4	6
6719DV	Extra Dividers for T-600	-	-	-
6725ID	T-900 Box with 16 dividers	yes	13-1/2 x 9-1/2 x 2-3/16	6
601310	Extra Dividers for T-900 and 999-2	-	-	-
6726ID	999-2 Box with 16 dividers and handle	yes	13-1/2 x 9-1/2 x 2-3/16	6

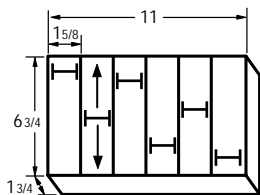

**T600**  
(includes 6 movable dividers)

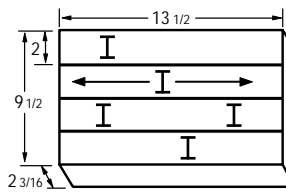

**T900**  
(includes 16 movable dividers for up to 20 compartments)

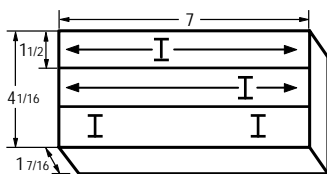

**T300**  
(includes 6 movable dividers)

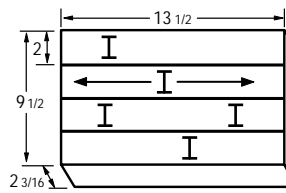

**999-2**  
(includes a handle and 16 movable dividers)



## IDS™ Cabinet

Flambeau's IDS™ Cabinet comes equipped with five T900 box and 16 dividers in each box. The IDS™ Cabinet also accommodates Flambeau's 600 and 800 Series Boxes. The Cabinet is also available as a stand-alone item without boxes. The IDS™ Cabinet features:

- Rust-proof polypropylene.
- Dent-proof, scratch-resistant, textured finish.
- Interlocking stackable feature, ideal for maintenance rooms.
- Custom colors and hot stamping available.
- Applications: Electrical terminals, MRO Areas, fasteners.

### Ordering Information/IDS™ Cabinet

Stock No.	Description	Dimensions	Pk. Per Carton
8500ST	IDS™ Cabinet with 5 trays and 5 T-900 Boxes	14.5 x 15.5 x 15.8	1
8500JT	IDS™ Cabinet with 5 trays and 5 999-2 Boxes	14.5 x 15.5 x 15.8	1
8500NT	IDS™ Cabinet with 5 trays-No Boxes	14.5 x 15.5 x 15.8	1



## T901

The new open core T901 is a single compartment box designed to fit the IDS Cabinet. Manufactured from translucent polypropylene the new T901 is ideal for creating custom kits using vacuum formed trays or custom foam sets. Custom colors and hot stamping are also available.

### Ordering Information T901

Stock No.	Description	Dimensions	Pk. Per Carton
6727ID	T901	13-1/2 x 9-1/2 x 2-3/16	6





## Tuff-Tainers

Tuff-Tainers from Flambeau extend the compartmented box concept to include eight additional box sizes for organizing and protecting parts and components. Tuff-Tainers are made to resist most common chemicals and include snap latches, a detachable lid, and the ability to configure your own compartments. These boxes are ideal for hot stamping with your logo.

(Note: Tuff-Tainers do not fit the IDS™ Cabinet.)

### Ordering Information

Stock No.	Description	Dimensions	Pk. Per Carton
6709TE	T1002 Box with 6 compartments and 4 dividers	4-5/8 x 3-3/8 x 1-1/4	12
6703TE	T2003 Box with 3 compartments and 15 dividers	7 x 3-1/2 x 1-7/16	12
601321	Extra dividers for T2003		
6707TE	T3003 Box with 3 compartments and 15 dividers	9 x 4-1/2 x 1-5/16	12
601320	Extra dividers for T3003		
6716TE	T4006 Box with 6 compartments and 12 dividers	10-3/4 x 6-7/8 x 1-3/4	6
601319	Extra dividers for T4006		
6728TE	T5004 Box with 4 compartments and 20 dividers	14 x 8-1/2 x 1-7/8	6
601318	Extra dividers for T5004		
6760TE	T6004 Box with 4 compartments and 16 dividers	15-11/16 x 8-1/2 x 1-1/2	6
6770TE	T7000 Box One Compartment	15-1/2 x 9-1/4 x 3-1/8	6
6774TE	T7004 Box with 15 compartments and 15 dividers	15-1/2 x 9-1/4 x 3-1/8	6





## How to Locate the Box You Need

Pages 29 through 41 display the majority of compartmented boxes available from Flambeau. In fact, most of the boxes in the following tables are available from stock. Check with Customer Service (1-800-344-5716) before placing your order.

To find the box you need:

1. Determine the number of compartments required for your needs. (Boxes on pages 29-41 are listed by number of compartments.) Turn to the appropriate page.
2. Select the material best suited for your application.
3. Go to the Model Number Table beginning on page 29. Flambeau's model numbers identifying the box and resin composition generally available from inventory are listed.
4. Choose the desired model number for your needs. Call 1-800-344-5716 to place your order or to get assistance with a custom requirement.

Model	Natural Appearance	Impact Resistance	Durability	Solvent Resistance
Styrene	Clear	Average	Average	Average
Diamondback™	Crystal Clear	Average	Average	Average
K-Resin®	Transparent	Excellent	Good	Average
Translucent Polypropylene	Translucent	Good	Good	Good
Yellow Polypropylene	Translucent	Good	Good	Good
Sand Color Polypropylene	Translucent	Good	Good	Good
Mighty-Tuff	Transparent	Excellent	Excellent	Excellent
Precision	Transparent	Excellent	Excellent	Good





# Inside Dimensions

1 Compartment (see chart on next page)

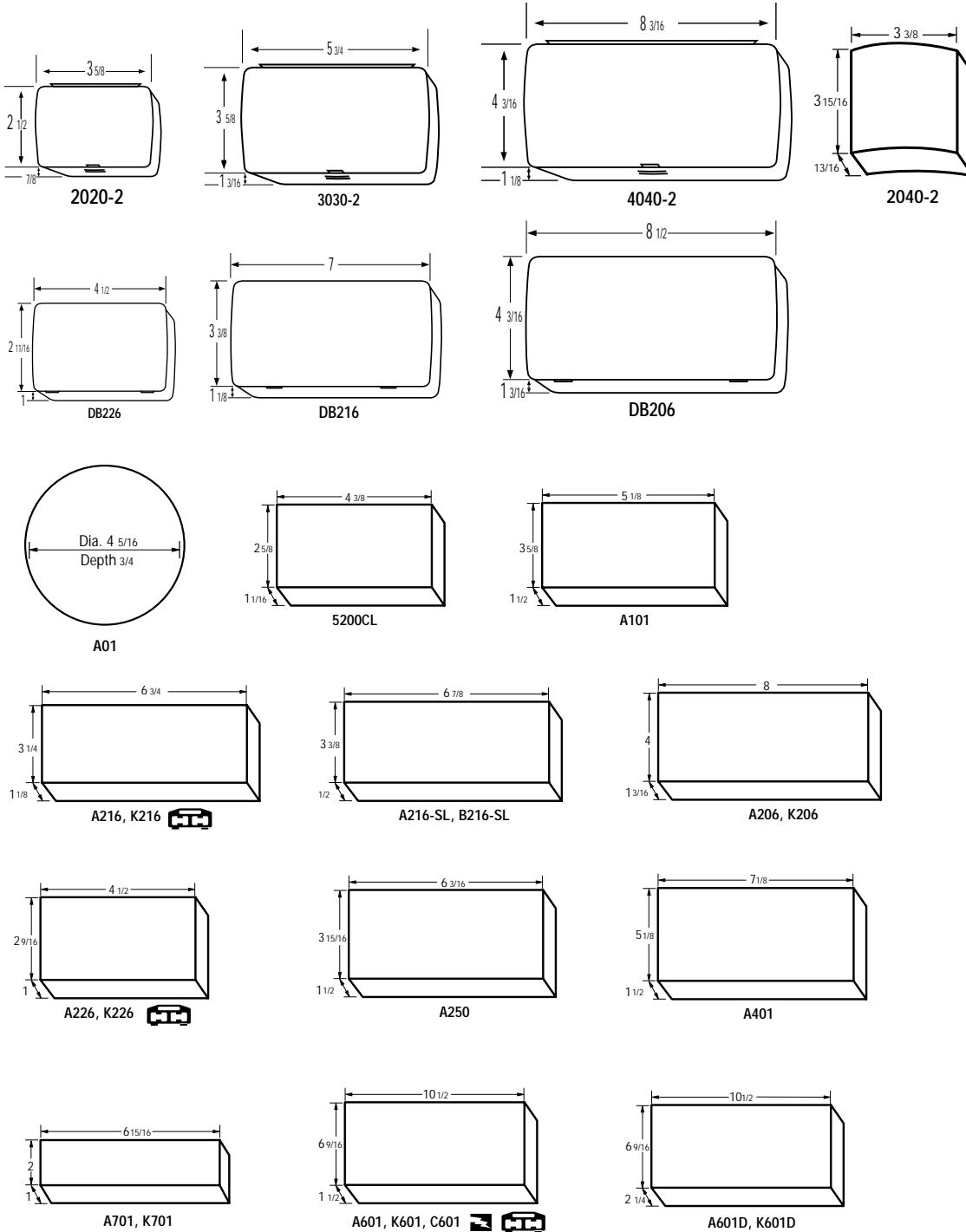



# Inside Dimensions

## 1 Compartment (continued)

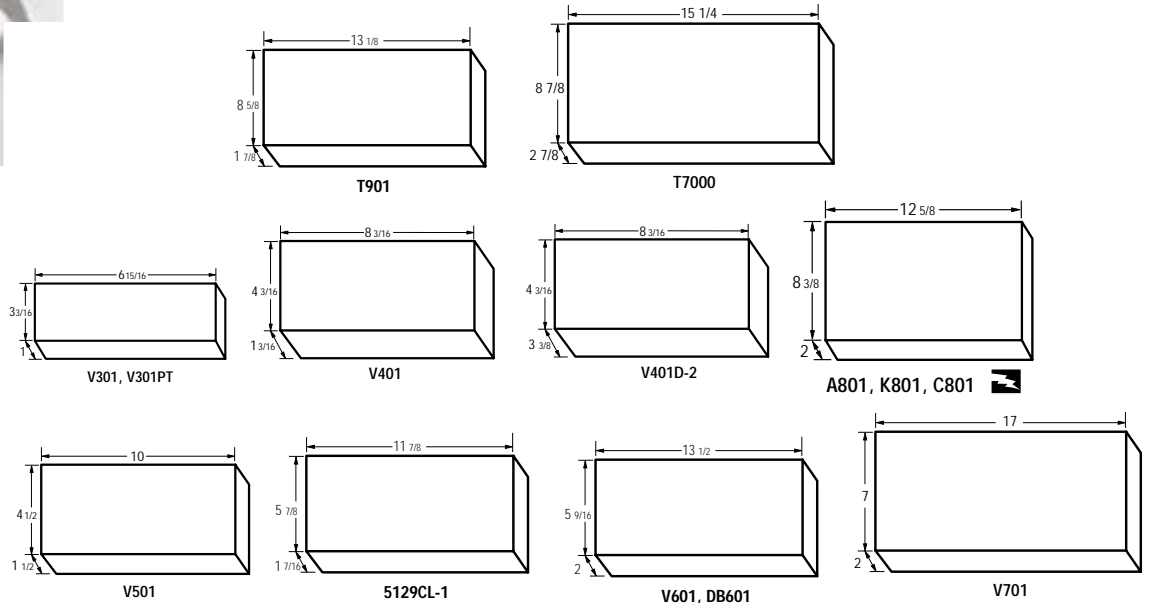

Outside Dimensions			Inside Dimensions			MODEL NUMBER TABLE								Std. Pkg Pkg	Wt (lbs.)
L	W	H	L	W	H	Styrene	Diamondback™	K-Resin®	Translucent Polyprop.	Yellow Polyprop.	Sand Polyprop.	Mighty Tuff™	Precision		
3-7/8	2-3/4	1-1/8	3-5/8	2-1/2	7/8	-	-	-	-	-	-	-	2020-2	24	3.50
3-1/2	4-1/4	1-1/4	3-3/8	3-15/16	13/16	-	-	-	2040-2	-	-	-	-	36	3.81
4-1/2	RND	7/8	4-5/16	RND	3/4	A01	-	-	-	-	-	-	-	80	8.00
4-5/8	3	1-1/8	4-1/2	2-9/16	1	A226	-	K226	-	-	-	-	-	36	5.31
4-7/8	3-5/16	1-3/16	4-1/2	2-11/16	1	-	DB226	-	-	-	-	-	-	48	7.08
4-5/8	3	1-1/4	4-3/8	2-5/8	1-1/16	-	-	-	-	-	-	5200CL	-	12	1.86
5-5/16	4	1-7/8	5-1/8	3-5/8	1-1/2	A101	-	-	-	-	-	-	-	36	8.31
5-7/8	3-7/8	1-3/8	5-3/4	3-5/8	1-3/16	-	-	-	-	-	-	-	3030-2	24	9.25
6-1/4	4	1-11/16	6-3/16	3-15/16	1-1/2	A250	-	-	-	-	-	-	-	36	9.69
7	3-3/4	1-1/4	6-3/4	3-1/4	1-1/8	A216	-	K216	-	-	-	-	-	36	8.87
7-1/4	3-1/2	1-1/8	6-15/16	3-3/16	1	-	-	-	-	-	V301	-	-	36	6.00
7-1/4	3-1/2	1-1/8	6-15/16	3-3/16	1	-	-	-	-	-	V301PT	-	-	36	6.19
7-1/4	3-3/4	3/4	6-7/8	3-3/8	1/2	A216-SL	-	-	B216-SL	-	-	-	-	36	10.32
7-5/16	2-1/2	1-1/4	6-15/16	2	1	A701	-	K701	-	-	-	-	-	36	7.00
7-3/8	4	1-5/16	7	3-3/8	1-1/8	-	DB216	-	-	-	-	-	-	50	12.38
7-5/16	5-9/16	1-7/8	7-1/8	5-1/8	1-1/2	A401	-	-	-	-	-	-	-	36	15.70
8-1/4	4-1/2	1-3/8	8	4	1-3/16	A206	-	K206	-	-	-	-	-	24	8.25
8-3/8	4-1/2	1-11/16	8-3/16	4-3/16	1-3/16	-	-	-	-	-	V401	-	-	24	8.62
8-3/8	4-1/2	1-1/2	8-3/16	4-3/16	1-1/8	-	-	-	-	-	-	-	4040-2	24	10.44
8-3/8	4-1/2	3-1/2	8-3/16	4-3/16	3-3/8	-	-	-	-	-	V401D-2	-	-	24	11.00
8-7/8	4-7/8	1-3/8	8-1/2	4-3/16	1-3/16	-	DB206	-	-	-	-	-	-	48	21.00
10-3/8	4-5/8	1-11/16	10	4-1/2	1-1/2	-	-	-	-	-	V501	-	-	24	9.87
11	6-3/4	1-3/4	10-1/2	6-9/16	1-1/2	A601	DB601	K601	-	-	-	-	-	24	24.12
11	6-3/4	2-1/2	10-1/2	6-9/16	2-1/4	A601D	-	K601D	-	-	-	-	-	24	25.40
12-1/4	6-1/8	1-1/2	11-7/8	5-7/8	1-7/16	-	-	-	-	-	-	-	5129CL-1	6	6.40
13-1/8	9	2-5/16	12-5/8	8-3/8	2	A801	-	K801	-	-	-	-	-	12	20.00
13-1/2	9-1/2	2-3/16	13-1/8	8-5/8	1-7/8	-	-	-	T901	-	-	-	-	6	7.1
14	6-1/4	2-1/2	13-1/2	5-9/16	2	-	-	-	-	-	V601	-	-	12	11.75
15-1/2	9-1/4	3-1/8	15-1/4	8-7/8	2-7/8	-	-	-	T7000	-	-	-	-	6	8.2
17-1/2	7-3/4	2-3/8	17	7	2	-	-	-	-	-	V701	-	-	6	9.31



# Inside Dimensions

## 2 Compartments

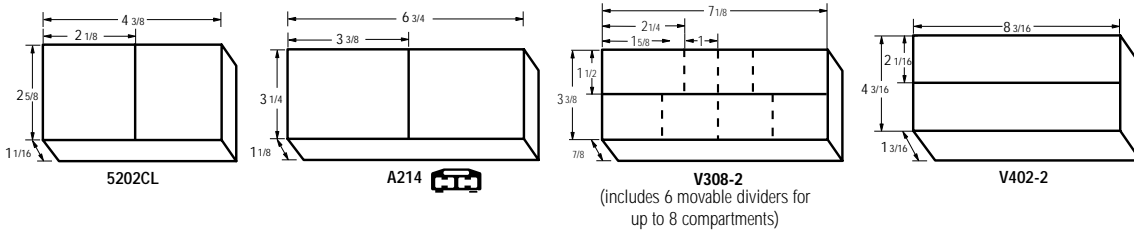

Outside Dimensions			Inside Dimensions			MODEL NUMBER TABLE								Std. Pkg	Pkg Wt (lbs.)
L	W	H	L	W	H	Styrene	Diamondback™	K-Resin®	Translucent Polyprop.	Yellow Polyprop.	Sand Polyprop.	Mighty-Tuff™	Precision		
4-5/8	3	1-1/4	4-3/8	2-5/8	1-1/16	-	-	-	-	-	-	5202CL	-	12	2.00
7	3-3/4	1-1/4	6-3/4	3-1/4	1-1/8	A214	-	-	-	-	-	-	-	36	9.00
7-1/4	3-1/2	1-1/8	7-1/8	3-3/8	7/8	-	-	-	-	-	V308-2	-	-	36	8.50
8-3/8	4-1/2	1-11/16	8-3/16	4-3/16	1-3/16	-	-	-	-	-	V402-2	-	-	24	9.00

## 3 Compartments

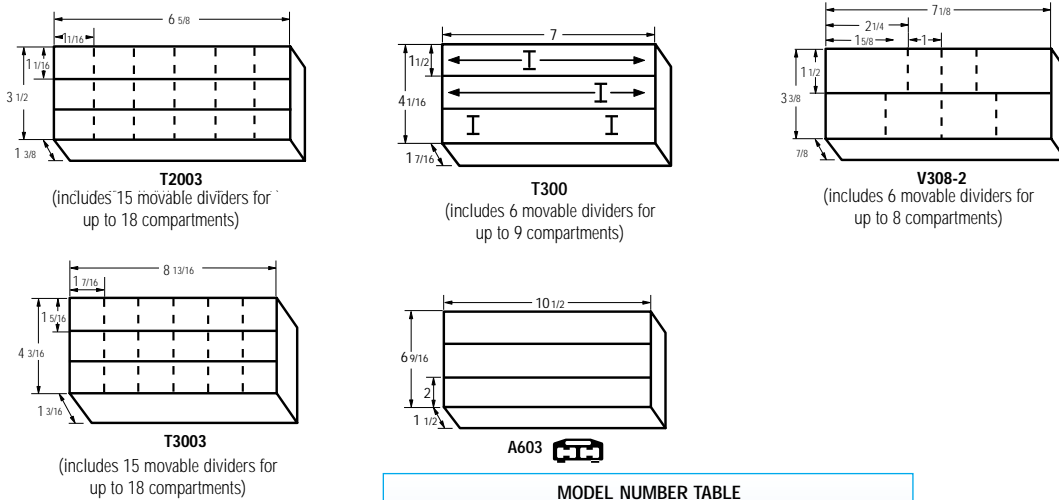

Outside Dimensions			Inside Dimensions			MODEL NUMBER TABLE								Std. Pkg	Pkg Wt (lbs.)
L	W	H	L	W	H	Styrene	Diamondback™	K-Resin®	Translucent Polyprop.	Yellow Polyprop.	Sand Polyprop.	Mighty-Tuff™	Precision		
7	3-5/8	1-1/2	7	8-1/2	1-1/8	-	-	-	T2003	-	-	-	-	12	3.13
7	4-1/16	1-7/16	6-5/8	3-7/8	1-1/4	-	-	-	T300	-	-	-	-	6	2.31
7-1/4	3-1/2	1-1/8	7-1/8	3-3/8	7/8	-	-	-	-	-	V308-2	-	-	36	8.50
9-1/8	4-15/16	1-3/8	8-13/16	4-3/16	1-3/16	-	-	-	T3003	-	-	-	-	12	4.11
11	6-3/4	1-3/4	10-1/2	6-9/16	1-1/2	A603	-	-	-	-	-	-	-	24	25.88



# Inside Dimensions

## 4 Compartments

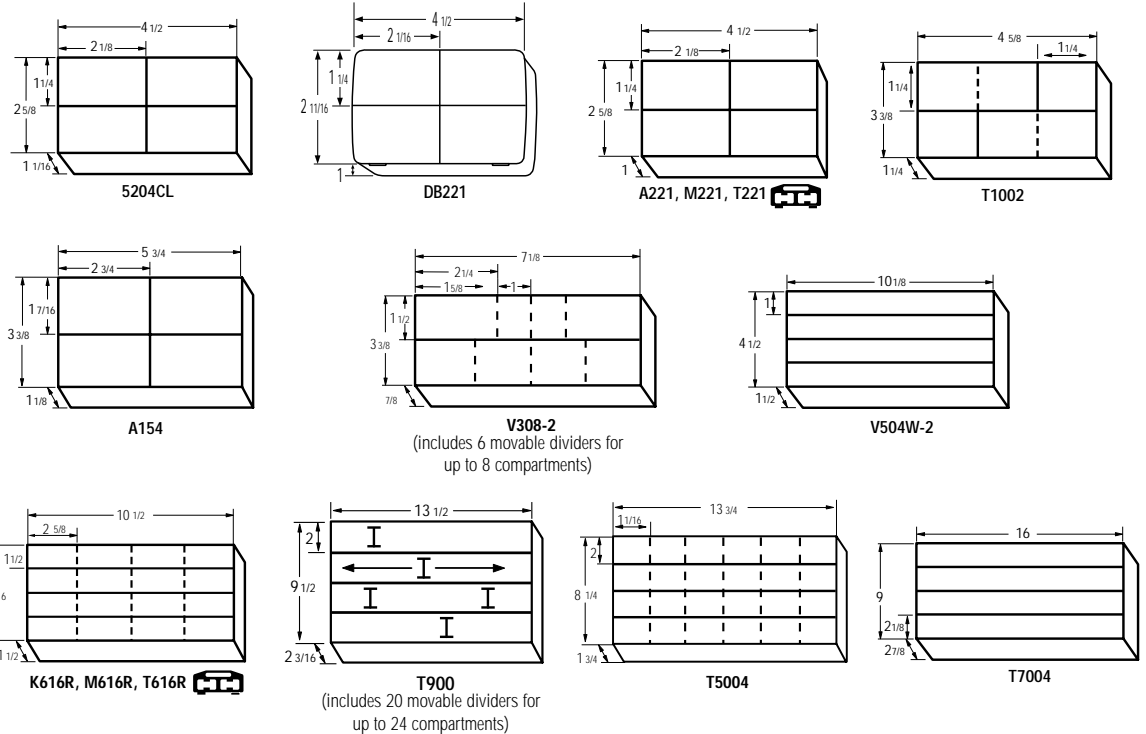

Outside Dimensions		Inside Dimensions			MODEL NUMBER TABLE								Std. Pkg	Pkg Wt (lbs.)	
L	W	H	L	W	H	Styrene	Diamondback™	K-Resin®	Translucent Polyprop.	Yellow Polyprop.	Sand Polyprop.	Mighty Tuft™			Precision
4-5/8	3	1-1/8	4-1/2	2-5/8	1	A221	-	-	T221	M221	-	-	-	36	5.81
4-7/8	3-5/16	1-3/16	4-1/2	2-11/16	1	-	DB221	-	-	-	-	-	-	48	7.75
4-5/8	3	1-1/4	4-1/2	2-5/8	1-1/16	-	-	-	-	-	-	5204CL	-	12	2.13
4-5/8	3-3/8	1-1/4	4-1/4	2-5/8	1-1/8	-	-	-	T1002	-	-	-	-	12	1.8
5-7/8	3-1/2	1-5/16	5-3/4	3-3/8	1-1/8	A154	-	-	-	-	-	-	-	36	8.56
7	4	1-1/2	6-5/8	3-3/8	1-5/16	-	-	-	T2003	-	-	-	-	12	3.13
7	4-1/16	1-7/16	6-5/8	3-7/8	1-1/4	-	-	-	T300	-	-	-	-	6	2.31
7-1/4	3-1/2	1-1/8	7-1/8	3-3/8	7/8	-	-	-	-	-	V308-2	-	-	36	8.50
9-1/8	4-15/16	1-3/8	8-13/16	4-3/16	1-3/16	-	-	-	T3003	-	-	-	-	12	4.11
10-3/8	4-5/8	1-11/16	10-1/8	4-1/2	1-1/2	-	-	-	-	-	V504W-2	-	-	24	12.00
11	6-3/4	1-3/4	10-1/2	6-9/16	1-1/2	-	-	K616R	T616R	M616R	-	-	-	24	25.40
13-1/2	9-1/2	2-3/16	13-1/8	8-5/8	1-7/8	-	-	-	T900	-	-	-	-	6	10.62
14-1/8	9	2	13-3/4	8-1/4	1-3/4	-	-	-	T5004	-	-	-	-	6	7.10
16-1/2	9-3/4	3-1/4	16	9	2-7/8	-	-	-	T7004	-	-	-	-	6	10





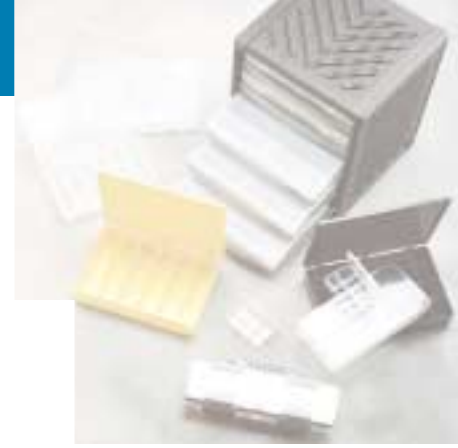

# Inside Dimensions

## 5 Compartments

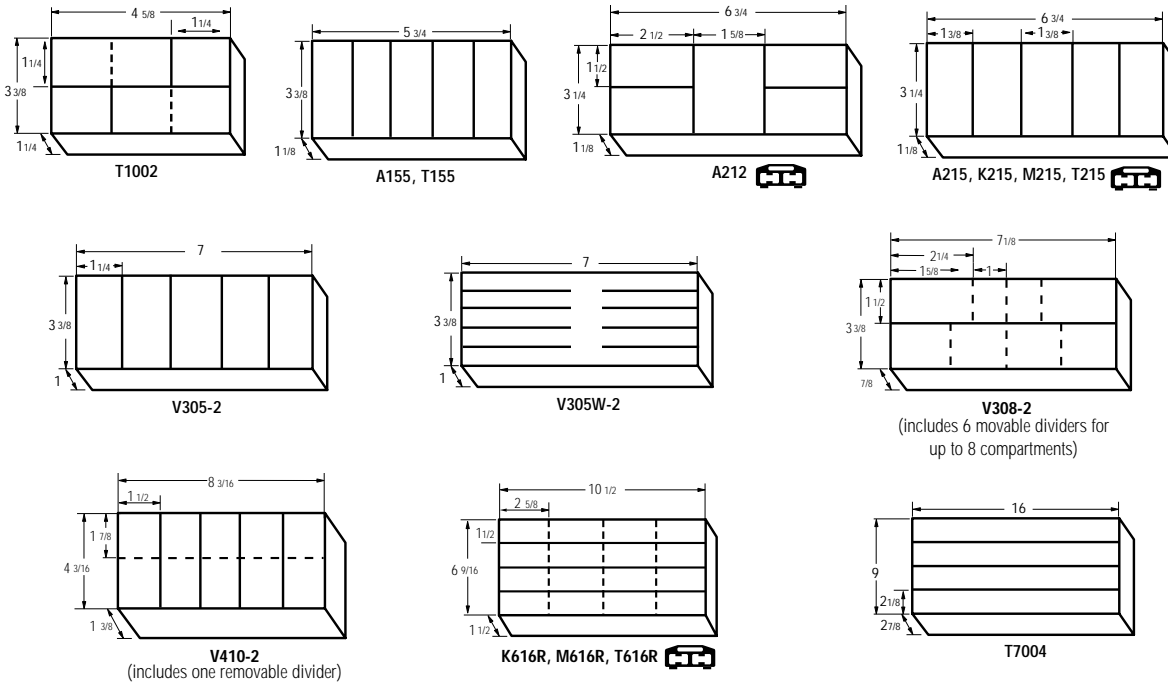

Outside Dimensions		Inside Dimensions			MODEL NUMBER TABLE									Std. Pkg	Pkg Wt (lbs.)
L	W	H	L	W	H	Styrene	Diamondback™	K-Resin®	Translucent Polyprop.	Yellow Polyprop.	Sand Polyprop.	Mighty Turf™	Precision		
4-5/8	3-3/8	1-1/4	4-1/4	2-5/8	1-1/8	-	-	-	T1002	-	-	-	-	12	1.8
5-7/8	3-1/2	1-5/16	5-3/4	3-3/8	1-1/8	A155	-	-	T155	-	-	-	-	36	8.68
7	3-3/4	1-1/4	6-3/4	3-1/4	1-1/8	A212	-	-	-	-	-	-	-	36	9.44
7	3-3/4	1-1/4	6-3/4	3-1/4	1-1/8	A215	-	K215	T215	M215	-	-	-	36	11.00
7	4	1-1/2	6-5/8	3-3/8	1-5/16	-	-	-	T2003	-	-	-	-	12	3.13
7	4-1/16	1-7/16	6-5/8	3-7/8	1-1/4	-	-	-	T300	-	-	-	-	6	2.31
7-1/4	3-1/2	1-1/8	7	3-3/8	1	-	-	-	-	-	V305-2	-	-	36	8.40
7-1/4	3-1/2	1-1/8	7	3-3/8	1	-	-	-	-	-	V305W-2	-	-	36	7.75
7-1/4	3-1/2	1-1/8	7-1/8	3-3/8	7/8	-	-	-	-	-	V308-2	-	-	36	8.50
8-3/8	4-1/2	1-11/16	8-3/16	4-3/16	1-3/8	-	-	-	-	-	V410-2	-	-	24	10.00
9-1/8	4-15/16	1-3/8	8-13/16	4-3/16	1-3/16	-	-	-	T3003	-	-	-	-	12	4.11
11	6-3/4	1-3/4	10-1/2	6-9/16	1-1/2	-	-	K616R	T616R	M616R	-	-	-	24	25.40
13-1/2	9-1/2	2-3/16	13-1/8	8-5/8	1-7/8	-	-	-	T900	-	-	-	-	6	10.62
14-1/8	9	2	13-3/4	8-1/4	1-3/4	-	-	-	T5004	-	-	-	-	6	7.10
16-1/2	9-3/4	3-1/4	16	9	2-7/8	-	-	-	T7004	-	-	-	-	6	10

# Inside Dimensions

## 6 Compartments

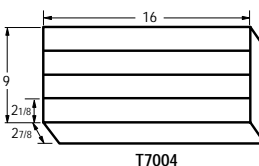
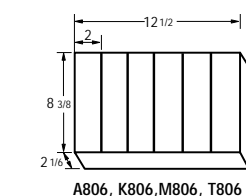
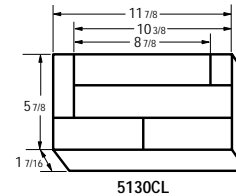
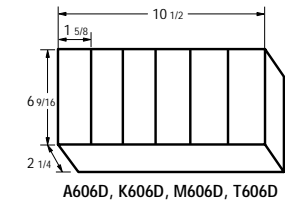
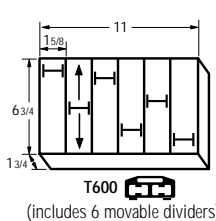
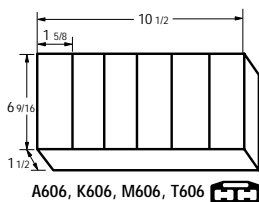
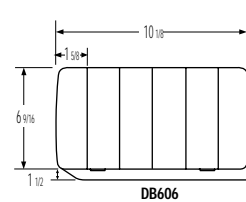
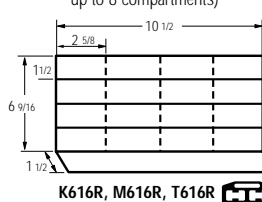
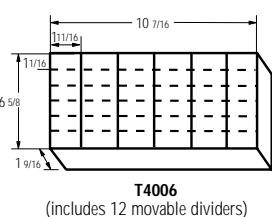
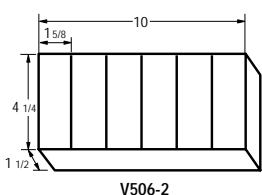
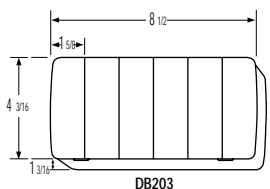
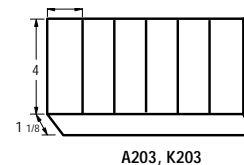
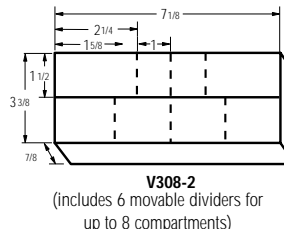
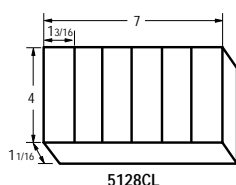
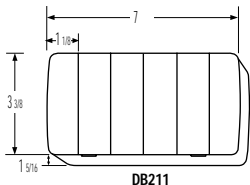
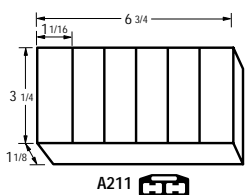
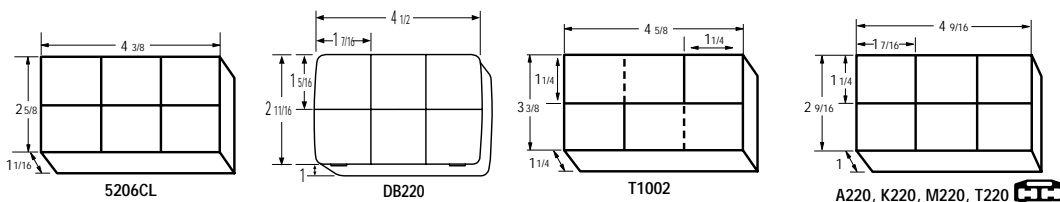

Outside Dimensions		Inside Dimensions			MODEL NUMBER TABLE								Std. Pkg	Pkg Wt (lbs.)	
L	W	H	L	W	H	Styrene	Diamondback™	K-Resin®	Translucent Polyprop.	Yellow Polyprop.	Sand Polyprop.	Mighty-Tuff™			Precision
4-5/8	3	1-1/8	4-9/16	2-9/16	1	A220	-	K220	T220	M220	-	-	-	36	5.90
4-5/8	3	1-1/4	4-3/8	2-5/8	1-1/16	-	-	-	-	-	-	-	5206CL	12	2.32
4-5/8	3-3/8	1-1/4	4-1/4	2-5/8	1-1/8	-	-	-	T1002	-	-	-	-	12	1.8
4-7/8	3-5/16	1-3/16	4-1/2	2-11/16	1	-	DB220	-	-	-	-	-	-	48	5.9
7	3-3/4	1-1/4	6-3/4	3-1/4	1-1/8	A211	-	-	-	-	-	-	-	36	10.25
7	4	1-1/2	6-5/8	3-3/8	1-5/16	-	-	-	T2003	-	-	-	-	12	3.13
7	4-1/16	1-7/16	6-5/8	3-7/8	1-1/4	-	-	-	T300	-	-	-	-	6	2.31
7-1/4	3-1/2	1-1/8	7-1/8	3-3/8	7/8	-	-	-	-	-	V308-2	-	-	36	8.50
7-1/4	4-1/2	1-1/4	7	4	1-1/16	-	-	-	-	-	-	-	5128CL	12	4.69
7-3/8	4	1-5/16	7	3-3/8	1-1/8	-	DB211	-	-	-	-	-	-	50	12.38
8-1/4	4-1/2	1-3/8	8	4	1-3/16	A203	-	K203	T203	M203	-	-	-	24	10.31
8-7/8	4-7/8	1-3/8	8-1/2	4-3/16	1-3/16	-	DB203	-	-	-	-	-	-	48	18.50
9-1/8	4-15/16	1-3/8	8-13/16	4-3/16	1-3/16	-	-	-	T3003	-	-	-	-	12	4.11
10-3/8	4-5/8	1-11/16	10	4-1/4	1-1/2	-	-	-	-	-	V506-2	-	-	24	12.00
11	6-3/4	1-3/4	10-3/8	6-1/8	1-5/8	-	-	-	T600	-	-	-	-	6	6.00
10-7/8	7-3/8	1-3/4	10-7/16	6-5/8	1-9/16	-	-	-	T4006	-	-	-	-	6	5.10
11	6-3/4	1-3/4	10-1/2	6-9/16	1-1/2	A606	DB606	K606	T606	M606	-	-	-	24	25.62
11	6-3/4	1-3/4	10-1/2	6-9/16	1-1/2	-	-	K616R	T616R	M616R	-	-	-	24	25.40
11	6-3/4	2-1/2	10-1/2	6-9/16	2-1/4	A606D	-	K606D	T606D	M606D	-	-	-	24	25.70
12-1/4	6-1/8	1-1/2	11-7/8	5-7/8	1-7/16	-	-	-	-	-	-	-	5130CL	6	5.62
13-1/8	9	2-5/16	12-1/2	8-3/8	2-1/16	A806	-	K806	T806	M806	-	-	-	12	22.00
13-1/2	9-1/2	2-3/16	13-1/8	8-5/8	1-7/8	-	-	-	T900	-	-	-	-	6	10.62
14-1/8	9	2	13-3/4	8-1/4	1-3/4	-	-	-	T5004	-	-	-	-	6	7.10
16-1/2	9-3/4	3-1/4	16	9	2-7/8	-	-	-	T7004	-	-	-	-	6	10



# Inside Dimensions

## 7 Compartments

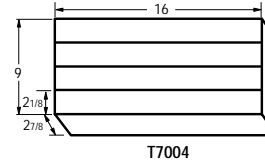
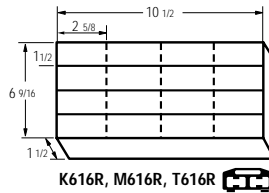
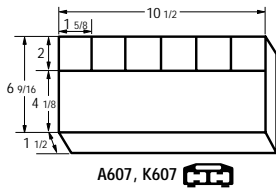
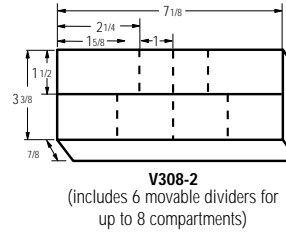
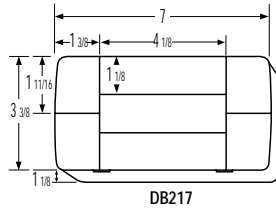
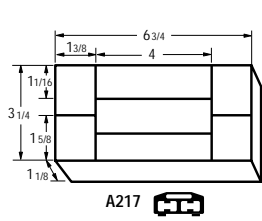

MODEL NUMBER TABLE

Outside Dimensions			Inside Dimensions			MODEL NUMBER TABLE								Std. Pkg	Pkg Wt (lbs.)
L	W	H	L	W	H	Styrene	Diamondback™	K-Resin®	Translucent Polyprop.	Yellow Polyprop.	Sand Polyprop.	Mighty-Tuff™	Precision		
7	4	1-1/2	6-5/8	3-3/8	1-5/16	-	-	-	T2003	-	-	-	-	12	3.13
7	4-1/16	1-7/16	6-5/8	3-7/8	1-1/4	-	-	-	T300	-	-	-	-	6	2.31
7	3-3/4	1-1/4	6-3/4	3-1/4	1-1/8	A217	-	-	-	-	-	-	-	36	10.00
7-1/4	3-1/2	1-1/8	7-1/8	3-3/8	7/8	-	-	-	-	V308-2	-	-	-	36	8.50
7-3/8	4	1-5/16	7	3-3/8	1-1/8	-	DB217	-	-	-	-	-	-	50	15.06
9-1/8	4-15/16	1-3/8	8-13/16	4-3/16	1-3/16	-	-	-	T3003	-	-	-	-	12	4.11
11	6-3/4	1-3/4	10-3/8	6-1/8	1-5/8	-	-	-	T600	-	-	-	-	6	6.00
10-7/8	7-3/8	1-3/4	10-7/16	6-5/8	1-9/16	-	-	-	T4006	-	-	-	-	6	5.10
11	6-3/4	1-3/4	10-1/2	6-9/16	1-1/2	A607	-	K607	-	-	-	-	-	24	25.50
11	6-3/4	1-3/4	10-1/2	6-9/16	1-1/2	-	-	K616R	T616R	M616R	-	-	-	24	25.40
13-1/2	9-1/2	2-3/16	13-1/8	8-5/8	1-7/8	-	-	-	T900	-	-	-	-	6	10.62
14-1/8	9	2	13-3/4	8-1/4	1-3/4	-	-	-	T5004	-	-	-	-	6	7.10
16-1/2	9-3/4	3-1/4	16	9	2-7/8	-	-	-	T7004	-	-	-	-	6	10



# Inside Dimensions

## 8 Compartments

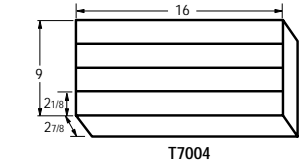
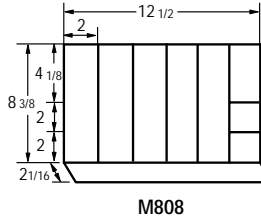
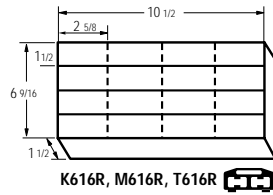
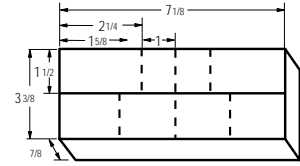
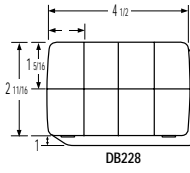
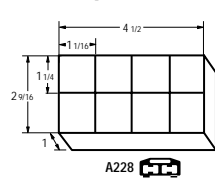

Outside Dimensions		Inside Dimensions			MODEL NUMBER TABLE								Std. Pkg	Pkg Wt (lbs.)	
L	W	H	L	W	H	Styrene	Diamondback™	K-Resin®	Translucent Polyprop.	Yellow Polyprop.	Sand Polyprop.	Mighty-Tuff™			Precision
4-5/8	3	1-1/8	4-1/2	2-9/16	1	A228	-	-	-	-	-	-	-	36	6.00
4-7/8	3-5/16	1-3/16	4-1/2	2-11/16	1	-	DB228	-	-	-	-	-	-	48	6.00
7	4	1-1/2	6-5/8	3-3/8	1-5/16	-	-	-	T2003	-	-	-	-	12	3.13
7	4-1/16	1-7/16	6-5/8	3-7/8	1-1/4	-	-	-	T300	-	-	-	-	6	2.31
7-1/4	3-1/2	1-1/8	7-1/8	3-3/8	7/8	-	-	-	-	-	V308-2	-	-	36	8.50
9-1/8	4-15/16	1-3/8	8-13/16	4-3/16	1-3/16	-	-	-	T3003	-	-	-	-	12	4.11
10-7/8	6-5/16	1-13/16	10-3/8	6-1/8	1-5/8	-	-	-	T600	-	-	-	-	6	6.00
10-7/8	7-3/8	1-3/4	10-7/16	6-5/8	1-9/16	-	-	-	T4006	-	-	-	-	6	5.10
11	6-3/4	1-3/4	10-1/2	6-9/16	1-1/2	-	-	K616R	T616R	M616R	-	-	-	24	25.40
13-1/8	9	2-5/16	12-1/2	8-3/8	2-1/16	-	-	-	-	M808	-	-	-	5	5.31
13-1/2	9-1/2	2-3/16	13-1/8	8-5/8	1-7/8	-	-	-	T900	-	-	-	-	6	10.62
14-1/8	9	2	13-3/4	8-1/4	1-3/4	-	-	-	T5004	-	-	-	-	6	7.10
16-1/2	9-3/4	3-1/4	16	9	2-7/8	-	-	-	T7004	-	-	-	-	6	10

## 9 Compartments

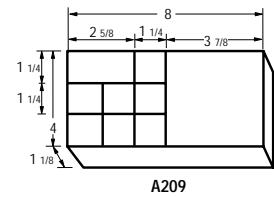
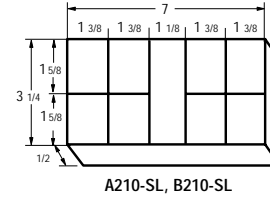
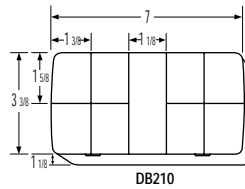
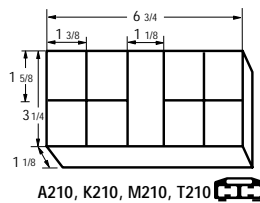

Outside Dimensions		Inside Dimensions			MODEL NUMBER TABLE								Std. Pkg	Pkg Wt (lbs.)	
L	W	H	L	W	H	Styrene	Diamondback™	K-Resin®	Translucent Polyprop.	Yellow Polyprop.	Sand Polyprop.	Mighty-Tuff™			Precision
7	3-3/4	1-1/4	6-3/4	3-1/4	1-1/8	A210	-	K210	T210	M210	-	-	-	36	11.44
7	4	1-1/2	6-5/8	3-3/8	1-5/16	-	-	-	T2003	-	-	-	-	12	3.13
7	4-1/16	1-7/16	6-5/8	3-7/8	1-1/4	-	-	-	T300	-	-	-	-	6	2.31
7-1/4	3-3/4	3/4	7	3-1/4	1/2	A210-SL	-	-	B210-SL	-	-	-	-	36	9.25
7-3/8	4	1-5/16	7	3-3/8	1-1/8	-	DB210	-	-	-	-	-	-	50	15.32
8-1/4	4-1/2	1-3/8	8	4	1-1/8	A209	-	-	-	-	-	-	-	24	9.56
9-1/8	4-15/16	1-3/8	8-13/16	4-3/16	1-3/16	-	-	-	T3003	-	-	-	-	12	4.11
11	6-3/4	1-3/4	10-3/8	6-1/8	1-5/8	-	-	-	T600	-	-	-	-	6	6.00
10-7/8	7-3/8	1-3/4	10-7/16	6-5/8	1-9/16	-	-	-	T4006	-	-	-	-	6	5.10
11	6-3/4	1-3/4	10-1/2	6-9/16	1-1/2	-	-	K616R	T616R	M616R	-	-	-	24	25.40
13-1/2	9-1/2	2-3/16	13-1/8	8-5/8	1-7/8	-	-	-	T900	-	-	-	-	6	10.62
14-1/8	9	2	13-3/4	8-1/4	1-3/4	-	-	-	T5004	-	-	-	-	6	7.10
16-1/2	9-3/4	3-1/4	16	9	2-7/8	-	-	-	T7004	-	-	-	-	6	10

# Inside Dimensions

## 10 Compartments

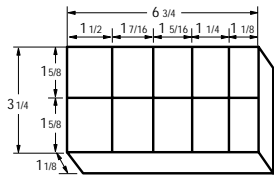

A213

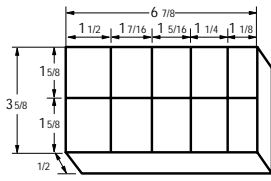

A213-SL

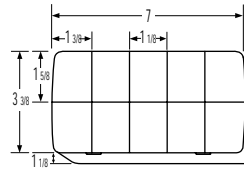

DB213

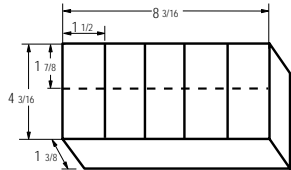

V410-2  
(includes one removable divider)

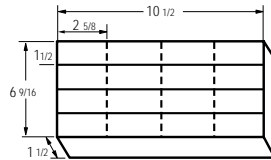

K616R, M616R, T616R

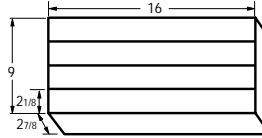

T7004



MODEL NUMBER TABLE								Std. Pkg	Pkg Wt (lbs.)
Styrene	Diamondback™	K-Resin®	Translucent Polyprop.	Yellow Polyprop.	Sand Polyprop.	Mighty-Tuff™	Precision		

Outside Dimensions			Inside Dimensions			MODEL NUMBER TABLE								Std. Pkg	Pkg Wt (lbs.)
L	W	H	L	W	H	Styrene	Diamondback™	K-Resin®	Translucent Polyprop.	Yellow Polyprop.	Sand Polyprop.	Mighty-Tuff™	Precision		
7	4	1-1/2	6-5/8	3-3/8	1-5/16	-	-	-	T2003	-	-	-	-	12	3.13
7	3-3/4	1-1/4	6-3/4	3-1/4	1-1/8	A213	-	-	-	-	-	-	-	36	11.56
7-1/4	3-3/4	3/4	6-7/8	3-5/8	1/2	A213-SL	-	-	-	-	-	-	-	36	10.25
7-3/8	4	1-5/16	7	3-3/8	1-1/8	-	DB213	-	-	-	-	-	-	50	15.75
8-3/8	4-1/2	1-11/16	8-3/16	4-3/16	1-3/8	-	-	-	-	V410-2	-	-	-	24	10.00
9-1/8	4-15/16	1-3/8	8-13/16	4-3/16	1-3/16	-	-	-	T3003	-	-	-	-	12	4.11
11	6-3/4	1-3/4	10-3/8	6-1/8	1-5/8	-	-	-	T600	-	-	-	-	6	6.00
10-7/8	7-3/8	1-3/4	10-7/16	6-5/8	1-9/16	-	-	-	T4006	-	-	-	-	6	5.10
11	6-3/4	1-3/4	10-1/2	6-9/16	1-1/2	-	-	K616R	T616R	M616R	-	-	-	24	25.40
13-1/2	9-1/2	2-3/16	13-1/8	8-5/8	1-7/8	-	-	-	T900	-	-	-	-	6	10.62
14-1/8	9	2	13-3/4	8-1/4	1-3/4	-	-	-	T5004	-	-	-	-	6	7.10
16-1/2	9-3/4	3-1/4	16	9	2-7/8	-	-	-	T7004	-	-	-	-	6	10

## 11 Compartments

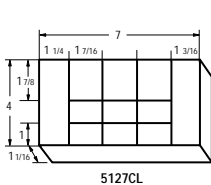

5127CL

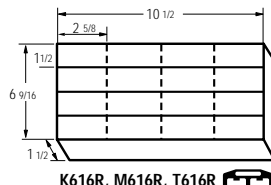

K616R, M616R, T616R

MODEL NUMBER TABLE								Std. Pkg	Pkg Wt (lbs.)
Styrene	Diamondback™	K-Resin®	Translucent Polyprop.	Yellow Polyprop.	Sand Polyprop.	Mighty-Tuff™	Precision		

Outside Dimensions			Inside Dimensions			MODEL NUMBER TABLE								Std. Pkg	Pkg Wt (lbs.)
L	W	H	L	W	H	Styrene	Diamondback™	K-Resin®	Translucent Polyprop.	Yellow Polyprop.	Sand Polyprop.	Mighty-Tuff™	Precision		
7	4	1-1/2	6-5/8	3-3/8	1-5/16	-	-	-	T2003	-	-	-	-	12	3.13
7-1/4	4-1/2	1-1/4	7	4	1-1/16	-	-	-	-	-	-	5127CL	-	12	4.88
9-1/8	4-15/16	1-3/8	8-13/16	4-3/16	1-3/16	-	-	-	T3003	-	-	-	-	12	4.11
11	6-3/4	1-3/4	10-3/8	6-1/8	1-5/8	-	-	-	T600	-	-	-	-	6	6.00
10-7/8	7-3/8	1-3/4	10-7/16	6-5/8	1-9/16	-	-	-	T4006	-	-	-	-	6	5.10
11	6-3/4	1-3/4	10-1/2	6-9/16	1-1/2	-	-	K616R	T616R	M616R	-	-	-	24	25.40
13-1/2	9-1/2	2-3/16	13-1/8	8-5/8	1-7/8	-	-	-	T900	-	-	-	-	6	10.62
14-1/8	9	2	13-3/4	8-1/4	1-3/4	-	-	-	T5004	-	-	-	-	6	7.10





# Inside Dimensions

## 12 Compartments

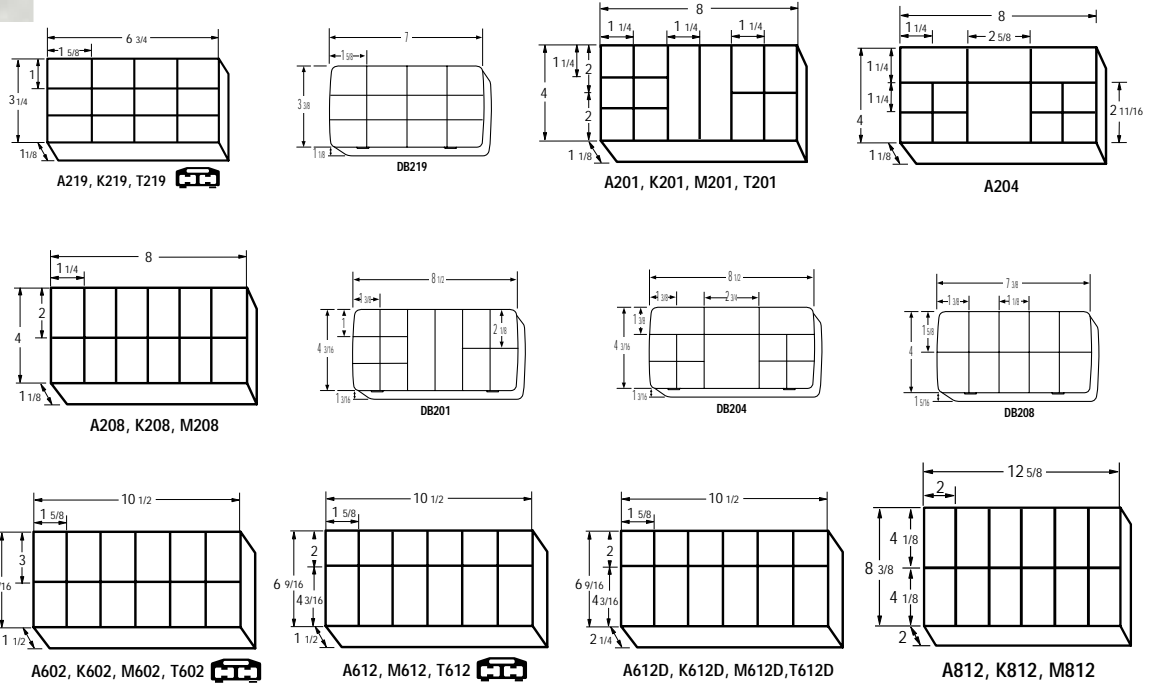

							MODEL NUMBER TABLE									
Outside Dimensions			Inside Dimensions				Material								Std. Pkg	Pkg Wt (lbs.)
L	W	H	L	W	H	Styrene	Diamondback™	K-Resin®	Translucent Polyprop.	Yellow Polyprop.	Sand Polyprop.	Mighty-Tuff™	Precision			
7	3-3/4	1-1/4	6-3/4	3-1/4	1-1/8	A219	-	K219	T219	-	-	-	-	36	10.81	
7	4	1-1/2	6-5/8	3-3/8	1-5/16	-	-	-	T2003	-	-	-	-	12	3.13	
7-3/8	4	1-5/16	7	3-3/8	1-1/8	-	DB219	-	-	-	-	-	-	50	12.38	
8-1/4	4-1/2	1-3/8	8	4	1-1/8	A201	-	K201	T201	M201	-	-	-	24	10.31	
8-1/4	4-1/2	1-3/8	8	4	1-1/8	A204	-	-	-	-	-	-	-	24	9.81	
8-1/4	4-1/2	1-3/8	8	4	1-1/8	A208	-	K208	-	M208	-	-	-	24	10.43	
8-7/8	4-7/8	1-3/8	8-1/2	4-3/16	1-3/16	-	DB204	-	-	-	-	-	-	48	21.00	
8-7/8	4-7/8	1-3/8	8-1/2	4-3/16	1-3/16	-	DB208	-	-	-	-	-	-	48	20.31	
8-7/8	4-7/8	1-3/8	8-1/2	4-3/16	1-3/16	-	DB201	-	-	-	-	-	-	48	21.00	
9-1/8	4-15/16	1-3/8	8-13/16	4-3/16	1-3/16	-	-	-	T3003	-	-	-	-	12	4.11	
11	6-3/4	1-3/4	10-3/8	6-1/8	1-5/8	-	-	-	T600	-	-	-	-	6	6.00	
10-7/8	7-3/8	1-3/4	10-7/16	6-5/8	1-9/16	-	-	-	T4006	-	-	-	-	6	5.10	
11	6-3/4	1-3/4	10-1/2	6-9/16	1-1/2	A602	-	K602	T602	M602	-	-	-	24	28.88	
11	6-3/4	1-3/4	10-1/2	6-9/16	1-1/2	A612	-	-	T612	M612	-	-	-	24	28.31	
11	6-3/4	1-3/4	10-1/2	6-9/16	1-1/2	-	-	K616R	T616R	M616R	-	-	-	24	25.40	
11	6-3/4	2-1/2	10-1/2	6-9/16	2-1/4	A612D	-	K612D	T612D	M612D	-	-	-	24	26.10	
13-1/8	9	2-5/16	12-5/8	8-3/8	2	A812	-	K812	-	M812	-	-	-	12	22.50	
13-1/2	9-1/2	2-3/16	13-1/8	8-5/8	1-7/8	-	-	-	T900	-	-	-	-	6	10.62	
14-1/8	9	2	13-3/4	8-1/4	1-3/4	-	-	-	T5004	-	-	-	-	6	7.10	
16-1/2	9-3/4	3-1/4	16	9	2-7/8	-	-	-	T7004	-	-	-	-	6	10	



# Inside Dimensions

## 13 Compartments

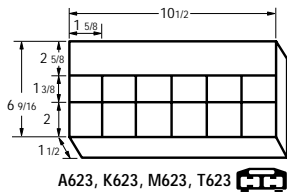

A623, K623, M623, T623

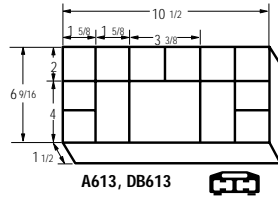

A613, DB613

MODEL NUMBER TABLE

Outside Dimensions			Inside Dimensions			MODEL NUMBER TABLE								Std. Pkg	Pkg Wt (lbs.)
L	W	H	L	W	H	Styrene	Diamondback™	K-Resin®	Translucent Polyprop.	Yellow Polyprop.	Sand Polyprop.	Mighty-Tuff™	Precision		
7	4	1-1/2	6-5/8	3-3/8	1-5/16	-	-	-	T2003	-	-	-	-	12	3.13
9-1/8	4-15/16	1-3/8	8-13/16	4-3/16	1-3/16	-	-	-	T3003	-	-	-	-	12	4.11
10-7/8	7-3/8	1-3/4	10-7/16	6-5/8	1-9/16	-	-	-	T4006	-	-	-	-	6	5.10
11	6-3/4	1-3/4	10-1/2	6-9/16	1-1/2	A613	DB613	-	-	-	-	-	-	24	27.81
11	6-3/4	1-3/4	10-1/2	6-9/16	1-1/2	-	-	K616R	T616R	M616R	-	-	-	24	25.40
11	6-3/4	1-3/4	10-1/2	6-9/16	1-1/2	A623	-	K623	T623	M623	-	-	-	24	26.50
13-1/2	9-1/2	2-3/16	13-1/8	8-5/8	1-7/8	-	-	-	T900	-	-	-	-	6	10.62
14-1/8	9	2	13-3/4	8-1/4	1-3/4	-	-	-	T5004	-	-	-	-	6	7.10
16-1/2	9-3/4	3-1/4	16	9	2-7/8	-	-	-	T7004	-	-	-	-	6	10

## 17 Compartments

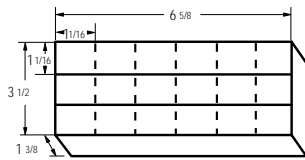

**T2003**  
(includes 15 movable dividers for up to 18 compartments)

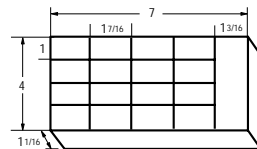

5126CL

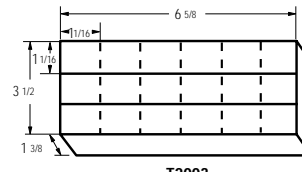

**T2003**  
(includes 15 movable dividers for up to 18 compartments)

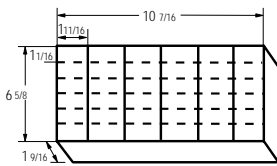

**T4006**  
(includes 12 movable dividers)

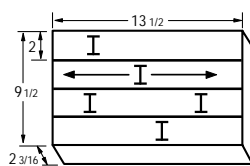

**T900**  
(includes 16 movable dividers for up to 20 compartments)

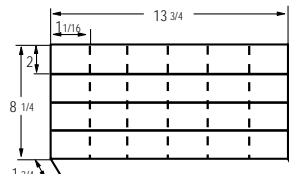

**T5004**  
(includes 20 movable dividers for up to 24 compartments)

MODEL NUMBER TABLE

Outside Dimensions			Inside Dimensions			MODEL NUMBER TABLE								Std. Pkg	Pkg Wt (lbs.)
L	W	H	L	W	H	Styrene	Diamondback™	K-Resin®	Translucent Polyprop.	Yellow Polyprop.	Sand Polyprop.	Mighty-Tuff™	Precision		
7	4	1-1/2	6-5/8	3-3/8	1-5/16	-	-	-	T2003	-	-	-	-	12	3.13
7-1/4	4-1/2	1-1/4	7	4	1-1/16	-	-	-	-	-	-	5126CL	-	12	5.00
9-1/8	4-15/16	1-3/8	8-13/16	4-3/16	1-3/16	-	-	-	T3003	-	-	-	-	12	4.11
10-7/8	7-3/8	1-3/4	10-7/16	6-5/8	1-9/16	-	-	-	T4006	-	-	-	-	6	5.10
13-1/2	9-1/2	2-3/16	13-1/8	8-5/8	1-7/8	-	-	-	T900	-	-	-	-	6	10.62
14-1/8	9	2	13-3/4	8-1/4	1-3/4	-	-	-	T5004	-	-	-	-	6	7.10
16-1/2	9-3/4	3-1/4	16	9	2-7/8	-	-	-	T7004	-	-	-	-	6	10



# Inside Dimensions

## 18 Compartments

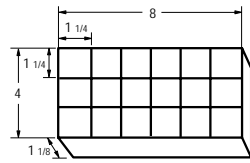

A200, K200, M200, T200

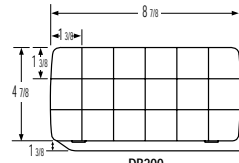

DB200

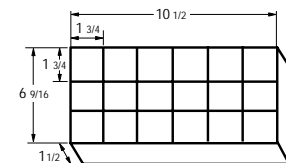

A618, C618, K618  
M618, T618

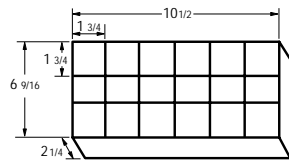

A618D, K618D, M618D, T618D, DB618

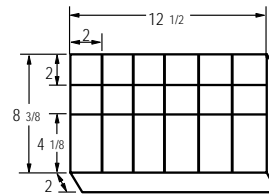

A818, K818, M818

Outside Dimensions			Inside Dimensions			MODEL NUMBER TABLE							Std. Pkg	Pkg Wt (lbs.)	
						Styrene	Diamondback™	K-Resin®	Translucent Polyprop.	Yellow Polyprop.	Sand Polyprop.	Mighty-Tuff™			Precision
L	W	H	L	W	H										
7	4	1-1/2	6-5/8	3-3/8	1-5/16	-	-	-	T2003	-	-	-	-	12	3.13
8-1/4	4-1/2	1-3/8	8	4	1-1/8	A200	-	K200	T200	M200	-	-	-	24	11.10
8-7/8	4-7/8	1-3/8	8-1/2	4-3/16	1-3/16	-	DB200	-	-	-	-	-	-	48	21.50
9-1/8	4-15/16	1-3/8	8-13/16	4-3/16	1-3/16	-	-	-	T3003	-	-	-	-	12	4.11
10-7/8	7-3/8	1-3/4	10-7/16	6-5/8	1-9/16	-	-	-	T4006	-	-	-	-	6	5.10
11	6-3/4	1-3/4	10-1/2	6-9/16	1-1/2	A618	DB618	K618	T618	M618	-	-	-	24	29.12
11	6-3/4	2-1/2	10-1/2	6-9/16	2-1/4	A618D	-	K618D	T618D	M618D	-	-	-	24	27.30
13-1/8	9	2-5/16	12-1/2	8-3/8	2	A818	-	K818	-	M818	-	-	-	12	23.12
13-1/2	9-1/2	2-3/16	13-1/8	8-5/8	1-7/8	-	-	-	T900	-	-	-	-	6	10.62
14-1/8	9	2	13-3/4	8-1/4	1-3/4	-	-	-	T5004	-	-	-	-	6	7.10





# Inside Dimensions

## 24 Compartments

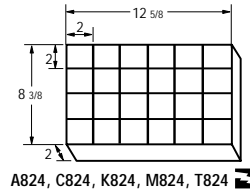
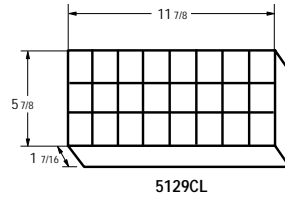
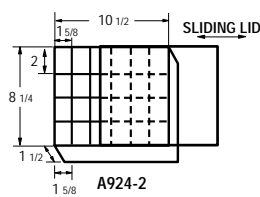

Outside Dimensions			Inside Dimensions			MODEL NUMBER TABLE								Std. Pkg	Pkg Wt (lbs.)
L	W	H	L	W	H	Styrene	Diamondback™	K-Resin®	Translucent Polyprop.	Yellow Polyprop.	Sand Polyprop.	Mighty-Tuff™	Precision		
10-3/4	8-7/8	1-13/16	10-1/2	8-1/4	1-1/2	A924-2	-	-	-	-	-	-	-	10	15.50
12-1/4	6-1/8	1-1/2	11-7/8	5-7/8	1-7/16	-	-	-	-	-	-	5129CL	-	6	6.43
13-1/8	9	2-5/16	12-5/8	8-3/8	2	A824	-	K824	T824	M824	-	-	-	12	23.81
14-1/8	9	2	13-3/4	8-1/4	1-3/4	-	-	-	T5004	-	-	-	-	6	7.10

## 36 Compartments

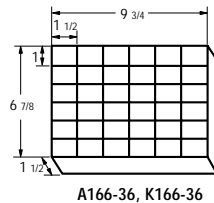

Outside Dimensions			Inside Dimensions			MODEL NUMBER TABLE								Std. Pkg	Pkg Wt (lbs.)
L	W	H	L	W	H	Styrene	Diamondback™	K-Resin®	Translucent Polyprop.	Yellow Polyprop.	Sand Polyprop.	Mighty-Tuff™	Precision		
10	7-1/8	1-11/16	9-3/4	6-7/8	1-1/2	A166-36	-	K166-36	-	-	-	-	-	24	24.56



# Compartmented Boxes Outside Dimensions (Lid Closed)

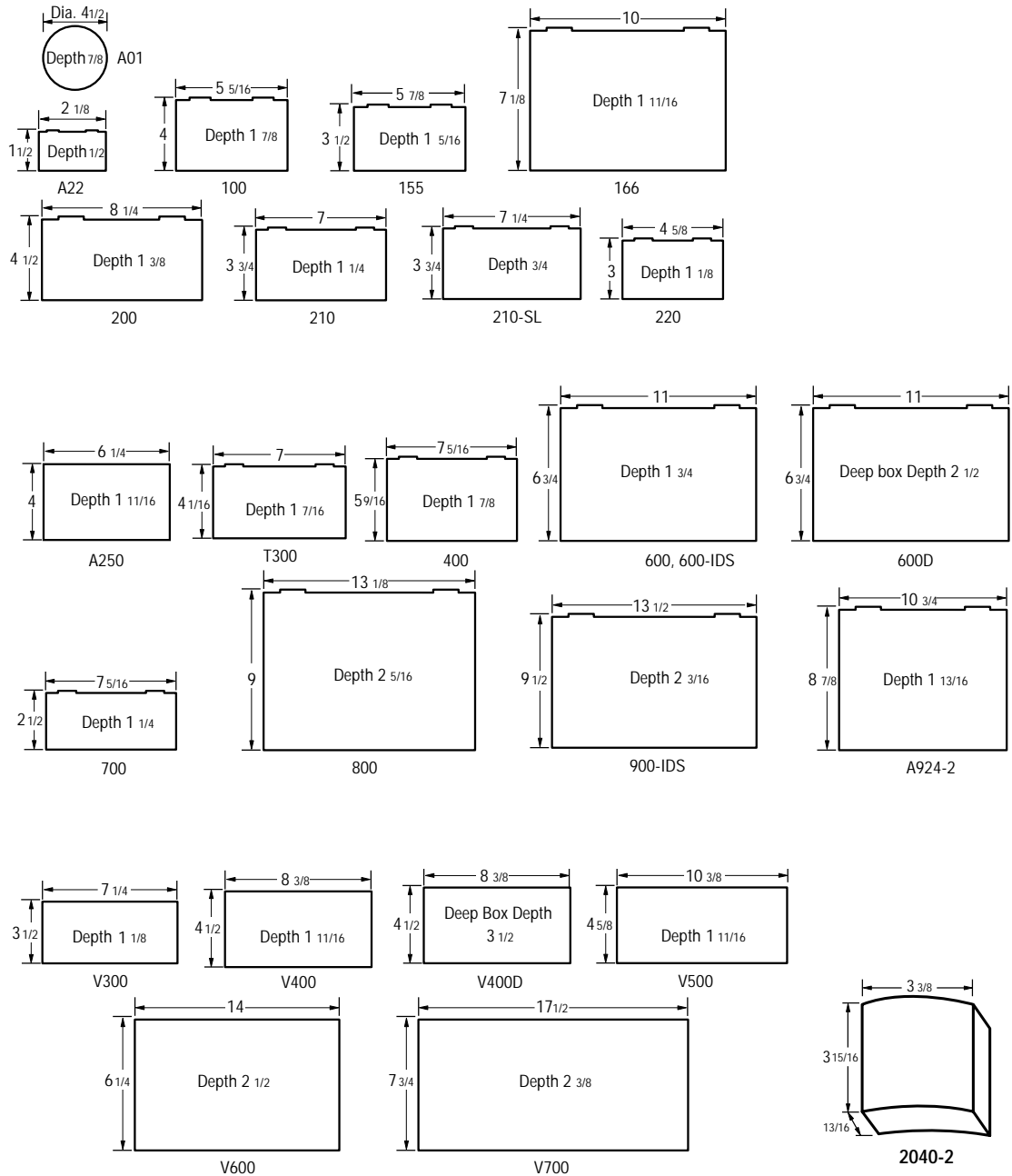





# Compartmented Boxes Outside Dimensions (Lid Closed)

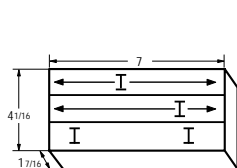

**T300**  
(includes 6 movable dividers  
for up to 9 compartments)

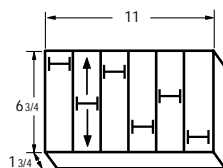

**T600**  
(includes 6 movable dividers)

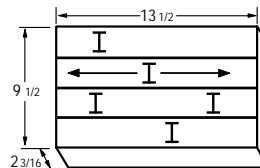

**T900**  
(includes 16 movable dividers)

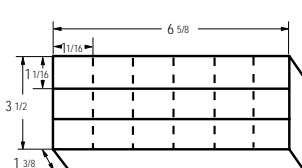

**T2003**  
(includes 15 movable dividers  
for up to 18 compartments)

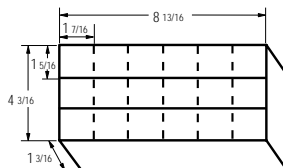

**T3003**  
(includes 15 movable dividers  
for up to 18 compartments)

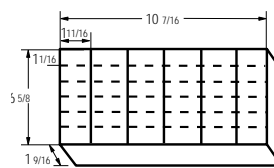

**T4006**  
(includes 12 movable dividers  
for up to 18 compartments)

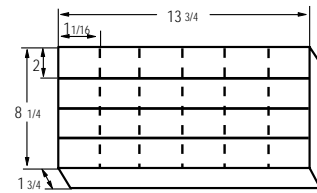

**T5004**  
(includes 20 movable dividers  
for up to 24 compartments)

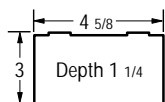

**5200CL, 5202CL,  
5204CL, 5206CL**

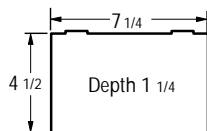

**5126CL, 5127CL,  
5128CL**

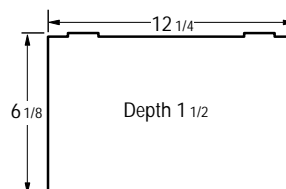

**5129CL, 5130CL**

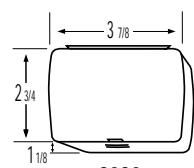

**2020**

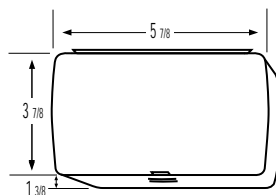

**3030**

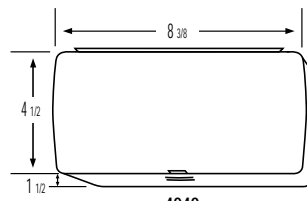

**4040**

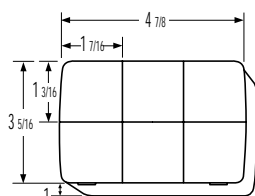

**DB220**

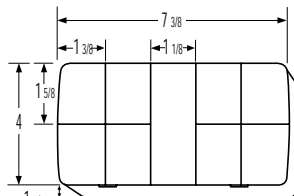

**DB210**

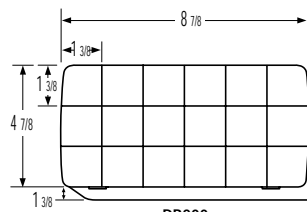

**DB200**



# Mobile Storage Systems

Flambeau's Mobile Storage Systems lets you take your work with you. Whether you need to organize a few tools, a few parts, or an entire tool box, going across the shop or across the plant from the Utility Work Station™ to the Carry Packs, our Mobile Storage Systems makes your job easier.



4

# Utility Workstation™



Working on projects will be easier utilizing Flambeau's Utility Workstation™. Ideal for toolrooms, MRO areas, temporary storage and for servicing vehicles. This mobile system includes a sliding lid, which can be used as a work surface or removed and conveniently stored on the side of the Workstation. The lid can also be locked to secure items in the top tray. Two large compartmented cases fit in the top tray for organized parts storage. Additional flexibility comes from attachable bins and bulk storage bottom tray.

## Ordering Information

Stock No.	Description	Dimensions	Pk Per Carton	Weight
8510ST	Utility Workstation™	29 x 22 x 40	1	38 lbs.

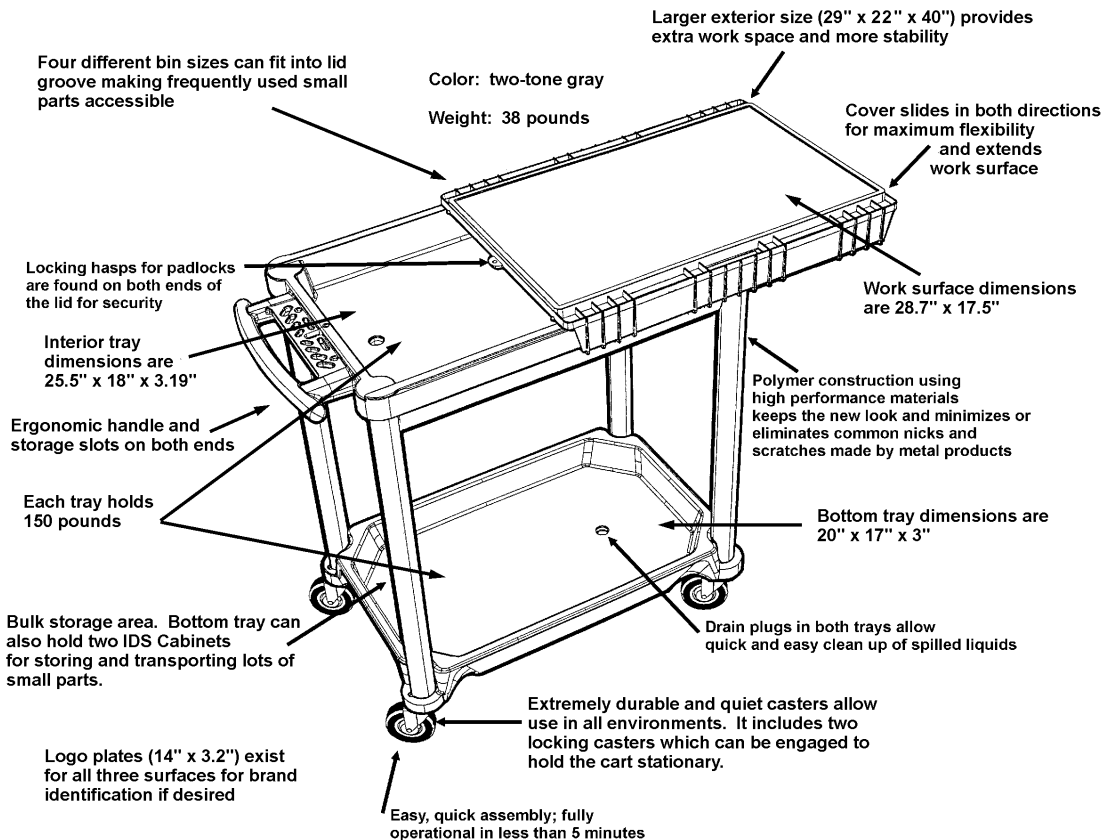

# Utility Boxes

Flambeau Utility Boxes feature spacious open interiors and are available with or without lift-out trays to accommodate any need.

- Manufactured from lightweight co-polymer resins that are non-conductive, dentproof, rustproof and scratch resistant.
- Brass hinge and latch pins.
- Tough recessed handles.
- Resistant to oils and most common chemicals.
- Positive action latches.
- Tongue and groove construction.



## Utility Boxes

Stock No.	Model No.	Overall* W x D x H	Color	Standard Package	Package Wt. lbs.
6734UB	1100	12-1/8 x 7-1/4 x 4-1/2	Gray	6	8.0
6736UB	1200	12-1/8 x 7-1/4 x 5-1/2	Gray	6	9.5
6742UB	1400	14-3/8 x 8 x 7	Gray	6	13.5
6746UB	1700	16-3/8 x 8-5/8 x 7	Gray	4	11.0
6752UB	1800	17-1/2 x 10-1/4 x 8-1/2	Gray	4	14.0
6760UB	2100	19 x 11-1/2 x 10-1/2	Gray	2	12.5

\*Includes lid overlap and hinges.

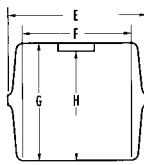
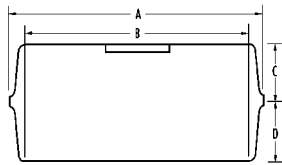

Box #	A	B	C	D	E	F	G	H
1100	12-1/8	11-1/8	1-3/4	2-3/4	7-1/4	5-3/4	4-3/8	4
1200	12-1/8	11-1/8	2-3/4	2-3/4	7-1/4	5-3/4	5-5/8	5-1/4
1400	14-3/8	13	3-1/2	3-1/2	8	6	6-3/4	6-1/4
1700	16-3/8	15	3-1/2	3-1/2	8-5/8	6-7/8	7	6-1/2
1800	17-1/2	15-5/8	4-1/4	4-1/4	10-1/4	7-3/4	8-3/8	7-3/4
2100	19	17-1/8	5-1/4	5-1/4	11-1/2	8-5/8	10	9-1/4

Models 1800 and 2100 have lock tabs

## Utility Boxes with Lift-Out Trays



Stock No.	Model No.	Overall W x D x H	Color	Standard Package	Package Wt. lbs.	Available
6742HS	Lil Brute w/out Tray	13 x 6 x 5-3/8	Black	6	12.0	
6743HS	Lil Brute w/Tray	13 x 6 x 5-3/8	Black	6	12.0	
6744HS	14800-2	14-1/2 x 7-1/2 x 5-1/4	Gray	6	12.0	14800-2C
6748HS	17800-2	16-5/8 x 8-3/4 x 7-1/8	Gray	4	14.0	
6757HS	19800-2	20-1/4 x 8-7/8 x 8-3/8	Gray	4	18.0	
6759HS	23800-2	23 x 10-1/2 x 11-3/8	Gray	2	14.0	
6754TC	27800-2	27-1/2 x 13-3/4 x 14	Gray	2	22.1	

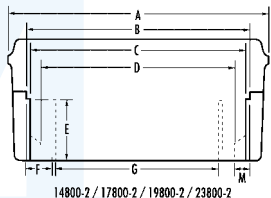
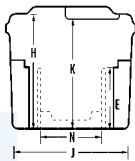

14800-2 / 17800-2 / 19800-2 / 23800-2

Model	A	B	C	D	E	F	G	H	J	K	L	M	N	Tray Dimensions
14800-2	14-1/2	13	•	•	2-3/8	2-5/8	7-3/8	7-1/4	5-3/8	4-1/4	4-1/2	•	•	12-1/4 x 4-3/4 x 1-1/2
17800-2	16-1/2	14-1/2	13	•	3-1/2	•	•	8-1/4	6-1/8	6	6-1/2	•	4-3/16	13-3/4 x 5-5/8 x 1-7/8
19800-2	20-1/4	18-1/8	16-3/4	•	4-3/8	•	•	9	6-1/2	7-1/8	7-3/4	•	4-3/16	17-5/8 x 6-3/8 x 2-3/16
23800-2	23-1/8	20-5/8	19-3/4	17-3/8	6-1/4	•	•	10-1/4	7-1/2	10	10-1/2	1-3/4	4-7/8	20-5/8 x 7-1/2 x 2
27800-2	27-5/8	23	•	•	8-1/4	11-3/4	1-1/2	9-7/8	12-1/2	12	•	11-3/4	10-5/8	11-1/2 x 2-1/4 x 11



## Utility Boxes with Cantilever Trays

Rugged Utility Boxes featuring Tip Guard™ cantilever trays make it easy to organize tools and parts, repair kits, samples or sports equipment in a small space.

- Manufactured from lightweight co-polymer resins that are lightweight, dentproof, rustproof and scratch resistant.
- Tough recessed handles.
- Cantilever Tip Guard™ Tray Supports.
- Brass hinge pins and latch pins.
- Resistant to oils and most common chemicals.
- Positive action latches.
- Tongue and groove construction.

### Utility Boxes with Cantilever Trays

Stock No.	Model No.	Overall* W x D x H	No. of Trays	No. of Tray Compartments	Color	Standard. Package	Package Wt. lbs.
6734HS	11090-2	13-1/4 x 7-1/4 x 5-3/4	1	2-12	Gray	6	10.0
6749HS	17090-2	16-3/8 x 8-5/8 x 7	2	11	Gray	4	19.0
6755HS	18090-2	17-1/2 x 10-1/4 x 8-1/2	2	9	Gray	4	23.5
6756HS	19060-2	18-1/2 x 10-3/4 x 10-3/8	6	35	Gray	1	9.0

\*Includes lid overlap and hinges.

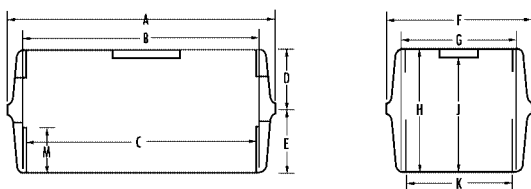

Model	A	B	C	D	E	F	G	H	J	K	M
11090-2	13	12-1/4	10-3/4	2-1/4	3-1/2	7-1/4	6-1/2	5-1/4	4-3/4	6-1/4	2-7/8
17090-2	16-3/8	15	13-7/8	3-1/2	3-1/2	8-5/8	6-7/8	7	6-1/2	6-3/4	3-1/2
18090-2	17-1/2	15-5/8	14-3/8	4-1/4	4-1/4	10-1/4	7-3/4	8-3/8	7-3/4	6-1/2	4
19060-2	18-1/2	15-1/2	15-1/4	4-3/4	4	10-3/4	7-1/2	9	8-1/2	7-1/4	4-1/2

Inside dimensions



19060-2



18090-2







## Utility Tote

- Co-polymer resins resist scratching, fading and rusting.
- Pull out tray on bottom can be opened from either side.
- Large built-in handle.
- Ideal for service areas or vehicles.

Stock No.	Description Model No.	Overall W x D x H	Color	Standard Package	Package Wt. lbs.
6769HS	Tool Tote 16500-2	16-5/8 x 10-1/4 x 6-7/8	Gray/Lt. Gray Drawers	6	13.4



## Utility Bench Box

- Spacious 20" x 8" x 4" top.
- Two large pull-out drawers.
- Drawers can be secured from accidental opening.
- Dividers included for customization.
- Fold down handle.

Stock No.	Description Model No.	Overall W x D x H	Color	Standard Package	Package Wt. lbs.
6758HS	Bench Box 21800-2	21-3/4 x 10-3/4 x 9-3/8	Charcoal Gray/Lt. Gray Drawers	2	20.0

# 4



## Speciality Utility Boxes



Flambeau Speciality Utility Boxes fill a need standard tool boxes cannot.

### Expandable Building Box

- Manufactured from lightweight co-polymer resins that are non-conductive, dentproof, rustproof and scratch resistant.
- Ergonomic handle.
- Spacious 18" x 11" x 3 1/2" top interior.
- Includes two (2) Infinite Divider System Boxes (999-2).
- Additional trays available with Expansion Kit.
- Top can be ordered separately.

Stock No.	Model No.	Overall W x D x H	Color	Standard Package	Package Wt. lbs.
6730HS	13900-2	18-1/2 x 12-1/2 x 11-3/4	-	4	18.0
6731HS	13901-2-Expansion Kit	16-3/16 x 10-1/16 x 3-1/4	Tray - Black	6	5.0
6735HS	18192-2	18-1/2 x 12-1/2 x 6	Tool Box - Yellow	4	12.0



### Stand 'N Store™ Step Stool

- Supports over 300 pounds.
- Portable.
- Interior storage area 15" x 8" x 7".
- Lift-out tray.
- Ideal for maintenance areas, production shops or anywhere you need that little extra reach.

Stock No.	Description Model No.	Overall W x D x H	Color	Standard Package	Package Wt. lbs.
6759TC	Step 'N Store 22500-3	21-5/8 x 15 x 13-1/4	Safety Yellow	2	18.0



# Carry Packs



Carry Packs take system storage one step further with their many versatile uses. Available in three different sizes, the 20220-2 and 21210-2 Carry Packs can hold up to four compartmented boxes, while the 21600-2 can hold two. Available in Styrene, K-Resin, or Polypropylene, each compartmented box slides in and out of the rack for quick and easy access. Carry Packs snap into a folded position for easy transportation or can be left open for convenient wall storage. Carry Packs frames can be ordered separately.

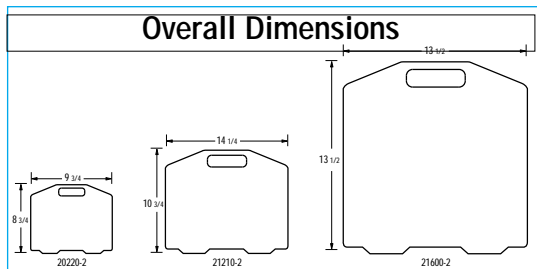

SERIES Carry Packs	Overall W x D x H	Color	Standard Package	Package Wt. lbs.
20220-2	9-3/4 x 8-3/4 x 1-1/2	Grey	6	4.6
21210-2	14-1/4 x 10-3/4 x 1-1/2	Grey	6	8.5
21600-2	13-7/16 x 13-1/2 x 2-1/8	Grey	6	8.8

Box styles to fit Carry Packs

## Styrene, K-Resin or Polypropylene Box Configurations

Choose any four of the box configurations listed for Carry Packs 20220-2\*:

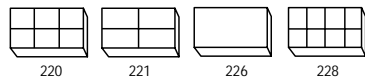

Choose any four of the box configurations listed for Carry Packs 21210-2\*:

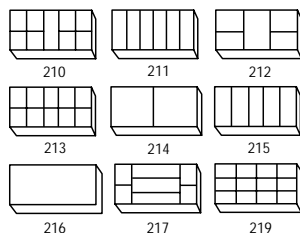

Carry Packs Model No.	Box Model Number			Stocked with Box Models	
	Styrene	K-Resin	Polypropylene		
	Opaque	Translucent			
20220-2	A220	K220	M220	T220	T220 (2 ea.) & T221 (2 ea.)
	A221	•	M221	T221	
	A226	K226	•	•	
	A228	•	•	•	
21210-2	A210	K210	M210	T210	T210 (2 ea.) & T215 (2 ea.)
	A211	•	•	•	
	A212	•	•	•	
	A213	•	•	•	
	A214	•	•	•	
	A215	K215	M215	T215	
	A216	K216	•	•	
	A217	•	•	•	
	A219	K219	•	T219	
21600-2	•	•	•	T600-IDS	
	A601	K601	•	•	T612 (1 ea.) & T618 (1 ea.)
	A602	K602	M602	•	
	A603	•	•	•	
	M606	K606	M606	T606	
	A607	K607	•	•	
	A612	•	M612	T612	
	A613	•	•	•	
	•	K616R	M616-R	T616-R	
	A618	K618	M618	T618	
	A623	K623	M623	•	

Choose any two of the box configurations listed for Carry Packs 21600-2\*:

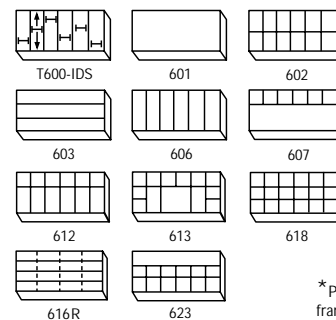

\*Please specify Carry Packs frame sizes with appropriate box configurations when ordering.



## Drawer Cabinets and Chests



These large professional units are designed to organize, store and protect precision tools, hardware and small parts. Common features include interchangeable drawers with adjustable compartment sizes, padlock tab, two positive action latches, brass hinge and brass latch pins. All components are molded in high-impact resins, resistant to most chemicals, common solvents and oils. Model 22030-2 is molded in an industrial grade ABS plastic.

The Drawer Cabinet features a self-storing door panel providing all-weather protection for all the drawer configurations. Each Tool Chest has a unique front panel design that allows drawer access when the front panel is down. A unique lock prevents accidental spills and allows the lid and drawers to lift as a unit, providing access to the large lower storage area.

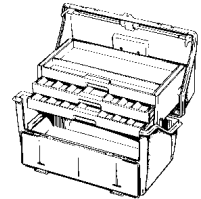

22030-2

### Cabinet Dimensions

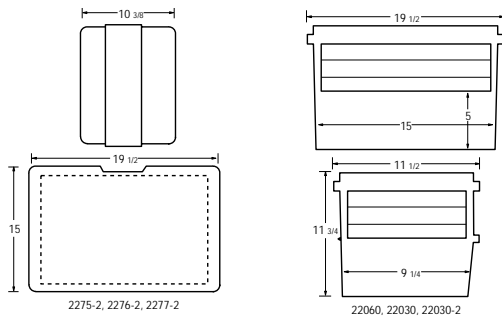

### Drawer Dimensions

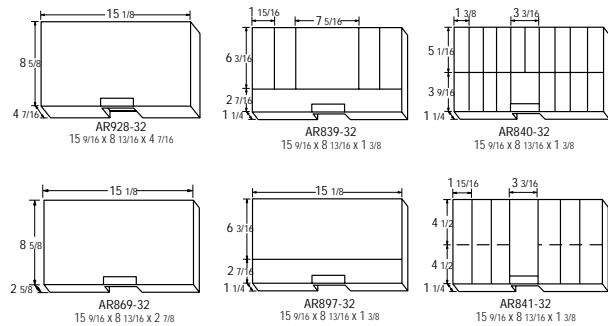

Stock No.	Model No.	Overall W x D x H	Color	Drawer Color	Standard Package	Package Wt. lbs.	Drawer Configurations
6763DB	2275-2	19-1/2 x 10-3/8 x 15	Brown/Tan ABS	Orange	1	18.3	  
6764DB	2276-2	19-1/2 x 10-3/8 x 15	Brown/Tan ABS	Orange	1	18.6	   
6765DB	2277-2	19-1/2 x 10-3/8 x 15	Brown/Tan ABS	Orange	1	20.1	  
6596DH	22060	19-1/2 x 10-3/8 x 15	Gray High Impact Material	Gray	1	18.0	  
6593CH	22030	19-1/2 x 11-1/2 x 11-3/4	Gray High Impact Material	Gray	1	12.0	 
6759CH	22030-2	19-1/2 x 11-1/2 x 11-3/4	Gray ABS	Orange	1	12.5	



# Stationary Storage Systems

Create your own custom storage systems. Our Satchel-Style Cases are handsomely molded from rugged copolymer resins to meet a variety of storage carrying needs. Flambeau's Bin Rototower provides a large amount of storage capacity in a small narrow space. Our Frame Storage Cabinets are designed to meet small storage needs.







## Compartmented Cases

### Satchel-Style Cases

Handsome satchel-style cases molded from rugged copolymer resins to meet a variety of storage carrying needs. Flambeau quality features include: comfortable handle, double positive latches, pinned hinges and translucent cover. Copolymer resin provides a rustproof, odor and oil resistant case for almost unlimited use. Each of these cases may be individualized through custom coloring and hot stamping. Customization is available. Ask us for our quotation.

### Standards include

- Translucent lids allow for quick identification of contents.
- Rounded corners, no sharp edges and lightweight covers that won't slam on fingers make these cases "user friendly."
- Molded from copolymer resins that resist common solvents and odors, will not rust or dent.
- Brass hinge pins for optimum strength and durability.
- Identification card holder for quick case selection.
- Comfortable, strong luggage-style handle.
- Positive latches keep lids secure.
- Minimum order sizes apply.

### Custom Options

- Lids can be imprinted with your logo or message.
- Color of your choice - minimum quantities apply.

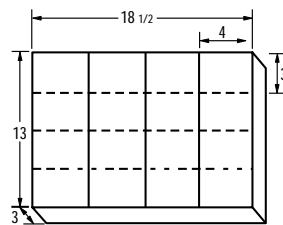

1016-2 Includes 12 dividers

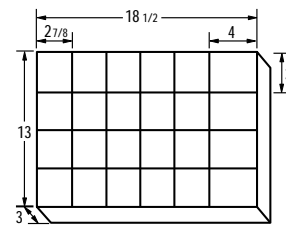

1024-2

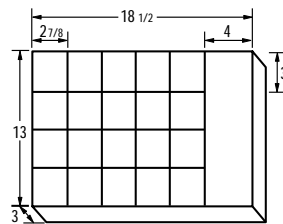

1021-2

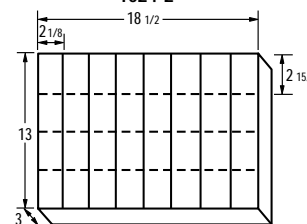

1032-2 Includes 24 dividers



## Large Compartmented Cases

Stock No.	Model Number	Overall W x H x D	Number of Compartments	Standard Package	Package Wt. lbs.
6745AB	1016-2	18-1/2 x 13 x 3	4 to 16	6	22.8
6745AG	1021-2	18-1/2 x 13 x 3	21	6	22.8
6745AA	1024-2	18-1/2 x 13 x 3	24	6	22.8
6745AC	1032-2	18-1/2 x 13 x 3	8 to 32	6	22.8
6745LS	LS-1-Base	20-3/4 x 16 x 15	N/A	1	15.0
6745LC	LC-4-Cabinet	20-1/4 x 15-3/4 x 14-3/4	N/A	1	39.0



## Small Compartmented Cases

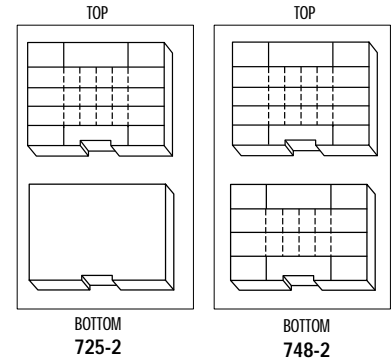
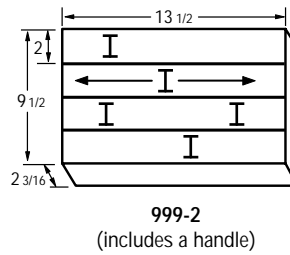
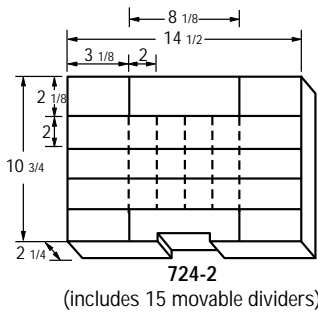
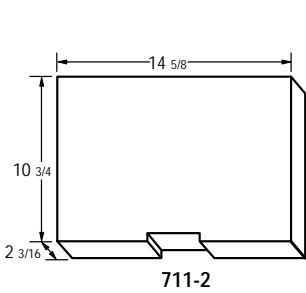

Stock No.	Model No.	Overall W x H x D	Number of Compartments	Standard Package	Package Wt. lbs.
6771UA	711-2	15-1/2 x 11-3/4 x 2-1/2	1	12	26.0
6770PA	724-2	15-1/2 x 11-3/4 x 2-1/2	9-24	12	35.0
6773AB	725-2	15-1/2 x 11-3/4 x 5	10-25	6	35.0
6772AD	748-2	15-1/2 x 11-3/4 x 5	18-48	6	35.0
6726ID	999-2	13-1/2 x 9-1/2 x 2-13/16	4-16	6	8.0

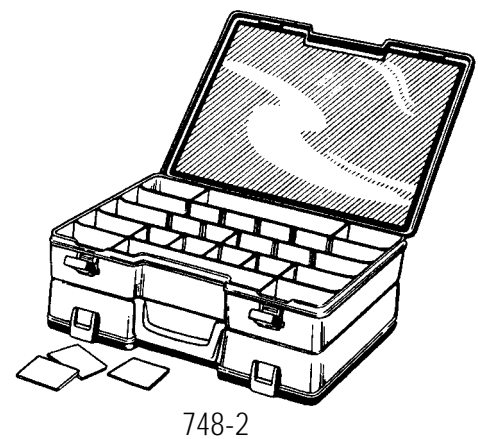
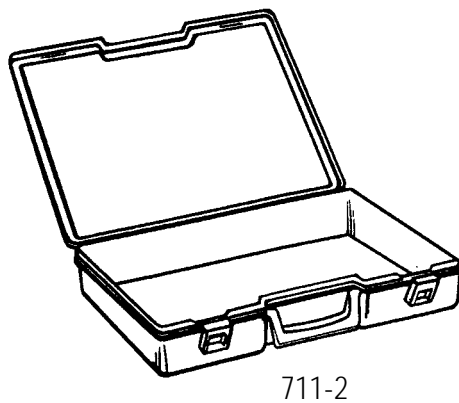



## Bin Storage Systems

Create your own storage systems using Flambeau Storage Bins. They may be stacked, mounted on a steel rail, desk stand, or incorporated into the Bin Rototower™. All bins are available in red, yellow or blue. Flambeau bins are molded of heavy-duty polypropylene material that is durable, rustproof and resists oil and common chemicals. The Bin Rototower™ provides a large amount of storage in a small amount of floor space as does the 350BT that gives you the ability to select your own assortment. The Rototower™ holds a total of 144 of the #60 bin; 96 of the #120 bin; 72 of the #240 bin; 64 of the #480 bin - or the bin combination of your choice. Weight capacity: Approximately 992 pounds.

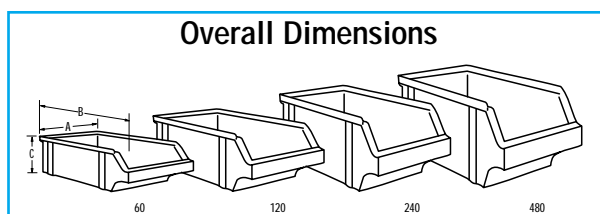

Stock No.	Bin Number	Overall A x B x C	Color			Standard Package	Package Wt. lbs.
			Yellow	Blue	Red		
6794YB	60Y	4-7/8 x 5-1/8 x 2	•			24	4.0
6794BB	60B	4-7/8 x 5-1/8 x 2		•		24	4.0
6794RB	60R	4-7/8 x 5-1/8 x 2			•	24	4.0
6795YB	120Y	4-7/8 x 6-5/8 x 3	•			24	6.0
6795BB	120B	4-7/8 x 6-5/8 x 3		•		24	6.0
6795RB	120R	4-7/8 x 6-5/8 x 3			•	24	6.0
6796YB	240Y	4-7/8 x 8-7/8 x 3-7/8	•			12	4.7
6796BB	240B	4-7/8 x 8-7/8 x 3-7/8		•		12	4.7
6796RB	240R	4-7/8 x 8-7/8 x 3-7/8			•	12	4.7
6797YB	480Y	4-7/8 x 12 x 5-7/8	•			12	9.7
6797BB	480B	4-7/8 x 12 x 5-7/8		•		12	9.7
6797RB	480R	4-7/8 x 12 x 5-7/8			•	12	9.7
6794BA	351BA	30 x 57	16-60Y, 24-120R, 24-240Y & 16-480B			1	109.0



Stock No.	Accessory Number	Overall L x W x D	Color			Standard Package	Package Wt. lbs.
			Gray	Tan	Lt Beige		
6796RL	SR4 Bin Rail	19-1/2 long, holds 4 bins	•			12	6.0
6795BC	350BT Bin Rototower™	18-1/4 x 57 unfilled bins not incl.		•		1	78.0
6774TT	50 BTR Bin Desk Stand	17-1/4 x 20 x 8-7/8			•	1	7.0
6794WP	75 BWP Bin Wall Panel	17-3/8 x 20-1/2 bins not incl.			•	6	19.0



## Plastic Frame Storage Cabinets

### Parts Station™ Storage Cabinets

High density storage can be achieved with these all-plastic cabinets. Maximize any work area by organizing and storing tools, hardware or parts. Flambeau Parts Stations™ are designed with a sturdy shell and drawer rail structure for extra strength. These rugged cabinets can be stacked or wall mounted for greater storage flexibility. Flambeau molds all drawers in clear styrene resin for optimum visibility and speedy retrieval of contents. Each cabinet features drawer stops to prevent accidental spills.

#### Overall Dimensions

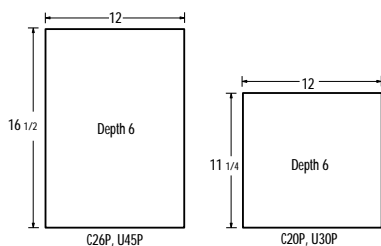

#### Drawer Type

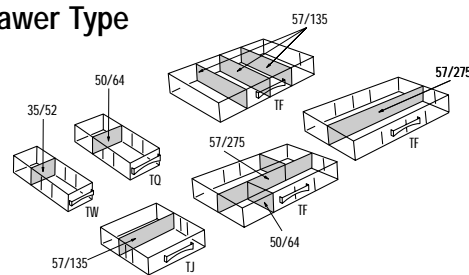

#### Ordering Information

Model	Cabinet Size H x W x D	Number of Drawers	Drawer Type	Divider Number	Standard Package	Package Wt. lbs.
C20P	11-1/4 x 12 x 6	15	TW	35/52	4	16.0
		4	TQ	50/64		
		1	TF	57/275		
C26P	16-1/2 x 12 x 6	15	TW	35/52	4	22.0
		8	TQ	50/64		
		2	TJ	57/135		
		1	TF	57/275		
U30P	11-1/4 x 12 x 6	30	TW	35/52	4	16.0
U45P	16-1/2 x 12 x 6	45	TW	35/52	4	22.0
U48P	14 x 11-1/2 x 5-3/4	48			6	22
U60P	14 x 14-1/4 x 5-3/4	60			6	26



**Plastic Frame Storage Cabinets: Specifications**

**Drawer**

Item	Overall H x W x D.	Color	Standard. Package	Package Wt. (oz.)
TW	1-3/8 x 2 x 5-5/16	Clear	1	1.0
TQ	2-1/4 x 2-1/2 x 5-5/16	Clear	1	2.0
TJ	2-1/4 x 5-5/16 x 5-5/16	Clear	1	3.5
TF	2-1/4 x 11 x 5-5/16	Clear	1	6.0

**Divider**

Item	Dimensions	Color	Standard. Package	Package Wt. (oz.)	Fits Drawer
35/52	1-3/8 x 2	Clear	48	7.0	TW
50/64	2-1/4 x 2-1/2	Clear	24	5.0	TQ
57/135	2-1/4 x 5-5/16	Clear	12	8.0	TF & TJ
57/275	2-1/4 x 11	Clear	6	10.0	TF

Standard plastic frame storage cabinets are gray with clear drawers. Conductive plastic frame storage cabinets and drawers are black.

**Series 160 Rototower™**

Product Number	Description	Standard Package	Package Wt. lbs.
6798RT	Uses 3 square feet, 70" tall, holds your choice of Series 160 Rototower™ 16 ea C26P or U45P.	1	33.0

NOTE: Cabinets not included.

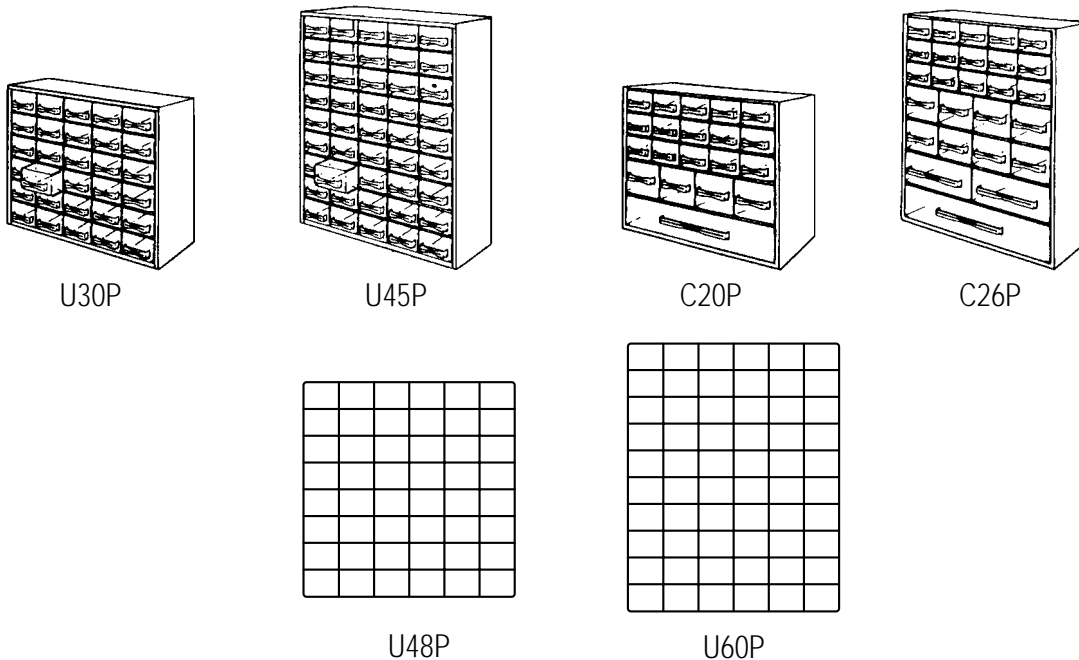



# Medical Products

Flambeau has an extensive line of medical packaging for emergency, clinical and custom OEM applications. Our EMS boxes, medical chests and instrument boxes come in a wide variety of styles, sizes and configurations to suit your needs. Whether it is Blow Molded or injection molded, the medical provider can select from standard items, custom products or modified standard items to meet application requirements.







## The Ultimate Drug Kit Paramedic Box or First Aid Box!



**NEW**

The NEW PM8040 is our most complete medical storage case yet! This case gives you the flexibility of bulk storage and compartmentalization to suit your needs.

### Features

- Manufactured from rustproof, dentproof and chemical resistant co-polymer resins.
- Includes (4) T6004 Tuff Tainers and (2) T2003 Tuff Tainers.
- Bulk storage compartment measures 18" across x 11" wide x 4" deep, includes slots to hold up to six (6) additional T2003 Tuff Tainers.
- Brass pin hinges and Cam-over latch design.
- Heavy duty handle.
- Exterior rack for additional storage.
- Quick access 5 compartment tray molded into the lid.

Model Number	L x W x D	Pack Per Ctn.
PM8040	20-1/2 x 12 x 14-1/2	2





## Drug Kits, Paramedic Boxes



Model PM2272 and PM2273

- 2- or 3-drawer styles.
- Drawers are removable and interchangeable.
- Non-slip rubber feet.
- Deep, easily accessible storage bin.
- Can be padlocked or sealed.

Model PM2072

- The standard in emergency care cases.
- Two tip-proof trays—2 inches deep.
- 11 compartments.
- Can be padlocked or sealed.

Model Number	L x W x D	Standard Drawers	Number of Compts.	Pack Per Ctn.
PM2072	19 x 10-3/4 x 10-1/8	N/A	11	1
PM2272	19-1/2 x 11-1/2 x 11-3/4	1-B, 1-C	8-14	1
PM2273	19-1/2 x 11-1/2 x 11-3/4	3-B	21-39	1



## First Aid Boxes

- 3 popular styles.
- PM1702 features removable tray - great for bulk supplies.
- PM1772 features 8 large compartments - ideal for bandages and larger items.
- PM1872 features 2 tip-proof trays, 9 compartments.

Model Number	L x W x D	Number of Compts.	Pack Per Ctn.
PM1702	16-1/2 x 8-3/4, x 7-1/2	2	4
PM1772	16-1/2 x 8-3/4, x 7-1/2	8	4
PM1872	17-5/8 x 10-1/4, x 8-3/4	9	4



## Drawer Cabinets



- 3 standard models - 4 to 6 drawers.
- Drawers are removable and interchangeable.
- Non-slip rubber feet.
- Can be padlocked or sealed.
- PM2275 is orange/white.

Model Number	L x W x D	Standard Drawers	Number of Compts.	Pack Per Ctn.
PM2274	19-1/2 x 10-3/8 x 15	1-A, 1-C, 1-D, 1-E	27	1
PM2275	19-1/2 x 10-3/8 x 15	2-A, 2-B, 1-D	53-65	1
PM2276	19-1/2 x 10-3/8 x 15	1-A, 3-B, 1-C, 1-E	47-65	1



## Instrument Boxes

- 5 standard sizes.
- Ideal for small or delicate equipment.
- Durable polypropylene construction.
- Safe for autoclaves.

Model Number	L x W x D	Standard Colors	Number of Compts.	Pack Per Ctn.
V301	7 -1/4 x 3-1/2 x 1-1/8	Orange	1	36
V401	8-3/8 x 4-1/2 x 1-11/16	Sand	1	24
V501	10-3/8 x 4-1/2 x 1-11/16	Sand	1	24
V601	14 x 6-1/4 x 2-1/2	Sand	1	12
V701	17-1/2 x 7-3/4 x 2-3/8	Sand	1	6





## Test Tube Storage

- 2 standard sizes.
- Translucent material for easy content identification.
- Lift-off lids.

Model Number	L x W x D	Max Tube O.D. x L	Number of Compts.	Pack Per Ctn.
5212TT	119mm x 62mm x 43mm	10mm x 40mm	50	24
5213TT	142mm x 75mm x 33mm	12mm x 30mm	50	24



### Complete Custom Capabilities

Custom cases add convenience to your medical organization. For original equipment manufacturers, custom cases convey a high quality, high-value message to your customers. Flambeau Packaging Solutions offers the finest in custom/OEM Blow Molded and injection molded plastic products for packaging, handling and storage applications.

### Stock Boxes & Cases

Choose from our established line of medical storage solutions or customize to fit your organizational needs.

### Blow Molded Cases

Provide impact protection, long-life durability and exact part placement. Flambeau has over 200 stock Blow Molded cases to fit your storage needs. If one of our stock cases is not a practical solution, we offer semi- and full-custom cases to fit your specifications.

Flambeau features full in-house computer-aided design and tooling. If you need more information or a custom quotation, please contact our Customer Services Department at (800) 344-5716. Minimum order requirements and tooling charges may apply. Dimensions are nominal.

# Conductive Products



Flambeau's line of conductive cases, cabinets, storage boxes and bins are the industry standard for the protection and safe handling of static sensitive components. Flambeau offers a wide variety of sizes and styles that are easily configured to meet your needs. Our Conductive Storage products are manufactured to a  $10^5\Omega/\text{in}^2$  or better volume resistance specification.





## Injection Molded Boxes...

Conductive boxes are available in single-compartment and multi-compartment styles. These carbon filled hi-impact plastic boxes are ideal for storage and transportation of static-sensitive parts.

Flambeau's conductive cabinets are built in accordance with the guidelines of DOD-HDT3K-263 to bleed off any static charge at a safe controlled rate when properly connected to a ground. Each cabinet comes with a static-safe ground wire which protects users against electrical shock. If the cabinet is on a table which is electrically conductive or grounded, the cabinet ground wire may be left off. Two series of cabinets are available: Plastic frame and metal frame.

Meets:

- ASTM Standard D257 for Volume and Surface Resistivity.
- MIL B81705 for Static Decay.

## Blow Molded Cases...

Especially designed for handling ESD sensitive components. Electronic components, unterminated printed circuit boards and entire assembled systems are all sensitive to electrostatic discharges (ESD). These discharges can result in immediate or latent damage to today's highly complex micro circuits. Proper handling, shipping and storage procedures for sensitive electronic components must be used to guard against expensive damage.

- Faraday Cage Protection.
- Double Wall Product Protection.
- Optional Foam Lining Protects from Static Discharge.
- Reusable.
- Proven Static Control.
- Conductive:  $< 10^9$  ohms per square inch.
- Anti-static:  $10^9$  to  $10^{13}$  ohms per square inch.

### OPTIONS

- Grounding Snap.
- Clear Conductive Window.





# Conductive Cases and Storage Systems Spec Sheet

## 14800-2C Conductive Storage Box

Box Number	Dimensions L x W x D	Description	Standard Package	Package Wt. lbs.
14800-2C	14-1/2 x 7-1/2 x 5-1/4	14" Storage Box w/ full length tray	6	11.0

## Conductive Boxes

Series Number	Box Number	Dimensions L x W x D	Compartments	Number of Package	Standard Package Wt. lbs.
600	C601	11 x 6-3/4 x 1-3/4	1	24	24.5
	C618	11 x 6-3/4 x 1-3/4	18	24	30.7
800	C801	13-1/8 x 9 x 2-5/16	1	12	21.6
	C824	13-1/8 x 9 x 2-5/16	24	12	26.0

## Conductive Storage Cabinets - Rototower™

Product No./ Part No.	Description	Cabinets	Number of Cabinets	Std. Package	Package Wt. lbs.
6797RT 161CRT	Uses 3 sq. ft., 70" tall	C26P-C; U45P-C	16*	1	33.0

\*Holds your choice of 16 ea. C26P-C or U45P-C Cabinets sold separately

## Plastic Frame Conductive Storage Cabinets

Model	Cabinet Size L x W x D	Drawers	Number of Drawer Type	Number	Std. Package	Standard Package Wt. lbs.
C20P-C	11-1/4 x 12 x 6	15	TW-C	35/52C	4	16.0
		4	TQ-C	N/A		
		1	TF-C	57/135C		
C26P-C	16-1/2 x 12 x 6	15	TW-C	35/52C	4	22.0
		8	TQ-C	N/A		
		2	TJ-C	57/135C		
		1	TF-C	57/135C		
U30P-C	11-1/4 x 12 x 6	30	TW-C	35/52C	4	16.0
U45P-C	16-1/2 x 12 x 6	45	TW-C	35/52C	4	22.0
U48P-C	14 x 11-1/2 x 22-1/2	48			4	3.9

# Conductive Cases and Storage Systems Spec Sheet

## Conductive Drawers (Plastic frame cabinets)

Drawer	Dimensions	Divider
TW-C	1-3/8 x 2 x 5-5/16	35/52C
TQ-C	2-1/4 x 2-1/2 x 5-5/16	N/A
TJ-C	2-1/4 x 5-5/16 x 5-5/16	57/135C
TF-C	2-1/4 x 11 x 5-5/16	57/135C

Not for sale as separate items

## Conductive Dividers (Plastic frame cabinets)

Divider	Dimensions	Fits Drawer	Standard Package	Package Wt. oz.
35/52C	1-3/16 x 2	TW-C	242	.0
57/135C	2-1/4 x 5-5/16	TF-C, TJ-C	12	5.0

## Conductive Bin Desk Stand with Bins

Stand	Dimensions	Bins	Number of Bin	Package	Standard Package Wt. lbs.
3100C	17-3/8 x 20-1/2 x 8-1/2	8	3006C	1	9.0
		4	3007C		
		4	3008C		

## Storage Bins

Bin No.	Overall Dimensions A x B x C	Color	Standard Package	Package Wt. lbs.
3006C	4-7/8 x 2 x 5-1/8	Black	24	4
3007C	4-7/8 x 3 x 6-5/8	Black	24	6
3008C	4-7/8 x 3-7/8 x 8-7/8	Black	12	4.7
3005C	4-7/8 x 5-7/8 x 12	Black	12	9.7

## Conductive Bin Desk Stand without Bins

Stand	Dimensions	Bins	Number of Package	Standard Package Wt. lbs.
3009C	17-3/8 x 20-1/2 x 8-1/2	Bins not included	1	7.0

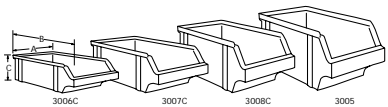
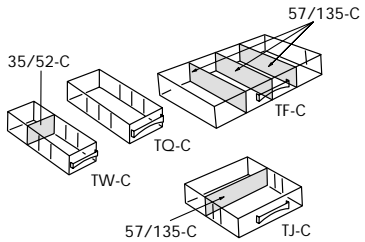

# Packaging Solutions

Flambeau will customize our proprietary line of stock boxes and cases with your name or logo. We can create a full custom solution too. Our in-house design and mold manufacturing team can go from "art to part" providing you the best packaging solution.

#### CUSTOMIZATION:

- Increases Sales
- Creates Brand Awareness
- Improves Point of Purchase Presentation
- Provides Value Added Product Protection

#### OPTIONS INCLUDE:

- Spectra Molding - see page 16 for details
- Custom Interior: Provides Exact Part Placement
- Hot Stamping
- Color Matched Resins
- Foam Inserts

Call us at 1-800-344-5716 to understand all the capabilities we can provide for you.



## Injected Molded Box Design

**There are many ways an injection molded box or case can be modified to fill the specific presentation need for your market. This section addresses specific details concerning common ways of customizing a package to become a more effective marketing tool.**

### Labels

Labels can often be used to add color and attractiveness to a package. The following helpful hints should make your labeling more efficient.

- Apply labels at ambient temperature. Plastics expand and contract with temperature changes at different rates. This will minimize label deformations caused by temperature changes.
- Make sure your label printer knows the plastic the label will be applied to so they will use the correct adhesive.
- As the label becomes larger, the paper needs to become stiffer for ease of application.
- Labels for areas that are not recessed should be 0.001" shorter (per side) than the identified area for best appearance.
- Labels for recessed areas should be 0.003" shorter (per side) than the recess area for ease of application.

### Hot Stamping

Hot stamping is the most common and economical way of getting your custom identification onto any injection molded product. A hot stamp generally consists of one color.

- A hot stamp of a smooth surface will be fairly sharp and smooth. A hot stamp on a textured surface will not be smooth or as sharp.
- Hot stamping large solid surfaces should be avoided. These types of hot stamps are subject to additional yield loss due to issues with bubbles and coverage.
- Hot stamping of finely detailed surfaces is extremely difficult. If you require a lot of fine detail you should consider pad printing.
- Multiple colors are possible with hot stamping and they have special requirements. Contact Customer Services for details and a specialized quotation.
- Hot stamping is not available on Blow Molded protective cases.





### **Pad Printing**

Pad printing is an excellent way of producing very sharp images on smooth surfaces. Not available on Blow Molded protective cases.

### **Custom Cores for Injection Molded Products**

Custom cores can be made for every product Flambeau manufactures. Custom cores are manufactured differently for different products. Exact details are required for a specialized quotation. This can be an excellent long term low cost solution for high volume products when compared to foam filled or thermoformed inserts.

### **Custom Interiors for Blow Molded Cases**

The individual piece part fit with these cases comes from making a custom interior. Depending on your parts, and how they need to be laid out in the case, you may require only a custom interior base. As your requirements increase, there may also be a custom interior lid, custom doors or trays, or a variety of other operations. Flambeau's design engineers will help you determine the most efficient case to meet your objectives

### **Custom Colors**

Flambeau offers 12 standard colors to help minimize the cost component. Flambeau also manufactures products from hundreds of custom colors. A custom color will be very close to the color you specified. To the human eye, the same color can appear to be different for all the following reasons.

- The same pigment can result in different colors on different resins.
- A smooth surface and any slightly textured surface will look different.
- The same item can appear as a different shade under different light (sunlight, incandescent light, and fluorescent light).
- An exact color match is exceedingly difficult and expensive.

**Latches** - see page 20

**Handles** - see page 20

### **Shipping Containers and Instructions**



## Blow Molded Case Design



FIXED



REMOVABLE

### How Do I...

#### 1. Select Lid and Base Depths?

The base should be equal to or greater than the depth of the lid. Try not to use a base depth more than three times the lid depth as that will substantially increase your cost.

#### 2. Select a Fixed or a Removable Pin Hinge?

You would want a removable hinge if you have one or more of the following.

- The base will be used as a tray, possibly in a drawer.
- The actual item needs visibility in retail display.
- The lid and base are both employed as trays in actual use.
- The use of the product is easier if the lid is removed. Otherwise, select a fixed pin hinge.

### The Ten Best Rules of Designing Blow Molded Cases

1. Lay out parts so that no part is too close to another part.
  - For PK and smaller use 0.375"
  - For PV use 0.500" between cavities
  - For PW and larger use 1.00" between cavities
2. Make sure no part touches another part.
3. Specify preferred placement of the parts – this may include ease of use for your customer.
4. Make sure the center of gravity is located near the center of hinge side. Very heavy parts should be near the center of the hinge side with lighter parts toward the outside.
5. If parts have a large difference in height choose one of the following:
  - Put small parts to the edges and deep parts toward the center.
  - Put small parts on one side and large parts on the other side.
6. By planning ahead, it is often possible to combine several models or sets into a single Blow Molded case. Let Flambeau help you do this.
7. If there are a lot of very small parts (e.g. <0.25" sockets) and one or more larger parts, a general storage area may be best for the small parts.
8. Sometimes a deeper case is more cost effective than one of greater length and width. Simply rotate the parts and try again. Make sure the depth is not more than one half the length of the part. Also consider holding parts in the lid with a door or detents.
9. Blow molding does not demand the tolerance of injection molding. Nominal tolerances are 0.0625 per foot for a length of over 6 inches and 0.030 for under 6 inches.
10. Call Flambeau at 1-800-344-5716.



# Request For Quote

Date \_\_\_\_\_ Project # \_\_\_\_\_  
 Quotation Requested: Rough \_\_\_\_\_ Formal \_\_\_\_\_  
 Quote By (Date) \_\_\_\_\_ Actual Estimated Annual Volume \_\_\_\_\_ Value Range \_\_\_\_\_  
 \$ \_\_\_\_\_

## Customer Information

Customer \_\_\_\_\_ Contact \_\_\_\_\_ Title \_\_\_\_\_  
 Address \_\_\_\_\_  
 Phone \_\_\_\_\_ FAX# \_\_\_\_\_ E-Mail \_\_\_\_\_  
 Customer Design/Eng. Contact Name: \_\_\_\_\_  
 Phone \_\_\_\_\_ FAX# \_\_\_\_\_ E-Mail \_\_\_\_\_  
 Sales Rep. \_\_\_\_\_ Territory # \_\_\_\_\_  
 1st Production Date Due and Quantity to be Run \_\_\_\_\_

## Description of Product to be Packaged

What Is It? \_\_\_\_\_  
 What Does It Do? \_\_\_\_\_  
 Who Uses It? \_\_\_\_\_  
 Environment To Be Used? \_\_\_\_\_  
 New Or Existing Part? \_\_\_\_\_  
 Weight Of Product? \_\_\_\_\_  
 O.A. Requirements \_\_\_\_\_  
 Drop Test Requirements \_\_\_\_\_  
 Customer To Provide: Drawings: Y  N  Prototype Parts: Y  N   
 Date Received \_\_\_\_\_ Actual Parts: Y  N  Literature: Y  N   
 How Is Product Currently Packaged \_\_\_\_\_  
 Is Existing B.M. Tooling Available Y  N  Describe \_\_\_\_\_

## Case Description

Est. Case Size: \_\_\_\_\_ x \_\_\_\_\_ x \_\_\_\_\_ Type: Stock - Semi-Custom - Custom  
 Handle: Fold Down \_\_\_\_\_ Integral \_\_\_\_\_ None \_\_\_\_\_  
 Latch(es): Integral \_\_\_\_\_ NJ.Molded \_\_\_\_\_ Metal \_\_\_\_\_ Locking \_\_\_\_\_  
 Hinge: Integral \_\_\_\_\_ P-Series Pin \_\_\_\_\_ PF Pin \_\_\_\_\_ Metal \_\_\_\_\_  
 Foam: Y  N  Description \_\_\_\_\_

# Request For Quote

## Blow Molded Cases

### Case Descriptions

Est. Case Size: \_\_\_\_\_ x \_\_\_\_\_ x \_\_\_\_\_ Type:  Stock  Customized Stock  Custom

Handle:  Fold Down  Integral  None \_\_\_\_\_

Latches:  Integral  Inj. Molded \_\_\_\_\_  Metal \_\_\_\_\_  Locking \_\_\_\_\_

Hinge:  Integral  P-Series Pin \_\_\_\_\_  PF Pin \_\_\_\_\_  Metal \_\_\_\_\_

Foam:  Y  N  Description \_\_\_\_\_

Label/Logo (4-7/8 X 1-7/8)  (3-1/4 X 1-1/2)  (Outside Lid Plate)  (Custom)

Camera Ready Artwork:  Y  N

Part Numbers Interior:  Y  N  Engraved \_\_\_\_\_ Etched Slugs \_\_\_\_\_

Stacking Features Required:  Y  N  Interior Panels/Doors:  Y  N  Snap/Fasteners:  Y  N

Take Apart Hinge:  Y  N  Literature Clip:  Y  N

Other \_\_\_\_\_

Color: \_\_\_\_\_ PMS# \_\_\_\_\_ Must Color Be Matched?  Y  N

Case Function: Storage  Display  Shipper \_\_\_\_\_

Consumer  Industrial

Texture Requirements \_\_\_\_\_

## Complete For All Cases

### Material Requirements

HDPE  Co-Polymer  Homopolymer  H.M.W. \_\_\_\_\_ UV Stab. \_\_\_\_\_

Styrene \_\_\_\_\_ K-Resin® \_\_\_\_\_ Polypropylene \_\_\_\_\_

Conductive:  Single Layer  CO/EX \_\_\_\_\_ UL Requirements:  V0,  V1,  V2,  V5,  94 HB

Other Describe: \_\_\_\_\_

### Package Requirements

Standard Bulk Carton:  Y  N  # Per/Ctn \_\_\_\_\_ Custom Carton:  Y  N  # Per/Ctn \_\_\_\_\_

Customer Requested Carton: Size \_\_\_\_\_ x \_\_\_\_\_ x \_\_\_\_\_

Customer Part Number: \_\_\_\_\_ On Invoice?:  Y  N  On Cartons?  Y  N

Master Carton:  Y  N  # Indiv/Ctns. \_\_\_\_\_

Print:  Y  N  # Panels \_\_\_\_\_ Colors (s) \_\_\_\_\_ Artwork \_\_\_\_\_

Gaylord:  Y  N  Size Requirements \_\_\_\_\_ Polybag Liner:  Y  N

Pallet:  Y  N  Pallet Size: \_\_\_\_\_ Band:  Y  N  Stretch Wrap:  Y  N

Max. Size of Pallet Load L \_\_\_\_\_ W \_\_\_\_\_ H \_\_\_\_\_ Double Stack:  Y  N

Other Comments \_\_\_\_\_

Model No./Description	Page No.	Model No./Description	Page No.	Model No./Description	Page No.
10 x 8 Conductive Case	5	3030-2 Compartmented Box	10, 29	A213-SL Compartmented Box	37
1016-2 Large Compartmented Case	53	3030C Metal Frame Conductive Storage Cabinet	65	A214 Compartmented Box	31
1021-2 Large Compartmented Case	53	3048C Metal Frame Conductive Storage Cabinet	65	A215 Compartmented Box	33
1024-2 Large Compartmented Case	53	3060C Metal Frame Conductive Storage Cabinet	65	A216 Compartmented Box	30
1032-2 Large Compartmented Case	53	3080C Metal Frame Conductive Storage Cabinet	65	A216-SL Compartmented Box	30
1100 Utility Box	7, 46	3100C Conductive Bin Desk Stand w/Bins	66	A217 Compartmented Box	35
11090-2 Utility Box w/Cantilever Trays	47	35/52C Conductive Divider (Metal Frame Cabinet)	66	A219 Compartmented Box	38
12 x 12 Conductive Case	5	35/52C Conductive Divider (Plastic Frame Cabinet)	66	A220 Compartmented Box	34
12 x 8 Conductive Case	5	35/64C Conductive Divider (Metal Frame Cabinet)	66	A221 Compartmented Box	32
1200 Utility Box	7, 46	350BT Bin Rototower™	55	A226 Compartmented Box	30
120B Bin	55	351BA Bin	55	A228 Compartmented Box	36
120R Bin	55	4040-2 Compartmented Box	10, 29	A250 Compartmented Box	30
120Y Bin	55	480B Bin	55	A401 Compartmented Box	30
13 x 11 Conductive Case	5	480R Bin	55	A601 Compartmented Box	30
13900-2 Expandable Building Box	49	480Y Bin	55	A601D Compartmented Box	30
13901-2 Expandable Building Box	49	5 x 3 Conductive Case	5	A602 Compartmented Box	38
1400 Utility Box	7, 46	50 BTR Bin Desk Stand	55	A603 Compartmented Box	31
14800-2 Utility Box w/Lift-Out Trays	7, 46	5126CL Compartmented Box	39	A606 Compartmented Box	34
14800-2C Conductive Storage Box	65	5127CL Compartmented Box	37	A606D Compartmented Box	34
15 x 11 Conductive Case	5	5128CL Compartmented Box	34	A607 Compartmented Box	35
15 x 6 Conductive Case	5	5129CL Compartmented Box	41	A612 Compartmented Box	38
151CRT Metal Conductive Storage Cabinet - Rototower™	65	5130CL Compartmented Box	34	A612D Compartmented Box	38
160RT - Rototower™	57	5200CL Compartmented Box	30	A613 Compartmented Box	39
161CRT Conductive Storage Cabinet - Rototower™	65	5202CL Compartmented Box	31	A618 Compartmented Box	40
16500-2 Utility Tote	48	5204CL Compartmented Box	32	A618D Compartmented Box	40
1700 Utility Box	7, 46	5206CL Compartmented Box	34	A623 Compartmented Box	39
17090-2 Utility Box w/Cantilever Trays	47	5212TT Test Tube Storage	62	A701 Compartmented Box	30
17800-2 Utility Box w/Lift-Out Trays	7, 46	5213TT Test Tube Storage	62	A801 Compartmented Box	30
18 x 18 Conductive Case	5	57/135C Conductive Divider (Metal Frame Cabinet)	66	A806 Compartmented Box	34
18 x 4 Conductive Case	5	57/135C Conductive Divider (Plastic Frame Cabinet)	66	A812 Compartmented Box	38
1800 Utility Box	7, 46	57/87C Conductive Divider (Metal Frame Cabinet)	66	A818 Compartmented Box	40
18090-2 Utility Box w/Cantilever Trays	47	60B Bin	55	A824 Compartmented Box	41
18192-2 Expandable Building Box	49	60R Bin	55	A924-2 Compartmented Box	41
19060-2 Utility Box w/Cantilever Trays	47	60Y Bin	55	AC Conductive Drawer (Metal Frame Cabinet)	66
19800-2 Utility Box w/Lift-Out Trays	7, 46	6797RT Conductive Storage Cabinet - Rototower™	65	B210-SL Compartmented Box	35
20 x 14 Conductive Case	5	6798RT Series 160 Rototower™	57	B216-SL Compartmented Box	30
2020-2 Heavy-Duty Clear Precision Style Box	10, 29	6799RT Metal Conductive Storage Cabinet - Rototower™	65	C20P Plastic Frame Storage Cabinets	56
20220-2 Carry Pack	50	7 x 5 Conductive Case	5	C20P-C Plastic Frame Conductive Storage Cabinet	65
2040-2 Compartmented Box	29	711-2 Small Satchel-Style Compartmented Case	11, 54	C26P Plastic Frame Storage Cabinets	56
2100 Utility Box	7, 46	724-2 Small Satchel-Style Compartmented Case	11, 54	C26P-C Plastic Frame Conductive Storage Cabinet	65
21210-2 Carry Pack	50	725-2 Small Compartmented Case	54	C601 Conductive Box	65
21600-2 Carry Pack	50	748-2 Small Compartmented Case	54	C618 Conductive Box	65
21800-2 Bench Box	48	75 BWP Bin Wall Panel	55	C801 Conductive Box	65
22030 Drawer Cabinets & Chests	51	9 x 7 Conductive Case	5	C824 Conductive Box	65
22030-2 Drawer Cabinets & Chests	51	999-2 IDS Box	26	CC Conductive Drawer (Metal Frame Cabinet)	66
22060 Drawer Cabinets & Chests	51	999-2 IDS Box, Extra Dividers	26	Custom Capabilities	67
22500-3 Step 'N Store	49	A01 Compartmented Box	29	DB200 Diamondback™ Compartmented Box	9, 40
2275-2 Drawer Cabinets & Chests	51	A101 Compartmented Box	29	DB201 Diamondback™ Compartmented Box	9, 38
2276-2 Drawer Cabinets & Chests	51	A154 Compartmented Box	32	DB203 Diamondback™ Compartmented Box	9, 34
2277-2 Drawer Cabinets & Chests	51	A155 Compartmented Box	33	DB204 Diamondback™ Compartmented Box	9, 38
23800-2 Utility Box w/Lift-Out Trays	7, 46	A166-36 Compartmented Box	41	DB206 Diamondback™ Compartmented Box	9, 30
240B Bin	55	A200 Compartmented Box	40	DB208 Diamondback™ Compartmented Box	9, 38
240R Bin	55	A201 Compartmented Box	38	DB210 Diamondback™ Compartmented Box	9, 36
240Y Bin	55	A203 Compartmented Box	34	DB211 Diamondback™ Compartmented Box	9, 34
27800-2 Utility Box w/Lift-Out Trays	7, 46	A204 Compartmented Box	38	DB213 Diamondback™ Compartmented Box	9, 37
3000C Metal Frame Conductive Storage Cabinet	65	A206 Compartmented Box	29	DB216 Diamondback™ Compartmented Box	9, 30
3005C Storage Bin	66	A208 Compartmented Box	38	DB217 Diamondback™ Compartmented Box	9, 35
3006C Storage Bin	66	A209 Compartmented Box	36	DB219 Diamondback™ Compartmented Box	9, 38
3007C Storage Bin	66	A210 Compartmented Box	36	DB220 Diamondback™ Compartmented Box	9, 34
3008C Storage Bin	66	A210-SL Compartmented Box	36	DB221 Diamondback™ Compartmented Box	9, 32
3009C Conductive Bin Desk Stand without Bins	66	A211 Compartmented Box	34	DB226 Diamondback™ Compartmented Box	9, 30
3016C Metal Frame Conductive Storage Cabinet	65	A212 Compartmented Box	33	DB228 Diamondback™ Compartmented Box	9, 36
3024C Metal Frame Conductive Storage Cabinet	65	A213 Compartmented Box	37	DB601 Diamondback™ Compartmented Box	9, 30
				DB606 Diamondback™ Compartmented Box	9, 34

# PRODUCT INDEX BY MODEL NUMBER

Model No./Description	Page No.	Model No./Description	Page No.	Model No./Description	Page No.
DB613 Diamondback™ Compartmented Box	9, 39	M618D Compartmented Box	40	T602 Compartmented Box	38
DB618 Diamondback™ Compartmented Box	9, 40	M623 Compartmented Box	39	T606 Compartmented Box	34
Divider for Tailgator™	4	M806 Compartmented Box	34	T606D Compartmented Box	34
Expandable Tube	4	M808 Compartmented Box	36	T612 Compartmented Box	38
Extra Wide Locker Case	4	M812 Compartmented Box	38	T612D Compartmented Box	38
FC Conductive Drawer (Metal Frame Cabinet)	66	M818 Compartmented Box	40	T616R Compartmented Box	32-39
Handle, Latch & Additional Options for Protective Cases	20-21	M824 Compartmented Box	41	T618 Compartmented Box	40
How to Locate the Box You Need	28	Outside Dimensions, Compartmented Box	42-43	T618D Compartmented Box	40
IDS™ Cabinet w/5 Trays & 5 999-2 Boxes	26	PC 3-9/16	3	T623 Compartmented Box	39
IDS™ Cabinet w/5 Trays & 5 T-900 Boxes	26	PH 3-1/8	3	T806 Compartmented Box	34
IDS™ Cabinet w/5 Trays, No Boxes	26	Pin Hinge Cases	14-18	T824 Compartmented Box	41
Infinity™ 14	2, 13	PM1702 First Aid Box	60	T900 Compartmented Box	32-40
Infinity™ 17	2, 13	PM1772 First Aid Box	60	Tailgator™ (with Interior)	4
Infinity™ 20	2, 13	PM1872 First Aid Box	60	Tailgator™ (without Interior)	4
Integral Hinge Cases	14-18	PM2072 Drug Kit/Paramedic Box	60	TF-C Conductive Drawer (Plastic Frame Cabinet)	66
JC Conductive Drawer (Metal Frame Cabinet)	66	PM2272 Drug Kit/Paramedic Box	60	TJ-C Conductive Drawer (Plastic Frame Cabinet)	66
K166-36 Compartmented Box	41	PM2273 Drug Kit/Paramedic Box	60	TQ-C Conductive Drawer (Plastic Frame Cabinet)	66
K200 Compartmented Box	40	PM2274 Drawer Cabinet	61	Tradesman's Case	8
K201 Compartmented Box	38	PM2275 Drawer Cabinet	61	TW-C Conductive Drawer (Plastic Frame Cabinet)	66
K203 Compartmented Box	34	PM2276 Drawer Cabinet	61	U30P Plastic Frame Storage Cabinets	58
K206 K-Resin® Compartmented Box	10, 30	PM8040	59	U30P-C Plastic Frame Conductive Storage Cabinet	65
K208 Compartmented Box	38	PQ 3-7/8	3	U45P Plastic Frame Storage Cabinets	58
K210 Compartmented Box	36	PV 4	3	U45P-C Plastic Frame Conductive Storage Cabinet	65
K216 Compartmented Box	30	PV 5-1/8	3	Utility Workstation™	11, 45
K219 Compartmented Box	38	PW 4	3	V301PT Compartmented/Instrument Box	8, 30, 61
K220 Compartmented Box	34	PW 6-1/4	3	V305-2 Compartmented Box	33
K226 K-Resin® Compartmented Box	10, 30	PX 5	3	V305W-2 Compartmented Box	33
K601 K-Resin® Compartmented Box	10, 30	PX 8	3	V308-2 Compartmented Box	31
K601D Compartmented Box	30	PZ 4-1/2	3	V401 Compartmented/Instrument Box	8, 30, 58
K602 Compartmented Box	38	PZ 4-1/2	3	V401D-2 Compartmented Box	30
K606 Compartmented Box	34	PZ 8	3	V402-2 Compartmented Box	31
K606D Compartmented Box	34	RA 1-3/4 Conductive Case	5	V410-2 Compartmented Box	33
K607 Compartmented Box	35	Request for Quote	71	V501 Compartmented/Instrument Box	8, 30, 58
K612D Compartmented Box	38	Shelf for Tailgator™	4	V504W-2 Compartmented Box	32
K616R Compartmented Box	32-39	SR4 Bin Rail	55	V506-2 Compartmented Box	34
K618 Compartmented Box	40	T-300 IDS Box	26	V601 Compartmented/Instrument Box	8, 30, 58
K618D Compartmented Box	40	T-300 IDS Box, Extra Dividers	26	V701 Compartmented/Instrument Box	8, 30, 58
K623 Compartmented Box	39	T-600 IDS Box	26	VME 12 x 9 Conductive Case	5
K701 Compartmented Box	30	T-600 IDS Box, Extra Dividers	26	WC Conductive Drawer (Metal Frame Cabinet)	66
K801 K-Resin® Compartmented Box	10, 30	T-900 IDS Box	26	Work Center Fold™	4
K806 Compartmented Box	34	T-900 IDS Box, Extra Dividers	26		
K812 Compartmented Box	38	T155 Compartmented Box	33		
K818 Compartmented Box	40	T200 Compartmented Box	40		
K824 Compartmented Box	41	T2003 Tuff-Tainer Box w/5 Compartments & 15 Dividers	25, 29-38		
Large Locker Case	4	T2003 Tuff Tainer Box, Extra Dividers	27		
LC-4-Base for Large Compartmented Case	53	T201 Compartmented Box	38		
LS-1-Cabinet for Large Compartmented Case	53	T203 Compartmented Box	34		
Lil' Brute™ Toolbox	44	T210 Compartmented Box	36		
M200 Compartmented Box	40	T215 Compartmented Box	33		
M201 Compartmented Box	38	T219 Compartmented Box	38		
M203 Compartmented Box	34	T220 Compartmented Box	34		
M208 Compartmented Box	38	T221 Compartmented Box	32		
M210 Compartmented Box	36	T300 Compartmented Box	31		
M215 Compartmented Box	33	T3003 Tuff-Tainer Box w/3 Compartments & 15 Dividers	27		
M220 Compartmented Box	34	T3003 Tuff-Tainer Box, Extra Dividers	27		
M221 Compartmented Box	32	T4006 Tuff-Tainer Box w/6 Compartments & 12 Dividers	27, 31-40		
M602 Compartmented Box	38	T4006 Tuff-Tainer Box, Extra Dividers	27		
M606 Compartmented Box	34	T5004 Tuff-Tainer Box w/4 Compartments & 20 Dividers	27		
M606D Compartmented Box	34	T5004 Tuff-Tainer Box, Extra Dividers	27		
M612 Compartmented Box	38	T600 Compartmented Box	34-38		
M612D Compartmented Box	38				
M616R Compartmented Box	32-39				
M618 Compartmented Box	40				

## Flambeau Packaging Solutions Provides You With:

- Over 50 Years Experience.
- Largest Selection of Stock Cases.
- Extensive Design and Complete In-house Product Development.
- Hot Stamping, Pad Printing, Heat Transfer and Other Decorating Capabilities.
- In-house Tool Shops.
- Custom Injection and Blow Molding.
- Express Service Shipment within 24 Hours.
- Multiple Manufacturing Facilities.
- National Sales Coverage.
- Understanding Of, and Presence In, Industrial and Retail Markets.

## Flambeau's Product Offerings Include:

- Full Custom Capabilities.
- Blow Molded Protective Cases.
- Injection Molded Compartmented Boxes and Cases.
- Mobile Storage Systems.
- Stationary Storage Systems.
- Express Service Cases.
- Special Storage Products.
- Conductive Storage Products.
- Medical Cases.
- Tool Boxes and Utility Boxes.



1-800-344-5716

Customer Service  
 15981 Valplast Road  
 Middlefield, Ohio 44062  
 Phone: (800) 457-5252  
 Internet: [www.flambeau.com](http://www.flambeau.com)  
 (visit CMG)  
 Fax: (440) 632-1581



A Member of the Nordic Group of Companies  
[www.flambeau.com](http://www.flambeau.com)