

## Amphenol RJ45 Stackable

Reduces component and labour costs by incorporating LED's into the connector.

Meets Ethernet CAT 5 Performance

Stackable feature enables more ports with same board space.

For superior EMI performance, the option of configuring your connector with a ferrite filter is available.

Amphenol offers a wide variety of options:

- Ferrite filter
- Shielded & unshielded versions
- Variety of LED combinations
- Variety of ports



## Specifications

### MATERIAL

Please refer to RJHS specifications on page 1.

### ELECTRICAL

UL File #: E135615

CSA File #: 150190

## Impedance Characteristics

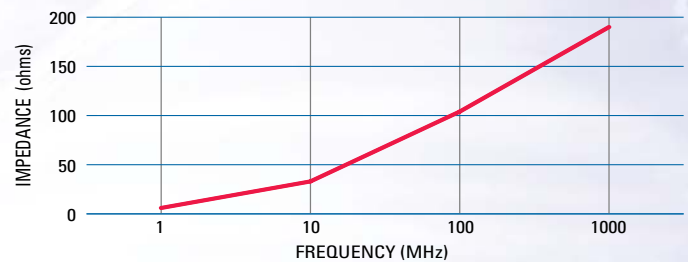

## Ordering Information

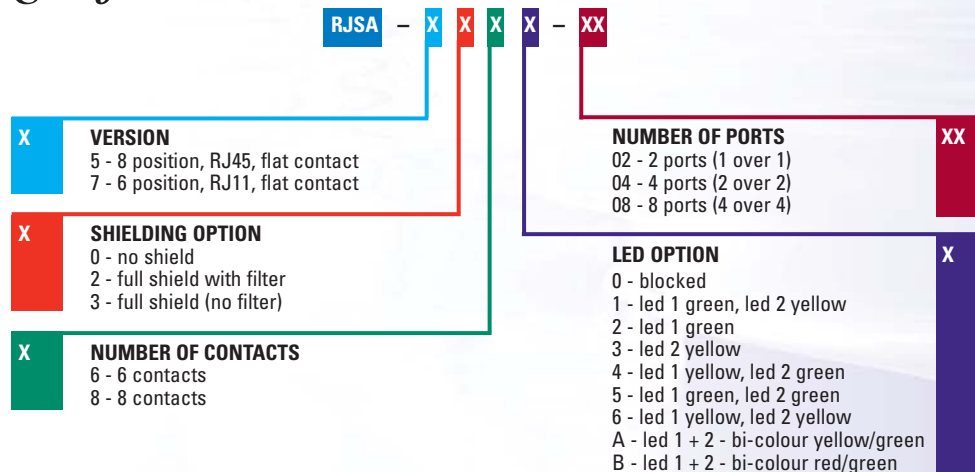

\* Filtering available - Please contact Amphenol for more information  
\*\* additional LED codes available - see page 2

# RJSA Series

STACKED RJ VISTA™

## 2x1 RJ45/RJ11

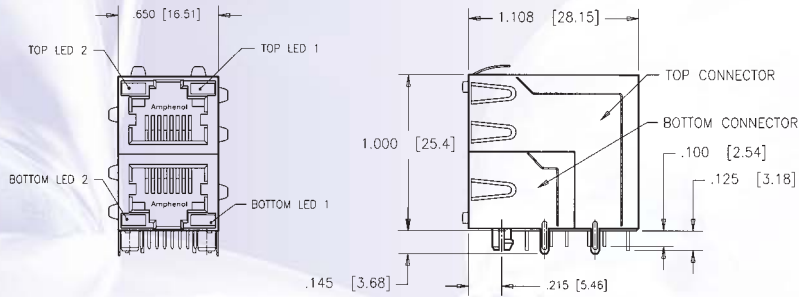

## PCB LAYOUT

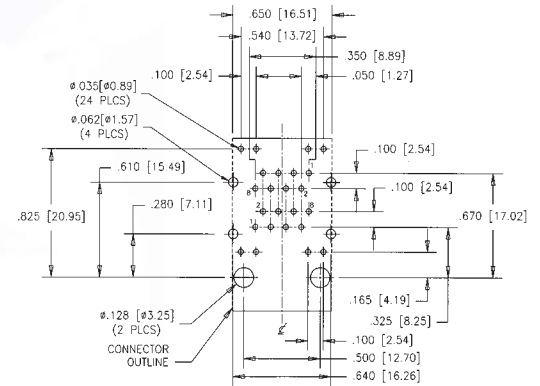

## 2X4 RJ45/RJ11

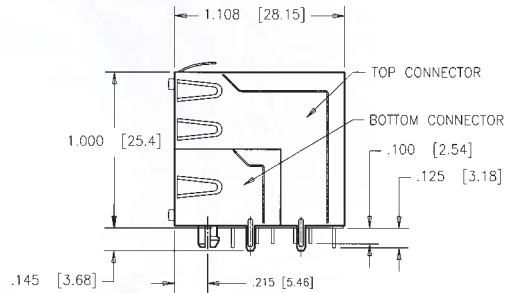
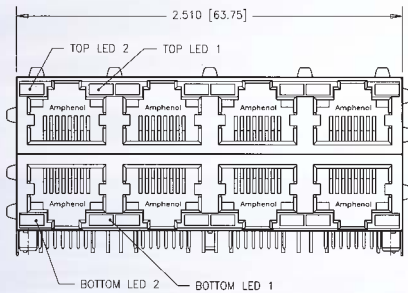

## PCB LAYOUT

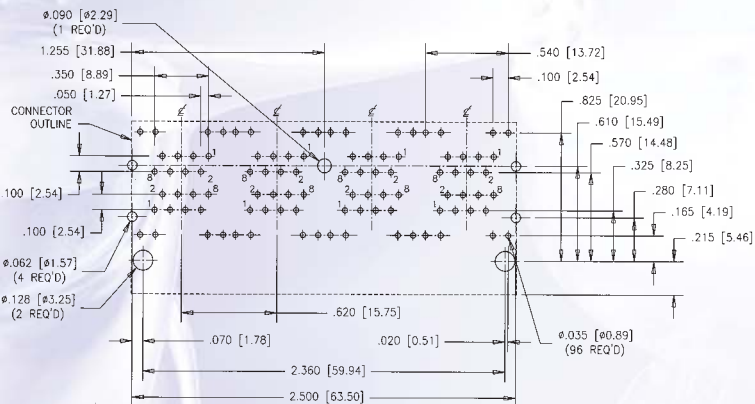

## ASSEMBLY

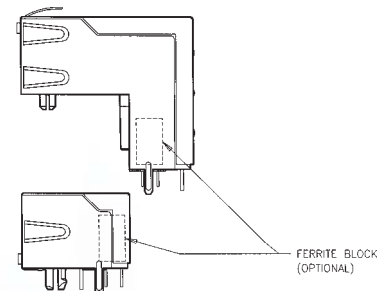

STACKABLE MODULAR JACK ASSEMBLY