

TINA-MX-6 lenses for CREE MX-6 LEDs



- Designed & optimized for Cree MX-6 series of LEDs
- Lens material optical grade PMMA with high UV and temperature resistance (105°C/220°F). Allows use of high current and temperature conditions
- Best available optical efficiency, over 90%, with an extremely good cutoff of light
- Fastening to heat sink with a PU foam adhesive tape of automotive grade (included)
- We advise customer to ensure the suitability and sufficiency of the bond in the end product. For example, mechanical stress, vibration and holes on the surface of the circuit board weaken the strength of the tape.
- Please check fastening details from this link:
(http://www.ledil.com/datasheets/DataSheet_TAPE.pdf)
- Compact dimensions 16.1 x 10.1 mm.

LENS TYPES

NAME	ORDERING CODE	FWHM Angle
Tina-MX-6 REAL SPOT	FA10888_Tina-MX6-RS	±11°
Tina-MX-6 DIFFUSER	FA10646_Tina-MX6-D	±11.5°
Tina-MX-6 MEDIUM	FA10647_Tina-MX6-M	±17°
Tina-MX-6 OVAL	FA11201_Tina-MX6-O	±N/A°
Tina-MX-6 WIDE	FA10839_Tina-MX6-W	±22°
Tina-MX-6 WW	FA10901_Tina-MX6-WW	±30°

© Ledil Oy – PRELIMINARY - Subject to change without prior notice

MEASUREMENTS

Relative Intensity of FA10888_Tina-MX6-RS

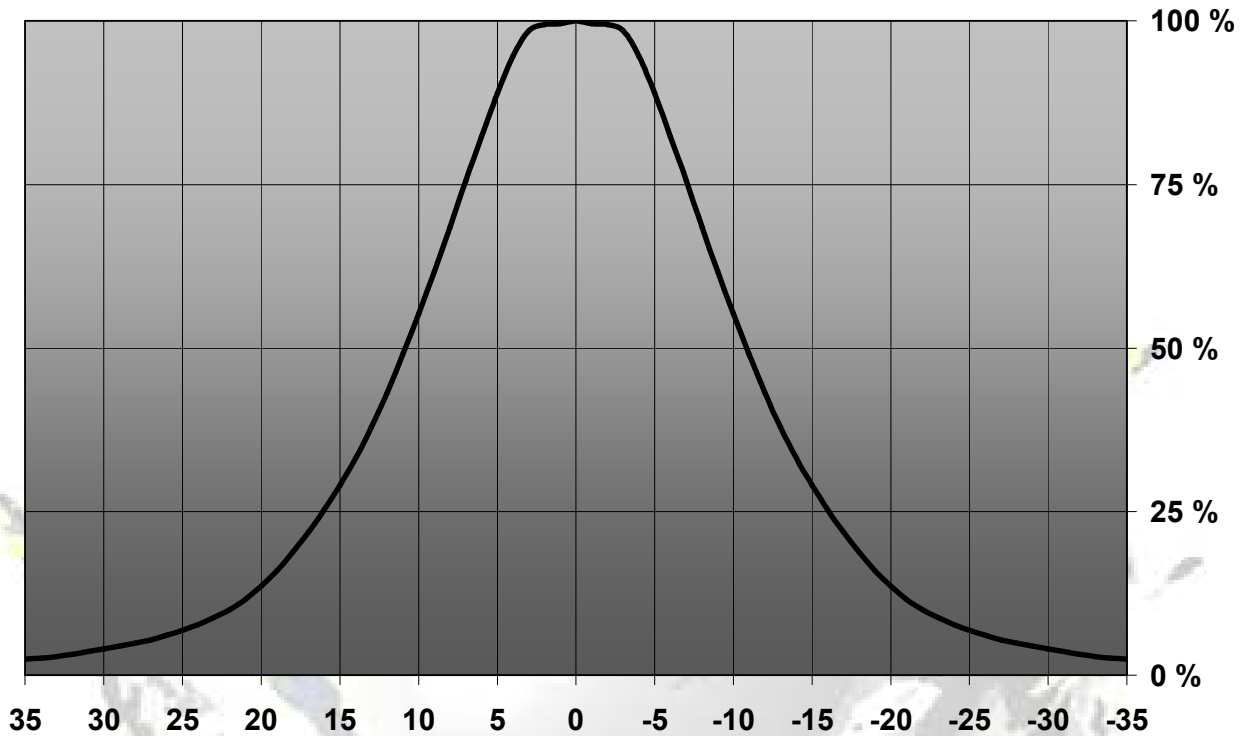

© Ledil Oy – PRELIMINARY - Subject to change without prior notice

Relative Intensity of FA10646_Tina-MX6-D

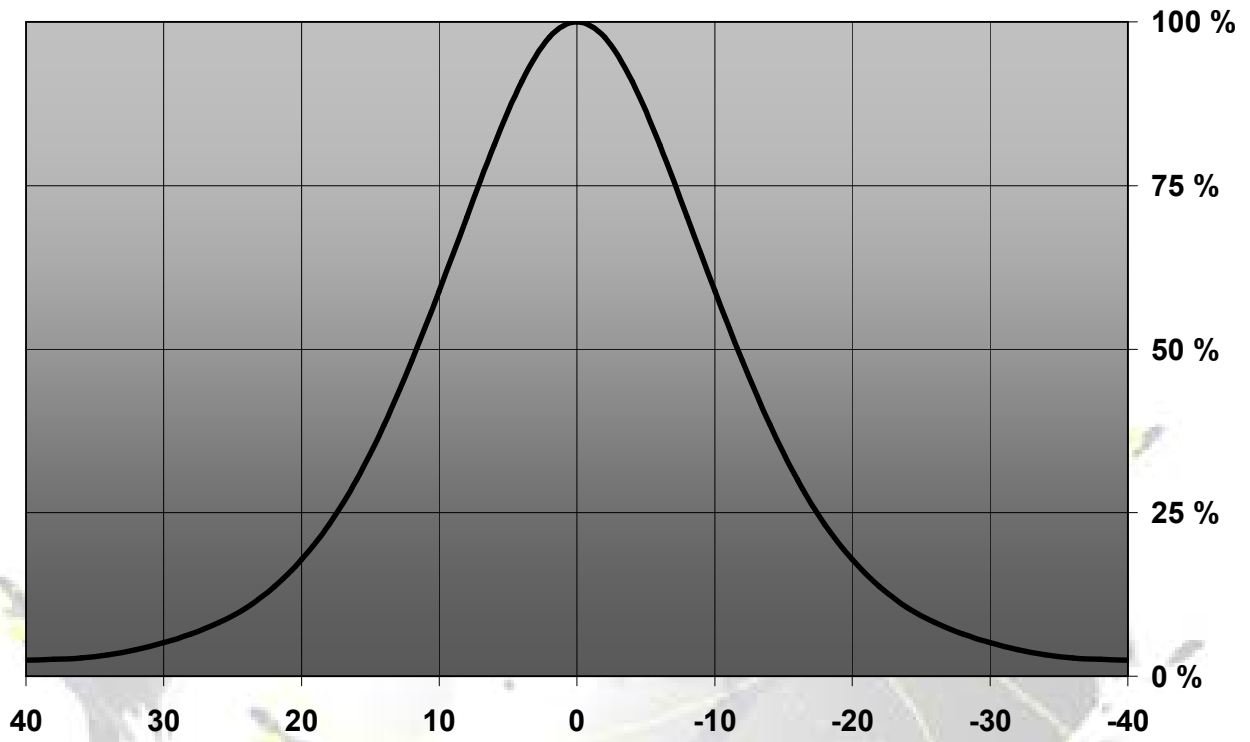

© Ledil Oy – PRELIMINARY - Subject to change without prior notice

Relative Intensity of FA10647_Tina-MX6-M

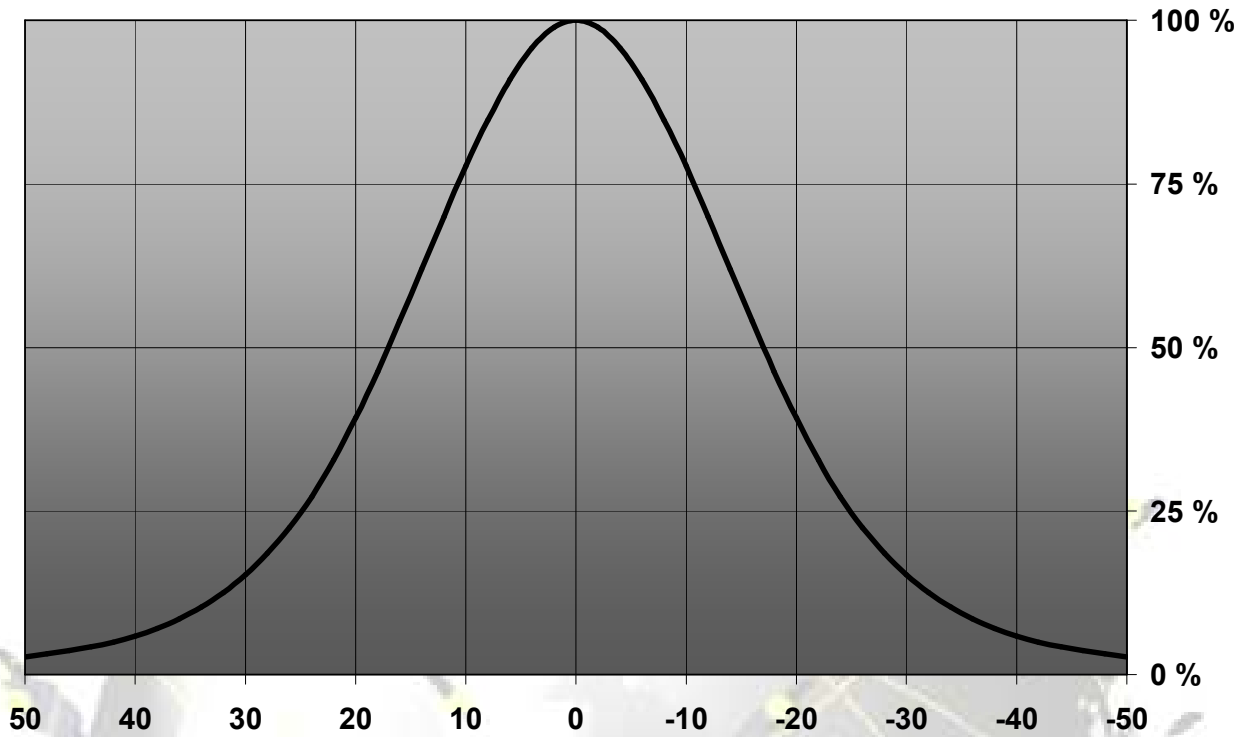

© Ledil Oy – PRELIMINARY - Subject to change without prior notice

Relative Intensity of FA10839_Tina-MX6-W

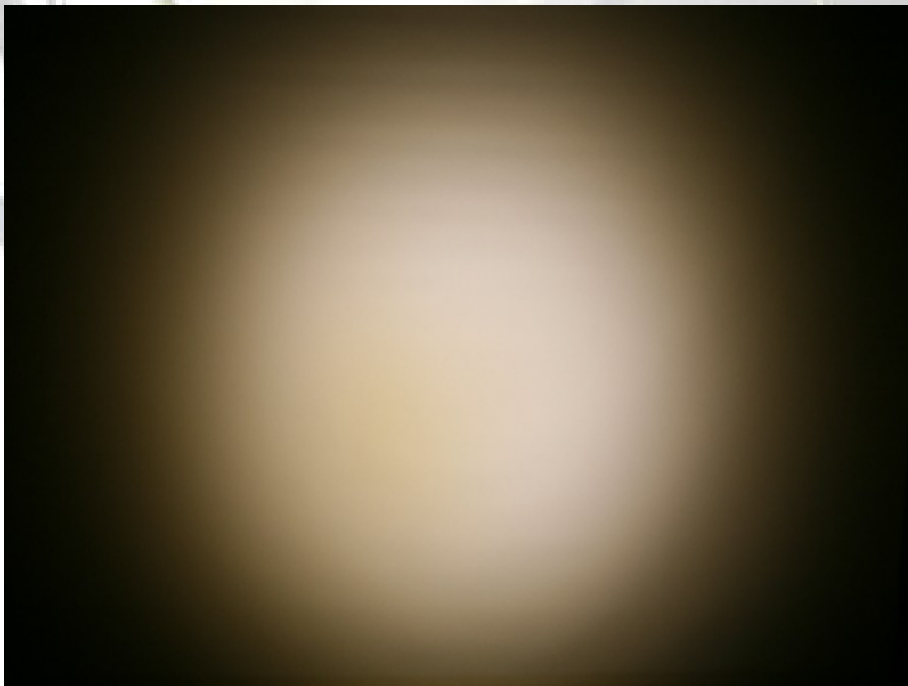
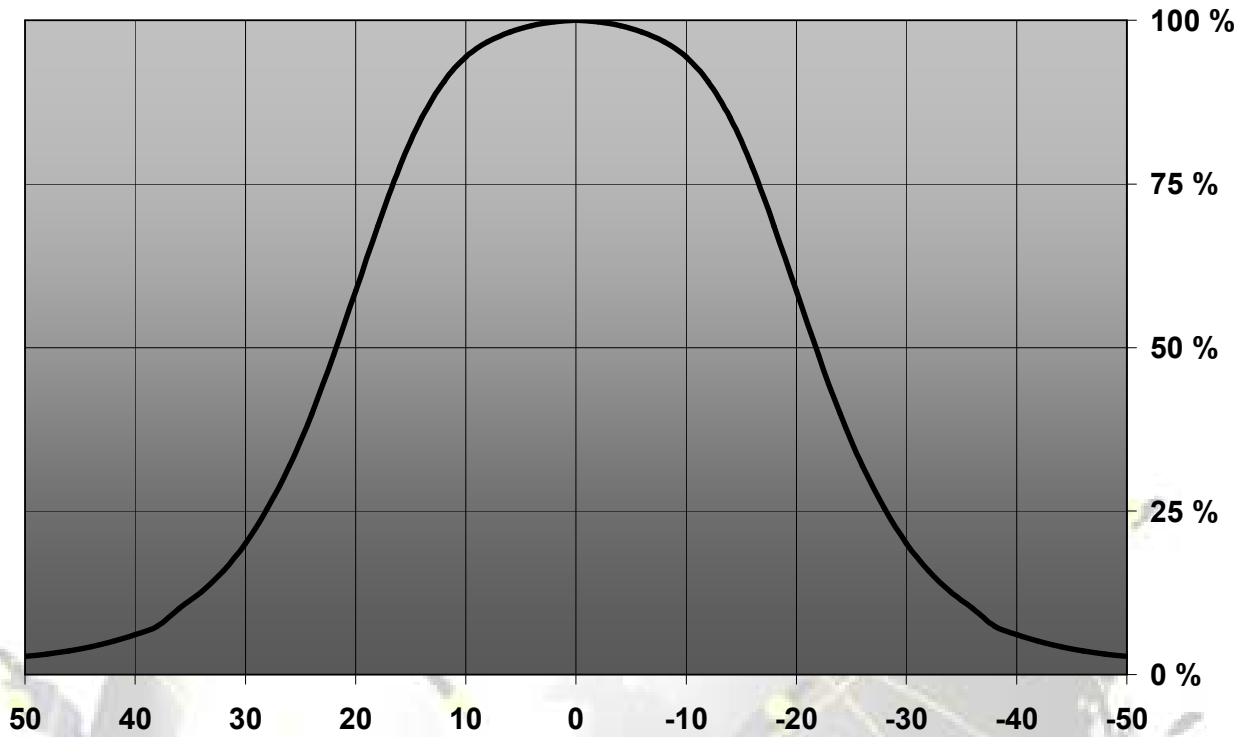

© Ledil Oy – PRELIMINARY - Subject to change without prior notice

Relative Intensity of FA10901_Tina-MX6-WW

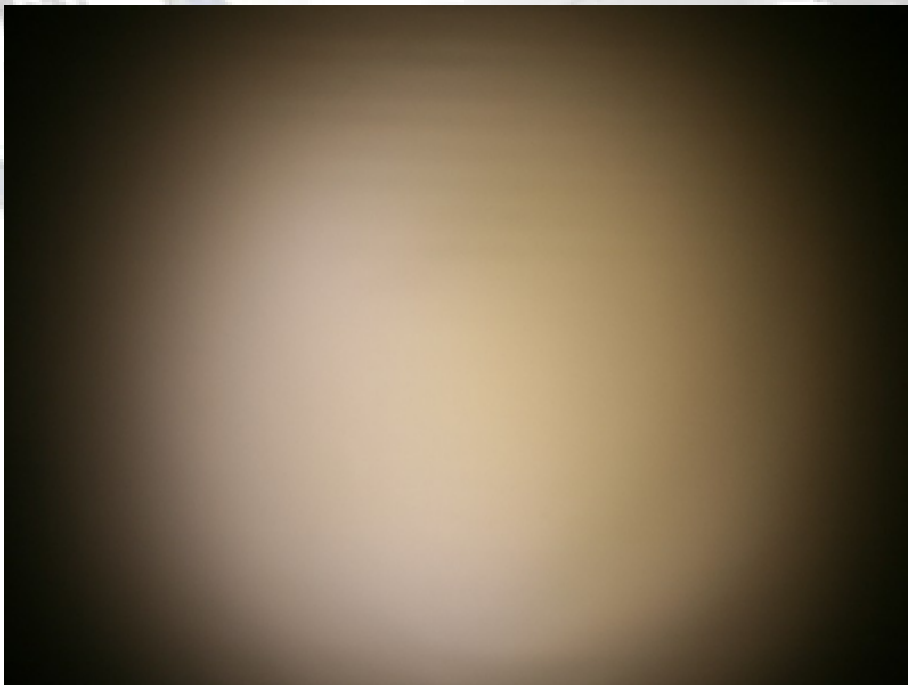
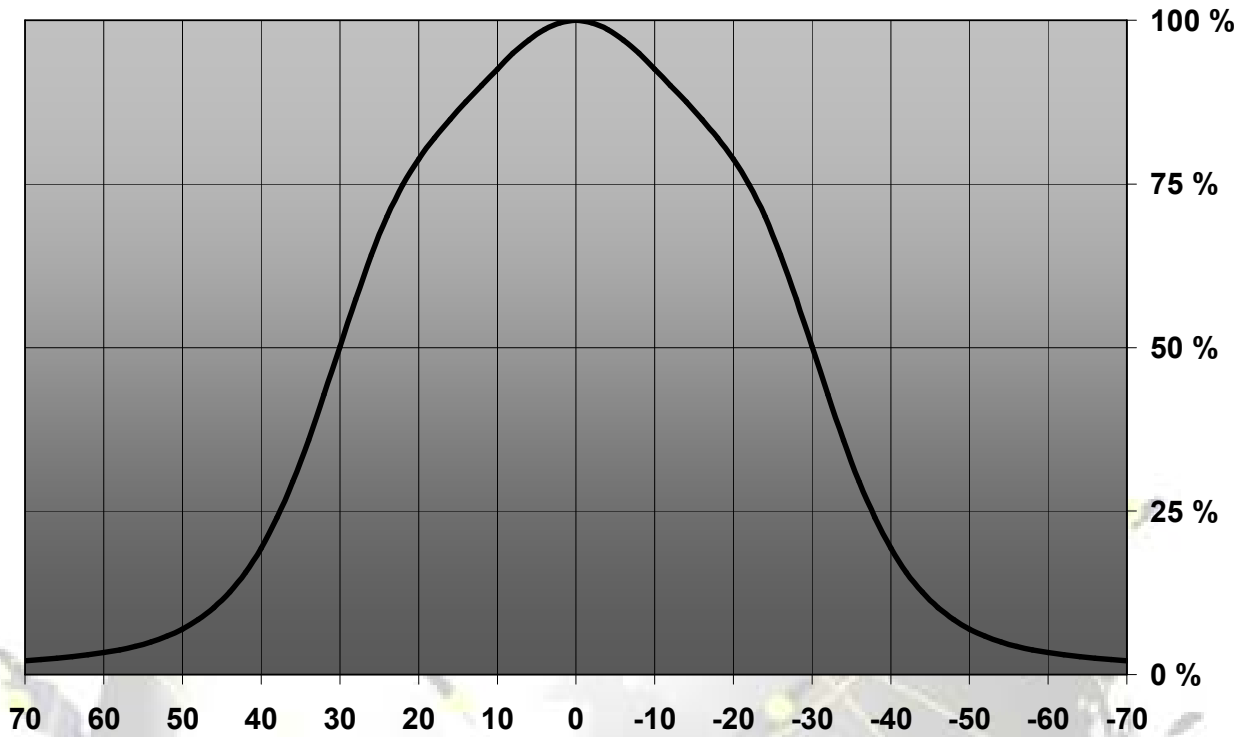

© Ledil Oy – PRELIMINARY - Subject to change without prior notice

DRAWINGS

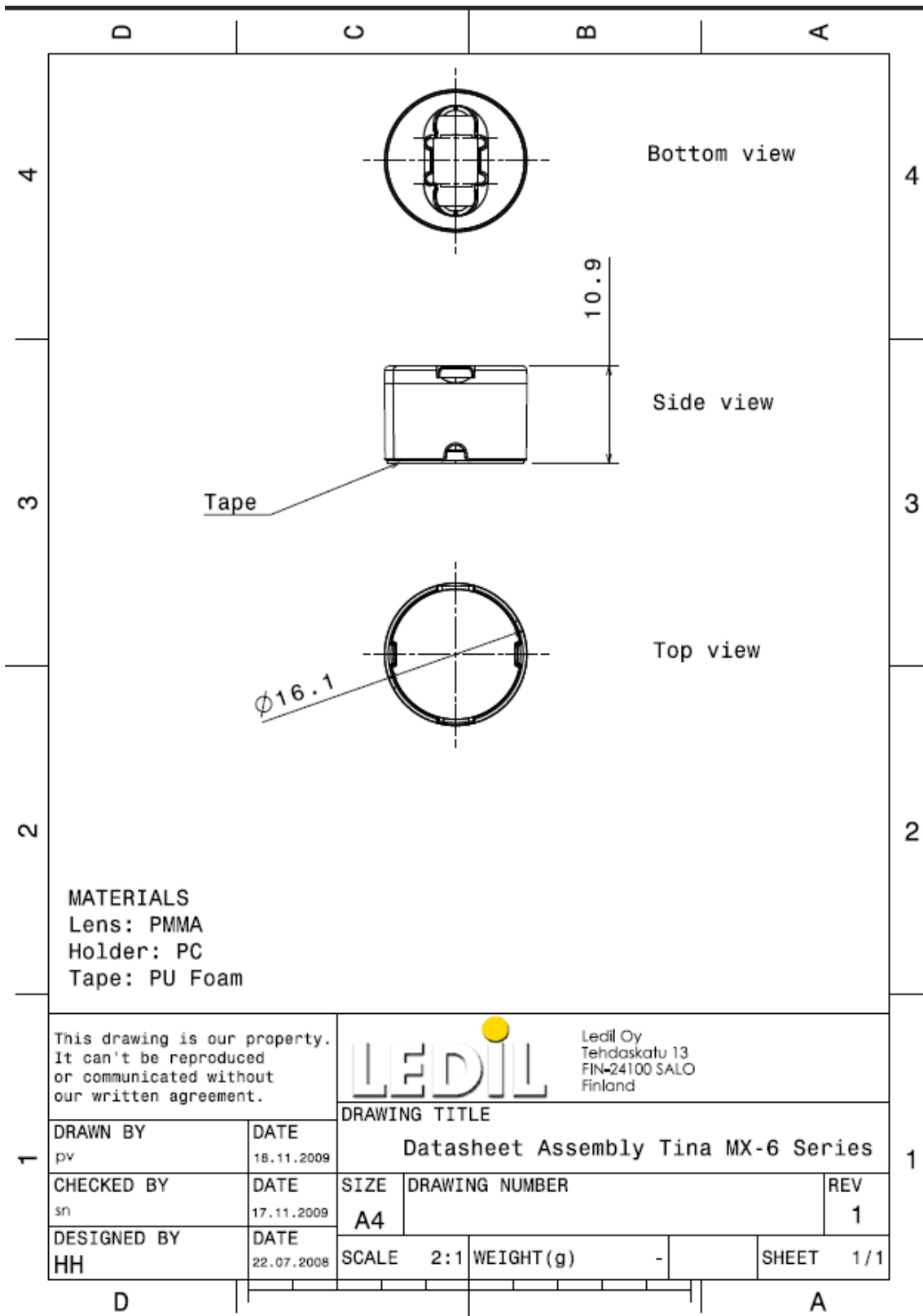

© Ledil Oy - PRELIMINARY - Subject to change without prior notice