



STS6NF20V

N-channel 20 V, 0.030 Ω typ., 6 A 2.7 V drive STripFET™ II
Power MOSFET in a SO-8 package

Datasheet — production data

Features

Order code	V _{DSS}	R _{DS(on)}	I _D
STS6NF20V	20 V	< 0.040 Ω (@4.5 V)	6 A
		< 0.045 Ω (@2.7 V)	

- Ultra low threshold gate drive (2.5 V)
- Standard outline for easy automated surface mount assembly

Applications

- Switching application

Description

This Power MOSFET has been developed using STMicroelectronics' unique STripFET process, which is specifically designed to minimize input capacitance and gate charge. This renders the device suitable for use as primary switch in advanced high-efficiency isolated DC-DC converters for telecom and computer applications, and applications with low gate charge driving requirements.

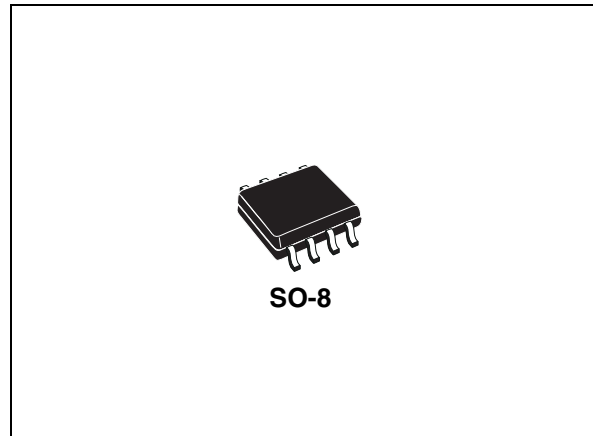

Figure 1. Schematic diagram

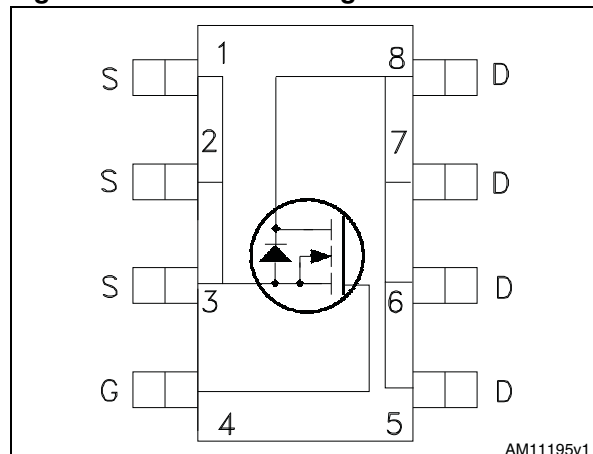

Table 1. Device summary

Order code	Marking	Package	Packaging
STS6NF20V	S6NF20V	SO-8	Tape and reel

Contents

1	Electrical ratings	3
2	Electrical characteristics	4
	2.1 Electrical characteristics (curves)	6
3	Test circuits	8
4	Package mechanical data	9
5	Revision history	11

1 Electrical ratings

Table 2. Absolute maximum ratings

Symbol	Parameter	Value	Unit
V_{DS}	Drain-source voltage	20	V
V_{GS}	Gate- source voltage	± 12	V
I_D	Drain current (continuous) at $T_C = 25\text{ }^\circ\text{C}$	6	A
I_D	Drain current (continuous) at $T_C = 100\text{ }^\circ\text{C}$	3.8	A
$I_{DM}^{(1)}$	Drain current (pulsed)	24	A
P_{TOT}	Total dissipation at $T_C = 25\text{ }^\circ\text{C}$	2.5	W
T_{stg}	Storage temperature	-55 to 150	$^\circ\text{C}$
T_j	Max. operating junction temperature	150	$^\circ\text{C}$

1. Pulse width limited by safe operating area

Table 3. Thermal data

Symbol	Parameter	Value	Unit
$R_{thj-amb}$	Thermal resistance junction-ambient max	50	$^\circ\text{C/W}$

2 Electrical characteristics

($T_C = 25\text{ °C}$ unless otherwise specified)

Table 4. On /off states

Symbol	Parameter	Test conditions	Min.	Typ.	Max.	Unit
$V_{(BR)DSS}$	Drain-source breakdown voltage	$I_D = 250\ \mu\text{A}$, $V_{GS} = 0$	20			V
I_{DSS}	Zero gate voltage drain current ($V_{GS} = 0$)	$V_{DS} = 20\ \text{V}$ $V_{DS} = 20\ \text{V}$, $T_C = 125\text{ °C}$			1 10	μA μA
I_{GSS}	Gate-body leakage current ($V_{DS} = 0$)	$V_{GS} = \pm 12\text{V}$			± 100	nA
$V_{GS(th)}$	Gate threshold voltage	$V_{DS} = V_{GS}$, $I_D = 250\ \mu\text{A}$	0.6			V
$R_{DS(on)}$	Static drain-source on- resistance	$V_{GS} = 4.5\ \text{V}$, $I_D = 3\ \text{A}$		0.030	0.040	Ω
		$V_{GS} = 2.7\ \text{V}$, $I_D = 3\ \text{A}$		0.037	0.045	Ω
		$V_{GS} = 1.95\ \text{V}$, $I_D = 0.9\ \text{A}$			0.09	Ω

Table 5. Dynamic

Symbol	Parameter	Test conditions	Min.	Typ.	Max.	Unit
g_{fs}	Forward transconductance		6.5	10	15	S
C_{iss}	Input capacitance	$V_{DS} = 15\ \text{V}$, $f = 1\ \text{MHz}$, $V_{GS} = 0$	320	460	640	pF
C_{oss}	Output capacitance					
C_{rss}	Reverse transfer capacitance					
Q_g	Total gate charge	$V_{DD} = 16\ \text{V}$, $I_D = 6\ \text{A}$,	5.5	8.5	11.5	nC
Q_{gs}	Gate-source charge	$V_{GS} = 4.5\ \text{V}$	1.2	1.8	2.5	nC
Q_{gd}	Gate-drain charge	(see Figure 13)	1.6	2.4	3.4	nC

Table 6. Switching times

Symbol	Parameter	Test conditions	Min.	Typ.	Max.	Unit
$t_{d(on)}$	Turn-on delay time	$V_{DD} = 10\text{ V}$, $I_D = 3\text{ A}$, $R_G = 4.7\ \Omega$, $V_{GS} = 4.5\text{ V}$ (see Figure 12)	-	7	20	ns
t_r	Rise time			33	45	ns
$t_{d(off)}$	Turn-off-delay time			27	40	ns
t_f	Fall time			10	20	ns

Table 7. Source drain diode

Symbol	Parameter	Test conditions	Min.	Typ.	Max.	Unit
I_{SD}	Source-drain current		-		6	A
$I_{SDM}^{(1)}$	Source-drain current (pulsed)				24	A
$V_{SD}^{(2)}$	Forward on voltage	$I_{SD} = 6\text{ A}$, $V_{GS} = 0$	-		1.5	V
t_{rr}	Reverse recovery time	$I_{SD} = 6\text{ A}$, $di/dt = 100\text{ A}/\mu\text{s}$ $V_{DD} = 10\text{ V}$, $T_j = 150\text{ }^\circ\text{C}$ (see Figure 17)	-	26		ns
Q_{rr}	Reverse recovery charge			13		nC
I_{RRM}	Reverse recovery current			1		A

1. Pulse width limited by safe operating area
2. Pulsed: Pulse duration = 300 μs , duty cycle 1.5%

2.1 Electrical characteristics (curves)

Figure 2. Safe operating area

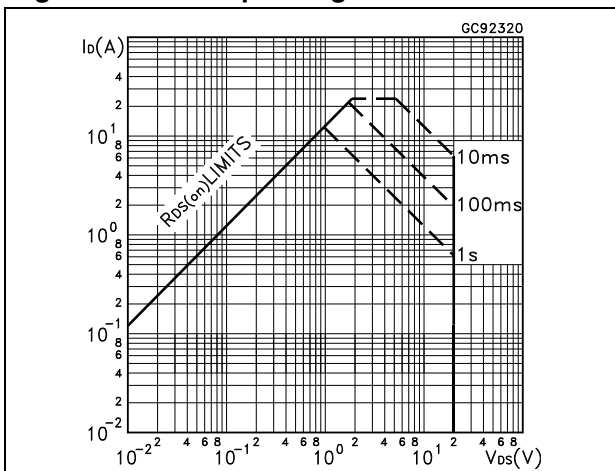

Figure 3. Thermal impedance

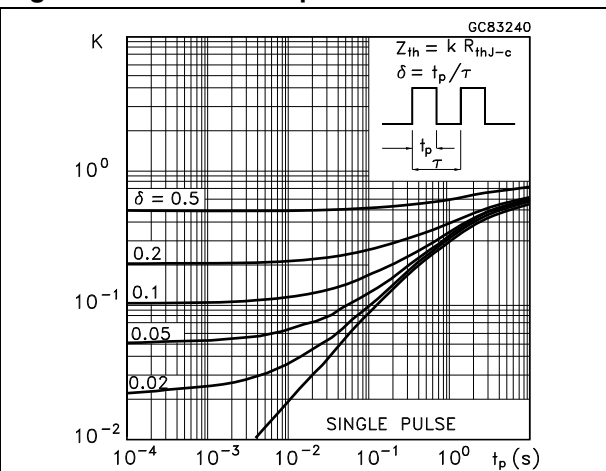

Figure 4. Output characteristics

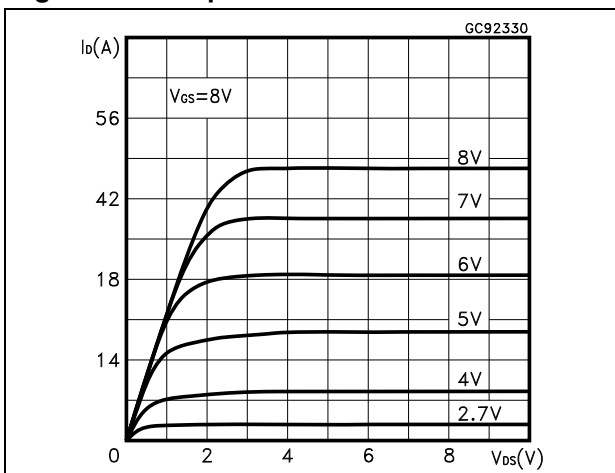

Figure 5. Transfer characteristics

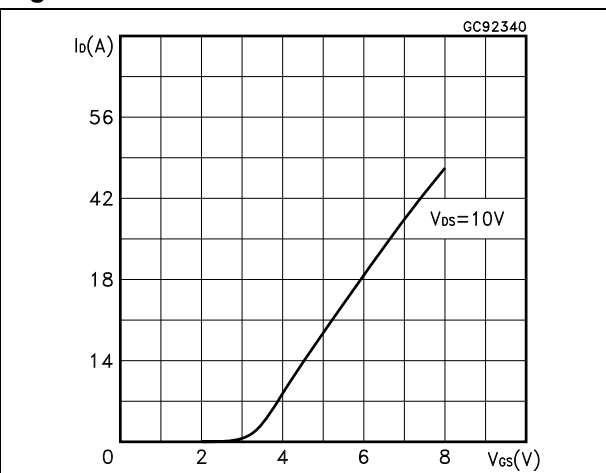

Figure 6. Source-drain diode forward characteristics

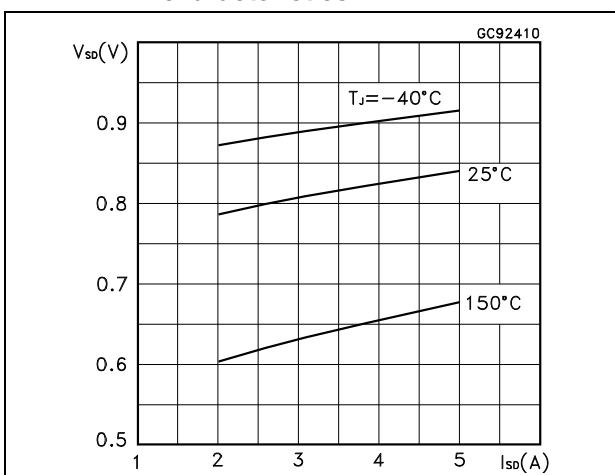

Figure 7. Static drain-source on-resistance

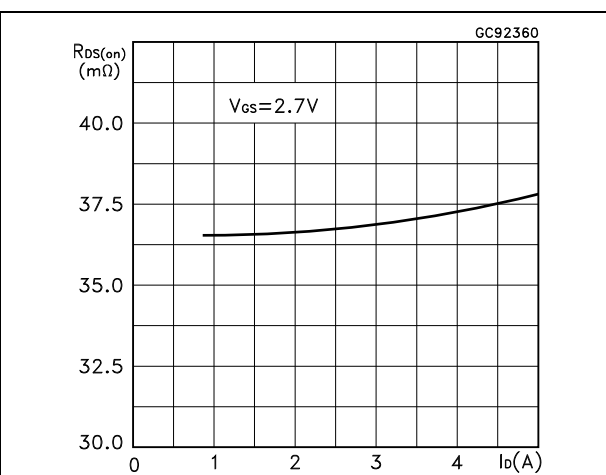

Figure 8. Gate charge vs gate-source voltage Figure 9. Capacitance variations

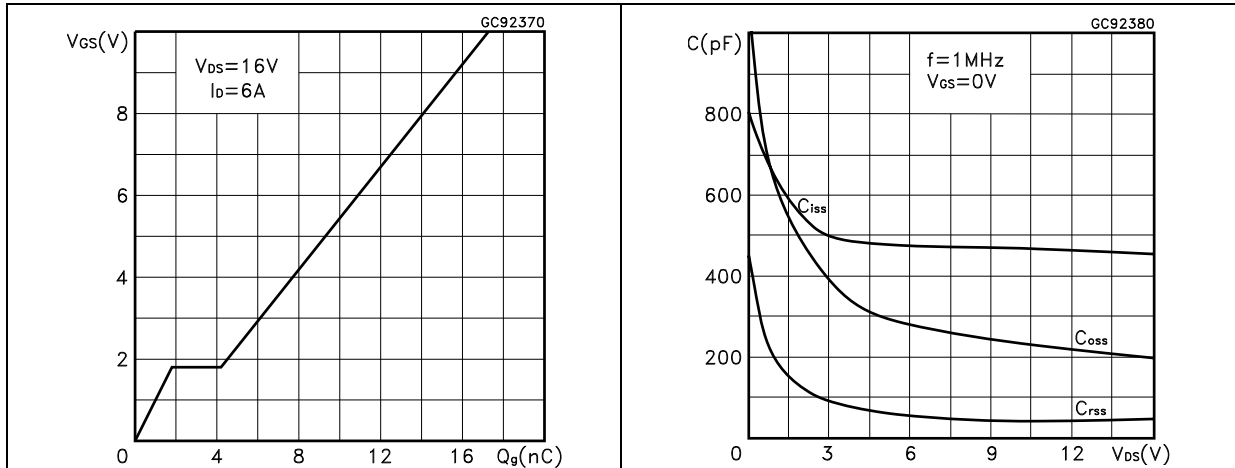
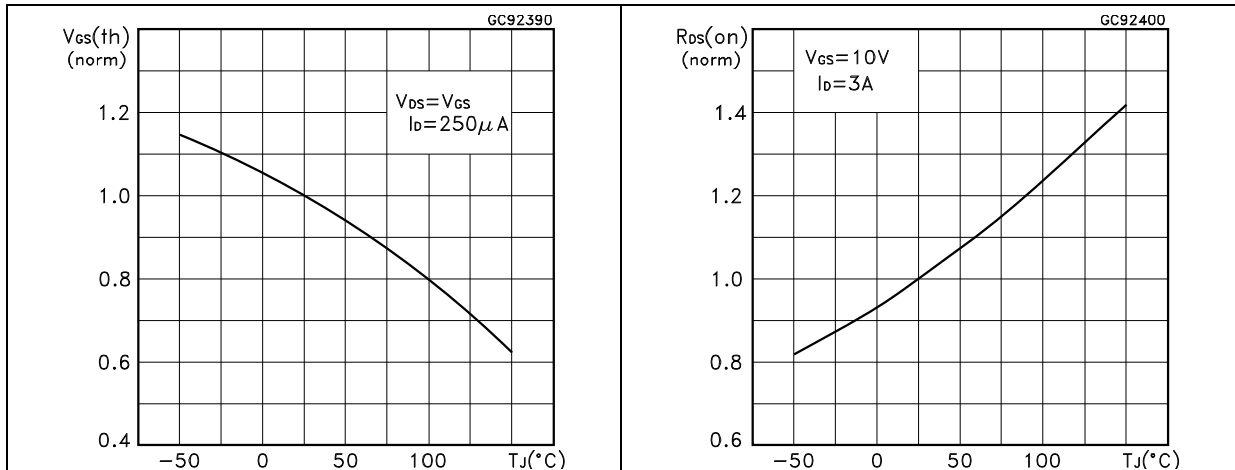

Figure 10. Normalized gate threshold voltage vs temperature Figure 11. Normalized on-resistance vs temperature



3 Test circuits

Figure 12. Switching times test circuit for resistive load



AM01468v1

Figure 13. Gate charge test circuit



AM01469v1

Figure 14. Test circuit for inductive load switching and diode recovery times



AM01470v1

Figure 15. Unclamped inductive load test circuit



AM01471v1

Figure 16. Unclamped inductive waveform



AM01472v1

Figure 17. Switching time waveform

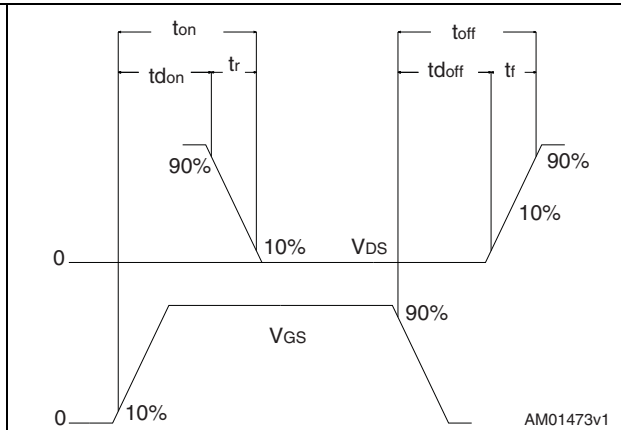

AM01473v1

4 Package mechanical data

In order to meet environmental requirements, ST offers these devices in different grades of ECOPACK® packages, depending on their level of environmental compliance. ECOPACK® specifications, grade definitions and product status are available at: www.st.com. ECOPACK is an ST trademark.

Table 8. SO-8 mechanical data

Dim.	mm		
	Min.	Typ.	Max.
A			1.75
A1	0.10		0.25
A2	1.25		
b	0.28		0.48
c	0.17		0.23
D	4.80	4.90	5.00
E	5.80	6.00	6.20
E1	3.80	3.90	4.00
e		1.27	
h	0.25		0.50
L	0.40		1.27
L1		1.04	
k	0°		8°
ccc			0.10

Figure 18. SO-8 drawing

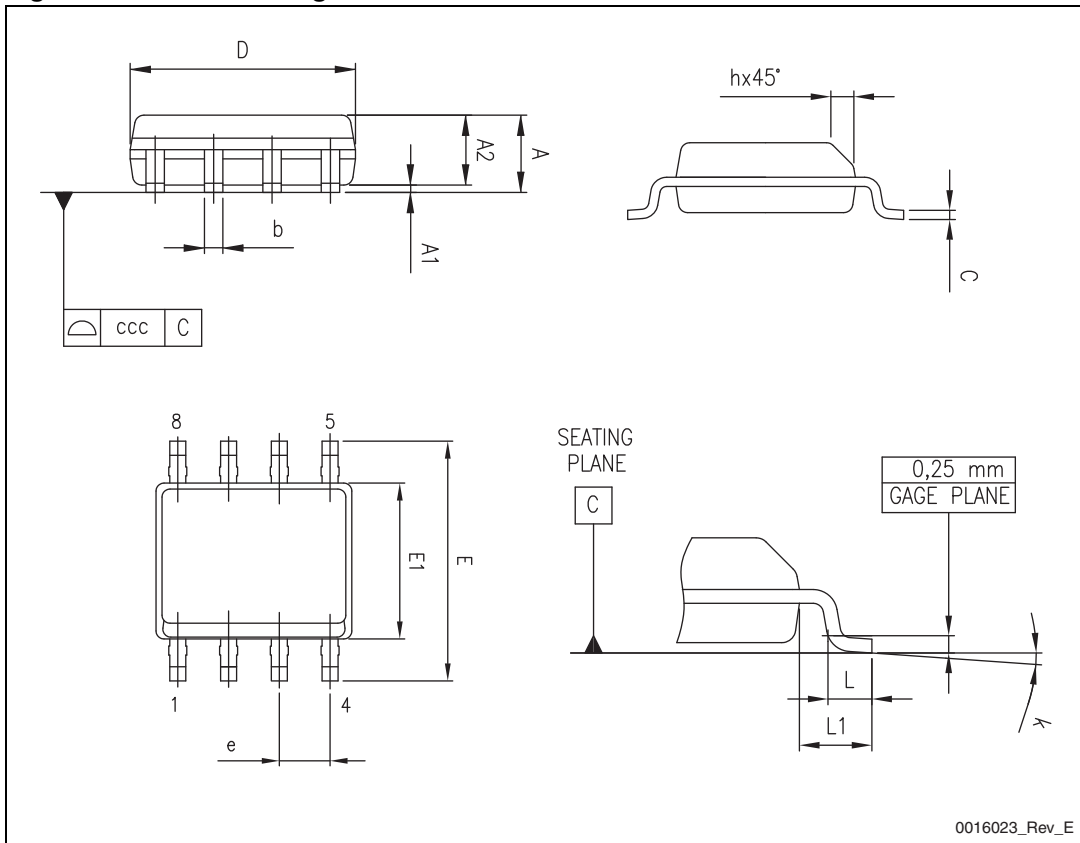

5 Revision history

Table 9. Document revision history

Date	Revision	Changes
07-Feb-2008	1	First release
18-Nov-2009	2	Added new $R_{DS(on)}$ value on Table 4: On /off states
29-Nov-2012	3	Max values have been added in Table 5: Dynamic and Table 6: Switching times . Section 4: Package mechanical data has been updated. Minor text changes.

Please Read Carefully:

Information in this document is provided solely in connection with ST products. STMicroelectronics NV and its subsidiaries ("ST") reserve the right to make changes, corrections, modifications or improvements, to this document, and the products and services described herein at any time, without notice.

All ST products are sold pursuant to ST's terms and conditions of sale.

Purchasers are solely responsible for the choice, selection and use of the ST products and services described herein, and ST assumes no liability whatsoever relating to the choice, selection or use of the ST products and services described herein.

No license, express or implied, by estoppel or otherwise, to any intellectual property rights is granted under this document. If any part of this document refers to any third party products or services it shall not be deemed a license grant by ST for the use of such third party products or services, or any intellectual property contained therein or considered as a warranty covering the use in any manner whatsoever of such third party products or services or any intellectual property contained therein.

UNLESS OTHERWISE SET FORTH IN ST'S TERMS AND CONDITIONS OF SALE ST DISCLAIMS ANY EXPRESS OR IMPLIED WARRANTY WITH RESPECT TO THE USE AND/OR SALE OF ST PRODUCTS INCLUDING WITHOUT LIMITATION IMPLIED WARRANTIES OF MERCHANTABILITY, FITNESS FOR A PARTICULAR PURPOSE (AND THEIR EQUIVALENTS UNDER THE LAWS OF ANY JURISDICTION), OR INFRINGEMENT OF ANY PATENT, COPYRIGHT OR OTHER INTELLECTUAL PROPERTY RIGHT.

UNLESS EXPRESSLY APPROVED IN WRITING BY TWO AUTHORIZED ST REPRESENTATIVES, ST PRODUCTS ARE NOT RECOMMENDED, AUTHORIZED OR WARRANTED FOR USE IN MILITARY, AIR CRAFT, SPACE, LIFE SAVING, OR LIFE SUSTAINING APPLICATIONS, NOR IN PRODUCTS OR SYSTEMS WHERE FAILURE OR MALFUNCTION MAY RESULT IN PERSONAL INJURY, DEATH, OR SEVERE PROPERTY OR ENVIRONMENTAL DAMAGE. ST PRODUCTS WHICH ARE NOT SPECIFIED AS "AUTOMOTIVE GRADE" MAY ONLY BE USED IN AUTOMOTIVE APPLICATIONS AT USER'S OWN RISK.

Resale of ST products with provisions different from the statements and/or technical features set forth in this document shall immediately void any warranty granted by ST for the ST product or service described herein and shall not create or extend in any manner whatsoever, any liability of ST.

ST and the ST logo are trademarks or registered trademarks of ST in various countries.

Information in this document supersedes and replaces all information previously supplied.

The ST logo is a registered trademark of STMicroelectronics. All other names are the property of their respective owners.

© 2012 STMicroelectronics - All rights reserved

STMicroelectronics group of companies

Australia - Belgium - Brazil - Canada - China - Czech Republic - Finland - France - Germany - Hong Kong - India - Israel - Italy - Japan - Malaysia - Malta - Morocco - Philippines - Singapore - Spain - Sweden - Switzerland - United Kingdom - United States of America

www.st.com