

Features

- Very high frequency operation
- Low C_{RES} / C_{IES} ratio (no cross-conduction susceptibility)
- Very soft ultra fast recovery antiparallel diode

Applications

- Very high frequency inverters, UPS
- HF, SMPS and PFC in both hard switch and resonant topologies
- Motor drivers
- Welding

Description

This IGBT utilizes the advanced Power MESH™ process resulting in an excellent trade-off between switching performance and low on-state behavior.

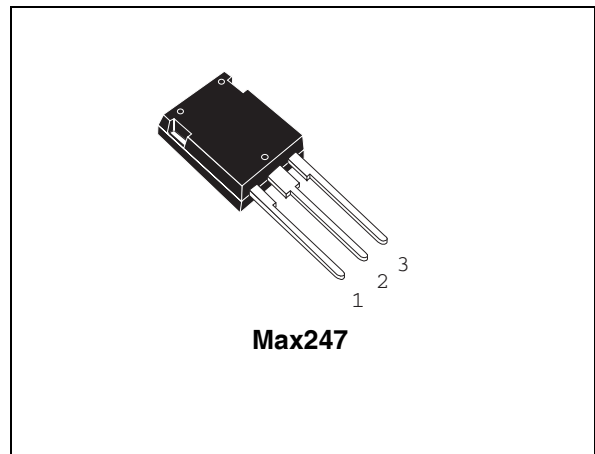

Figure 1. Internal schematic diagram

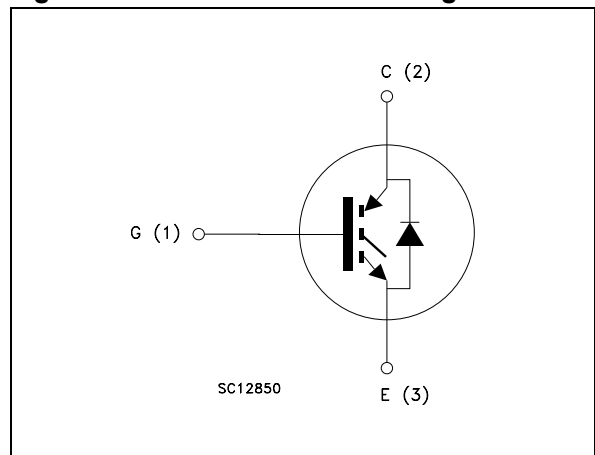

Table 1. Device summary

Order code	Marking	Package	Packaging
STGY50NC60WD	GY50NC60WD	Max247	Tube

Contents

1	Electrical ratings	3
2	Electrical characteristics	4
	2.1 Electrical characteristics (curves)	7
3	Test circuit	10
4	Package mechanical data	11
5	Revision history	13

1 Electrical ratings

Table 1. Absolute maximum ratings

Symbol	Parameter	Value	Unit
V_{CES}	Collector-emitter voltage ($V_{GE} = 0$)	600	V
$I_C^{(1)}$	Collector current (continuous) at $T_C = 25\text{ °C}$	110	A
$I_C^{(1)}$	Collector current (continuous) at $T_C = 100\text{ °C}$	50	A
$I_{CL}^{(2)}$	Turn-off latching current	180	A
$I_{CP}^{(3)}$	Pulsed collector current	180	A
I_F	Diode RMS forward current at $T_C = 25\text{ °C}$	30	A
I_{FSM}	Surge not repetitive forward current ($t_p=10\text{ ms}$ sinusoidal)	120	A
V_{GE}	Gate-emitter voltage	± 20	V
P_{TOT}	Total dissipation at $T_C = 25\text{ °C}$	278	W
T_j	Operating junction temperature	-55 to 150	$^{\circ}\text{C}$

1. Calculated according to the iterative formula:

$$I_C(T_C) = \frac{T_{j(max)} - T_C}{R_{thj-c} \times V_{CE(sat)(max)}(T_{j(max)}, I_C(T_C))}$$

2. $V_{clamp} = 80\%$ of V_{CES} , $T_j = 150\text{ °C}$, $R_G = 10\ \Omega$, $V_{GE} = 15\text{ V}$

3. Pulse width limited by max. temperature allowed

Table 2. Thermal resistance

Symbol	Parameter	Value	Unit
$R_{thj-case}$	Thermal resistance junction-case IGBT max.	0.45	$^{\circ}\text{C/W}$
$R_{thj-case}$	Thermal resistance junction-case diode max.	1.5	$^{\circ}\text{C/W}$
$R_{thj-amb}$	Thermal resistance junction-ambient max.	50	$^{\circ}\text{C/W}$

2 Electrical characteristics

($T_{CASE} = 25\text{ °C}$ unless otherwise specified)

Table 3. Static

Symbol	Parameter	Test conditions	Min.	Typ.	Max.	Unit
$V_{(BR)CES}$	Collector-emitter breakdown voltage ($V_{GE} = 0$)	$I_C = 1\text{ mA}$	600			V
$V_{CE(sat)}$	Collector-emitter saturation voltage	$V_{GE} = 15\text{ V}, I_C = 40\text{ A}$ $V_{GE} = 15\text{ V}, I_C = 40\text{ A}, T_C = 125\text{ °C}$		2.1 1.9	2.6	V V
$V_{GE(th)}$	Gate threshold voltage	$V_{CE} = V_{GE}, I_C = 250\text{ }\mu\text{A}$	3.75		5.75	V
I_{CES}	Collector cut-off current ($V_{GE} = 0$)	$V_{CE} = 600\text{ V}$ $V_{CE} = 600\text{ V}, T_C = 125\text{ °C}$			500 5	μA mA
I_{GES}	Gate-emitter leakage current ($V_{CE} = 0$)	$V_{GE} = \pm 20\text{ V}$			± 100	nA
g_{fs}	Forward transconductance	$V_{CE} = 15\text{ V}, I_C = 40\text{ A}$		25		S

Table 4. Dynamic

Symbol	Parameter	Test conditions	Min.	Typ.	Max.	Unit
C_{ies}	Input capacitance	$V_{CE} = 25\text{ V}, f = 1\text{ MHz},$ $V_{GE} = 0$		4700		pF
C_{oes}	Output capacitance			410		pF
C_{res}	Reverse transfer capacitance			90		pF
Q_g	Total gate charge	$V_{CE} = 390\text{ V}, I_C = 40\text{ A},$		195		nC
Q_{ge}	Gate-emitter charge	$V_{GE} = 15\text{ V},$		32		nC
Q_{gc}	Gate-collector charge	Figure 16		82		nC

Table 5. Switching on/off (inductive load)

Symbol	Parameter	Test conditions	Min.	Typ.	Max.	Unit
$t_{d(on)}$ t_r $(di/dt)_{on}$	Turn-on delay time Current rise time Turn-on current slope	$V_{CC} = 390\text{ V}$, $I_C = 40\text{ A}$ $R_G = 10\ \Omega$, $V_{GE} = 15\text{ V}$, <i>Figure 17, Figure 15</i>		52 17 2400		ns ns A/ μ s
$t_{d(on)}$ t_r $(di/dt)_{on}$	Turn-on delay time Current rise time Turn-on current slope	$V_{CC} = 390\text{ V}$, $I_C = 40\text{ A}$ $R_G = 10\ \Omega$, $V_{GE} = 15\text{ V}$, $T_C = 125\text{ }^\circ\text{C}$ <i>Figure 17, Figure 15</i>		50 19 2020		ns ns A/ μ s
$t_{r(Voff)}$ $t_{d(Voff)}$ t_f	Off voltage rise time Turn-off delay time Current fall time	$V_{CC} = 390\text{ V}$, $I_C = 40\text{ A}$ $R_G = 10\ \Omega$, $V_{GE} = 15\text{ V}$, <i>Figure 17, Figure 15</i>		31 240 35		ns ns ns
$t_{r(Voff)}$ $t_{d(Voff)}$ t_f	Off voltage rise time Turn-off delay time Current fall time	$V_{CC} = 390\text{ V}$, $I_C = 40\text{ A}$ $R_G = 10\ \Omega$, $V_{GE} = 15\text{ V}$, $T_C = 125\text{ }^\circ\text{C}$ <i>Figure 17, Figure 15</i>		59 280 63		ns ns ns

Table 6. Switching energy (inductive load)

Symbol	Parameter	Test conditions	Min.	Typ.	Max.	Unit
$E_{on}^{(1)}$ $E_{off}^{(2)}$ E_{ts}	Turn-on switching losses Turn-off switching losses Total switching losses	$V_{CC} = 390\text{ V}$, $I_C = 40\text{ A}$ $R_G = 10\ \Omega$, $V_{GE} = 15\text{ V}$, <i>Figure 15</i>		365 560 925	470 790 1260	μ J μ J μ J
$E_{on}^{(1)}$ $E_{off}^{(2)}$ E_{ts}	Turn-on switching losses Turn-off switching losses Total switching losses	$V_{CC} = 390\text{ V}$, $I_C = 40\text{ A}$ $R_G = 10\ \Omega$, $V_{GE} = 15\text{ V}$, $T_C = 125\text{ }^\circ\text{C}$ <i>Figure 15</i>		635 910 1545		μ J μ J μ J

1. E_{on} is the turn-on losses when a typical diode is used in the test circuit in *Figure 18*. If the IGBT is offered in a package with a co-pack diode, the co-pack diode is used as external diode. IGBTs & Diode are at the same temperature (25°C and 125°C)
2. Turn-off losses include also the tail of the collector current

Table 7. Collector-emitter diode

Symbol	Parameter	Test conditions	Min.	Typ.	Max.	Unit
V_F	Forward on-voltage	$I_F = 40\text{ A}$		3.2		V
		$I_F = 40\text{ A}, T_C = 125\text{ °C}$		2.2		V
t_{rr}	Reverse recovery time	$I_F = 40\text{ A}, V_R = 50\text{ V},$ $di/dt = 100\text{ A}/\mu\text{s}$		55		ns
Q_{rr}	Reverse recovery charge	$di/dt = 100\text{ A}/\mu\text{s}$		100		nC
I_{rrm}	Reverse recovery current	<i>Figure 18</i>		3.6		A
t_{rr}	Reverse recovery time	$I_F = 40\text{ A}, V_R = 50\text{ V},$ $T_C = 125\text{ °C},$ $di/dt = 100\text{ A}/\mu\text{s}$ (<i>Figure 18</i>)		164		ns
Q_{rr}	Reverse recovery charge	$T_C = 125\text{ °C},$ $di/dt = 100\text{ A}/\mu\text{s}$ (<i>Figure 18</i>)		525		nC
I_{rrm}	Reverse recovery current	$di/dt = 100\text{ A}/\mu\text{s}$ (<i>Figure 18</i>)		6.4		A

2.1 Electrical characteristics (curves)

Figure 1. Output characteristics

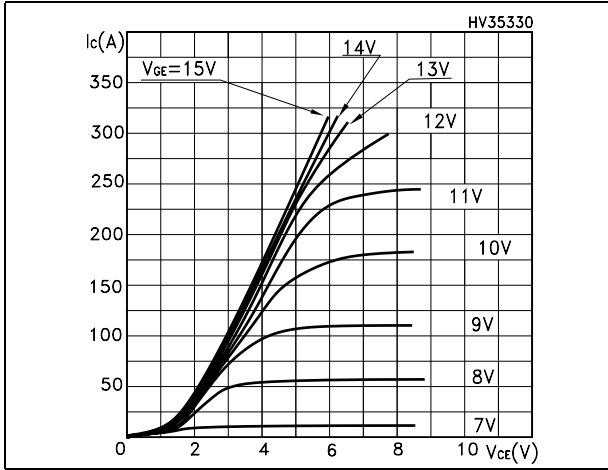

Figure 2. Transfer characteristics

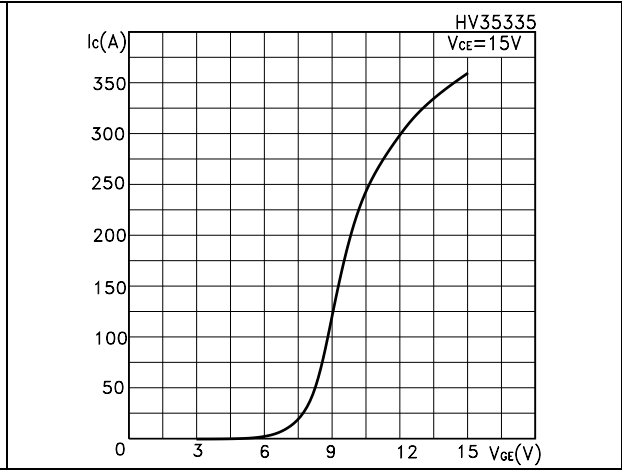

Figure 3. Transconductance

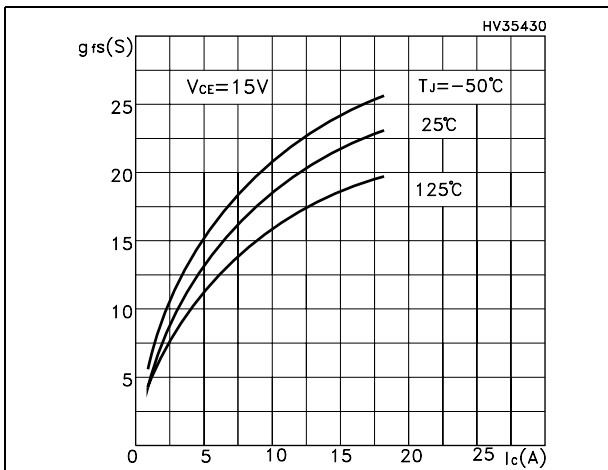

Figure 4. Collector-emitter on voltage vs temperature

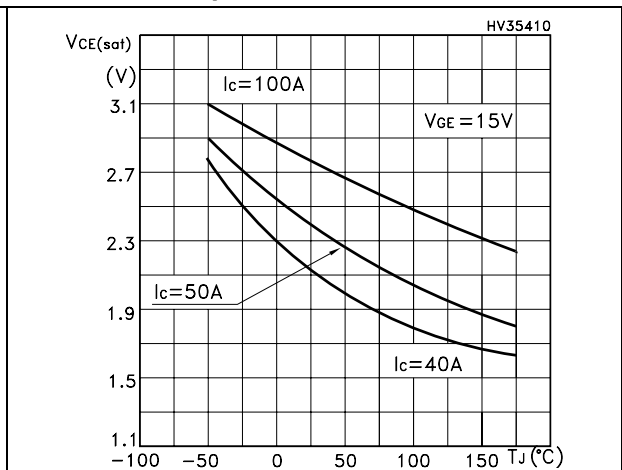

Figure 5. Gate charge vs gate-source voltage Figure 6. Capacitance variations

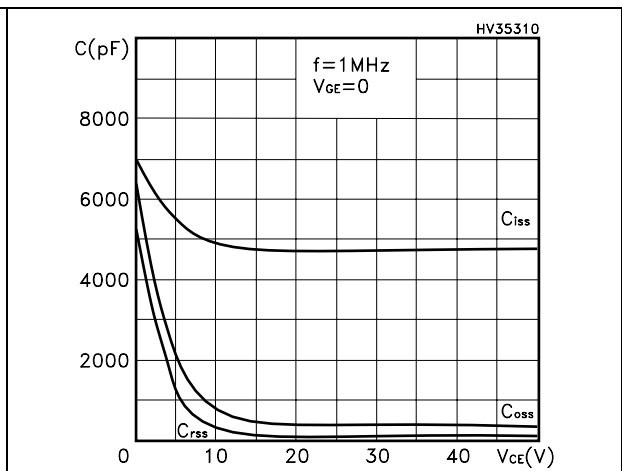
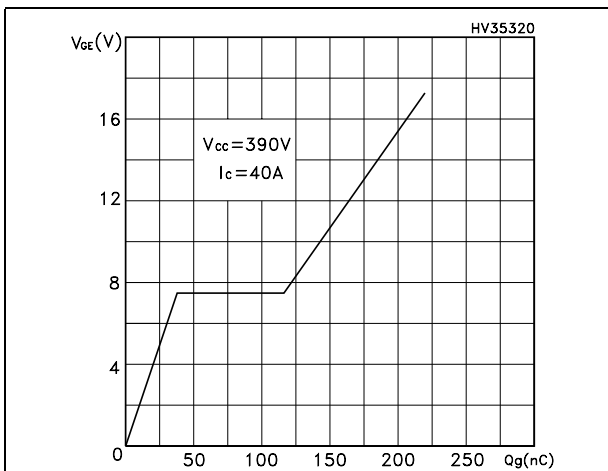

Figure 7. Normalized gate threshold voltage vs temperature

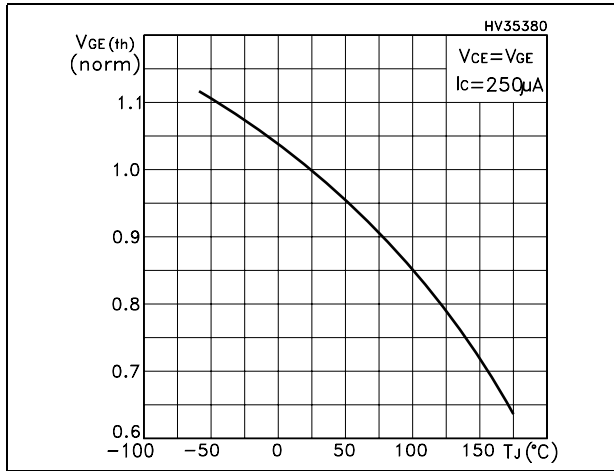

Figure 8. Collector-emitter on voltage vs collector current

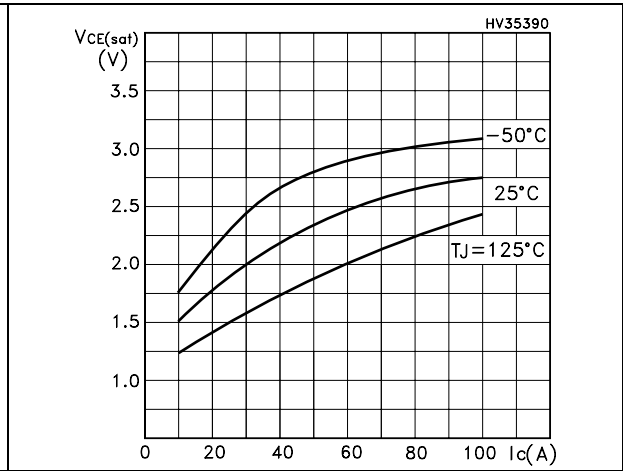

Figure 9. Normalized breakdown voltage vs temperature

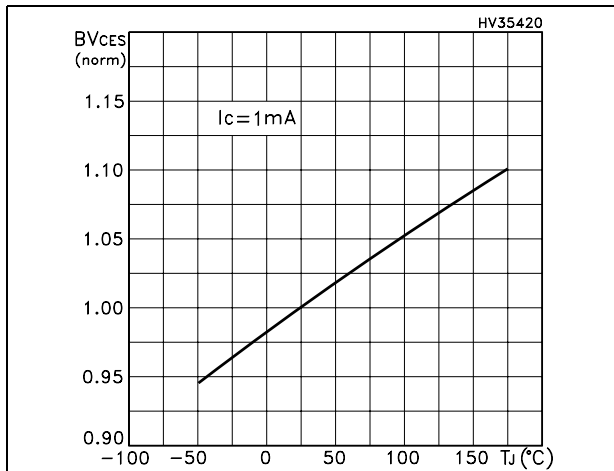

Figure 10. Switching losses vs temperature

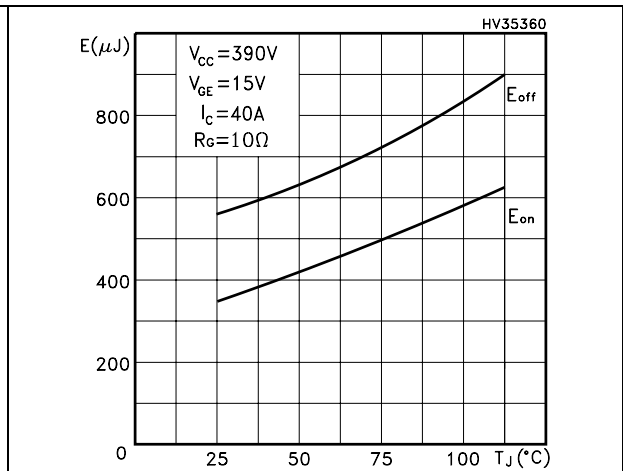

Figure 11. Switching losses vs gate resistance

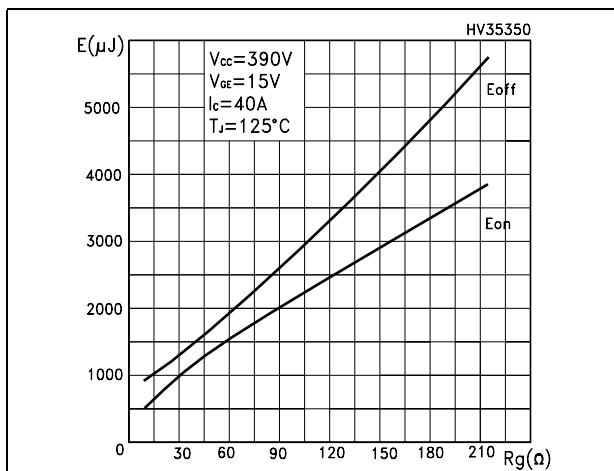

Figure 12. Switching losses vs collector current

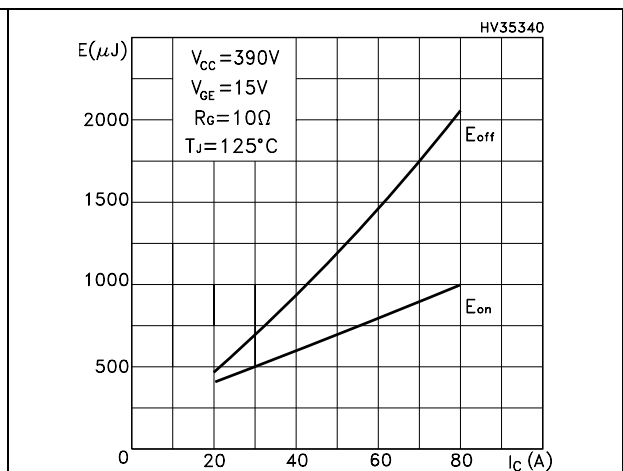

Figure 13. Turn-off SOA

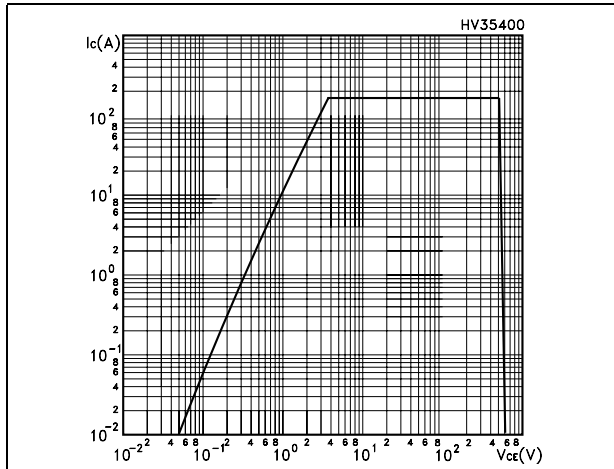
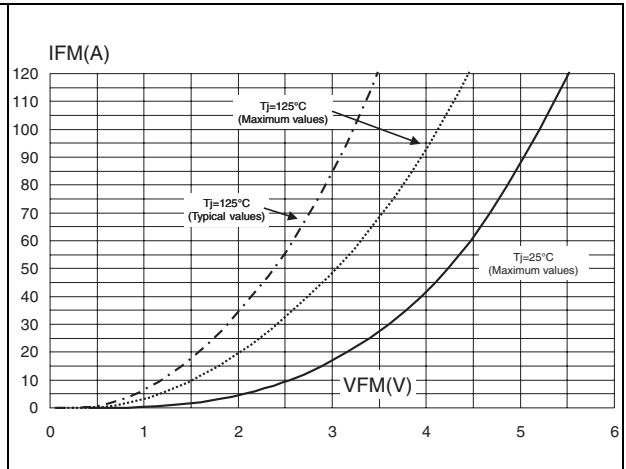

Figure 14. Forward voltage drop vs. forward current



3 Test circuit

Figure 15. Test circuit for inductive load switching



Figure 16. Gate charge test circuit

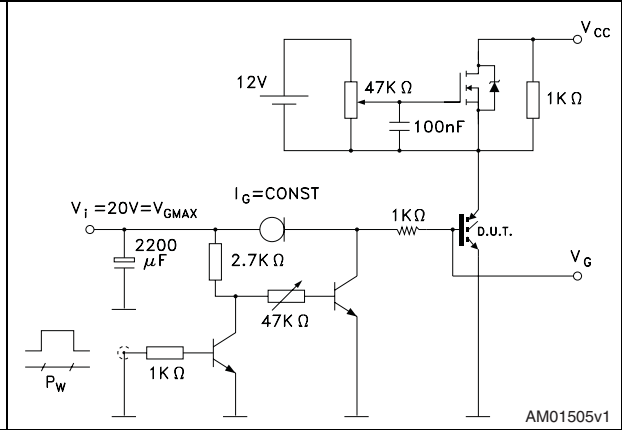

Figure 17. Switching waveform

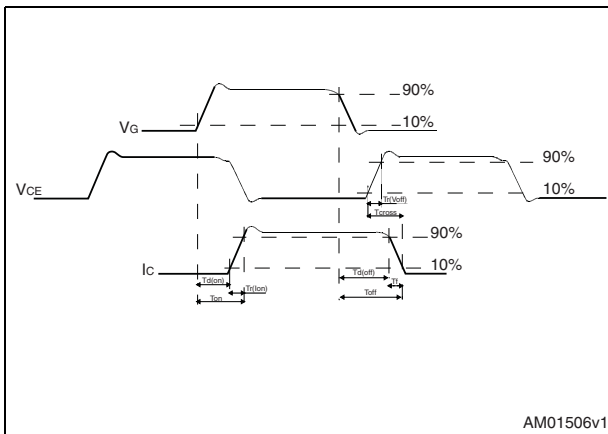
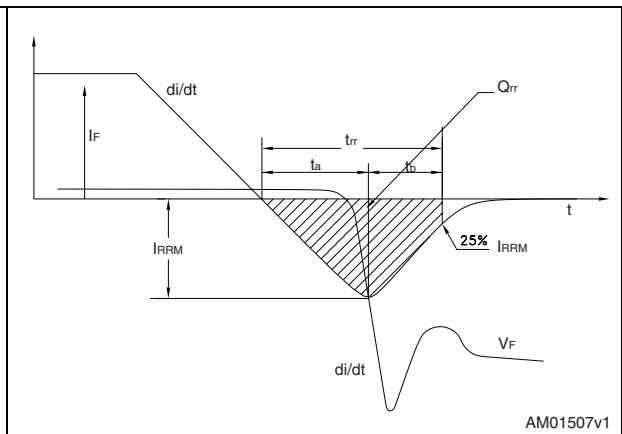

Figure 18. Diode recovery time waveform



4 Package mechanical data

In order to meet environmental requirements, ST offers these devices in different grades of ECOPACK® packages, depending on their level of environmental compliance. ECOPACK® specifications, grade definitions and product status are available at: www.st.com. ECOPACK® is an ST trademark.

Table 8. Max247 mechanical data

Dim.	mm		
	Min.	Typ.	Max.
A	4.70		5.30
A1	2.20		2.60
b	1.00		1.40
b1	2.00		2.40
b2	3.00		3.40
c	0.40		0.80
D	19.70		20.30
e	5.35		5.55
E	15.30		15.90
L	14.20		15.20
L1	3.70		4.30

Figure 19. Max247 drawing

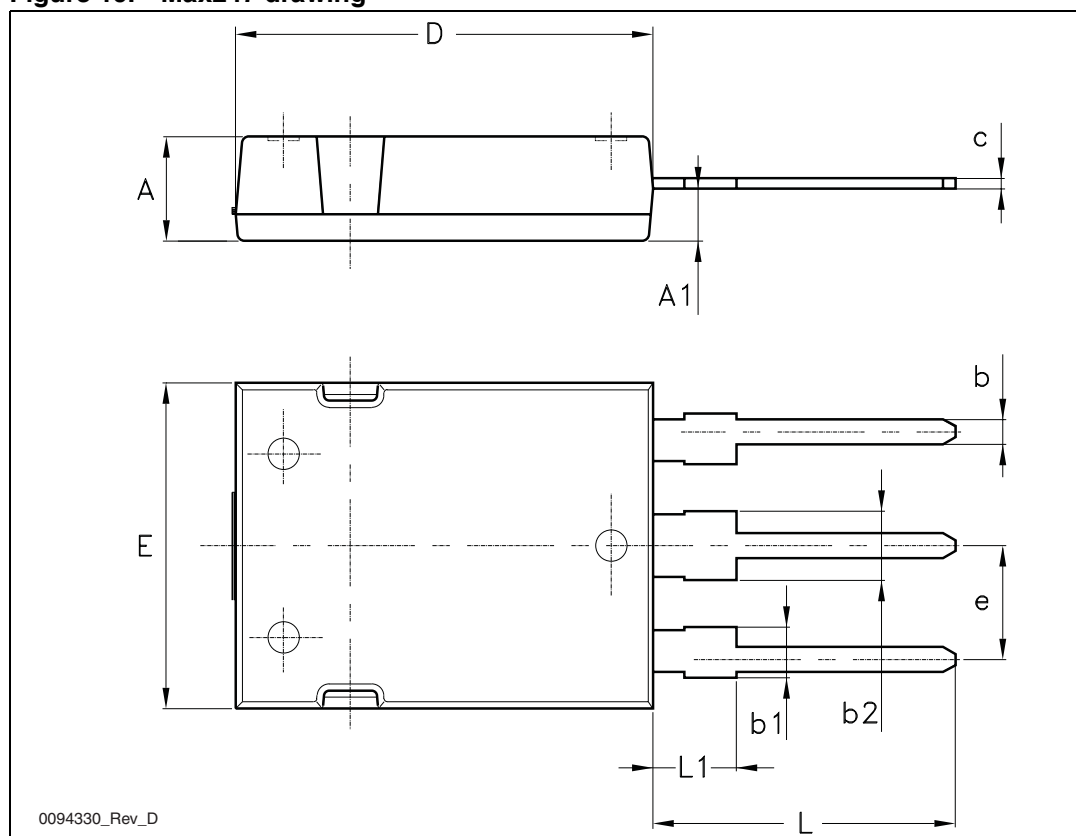

5 Revision history

Table 9. Document revision history

Date	Revision	Changes
09-Oct-2006	1	Initial release.
07-May-2007	2	Complete version
02-Jul-2007	3	Modified value on Table 2: Thermal resistance
04-Nov-2008	4	Table 8: Max247 mechanical data and Figure 19: Max247 drawing have been updated.
09-Jan-2009	5	Figure 13: Turn-off SOA has been updated.

Please Read Carefully:

Information in this document is provided solely in connection with ST products. STMicroelectronics NV and its subsidiaries ("ST") reserve the right to make changes, corrections, modifications or improvements, to this document, and the products and services described herein at any time, without notice.

All ST products are sold pursuant to ST's terms and conditions of sale.

Purchasers are solely responsible for the choice, selection and use of the ST products and services described herein, and ST assumes no liability whatsoever relating to the choice, selection or use of the ST products and services described herein.

No license, express or implied, by estoppel or otherwise, to any intellectual property rights is granted under this document. If any part of this document refers to any third party products or services it shall not be deemed a license grant by ST for the use of such third party products or services, or any intellectual property contained therein or considered as a warranty covering the use in any manner whatsoever of such third party products or services or any intellectual property contained therein.

UNLESS OTHERWISE SET FORTH IN ST'S TERMS AND CONDITIONS OF SALE ST DISCLAIMS ANY EXPRESS OR IMPLIED WARRANTY WITH RESPECT TO THE USE AND/OR SALE OF ST PRODUCTS INCLUDING WITHOUT LIMITATION IMPLIED WARRANTIES OF MERCHANTABILITY, FITNESS FOR A PARTICULAR PURPOSE (AND THEIR EQUIVALENTS UNDER THE LAWS OF ANY JURISDICTION), OR INFRINGEMENT OF ANY PATENT, COPYRIGHT OR OTHER INTELLECTUAL PROPERTY RIGHT.

UNLESS EXPRESSLY APPROVED IN WRITING BY AN AUTHORIZED ST REPRESENTATIVE, ST PRODUCTS ARE NOT RECOMMENDED, AUTHORIZED OR WARRANTED FOR USE IN MILITARY, AIR CRAFT, SPACE, LIFE SAVING, OR LIFE SUSTAINING APPLICATIONS, NOR IN PRODUCTS OR SYSTEMS WHERE FAILURE OR MALFUNCTION MAY RESULT IN PERSONAL INJURY, DEATH, OR SEVERE PROPERTY OR ENVIRONMENTAL DAMAGE. ST PRODUCTS WHICH ARE NOT SPECIFIED AS "AUTOMOTIVE GRADE" MAY ONLY BE USED IN AUTOMOTIVE APPLICATIONS AT USER'S OWN RISK.

Resale of ST products with provisions different from the statements and/or technical features set forth in this document shall immediately void any warranty granted by ST for the ST product or service described herein and shall not create or extend in any manner whatsoever, any liability of ST.

ST and the ST logo are trademarks or registered trademarks of ST in various countries.

Information in this document supersedes and replaces all information previously supplied.

The ST logo is a registered trademark of STMicroelectronics. All other names are the property of their respective owners.

© 2009 STMicroelectronics - All rights reserved

STMicroelectronics group of companies

Australia - Belgium - Brazil - Canada - China - Czech Republic - Finland - France - Germany - Hong Kong - India - Israel - Italy - Japan - Malaysia - Malta - Morocco - Singapore - Spain - Sweden - Switzerland - United Kingdom - United States of America

www.st.com