

FEATURES

- 16-Bit Monotonic Over Temperature
- Deglitched Rail-to-Rail Voltage Output: 8nV•s
- I_{CC} : 650 μ A Typ
- Maximum DNL Error: ± 1 LSB
- Settling Time: 20 μ s to ± 1 LSB
- Built-In Reference: 2.048V (LTC1657)
1.25V (LTC1657L)
- Internal Power-On Reset to Zero Volts
- Asynchronous CLR Pin
- Output Buffer Configurable for Gain of 1 or 2
- Parallel 16-Bit or 2-Byte Double Buffered Interface
- Narrow 28-Lead SSOP Package
- Multiplying Capability

APPLICATIONS

- Instrumentation
- Digital Calibration
- Industrial Process Control
- Automatic Test Equipment
- Communication Test Equipment

DESCRIPTION

The LTC[®]1657/LTC1657L are complete single supply, rail-to-rail voltage output, 16-bit digital-to-analog converters (DAC) in a 28-pin SSOP or PDIP package. They include a rail-to-rail output buffer amplifier, an internal reference and a double buffered parallel digital interface.

The LTC1657/LTC1657L have separate reference input pins that can be driven by an external reference. The full-scale output can be 1 or 2 times the reference voltage depending on how the X1/X2 pin is connected. The LTC1657 operates from a 4.5V to 5.5V supply and has an onboard 2.048V reference. The LTC1657L operates from a 2.7V to 5.5V supply and has an onboard 1.25V reference.

The LTC1657/LTC1657L are similar to Linear Technology Corporation's LTC1450/LTC1450L 12-bit V_{OUT} DAC family, allowing an upgrade path. They are the only buffered 16-bit parallel DACs in a 28-lead SSOP package and include an onboard reference for stand alone performance.

LT, LTC and LT are registered trademarks of Linear Technology Corporation.

BLOCK DIAGRAM

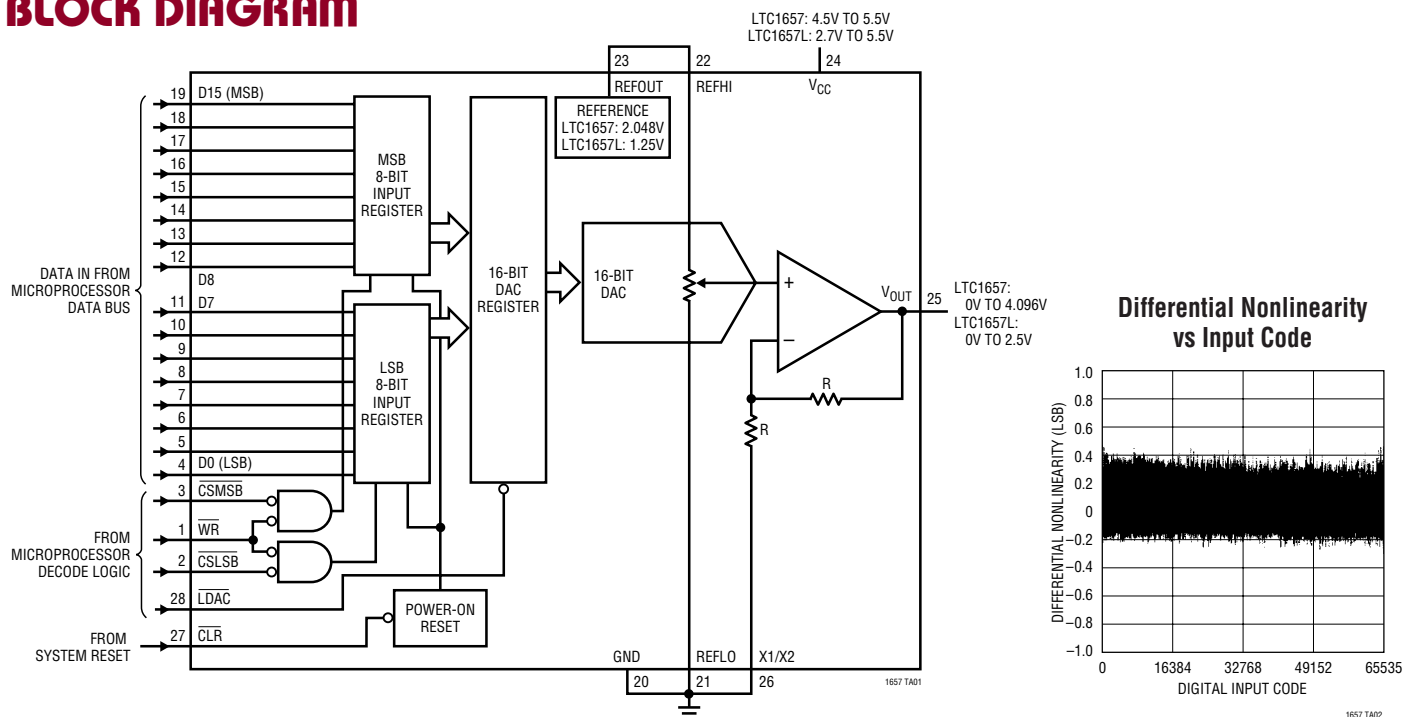

LTC1657/LTC1657L

ABSOLUTE MAXIMUM RATINGS

(Note 1)

| | |
|---|------------------------------|
| V_{CC} to GND | -0.5V to 7.5V |
| TTL Input Voltage, REFHI, REFLO, X1/X2 | -0.5V to 7.5V |
| V_{OUT} , REFOUT | -0.5V to ($V_{CC} + 0.5V$) |
| Operating Temperature Range | |
| LTC1657C/LTC1657LC | 0°C to 70°C |
| LTC1657I/LTC1657LI | -40°C to 85°C |
| Maximum Junction Temperature | 125°C |
| Storage Temperature Range | -65°C to 150°C |
| Lead Temperature (Soldering, 10 sec) | 300°C |

PACKAGE/ORDER INFORMATION

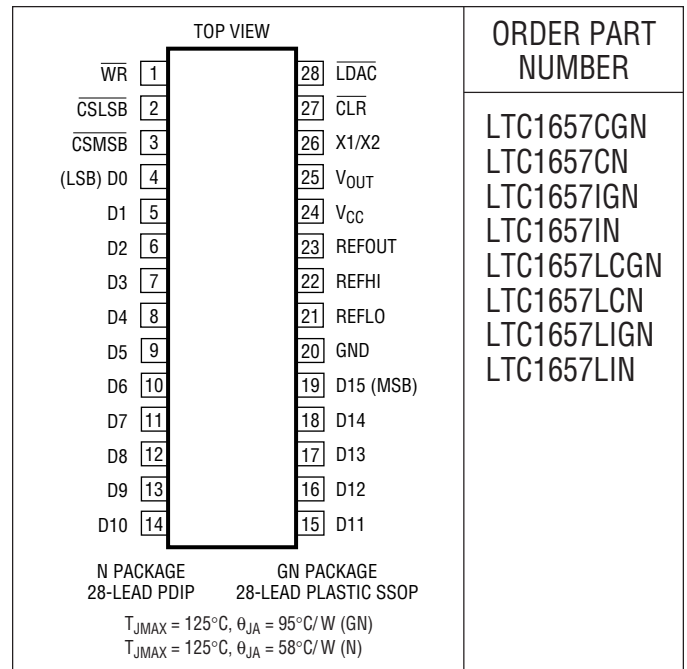

ORDER PART NUMBER

LTC1657CGN
LTC1657CN
LTC1657IGN
LTC1657IN
LTC1657LCGN
LTC1657LCN
LTC1657LIGN
LTC1657LIN

Consult factory for parts specified with wider operating temperature ranges.

ELECTRICAL CHARACTERISTICS The ● denotes specifications which apply over the full operating temperature range, otherwise specifications are at $T_A = 25^{\circ}C$. $V_{CC} = 4.5V$ to $5.5V$ (LTC1657), $V_{CC} = 2.7V$ to $5.5V$ (LTC1657L), V_{OUT} unloaded, REFOUT tied to REFHI, REFLO tied to GND, X1/X2 tied to GND, unless otherwise noted.

| SYMBOL | PARAMETER | CONDITIONS | MIN | TYP | MAX | UNITS |
|---------------------|---------------------------|--------------------------------------|-----|------|------|-------------------|
| DAC (Note 2) | | | | | | |
| | Resolution | | ● | 16 | | Bits |
| | Monotonicity | | ● | 16 | | Bits |
| DNL | Differential Nonlinearity | Guaranteed Monotonic (Note 3) | ● | ±0.5 | ±1 | LSB |
| INL | Integral Nonlinearity | (Note 3) | ● | ±4 | ±12 | LSB |
| ZSE | Zero Scale Error | | ● | 0 | 2 | mV |
| V_{OS} | Offset Error | Measured at Code 200 (LTC1657) | ● | ±0.3 | ±3 | mV |
| | | Measured at Code 200 (LTC1657L) | ● | ±0.4 | ±4 | mV |
| V_{OSTC} | Offset Error Tempco | | | ±5 | | $\mu V/^{\circ}C$ |
| | Gain Error | | ● | ±2 | ±16 | LSB |
| | Gain Error Drift | LTC1657 | | 0.5 | | ppm/ $^{\circ}C$ |
| | | LTC1657L | | 1.0 | | ppm/ $^{\circ}C$ |
| Power Supply | | | | | | |
| V_{CC} | Positive Supply Voltage | For Specified Performance (LTC1657) | ● | 4.5 | 5.5 | V |
| | | For Specified Performance (LTC1657L) | ● | 2.7 | 5.5 | V |
| I_{CC} | Supply Current | (Note 4) | ● | 650 | 1200 | μA |

ELECTRICAL CHARACTERISTICS The ● denotes specifications which apply over the full operating temperature range, otherwise specifications are at $T_A = 25^\circ\text{C}$. $V_{CC} = 4.5\text{V to }5.5\text{V}$ (LTC1657), $V_{CC} = 2.7\text{V to }5.5\text{V}$ (LTC1657L), V_{OUT} unloaded, REFOUT tied to REFHI, REFLO tied to GND, X1/X2 tied to GND, unless otherwise noted.

| SYMBOL | PARAMETER | CONDITIONS | MIN | TYP | MAX | UNITS | |
|----------------------------------|--|---|--------|----------------|------------------------------|--|--------|
| Op Amp DC Performance | | | | | | | |
| | Short-Circuit Current Low | V_{OUT} Shorted to GND | ● | 70 | 120 | mA | |
| | Short-Circuit Current High | V_{OUT} Shorted to V_{CC} | ● | 80 | 140 | mA | |
| | Output Impedance to GND | Input Code = 0 (LTC1657) Input Code = 0 (LTC1657L) | ● ● | 40 120 | 120 275 | Ω Ω | |
| | Output Line Regulation | Input Code = 65535, LTC1657: $V_{CC} = 4.5\text{V to }5.5\text{V}$ Input Code = 65535, LTC1657L: $V_{CC} = 2.7\text{V to }5.5\text{V}$ | ● ● | | 4 3 | mV/V mV/V | |
| AC Performance | | | | | | | |
| | Voltage Output Slew Rate | (Note 5) | ● | ± 0.3 | ± 0.7 | V/ μs | |
| | Voltage Output Settling Time | (Note 5) to 0.0015% (16-Bit Settling Time) (Note 5) to 0.012% (13-Bit Settling Time) | | 20 10 | | μs μs | |
| | Digital Feedthrough | (Note 6) | | 0.3 | | nV•s | |
| | Midscale Glitch Impulse | DAC Switch Between 8000 _H and 7FFF _H | | 8 | | nV•s | |
| | Output Voltage Noise Using Internal Reference at 1kHz | X1/X2 Tied to V_{OUT} (Notes 8, 9) LTC1657 LTC1657L | | 165 105 | | $\text{nV}/\sqrt{\text{Hz}}$ $\text{nV}/\sqrt{\text{Hz}}$ | |
| | Output Voltage Noise Using External Reference at 1kHz | X1/X2 Tied to V_{OUT} (Notes 8, 9, 10) | | 50 | | $\text{nV}/\sqrt{\text{Hz}}$ | |
| | Output Voltage Noise Density Using Internal Reference from 0.1Hz to 10Hz | X1/X2 Tied to V_{OUT} (Notes 8, 9) | | 8 | | μV_{P-P} | |
| | Reference Input Multiplying BW | | | 700 | | kHz | |
| Reference Output (REFOUT) | | | | | | | |
| | Reference Output Voltage | LTC1657 LTC1657L | ● ● | 2.036 1.240 | 2.048 1.250 | 2.060 1.260 | V V |
| | Reference Output Temperature Coefficient | | | 15 | | ppm/ $^\circ\text{C}$ | |
| | Reference Line Regulation | LTC1657: $V_{CC} = 4.5\text{V to }5.5\text{V}$ LTC1657L: $V_{CC} = 2.7\text{V to }5.5\text{V}$ | ● ● | | ± 1.5 ± 1.0 | mV/V mV/V | |
| | Reference Load Regulation | Measured at $I_{OUT} = 100\mu\text{A}$ (LTC1657) Measured at $I_{OUT} = 100\mu\text{A}$ (LTC1657L) | ● ● | | 5 3 | mV/A mV/A | |
| | Short-Circuit Current | REFOUT Shorted to GND | ● | 50 | 100 | mA | |
| | Reference Output Voltage Noise at 1kHz | LTC1657 LTC1657L | | 150 90 | | $\text{nV}/\sqrt{\text{Hz}}$ $\text{nV}/\sqrt{\text{Hz}}$ | |
| | Reference Output Voltage Noise Density from 0.1Hz to 10Hz | | | 6 | | μV_{P-P} | |
| Reference Input | | | | | | | |
| | REFHI, REFLO Input Range | (Note 7) See Applications Information X1/X2 Tied to V_{OUT} X1/X2 Tied to GND | ● ● | 0 0 | $V_{CC} - 1.5$ $V_{CC}/2$ | V V | |
| | REFHI Input Resistance | LTC1657 LTC1657L (Relative to REFLO) | ● ● | 16 16 | 25 23 | k Ω k Ω | |

LTC1657/LTC1657L

ELECTRICAL CHARACTERISTICS

The ● denotes specifications which apply over the full operating temperature range $T_A = T_{MIN}$ to T_{MAX} . $V_{CC} = 5V$ (LTC1657), $V_{CC} = 3V$ (LTC1657L), unless otherwise noted.

| SYMBOL | PARAMETER | CONDITIONS | LTC1657 | | | LTC1657L | | | UNITS |
|----------------------------------|--|----------------------------|---------|-----|-----|----------|-----|-----|-------|
| | | | MIN | TYP | MAX | MIN | TYP | MAX | |
| Digital I/O | | | | | | | | | |
| V_{IH} | Digital Input High Voltage | | ● | 2.4 | | 2.0 | | | V |
| V_{IL} | Digital Input Low Voltage | | ● | | 0.8 | | 0.6 | | V |
| I_{LEAK} | Digital Input Leakage | $V_{IN} = GND$ to V_{CC} | ● | | ±10 | | ±10 | | μA |
| C_{IN} | Digital Input Capacitance | (Note 7) | ● | | 10 | | 10 | | pF |
| Switching Characteristics | | | | | | | | | |
| t_{CS} | \overline{CS} (MSB or LSB) Pulse Width | | ● | 40 | | 60 | | | ns |
| t_{WR} | \overline{WR} Pulse Width | | ● | 40 | | 60 | | | ns |
| t_{CWS} | \overline{CS} to \overline{WR} Setup | | ● | 0 | | 0 | | | ns |
| t_{CWH} | \overline{CS} to \overline{WR} Hold | | ● | 0 | | 0 | | | ns |
| t_{DWS} | Data Valid to \overline{WR} Setup | | ● | 40 | | 60 | | | ns |
| t_{DWH} | Data Valid to \overline{WR} Hold | | ● | 0 | | 0 | | | ns |
| t_{LDAC} | \overline{LDAC} Pulse Width | | ● | 40 | | 60 | | | ns |
| t_{CLR} | \overline{CLR} Pulse Width | | ● | 40 | | 60 | | | ns |

Note 1: Absolute Maximum Ratings are those values beyond which the life of a device may be impaired.

Note 2: External reference REFHI = 2.2V. $V_{CC} = 5V$ (LTC1657).
External reference REFHI = 1.3V. $V_{CC} = 3V$ (LTC1657L).

Note 3: Nonlinearity is defined from code 128 to code 65535 (full scale). See Applications Information.

Note 4: Digital inputs at 0V or V_{CC} .

Note 5: DAC switched between all 1s and all 0s. $V_{FS} = 4.096V$.

Note 6: D0 to D15 toggle between all 0s and all 1s with REFHI = 0V, $\overline{CSMSB} = \overline{CSLSB} = \overline{WR} = \overline{LDAC} = High$

Note 7: Guaranteed by design. Not subject to test.

Note 8: DAC inputs all 1s.

Note 9: X1/X2 tied to GND, the voltage noise will be a factor of 2 greater.

Note 10: Using 2.048V (1.25V) external reference with $3nV/\sqrt{Hz}$ noise at 1kHz for LTC1657/(LTC1657L).

TYPICAL PERFORMANCE CHARACTERISTICS

LTC1657 Differential Nonlinearity

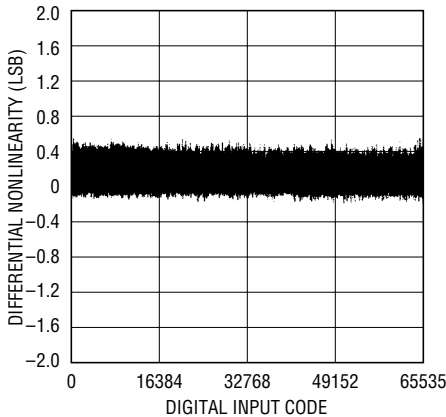

1657 G01

LTC1657L Differential Nonlinearity

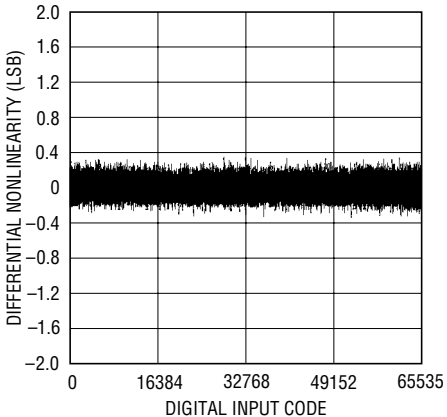

1657 G02

LTC1657 Integral Nonlinearity

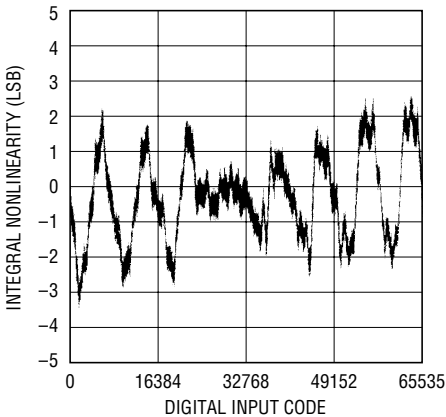

1657 G03

LTC1657L Integral Nonlinearity

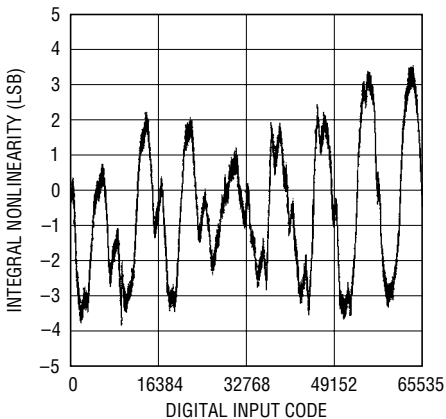

1657 G04

LTC1657 Minimum Supply Headroom for Full Output Swing vs Load Current

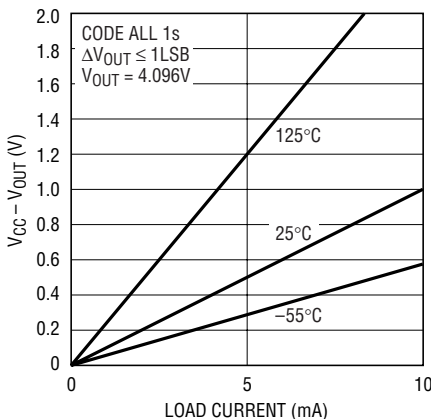

1657 G05

LTC1657L Minimum Supply Headroom for Full Output Swing vs Load Current

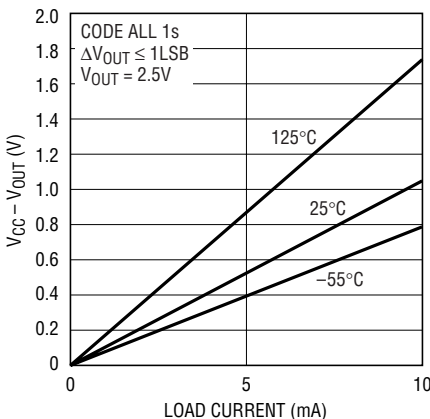

1657 G06

LTC1657 Minimum Output Voltage vs Output Sink Current

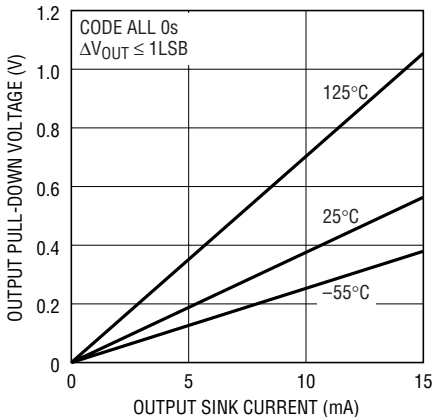

1657 G07

LTC1657L Minimum Output Voltage vs Output Sink Current

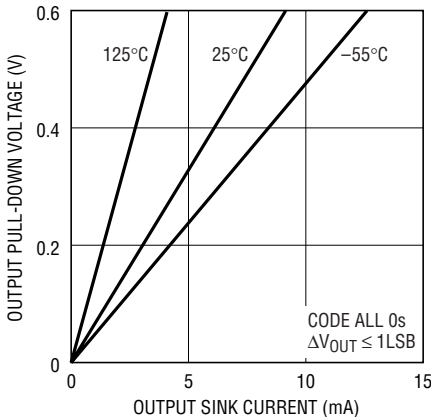

1657 G08

LTC1657 Full-Scale Voltage vs Temperature

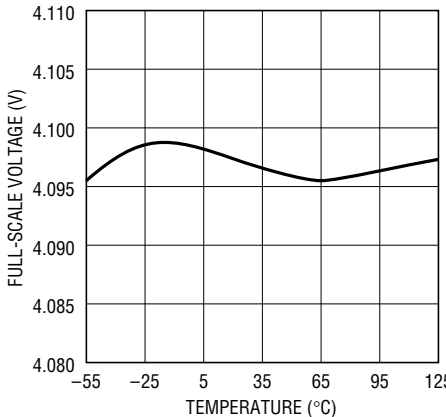

1657 G09

TYPICAL PERFORMANCE CHARACTERISTICS

LTC1657L Full-Scale Voltage vs Temperature

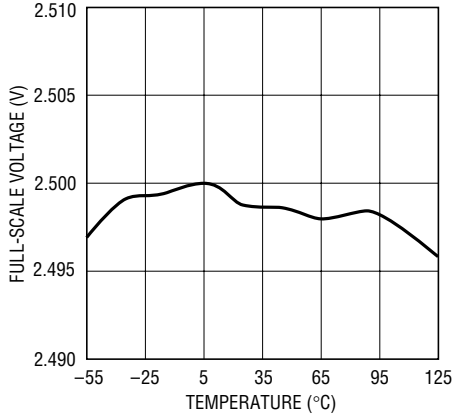

LTC1657 Offset Error vs Temperature

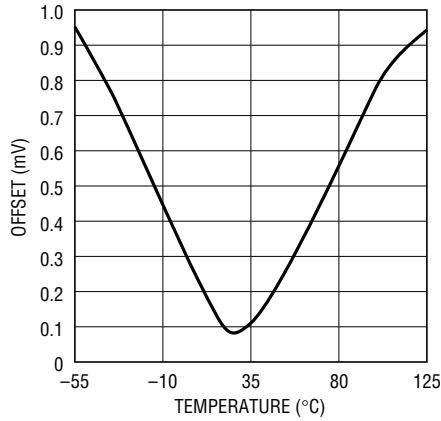

LTC1657L Offset Error vs Temperature

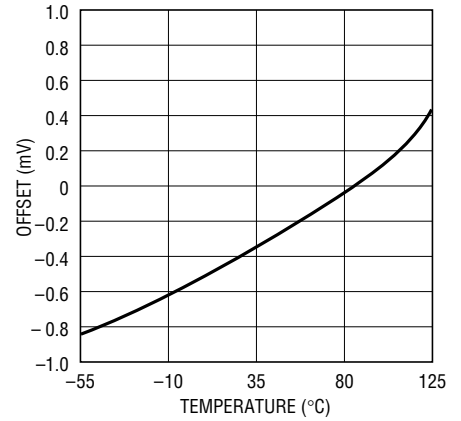

LTC1657 Supply Current vs Logic Input Voltage

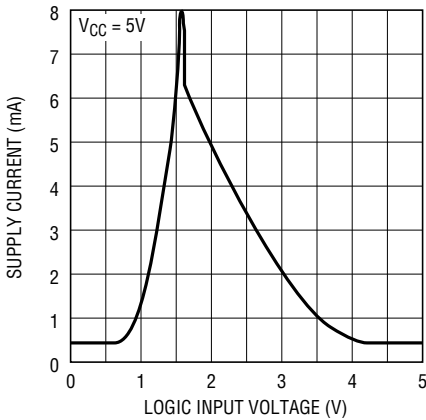

LTC1657L Supply Current vs Logic Input Voltage

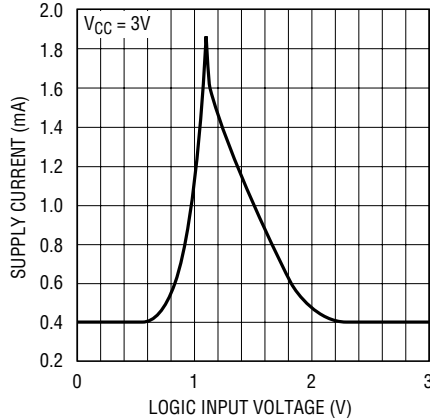

LTC1657 Supply Current vs Temperature

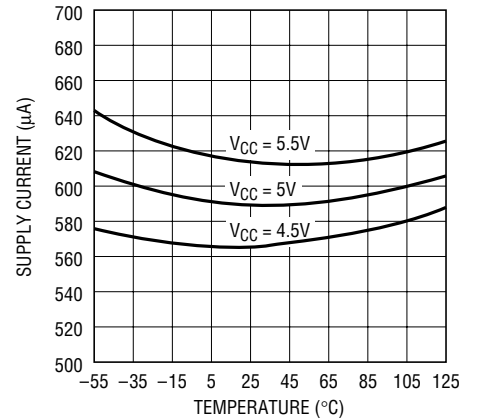

LTC1657L Supply Current vs Temperature

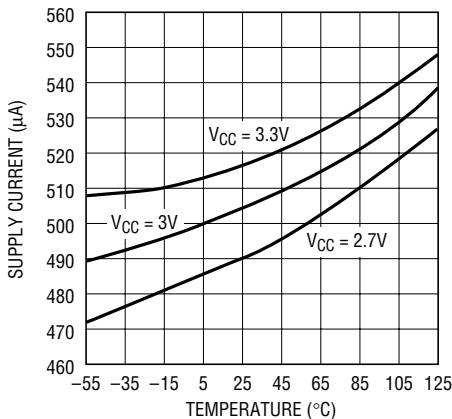

LTC1657 Large-Signal Transient Response

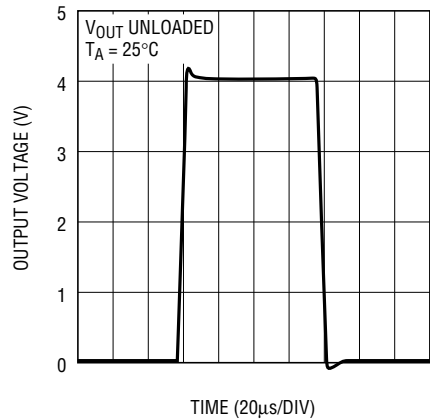

LTC1657L Large-Signal Transient Response

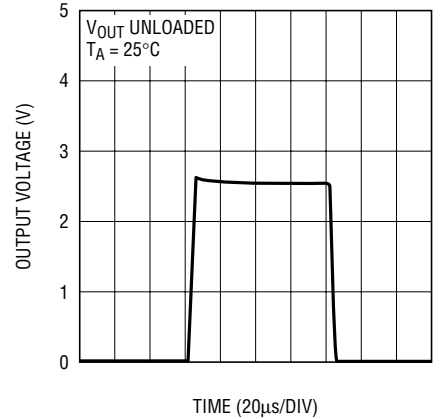

TYPICAL PERFORMANCE CHARACTERISTICS

LTC1657 0.1Hz to 10Hz
Voltage Noise

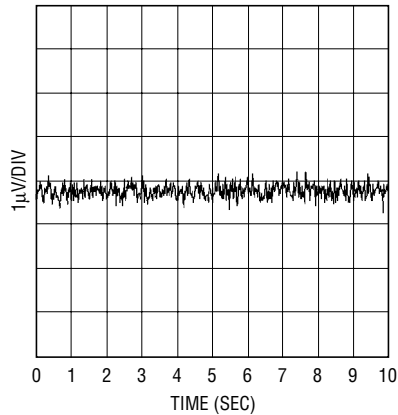

1659 G19

LTC1657L 0.1Hz to 10Hz
Voltage Noise

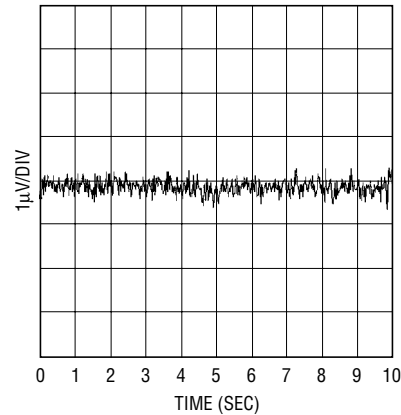

1659 G20

PIN FUNCTIONS

WR (Pin 1): Write Input (Active Low). Used with $\overline{\text{CSMSB}}$ and/or $\overline{\text{CSLSB}}$ to control the input registers. While $\overline{\text{WR}}$ and $\overline{\text{CSMSB}}$ and/or $\overline{\text{CSLSB}}$ are held low, data writes into the input register.

CSLSB (Pin 2): Chip Select Least Significant Byte (Active Low). Used with $\overline{\text{WR}}$ to control the LSB 8-bit input registers. While $\overline{\text{WR}}$ and $\overline{\text{CSLSB}}$ are held low, the LSB byte writes into the LSB input register. Can be connected to $\overline{\text{CSMSB}}$ for simultaneous loading of both sets of input latches on a 16-bit bus.

CSMSB (Pin 3): Chip Select Most Significant Byte (Active Low). Used with $\overline{\text{WR}}$ to control the MSB 8-bit input registers. While $\overline{\text{WR}}$ and $\overline{\text{CSMSB}}$ are held low, the MSB byte writes into the MSB input register. Can be connected to $\overline{\text{CSLSB}}$ for simultaneous loading of both sets of input latches on a 16-bit bus.

D0 to D7 (Pins 4 to 11): Input data for the Least Significant Byte. Written into LSB input register when $\overline{\text{WR}} = 0$ and $\overline{\text{CSLSB}} = 0$.

D8 to D15 (Pins 12 to 19): Input data for the Most Significant Byte. Written into MSB input register when $\overline{\text{WR}} = 0$ and $\overline{\text{CSMSB}} = 0$.

GND (Pin 20): Ground.

REFLO (Pin 21): Lower input terminal of the DAC's internal resistor ladder. Typically connected to Analog Ground. An input code of $(0000)_H$ will connect the positive input of the output buffer to this end of the ladder. Can be used to offset the zero scale above ground.

REFHI (Pin 22): Upper input terminal of the DAC's internal resistor ladder. Typically connected to REFOUT. An input code of $(FFFF)_H$ will connect the positive input of the output buffer to 1LSB below this voltage.

REFOUT (Pin 23): Output of the internal reference is 2.048V (LTC1657), 1.25V (LTC1657L). Typically connected to REFHI to drive internal DAC resistor ladder.

V_{CC} (Pin 24): Positive Power Supply Input. $4.5V \leq V_{CC} \leq 5.5V$ (LTC1657), $2.7V \leq V_{CC} \leq 5.5V$ (LTC1657L). Requires a $0.1\mu\text{F}$ bypass capacitor to ground.

V_{OUT} (Pin 25): Buffered DAC Output.

X1/X2 (Pin 26): Gain Setting Resistor Pin. Connect to GND for $G = 2$ or to V_{OUT} for $G = 1$. This pin should always be tied to a low impedance source, such as ground or V_{OUT} , to ensure stability of the output buffer when driving capacitive loads.

PIN FUNCTIONS

CLR (Pin 27): Clear Input (Asynchronous Active Low). A low on this pin asynchronously resets all input and DAC registers to 0s.

LDAC (Pin 28): Load DAC (Asynchronous Active Low). Used to asynchronously transfer the contents of the input registers to the DAC register which updates the output voltage. If held low, the DAC register loads data from the input registers which will immediately update V_{OUT} .

DIGITAL INTERFACE TRUTH TABLE

| CLR | CSMSB | CSLSB | WR | LDAC | FUNCTION |
|-----|-------|-------|----|------|---|
| L | X | X | X | X | Clears input and DAC registers to zero |
| H | X | X | X | L | Loads DAC register with contents of input registers |
| H | X | X | X | H | Freezes contents of DAC register |
| H | L | H | L | X | Writes MSB byte into MSB input register |
| H | H | L | L | X | Writes LSB byte into LSB input register |
| H | L | L | L | X | Writes MSB and LSB bytes into MSB and LSB input registers |
| H | X | X | H | X | Inhibits write to MSB and LSB input registers |
| H | H | X | X | X | Inhibits write to MSB input register |
| H | X | H | X | X | Inhibits write to LSB input register |
| H | L | L | L | L | Data bus flows directly through input and DAC registers |

TIMING DIAGRAM

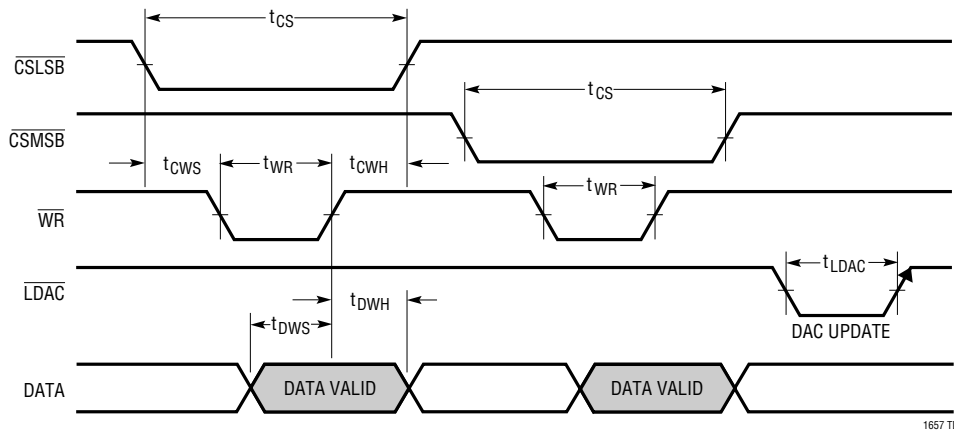

DEFINITIONS

Resolution (n): Resolution is defined as the number of digital input bits (n). It defines the number of DAC output states (2^n) that divide the full-scale range. Resolution does not imply linearity.

Full-Scale Voltage (V_{FS}): This is the output of the DAC when all bits are set to 1.

Voltage Offset Error (V_{OS}): Normally, the DAC offset is the voltage at the output when the DAC is loaded with all zeros. The DAC can have a true negative offset, but because the part is operated from a single supply, the output cannot go below zero. If the offset is negative, the output will remain near 0V resulting in the transfer curve shown in Figure 1.

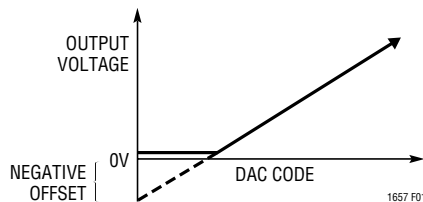

Figure 1. Effect of Negative Offset

The offset of the part is measured at the code that corresponds to the maximum offset specification:

$$V_{OS} = V_{OUT} - [(Code)(V_{FS})/(2^n - 1)]$$

Least Significant Bit (LSB): One LSB is the ideal voltage difference between two successive codes.

$$LSB = G \cdot V_{REF}/65536$$

G = 1 for X1/X2 connected to V_{OUT}

G = 2 for X1/X2 connected to GND

Nominal LSBs: (V_{REFOUT} tie to V_{REFHI} , REFLO tie to GND, G = 2)

$$LTC1657 \text{ LSB} = 4.096V/65536 = 62.5\mu V$$

$$LTC1657L \text{ LSB} = 2.5V/65536 = 38.1\mu V$$

DAC Transfer Characteristic:

$$V_{OUT} = G \cdot \left(\frac{REFHI - REFLO}{65536} \right) (CODE) + REFLO$$

G = 1 for X1/X2 connected to V_{OUT}

G = 2 for X1/X2 connected to GND

CODE = Decimal equivalent of digital input
($0 \leq CODE \leq 65535$)

Zero-Scale Error (ZSE): The output voltage when the DAC is loaded with all zeros. Since this is a single supply part, this value cannot be less than 0V.

Integral Nonlinearity (INL): End-point INL is the maximum deviation from a straight line passing through the end points of the DAC transfer curve. Because the part operates from a single supply and the output cannot go below zero, the linearity is measured between full scale and the code corresponding to the maximum offset specification. The INL error at a given input code is calculated as follows:

$$INL \text{ (In LSBs)} = [V_{OUT} - V_{OS} - (V_{FS} - V_{OS}) \cdot (code/65535)]$$

V_{OUT} = The output voltage of the DAC measured at the given input code

Differential Nonlinearity (DNL): DNL is the difference between the measured change and the ideal one LSB change between any two adjacent codes. The DNL error between any two codes is calculated as follows:

$$DNL = (\Delta V_{OUT} - LSB)/LSB$$

ΔV_{OUT} = The measured voltage difference between two adjacent codes

Digital Feedthrough: The glitch that appears at the analog output caused by AC coupling from the digital inputs when they change state. The area of the glitch is specified in $nV \cdot s$.

OPERATION

Parallel Interface

The data on the input of the DAC is written into the DAC's input registers when Chip Select ($\overline{\text{CSLSB}}$ and/or $\overline{\text{CSMSB}}$) and $\overline{\text{WR}}$ are at a logic low. The data that is written into the input registers will depend on which of the Chip Selects are at a logic low (see Digital Interface Truth Table). If $\overline{\text{WR}}$ and $\overline{\text{CSLSB}}$ are both low and $\overline{\text{CSMSB}}$ is high, then only data on the eight LSBs (D0 to D7) is written into the input registers. Similarly, if $\overline{\text{WR}}$ and $\overline{\text{CSMSB}}$ are both low and $\overline{\text{CSLSB}}$ is high, then only data on the eight MSBs (D8 to D15) is written into the input registers. Data is written into both the Least Significant Data Bits (D0 to D7) and the Most Significant Bits (D8 to D15) at the same time if $\overline{\text{WR}}$, $\overline{\text{CSLSB}}$ and $\overline{\text{CSMSB}}$ are low. If $\overline{\text{WR}}$ is high or both $\overline{\text{CSMSB}}$ and $\overline{\text{CSLSB}}$ are high, then no data is written into the input registers.

Once data is written into the input registers, it can be written into the DAC register. This will update the analog voltage output of the DAC. The DAC register is written by a logic low on $\overline{\text{LDAC}}$. The data in the DAC register will be held when $\overline{\text{LDAC}}$ is high.

When $\overline{\text{WR}}$, $\overline{\text{CSLSB}}$, $\overline{\text{CSMSB}}$ and $\overline{\text{LDAC}}$ are all low, the registers are transparent and data on pins D0 to D15 flows directly into the DAC register.

For an 8-bit data bus connection, tie the MSB byte data pins to their corresponding LSB byte pins (D15 to D7, D14 to D6, etc).

Power-On Reset

The LTC1657/LTC1657L have an internal power-on reset that resets all internal registers to 0's on power-up and V_{OUT} pin forces to GND (equivalent to the CLR pin function).

Reference

The LTC1657/LTC1657L include an internal 2.048V/1.25V reference, giving the LTC1657/LTC1657L a full-scale range of 4.096V/2.5V in the gain-of-2 configuration. The onboard reference in the LTC1657/LTC1657L is not internally connected to the DAC's reference resistor string but is provided on an adjacent pin for flexibility. Because the internal reference is not internally connected to the DAC

resistor ladder, an external reference can be used or the resistor ladder can be driven by an external source in multiplying applications. The external reference or source must be capable of driving the 16k (minimum) DAC ladder resistance.

Internal reference output noise can be reduced with a bypass capacitor to ground. (Note: The reference does not require a bypass capacitor to ground for nominal operation.) When bypassing the reference, a small value resistor in series with the capacitor is recommended to help reduce peaking on the output. A 10 Ω resistor in series with a 4.7 μF capacitor is optimum for reducing reference generated noise. Internal reference output voltage noise spectral density at 1kHz is typically 150nV/ $\sqrt{\text{Hz}}$ (LTC1657), 90nV/ $\sqrt{\text{Hz}}$ (LTC1657L)

DAC Resistor Ladder

The high and low end of the DAC ladder resistor string (REFHI and REFLO, respectively) are not connected internally on this part. Typically, REFHI will be connected to REFOUT and REFLO will be connected to GND. X1/X2 connected to GND will give the LTC1657/LTC1657L a full-scale output swing of 4.096V/2.5V.

Either of these pins can be driven up to $V_{\text{CC}} - 1.5\text{V}$ when using the buffer in the gain-of-1 configuration. The resistor string pins can be driven to $V_{\text{CC}}/2$ when the buffer is in the gain of 2 configuration. The resistance between these two pins is typically 25k (16k min) (LTC1657), 23k (16k min) (LTC1657L).

Voltage Output

The output buffer for the LTC1657/LTC1657L can be configured for two different gain settings. By tying the X1/X2 pin to GND, the gain is set to 2. By tying the X1/X2 pin to V_{OUT} , the gain is set to unity.

The LTC1657/LTC1657L rail-to-rail buffered output can source or sink 5mA within 500mV of the positive supply voltage or ground at room temperature. The output stage is equipped with a deglitcher that results in a midscale glitch impulse of 8nV•s. The output swings to within a few millivolts of either supply rail when unloaded and has an equivalent output resistance of 40 Ω (LTC1657), 120 Ω (LTC1657L) when driving a load to the rails.

APPLICATIONS INFORMATION

Rail-to-Rail Output Considerations

In any rail-to-rail DAC, the output swing is limited to voltages within the supply range.

If the DAC offset is negative, the output for the lowest codes limits at 0V as shown in Figure 1b.

Similarly, limiting can occur near full scale when the REF pin is tied to $V_{CC}/2$. If $V_{REF} = V_{CC}/2$ and the DAC full-scale error (FSE) is positive, the output for the highest codes limits at V_{CC} as shown in Figure 1c. No full-scale limiting can occur if V_{REF} is less than $(V_{CC} - FSE)/2$.

Offset and linearity are defined and tested over the region of the DAC transfer function where no output limiting can occur.

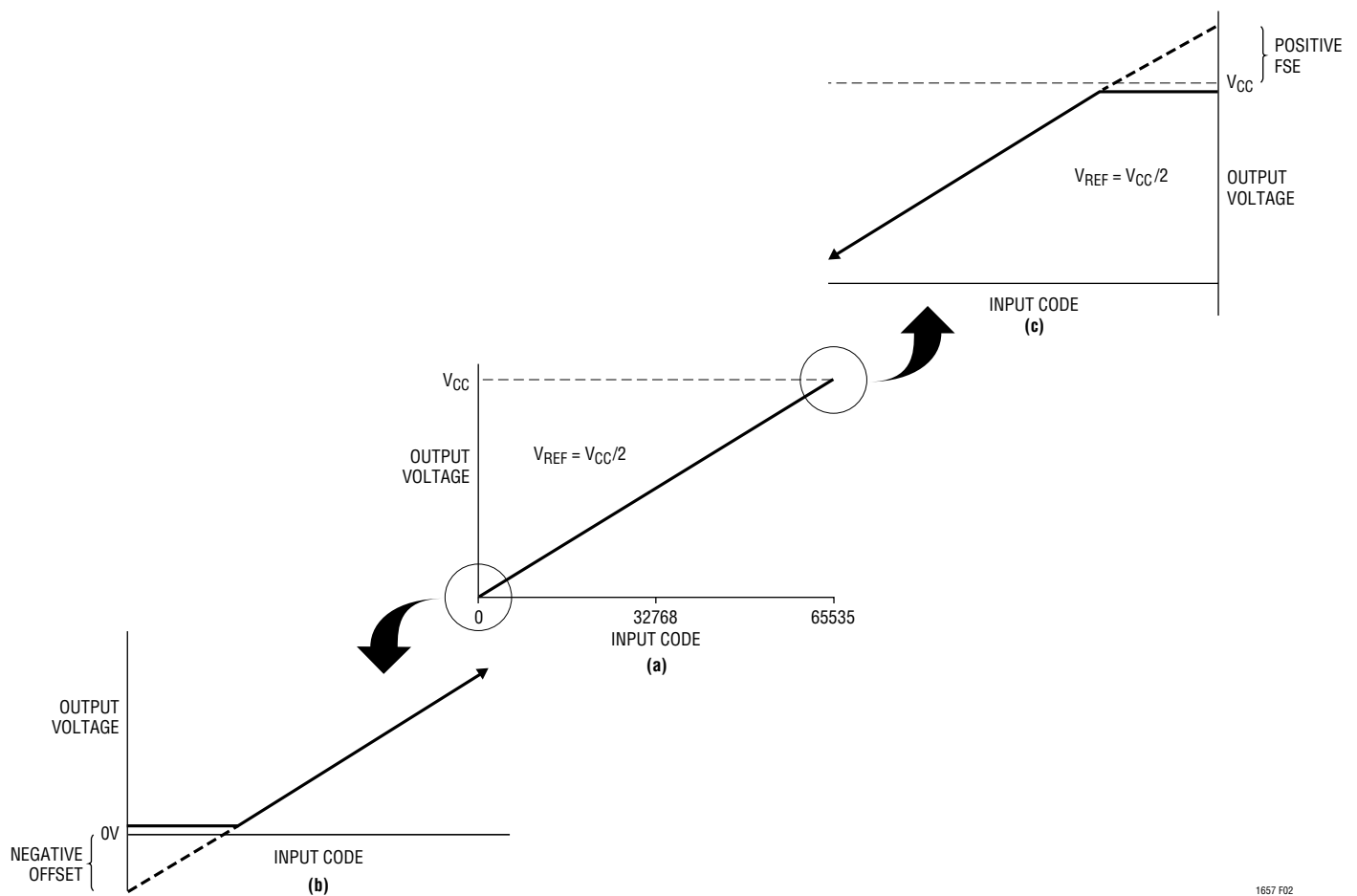

Figure 2. Effects of Rail-to-Rail Operation On a DAC Transfer Curve. (a) Overall Transfer Function (b) Effect of Negative Offset for Codes Near Zero Scale (c) Effect of Positive Full-Scale Error for Input Codes Near Full Scale When $V_{REF} = V_{CC}/2$

TYPICAL APPLICATIONS

This circuit shows how to make a bipolar output 16-bit DAC with a wide output swing using an LTC1657 and an LT1077. R1 and R2 resistively divide down the LTC1657 output and an offset is summed in using the LTC1657 onboard 2.048V reference and R3 and R4. R5 ensures that

the onboard reference is always sourcing current and never has to sink any current even when V_{OUT} is at full scale. The LT1077 output will have a wide bipolar output swing of $-4.096V$ to $4.096V$ as shown in the figure below. With this output swing, $1LSB = 125\mu V$.

A Wide Swing, Bipolar Output 16-Bit DAC

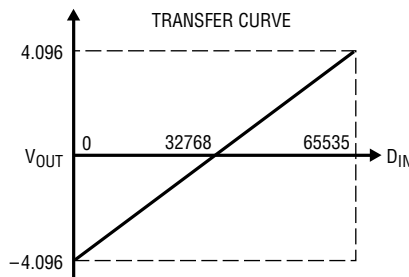
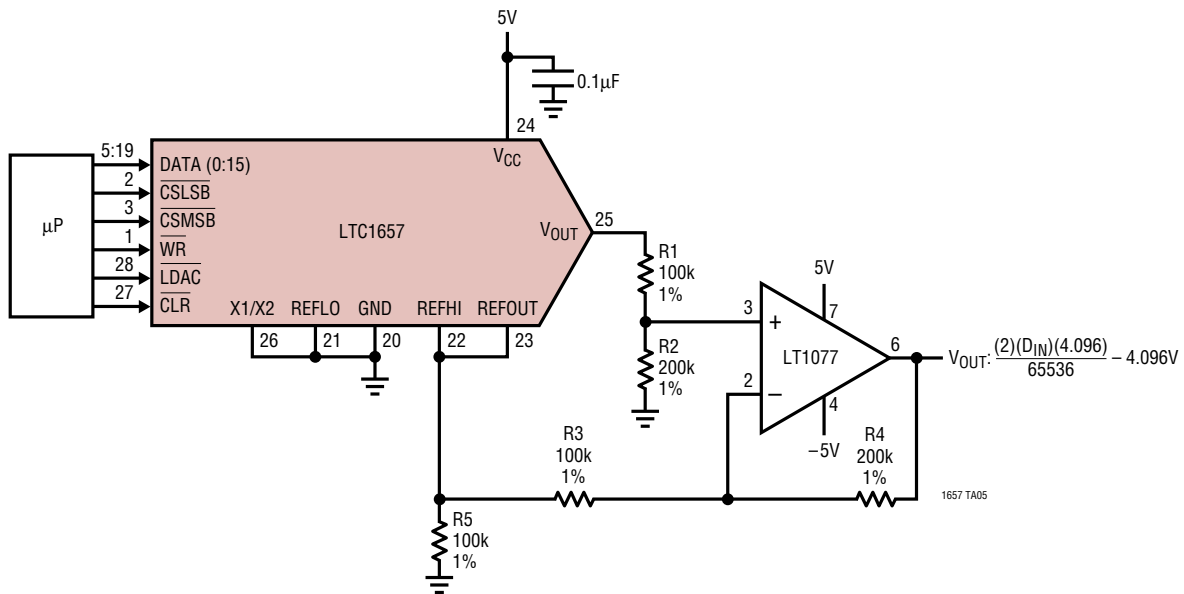

TYPICAL APPLICATIONS

This circuit shows a digitally programmable current source from an external voltage source using an external op amp, an LT1218 and an NPN transistor (2N3440). Any digital word from 0 to 65535 is loaded into the LTC1657 and its output correspondingly swings from 0V to 4.096V. This voltage will be forced across the resistor R_A . If R_A is

chosen to be 412Ω , the output current will range from 0mA at zero scale to 10mA at full scale. The minimum voltage for V_S is determined by the load resistor R_L and Q1's V_{CESAT} voltage. With a load resistor of 50Ω , the voltage source can be 5V.

Digitally Programmable Current Source

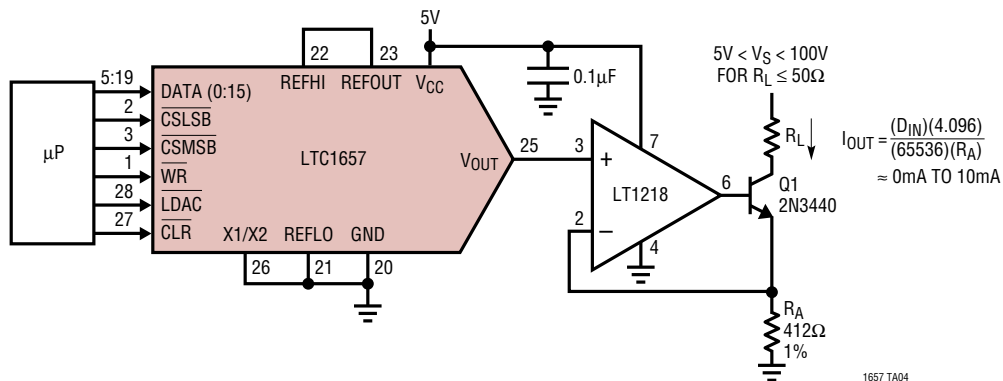

PACKAGE DESCRIPTION

Dimensions in inches (millimeters) unless otherwise noted.

GN Package
28-Lead Plastic SSOP (Narrow 0.150)
 (LTC DWG # 05-08-1641)

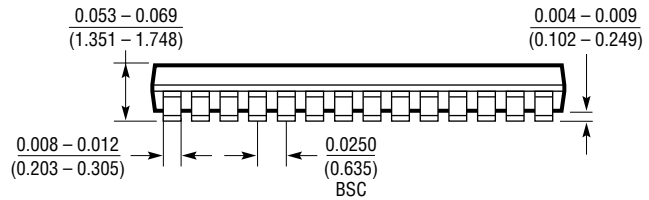
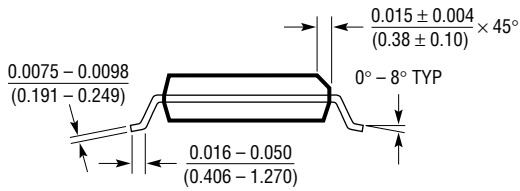
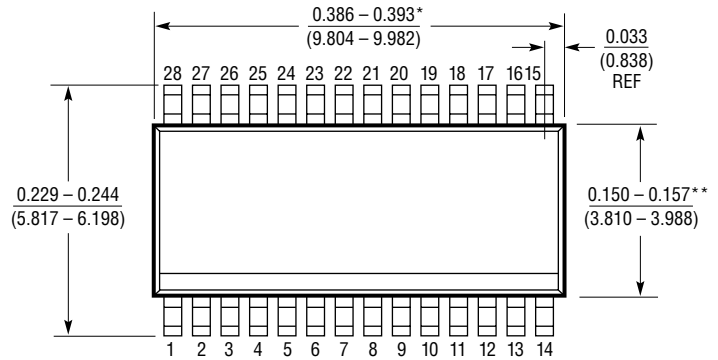

* DIMENSION DOES NOT INCLUDE MOLD FLASH. MOLD FLASH SHALL NOT EXCEED 0.006" (0.152mm) PER SIDE

** DIMENSION DOES NOT INCLUDE INTERLEAD FLASH. INTERLEAD FLASH SHALL NOT EXCEED 0.010" (0.254mm) PER SIDE

GN28 (SSOP) 1098

PACKAGE DESCRIPTION Dimensions in inches (millimeters) unless otherwise noted.

N Package
28-Lead PDIP (Narrow 0.300)
 (LTC DWG # 05-08-1510)

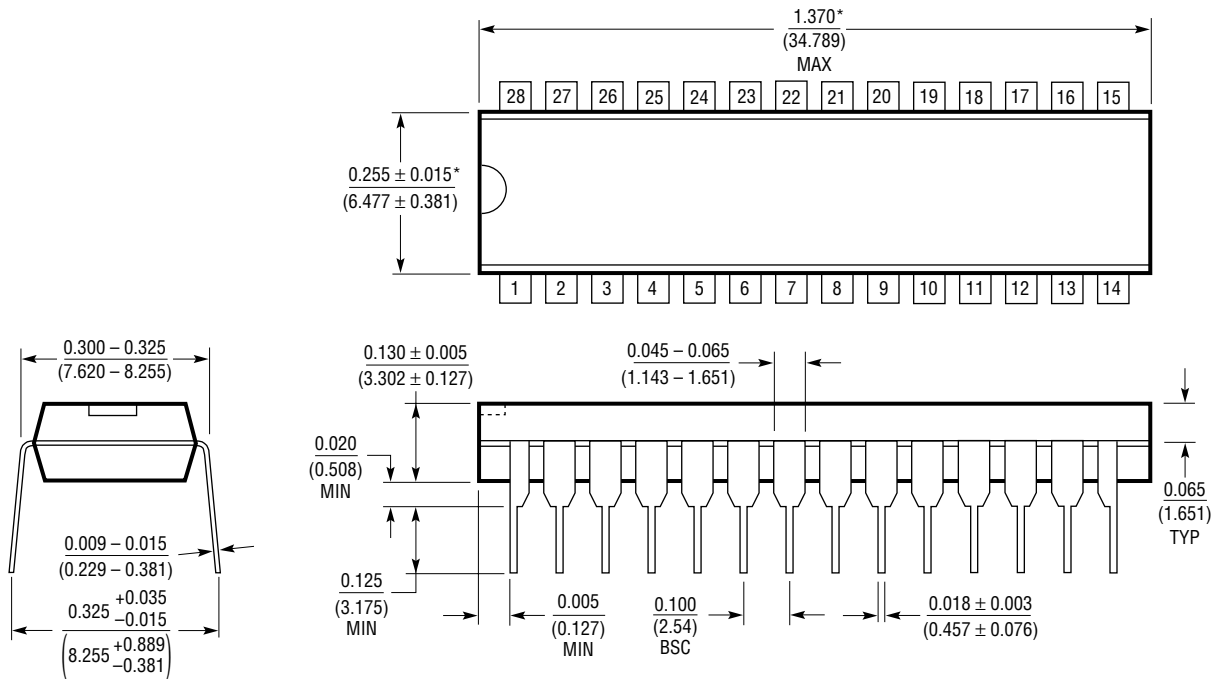

*THESE DIMENSIONS DO NOT INCLUDE MOLD FLASH OR PROTRUSIONS.
 MOLD FLASH OR PROTRUSIONS SHALL NOT EXCEED 0.010 INCH (0.254mm)

N28 1098

LTC1657/LTC1657L

TYPICAL APPLICATIONS

This circuit shows how to measure negative offset. Since LTC1657/LTC1657L operate on a single supply, if their offset is negative, the output for code 0 limits at 0V. To

measure this negative offset, a negative supply is needed, connect resistor R1 as shown in the figure. The output voltage is the offset when code 0 is loaded in.

Negative Offset Measurement

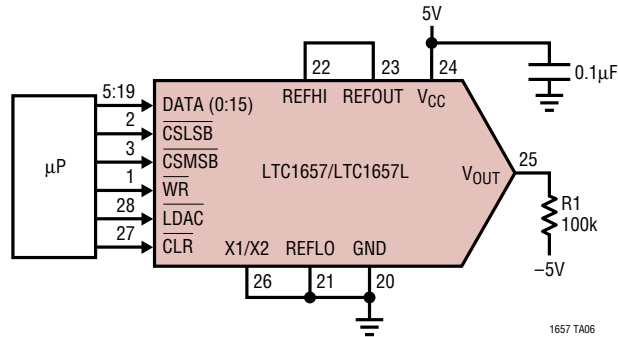

Although LTC1657 output is up to 4.096V with its internal reference, higher voltages can be achieved with the help of another op amp. The following circuit shows how to increase the output swing of LTC1657 by using an LT1218.

As shown in the configuration, the output of LTC1657 is amplified by 8 for an output swing of 0V to 32.768V, or a convenient 0.5mV/LSB.

A Higher Voltage Output DAC

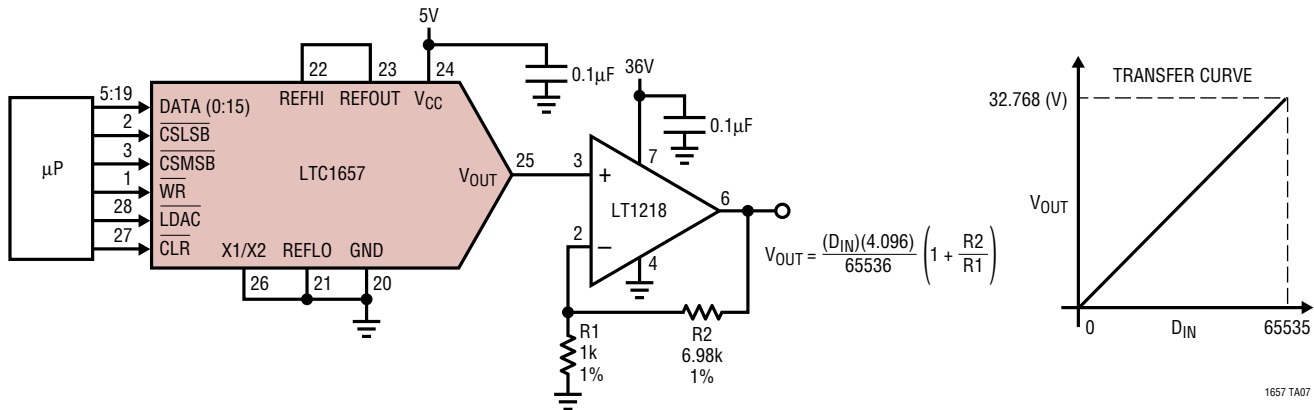

RELATED PARTS

| PART NUMBER | DESCRIPTION | COMMENTS |
|-------------|--|--|
| LTC1446(L) | Dual 12-Bit V _{OUT} DACs in SO-8 Package | V _{CC} = 5V (3V), V _{OUT} = 0V to 4.095V (0V to 2.5V) |
| LTC1450(L) | Single 12-Bit V _{OUT} DACs with Parallel Interface | V _{CC} = 5V (3V), V _{OUT} = 0V to 4.095V (0V to 2.5V) |
| LTC1458(L) | Quad 12-Bit Rail-to-Rail Output DACs with Added Functionality | V _{CC} = 5V (3V), V _{OUT} = 0V to 4.095V (0V to 2.5V) |
| LTC1650 | Single 16-Bit V _{OUT} Industrial DAC in 16-Pin SO | V _{CC} = ±5V, Low Power, Deglitched, 4-Quadrant Multiplying V _{OUT} |
| LTC1654 | Dual 14-Bit V _{OUT} DAC | Programmable Speed/Power, SO-8 Footprint |
| LTC1655(L) | Single 16-Bit V _{OUT} DAC with Serial Interface in SO-8 | V _{CC} = 5V (3V), Low Power, Deglitched, V _{OUT} = 0V to 4.096V (0V to 2.5V) |
| LTC1658 | Single 14-Bit V _{OUT} DAC in MSOP Package | 2.7V to 5.5V Operation, Low Power |