



# MAQ5281

120V<sub>IN</sub>, 25mA, Ultra-Low I<sub>Q</sub>, High-PSRR  
Linear Regulator

Automotive

## General Description

The MAQ5281 high-performance linear regulator offers a very-wide input operating voltage range, up to 120V DC, and supplies an output current of up to 25mA.

Ideal for high input voltage applications such as automotive, industrial and telecom, the MAQ5281 offers  $\pm 3\%$  initial accuracy, extremely high-power supply rejection ratio (>90db) and ultra-low quiescent current of 6 $\mu$ A. The MAQ5281 is optimized for high-voltage line transients, making it ideal for harsh environment applications.

The MAQ5281 is offered in both fixed output voltage (3.3V/5.0V) and adjustable output voltage (1.27V to 5.5V) options.

The MAQ5281 operates over a  $-40^{\circ}\text{C}$  to  $+125^{\circ}\text{C}$  temperature range and is available in lead-free, RoHS-compliant, 8-pin ePad MSOP package. This part is also AEC-Q100 qualified for automotive applications.

Data sheet and support documentation are found on the Micrel website: [www.micrel.com](http://www.micrel.com).

## Features

- AEC-Q100 qualified
- Wide input voltage range: 6V to 120V DC
- Ultra-low quiescent current: 6 $\mu$ A (typ)
- 25mA guaranteed output current
- Adjustable output from 1.27V to 5.5V
- Withstands up to +120V DC at the input
- Stable with ceramic capacitors
- Ultra-high PSRR >90dB
- Ultra-high line transient rejection (load dump)
- High output accuracy:
  - $\pm 3\%$  initial accuracy
- Thermal-shutdown and current-limit protection
- Thermally-efficient, 8-pin ePad MSOP package

## Applications

- Automotive
- Remote keyless entry power supply
- Telecom applications

## Typical Applications

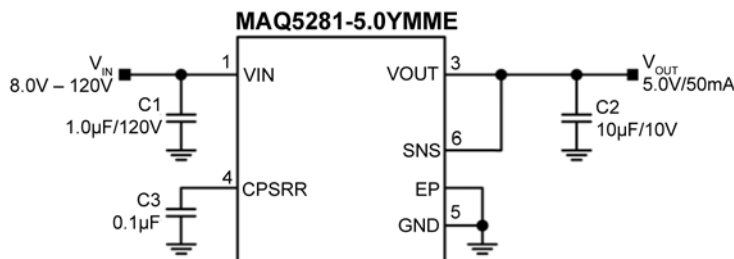
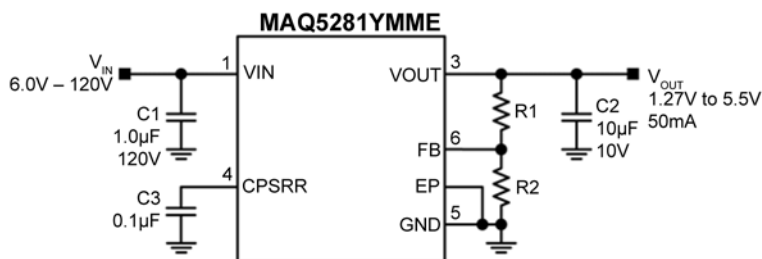

Quiescent Supply Current vs. Input Voltage

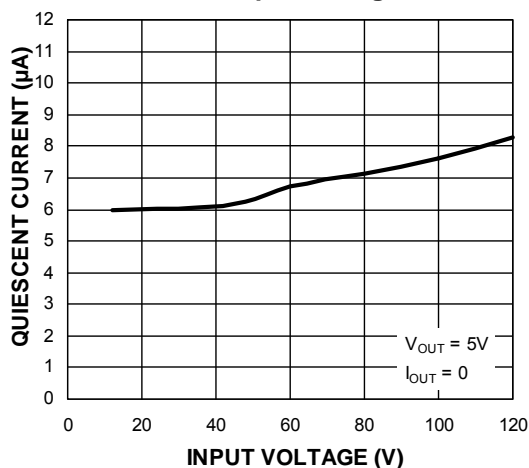

## Ordering Information

Part Number	Output Voltage	Top Mark	Temperature Range	Package	Lead Finish
MAQ5281YMME	Adjustable	7Q1A	-40°C to +125°C	8-Pin ePad MSOP	Pb-Free
MAQ5281-3.3YMME	3.3V	7Q1S	-40°C to +125°C	8-Pin ePad MSOP	Pb-Free
MAQ5281-5.0YMME	5.0V	7Q15	-40°C to +125°C	8-Pin ePad MSOP	Pb-Free

## Pin Configuration

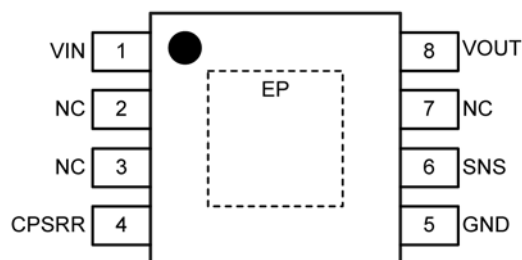

8-Pin ePAD MSOP  
MAQ5281-x.xYMME

(TOP VIEW)

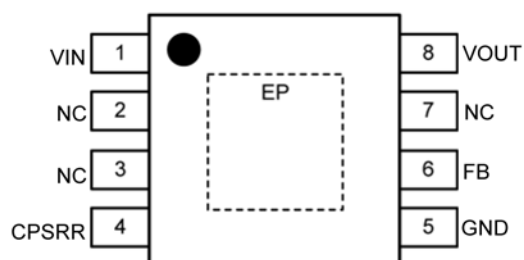

8-Pin ePAD MSOP  
MAQ5281YMME

(TOP VIEW)

## Pin Description

Pin		Name	Function
MAQ5281YMME	MAQ5281-x.xYMME		
1	1	VIN	Supply Voltage Input. Connect 1 $\mu$ F capacitor from VIN to GND.
2, 3, 7	2, 3, 7	NC	Not internally connected. Connect NC to GND or leave unconnected.
4	4	CPSRR	Bypass Capacitor Connection. Connect 0.1 $\mu$ F capacitor from CPSRR to GND.
5	5	GND	Ground.
6	–	FB	Feedback Connection. For external resistor divider to set V <sub>OUT</sub> .
–	6	SNS	Sense input. Connect SNS to V <sub>OUT</sub> .
8	8	VOUT	Regulator Output. Connect 10 $\mu$ F capacitor from V <sub>OUT</sub> to GND.
EP	EP	ePad	Exposed Pad (ePad) for Thermal Relief. Connect EP to GND.

**Absolute Maximum Ratings<sup>(1)</sup>**

$V_{IN}$ to GND.....	-0.3V to +125V
$V_{CPSRR}$ to GND.....	-0.3 to +14V
$V_{FB}$ , $V_{SNS}$ , $V_{OUT}$ to GND .....	-0.3V to +6V
Power Dissipation ( $P_D$ ).....	Internally Limited <sup>(3)</sup>
Lead Temperature (soldering, 10s).....	+260°C
Junction Temperature .....	$-40^{\circ}\text{C} \leq T_J \leq +125^{\circ}\text{C}$
Storage Temperature .....	$-65^{\circ}\text{C} \leq T_A \leq +150^{\circ}\text{C}$
<b>ESD Ratings<sup>(4)</sup></b>	
HBM.....	2kV
MM.....	200V

**Operating Ratings<sup>(2)</sup>**

$V_{IN}$ .....	+6V to +120V
$V_{OUT}$ Adjust Range .....	+1.27V to +5.5V
Junction Temperature .....	$-40^{\circ}\text{C} \leq T_J \leq +125^{\circ}\text{C}$
<b>Junction Thermal Resistance (<math>\theta_{JA}</math>)</b>	
8-pin ePad MSOP.....	64°C/W

**Electrical Characteristics<sup>(5)</sup>**

$V_{IN} = 12\text{V}$ ,  $C_{IN} = 1.0\mu\text{F}$ ,  $C_{PSRR} = 0.1\mu\text{F}$ ,  $C_{OUT} = 10\mu\text{F}$ ,  $I_{OUT} = 100\mu\text{A}$ ,  $T_A = 25^{\circ}\text{C}$ , **bold** values indicate  $-40^{\circ}\text{C} \leq T_J \leq +125^{\circ}\text{C}$ , unless noted.

Parameter	Condition	Min.	Typ.	Max.	Units
<b>Power Supply Input</b>					
Input Voltage Range <sup>(6)</sup>		6		120	V
Quiescent Supply Current <sup>(7)</sup>	$I_{OUT} = 0$		6	<b>11</b>	$\mu\text{A}$
<b>Output Voltage</b>					
Output Voltage	Adjustable	1.27		5.5	V
	Fixed 3.3V	3.2	3.3	3.4	
		<b>3.13</b>	3.3	<b>3.47</b>	
	Fixed 5.0V	4.85	5.0	5.15	
<b>4.75</b>		5.0	<b>5.25</b>		
Output Voltage Accuracy	Variation from nominal $V_{OUT}$	-3		+3	%
		<b>-5</b>		<b>+5</b>	%
Load Regulation	$I_{OUT} = 100\mu\text{A}$ to 25mA	<b>-1.0</b>	0.2	<b>+1.0</b>	%
Line Regulation <sup>(8)</sup>	$V_{IN} = 10\text{V}$ to 120V	<b>-0.5</b>	0.04	<b>+0.5</b>	%/V
<b>Feedback Input (Adjustable)</b>					
FB Voltage		1.232	1.270	1.308	V
		<b>1.206</b>	1.270	<b>1.333</b>	
FB Current	$V_{FB} = 1.27\text{V}$		3.2		nA
<b>Current Limit</b>					
Current Limit	$V_{OUT} = 0\text{V}$	<b>30</b>	65	<b>130</b>	mA
<b>Ripple Rejection</b>					
Power Supply Rejection Ratio	$f = 20\text{kHz}$ to 2MHz		90		dB

## Electrical Characteristics<sup>(5)</sup> (Continued)

$V_{IN} = 12V$ ,  $C_{IN} = 1.0\mu F$ ,  $C_{PSRR} = 0.1\mu F$ ,  $C_{OUT} = 10\mu F$ ,  $I_{OUT} = 100\mu A$ ,  $T_A = 25^\circ C$ , **bold** values indicate  $-40^\circ C \leq T_J \leq +125^\circ C$ , unless noted.

Parameter	Condition	Min.	Typ.	Max.	Units
<b>Power Dropout Voltage</b>					
Dropout Voltage	$I_{OUT} = 25mA$		<b>2</b>	<b>3</b>	V
Thermal-Shutdown Temperature	$T_J$ rising		157		$^\circ C$
Thermal-Shutdown Hysteresis			15		$^\circ C$

### Notes:

- Exceeding the absolute maximum rating may damage the device.
- The device is not guaranteed to function outside its operating rating.
- The maximum allowable power dissipation at any  $T_A$  (ambient temperature) is  $P_{D(max)} = (T_{J(max)} - T_A) / \theta_{JA}$ . Exceeding the maximum allowable power dissipation results in excessive die temperature, and causes the regulator to enter thermal shutdown.
- Devices are ESD sensitive; use proper handling precautions. Human body model, 1.5k $\Omega$  in series with 100pF.
- Specifications are for packaged products only.
- Assure that  $V_{IN} \geq (V_{OUT} + 3V)$  and  $V_{IN} \geq 6V$ .
- Quiescent current is specified for the adjustable option. Fixed output options will add approximately 1 $\mu A$  due to the internal feedback resistors.
- Line regulation is a percentage of  $V_{OUT}$ .

# Typical Characteristics

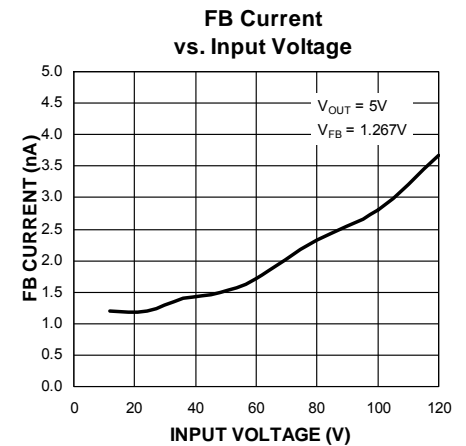
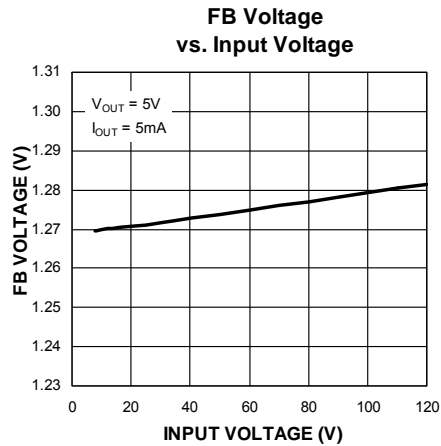
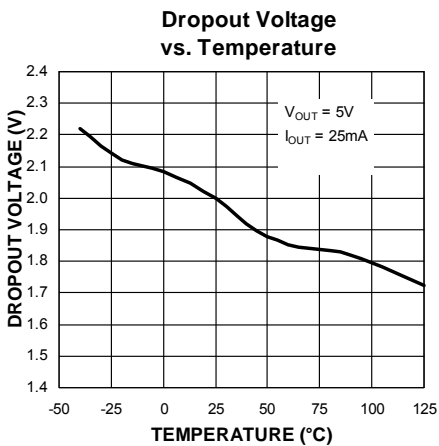
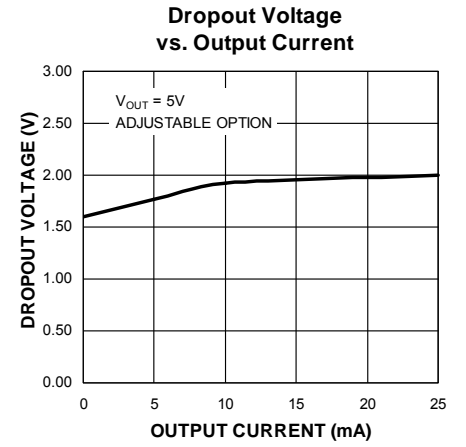
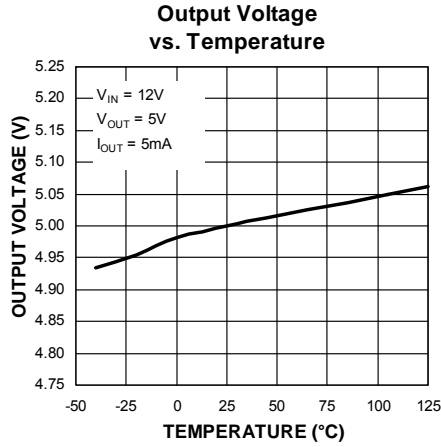
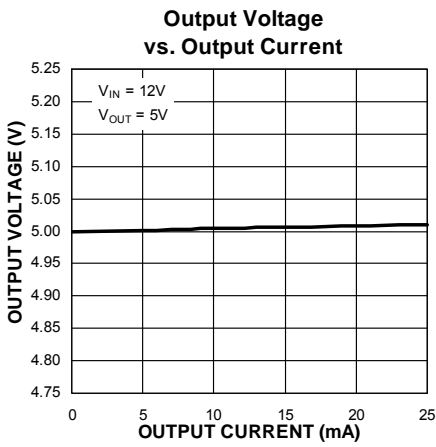
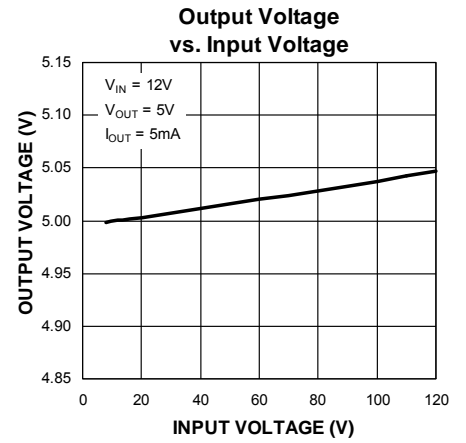
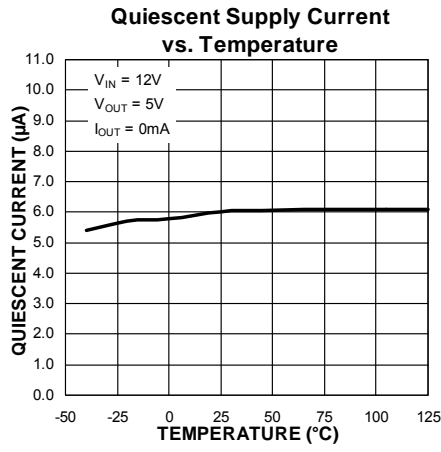
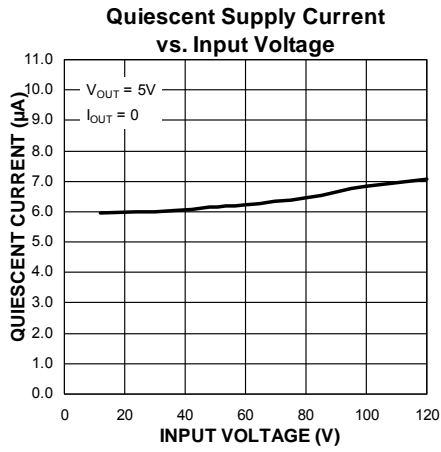

## Typical Characteristics (Continued)

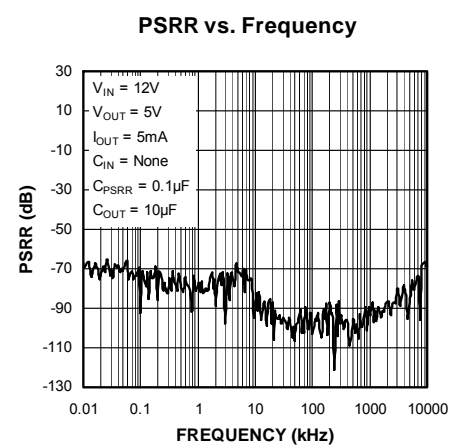
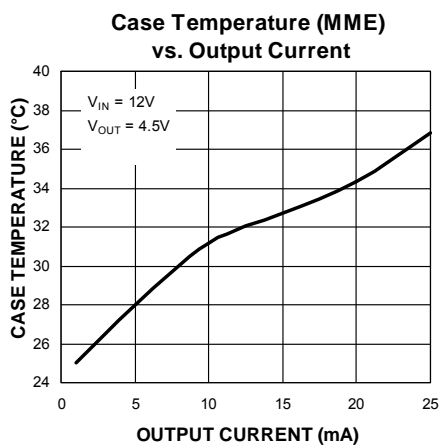
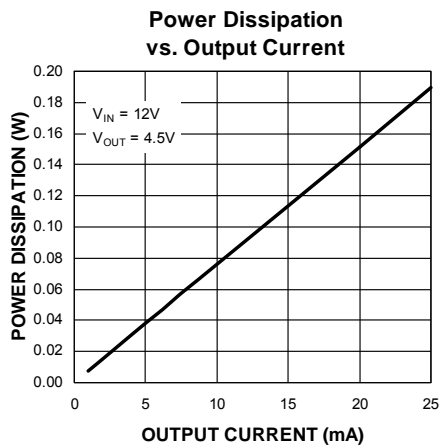
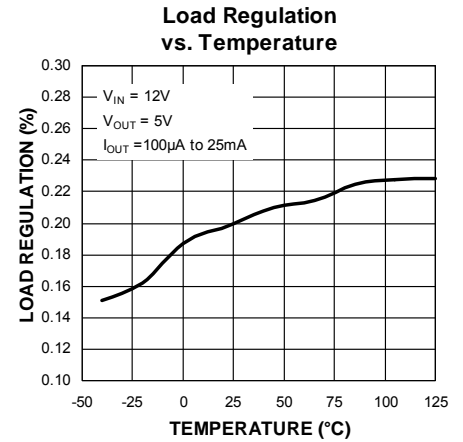
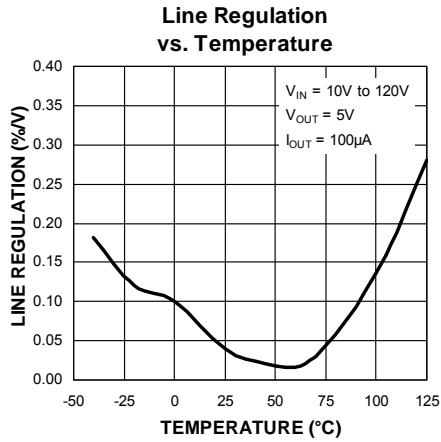
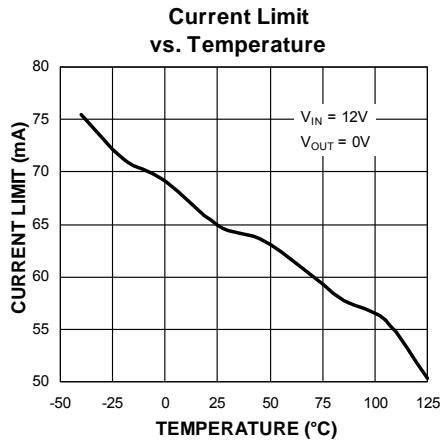
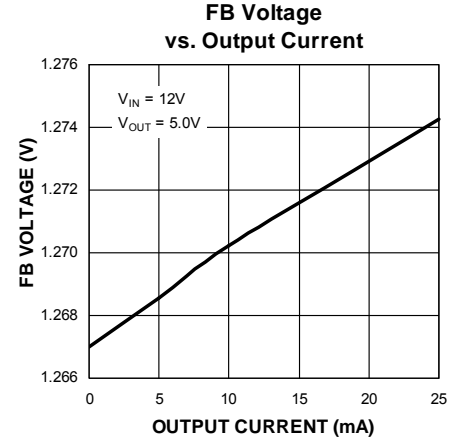
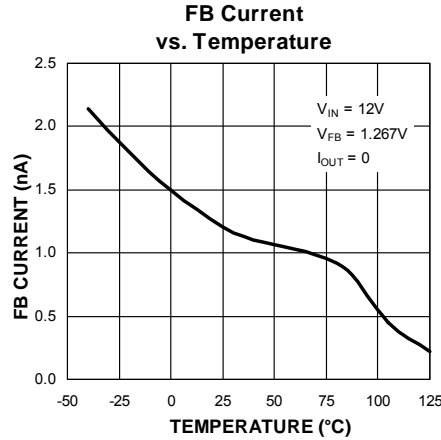
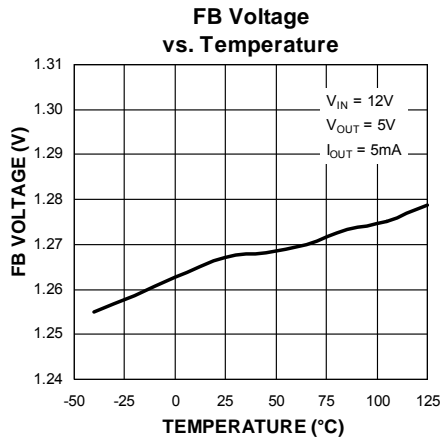

**Case Temperature\*:** The temperature measurement was taken at the hottest point on the MAQ5282 case mounted on a 2.25 square inch PCB at an ambient temperature of 25°C; see “Thermal Measurement” section. Actual results will depend upon the size of the PCB, ambient temperature and proximity to other heat emitting components.

### Functional Characteristics

**Soft Turn-On into Full Load**

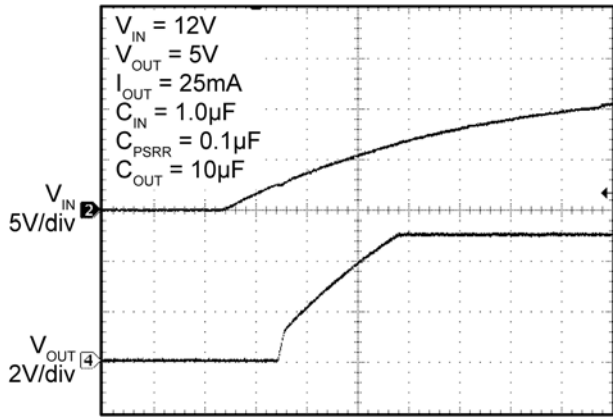

Time (4ms/div)

**Soft Turn-Off**

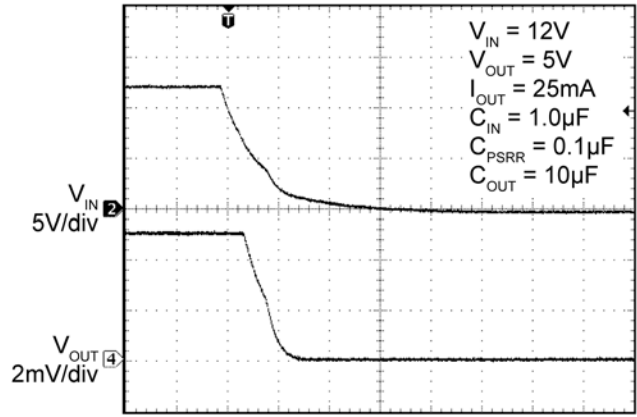

Time (200ms/div)

**Hot Plug**

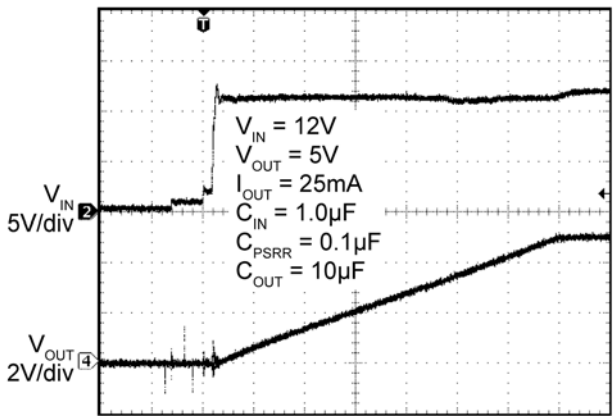

Time (100µs/div)

**Hot Un-Plug**

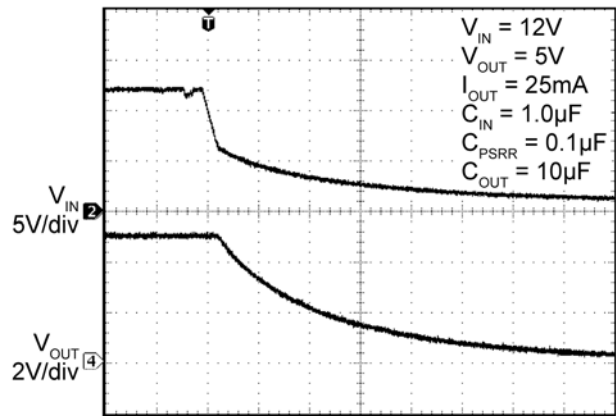

Time (4.0ms/div)

**Turn-On and Turn-Off**

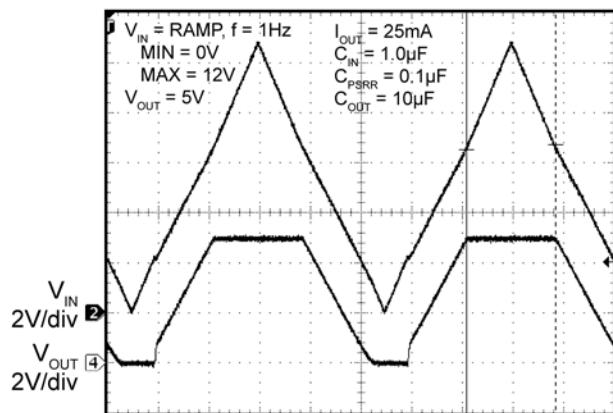

Time (200ms/div)

**Current Limit**

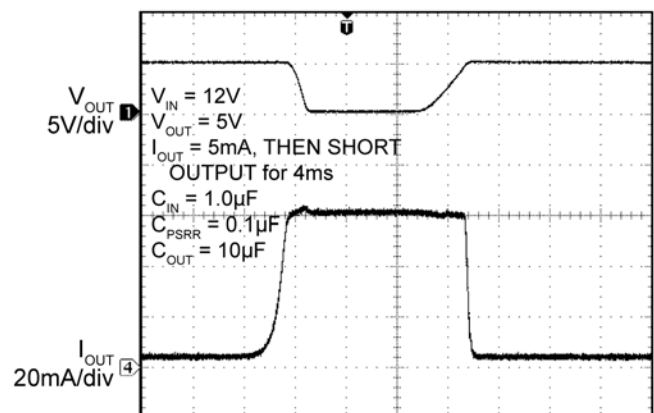

Time (1.0ms/div)

Functional Characteristics (Continued)

Thermal Shutdown, Short Circuit

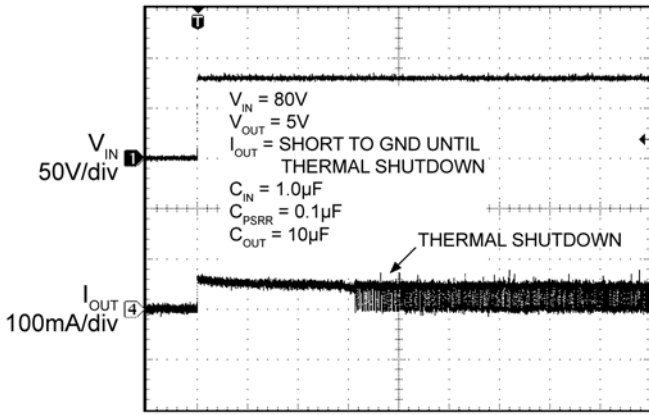

Time (100ms/div)

Turn-On into Short Circuit

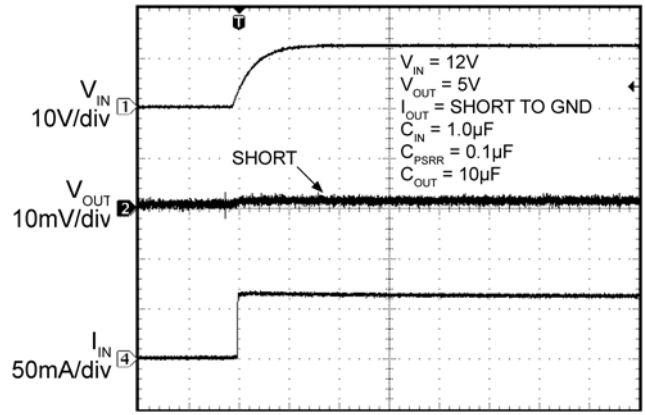

Time (40ms/div)

Short-Circuit Response

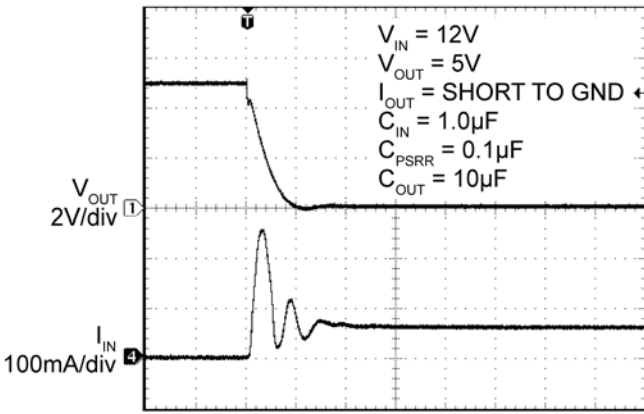

Time (4.0µs/div)

Short-Circuit Output Voltage Recovery

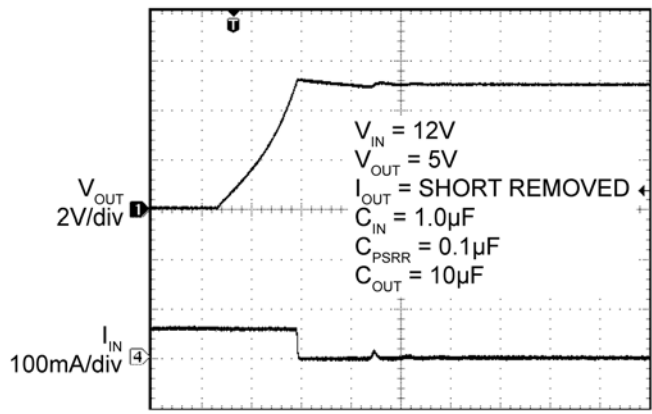

Time (400µs/div)

Load Transient Response

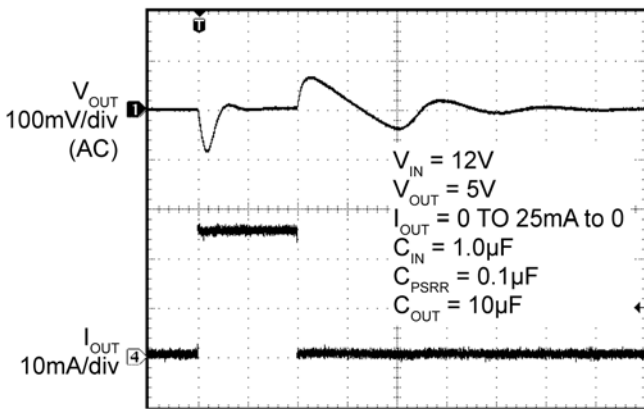

Time (100µs/div)

Line Transient Response

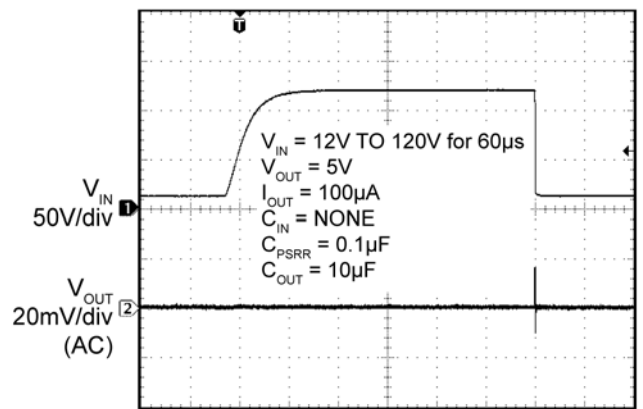

Time (10µs/div)



## Detailed Description

The MAQ5281 voltage regulator accepts a 6V to 120V input and has an ultra-low 6 $\mu$ A typical quiescent current while offering an excellent line transient response and PSRR. These features make it ideal for harsh, noisy environments. All options of the device offer 25mA of output current. The MAQ5281YMME offer an adjustable output voltage from 1.27V to 5.5V. The MAQ5281-3.3YMME offer fixed 3.3V outputs and the MAQ5281-5.0YMME offer fixed 5.0V outputs. The YMME packaged devices feature a heat slug to more effectively remove heat from the die.

## Applications Information

### Thermal Protection

The MAQ5281 has an internal thermal shutdown circuit to protect it from excessive heating of the die. When the junction temperature exceeds approximately +155°C, the output is disabled and the device begins to cool down. The device turns back on when the junction temperature cools by 15°C. This will result in a cycled output during continuous thermal-overload conditions.

### Current Limit

The MAQ5281 features output current-limit protection. The output sustains a continuous short circuit to GND without damage to the device, but thermal shutdown often results.

### Input Capacitor

Connect a 1 $\mu$ F capacitor from VIN to GND. Micrel recommends the C5750X7R2E105M, 1 $\mu$ F, 250V capacitor made by TDK. When using a different capacitor, assure that the voltage rating of the capacitor exceeds any potential transient.

### CPSRR Capacitor

Connect a 0.1 $\mu$ F capacitor from CPSRR to GND to maintain high power supply rejection. The voltage rating of the capacitor must be at least 14V.

### Output Capacitor

Connect a 10 $\mu$ F capacitor from VOUT to GND. Assure that the voltage rating of the capacitor exceeds the designed output voltage of the MAQ5281.

### Output Voltage Setting

For the MAQ5281YMME, V<sub>OUT</sub> is programmed from 1.27V to 5.5V using:

$$V_{OUT} = V_{REF} \times \left( \frac{R1}{R2} + 1 \right)$$

where V<sub>REF</sub> = 1.27V, and R1 and R2 are shown in the Typical Applications circuit.

### Thermal Measurements

It is always wise to measure an IC's case temperature to make sure that it is within operating limits, but it is easy to get erroneous results. The standard thermocouple that comes with many voltage meters uses a large wire gauge that behaves like a heat-sink, resulting in artificially low case temperature measurements. Use a thermocouple of 36-gauge wire or smaller, such as the Omega (5SC-TT-K-36-36), to minimize the heat-sinking effect. Also, apply thermal compound to maximize heat transfer between the IC and the thermocouple.

An infrared thermometer is a recommended alternative. The IR thermometer from Optris has a 1mm spot size, ideal for monitoring small surface mount packages. Also, the optional stand makes it easy to keep the beam on the IC for long periods of time.

## Functional Diagram

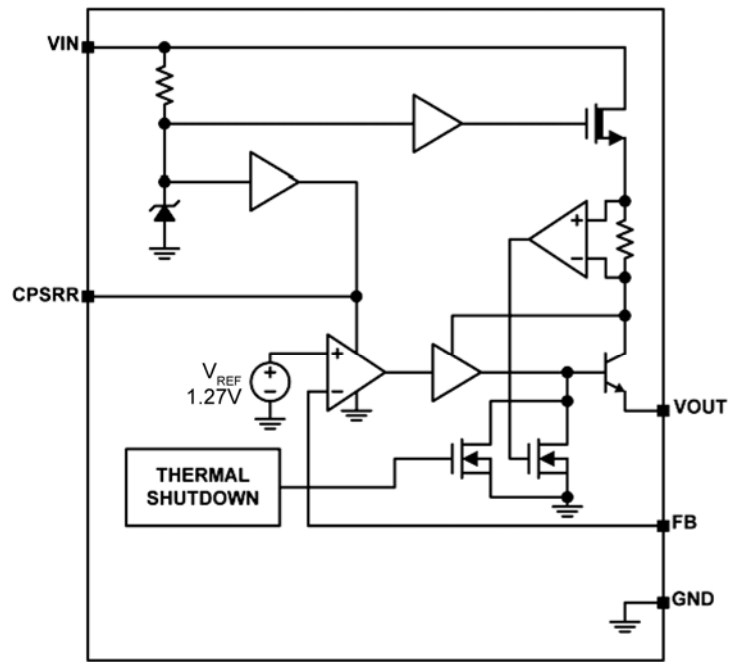

**MAQ5281 Adjustable Version**

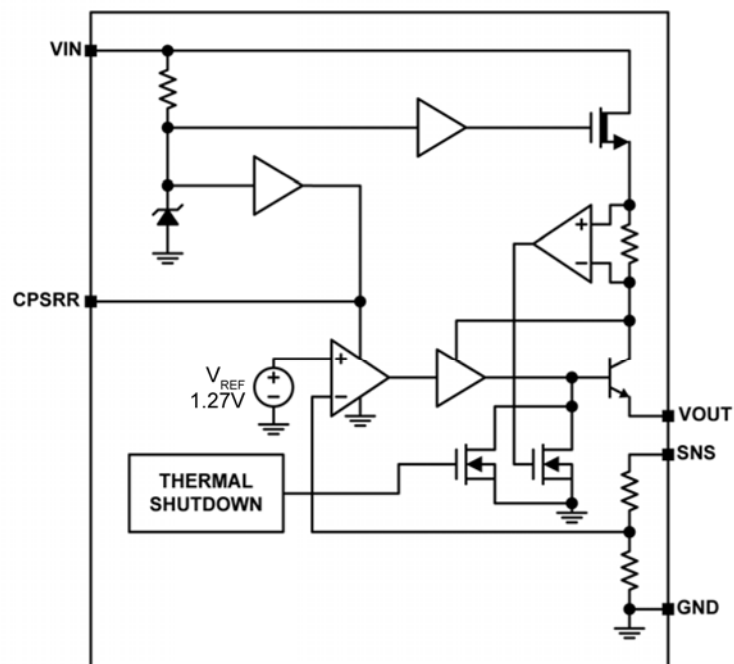

**MAQ5281 Fixed Version**

# MAQ5281 Evaluation Board Schematic

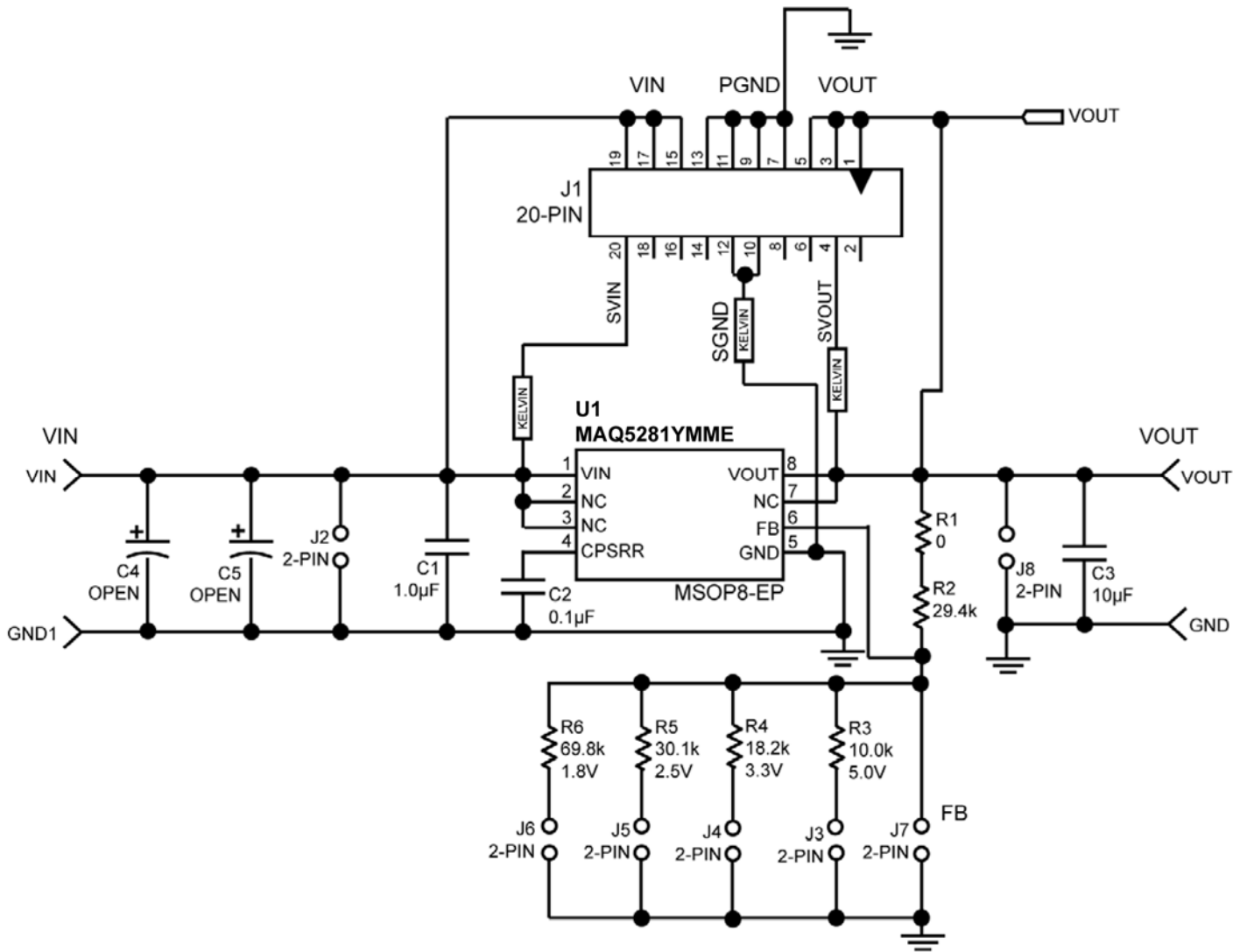

MAQ5281 Evaluation Board Schematic

**Bill of Materials**

Item	Part Number	Manufacturer	Description	Qty.
C1	C5750X7R2E105M	TDK <sup>(1)</sup>	1.0 $\mu$ F, 250V, 20%, X7R capacitor (2220)	1
C2	08053C104KAT2A	AVX <sup>(2)</sup>	0.1 $\mu$ F 25V 20%, X5R capacitor (0805)	1
C3	0805ZD106KAT2A	AVX	10 $\mu$ F, 10V, 20%, X5R, capacitor (0805)	1
C4, C5	OPEN			0
R1	CRCW06030000F	Vishay/Dale <sup>(3)</sup>	0 $\Omega$ , 1% resistor, 0603	1
R2	CRCW06032942F	Vishay/Dale	29.4k $\Omega$ , 1% resistor, 0603	1
R3	CRCW06031002F	Vishay/Dale	10.0k $\Omega$ , 1% resistor, 0603	1
R4	CRCW06031822F	Vishay/Dale	18.2k $\Omega$ , 1%, resistor, 0603	1
R5	CRCW06033012F	Vishay/Dale	30.1k $\Omega$ , 1% resistor chip, 0603	1
R6	CRCW06036982F	Vishay/Dale	69.8k $\Omega$ , 1%, resistor, 0603	1
U1	MAQ5281YMME	Micrel <sup>(4)</sup>	120V <sub>IN</sub> , 25mA, Ultra-Low I <sub>Q</sub> , High-PSRR Linear Regulator	1

**Notes:**

1. TDK: [www.tdk.com](http://www.tdk.com).
2. AVX.: [www.avx.com](http://www.avx.com).
3. Vishay Tel: [www.vishay.com](http://www.vishay.com).
4. Micrel, Inc.: [www.micrel.com](http://www.micrel.com).

# PCB Evaluation Board Layout

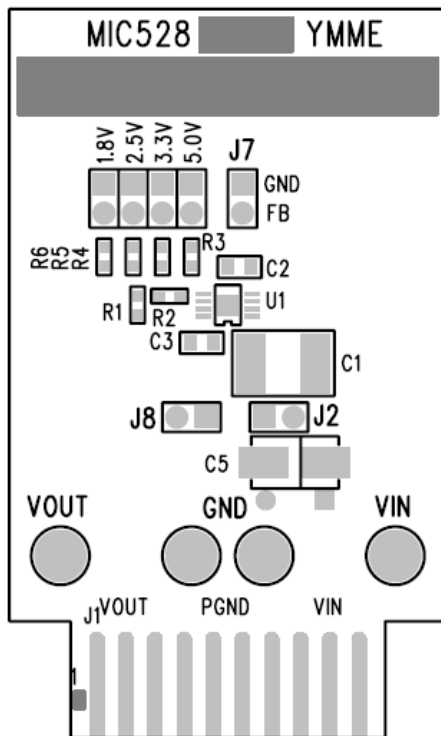

Top Layer Silk Screen

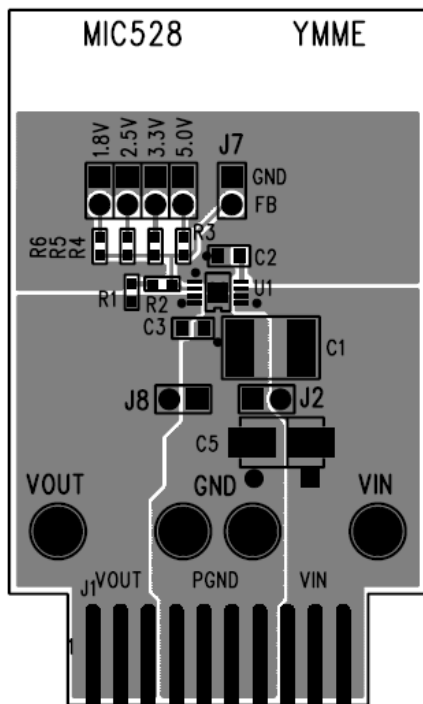

Top Layer Traces

### PCB Evaluation Board Layout (Continued)

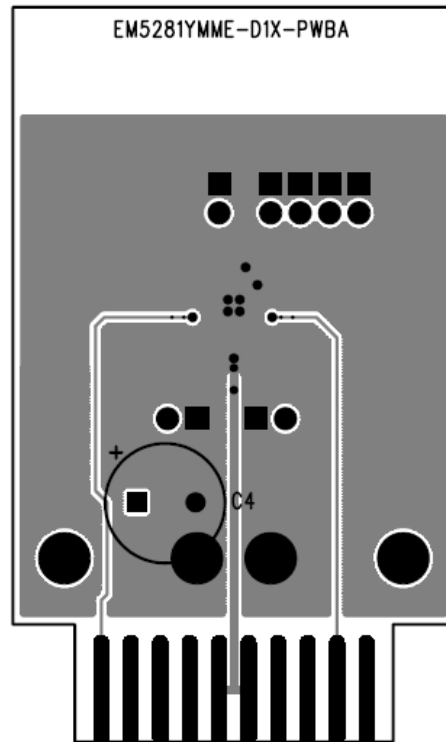

Bottom Layer Traces

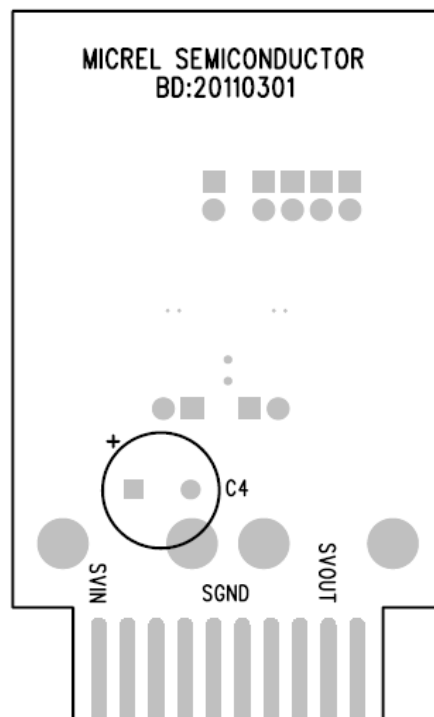

Bottom Layer Silk Screen

### PCB Evaluation Board Layout (Continued)

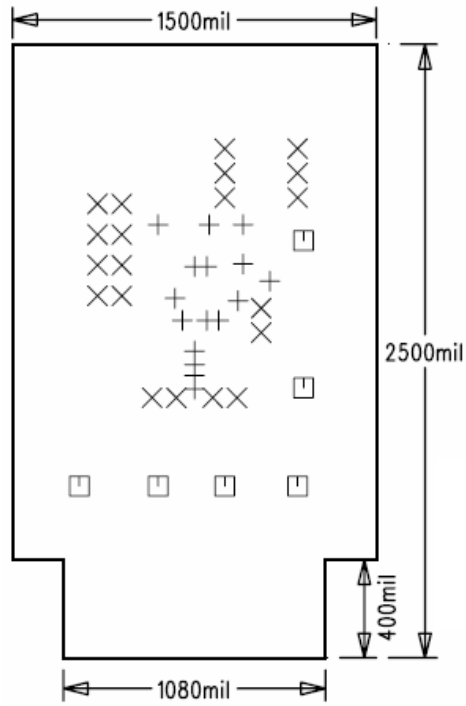

**EV Board Dimensions**

### Package Information

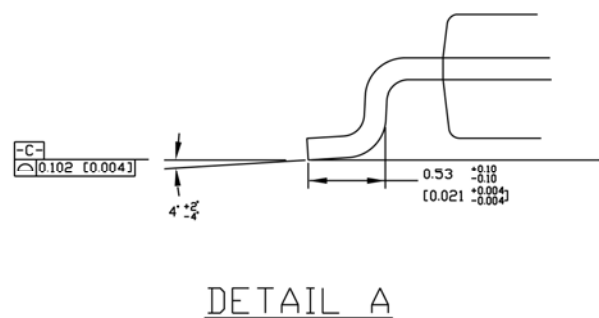
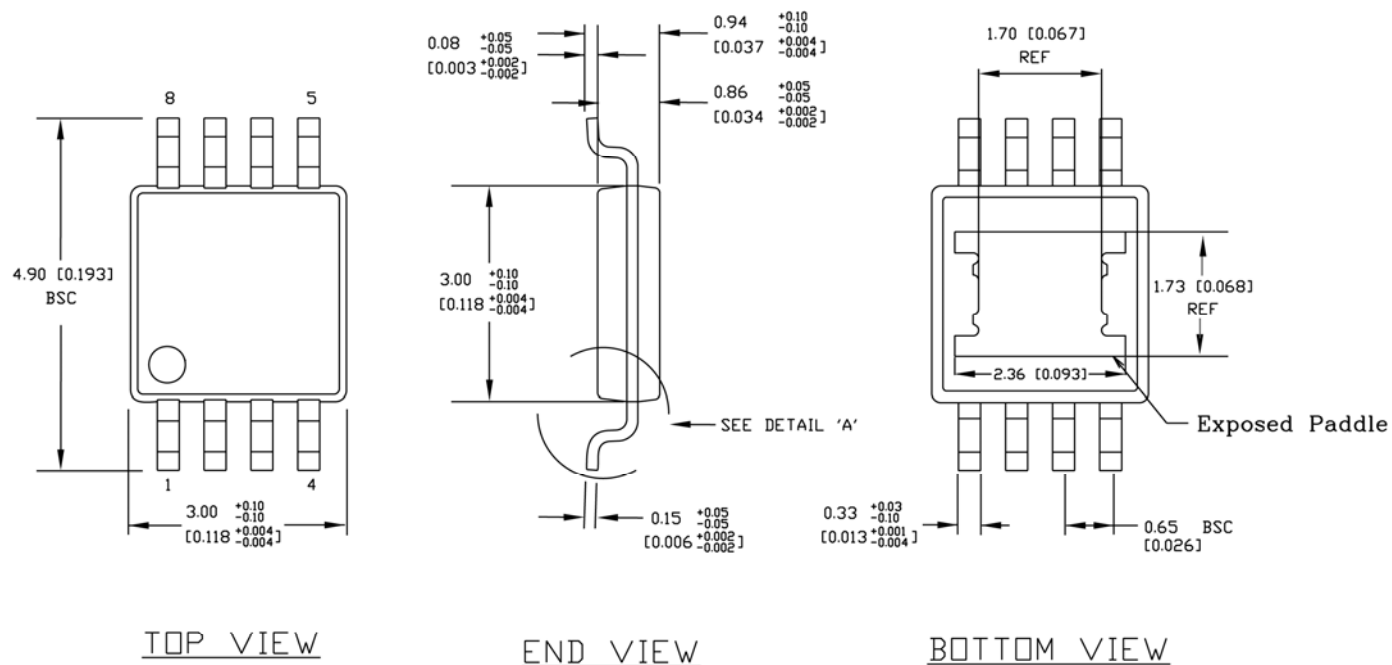

- NOTES:**
1. DIMENSIONS ARE IN MM [INCHES].
  2. CONTROLLING DIMENSION: MM
  3. DIMENSION DOES NOT INCLUDE MOLD FLASH OR PROTRUSIONS, EITHER OF WHICH SHALL NOT EXCEED 0.20 [0.008] PER SIDE.

### 8-Pin Exposed Pad (ePad) MSOP (MME)





---

**MICREL, INC. 2180 FORTUNE DRIVE SAN JOSE, CA 95131 USA**  
TEL +1 (408) 944-0800 FAX +1 (408) 474-1000 WEB <http://www.micrel.com>

Micrel makes no representations or warranties with respect to the accuracy or completeness of the information furnished in this data sheet. This information is not intended as a warranty and Micrel does not assume responsibility for its use. Micrel reserves the right to change circuitry, specifications and descriptions at any time without notice. No license, whether express, implied, arising by estoppel or otherwise, to any intellectual property rights is granted by this document. Except as provided in Micrel's terms and conditions of sale for such products, Micrel assumes no liability whatsoever, and Micrel disclaims any express or implied warranty relating to the sale and/or use of Micrel products including liability or warranties relating to fitness for a particular purpose, merchantability, or infringement of any patent, copyright or other intellectual property right.

Micrel Products are not designed or authorized for use as components in life support appliances, devices or systems where malfunction of a product can reasonably be expected to result in personal injury. Life support devices or systems are devices or systems that (a) are intended for surgical implant into the body or (b) support or sustain life, and whose failure to perform can be reasonably expected to result in a significant injury to the user. A Purchaser's use or sale of Micrel Products for use in life support appliances, devices or systems is a Purchaser's own risk and Purchaser agrees to fully indemnify Micrel for any damages resulting from such use or sale.

© 2012 Micrel, Incorporated.