

Diode Fast



RoHS
Compliant



Features:

- High efficiency, Low V_F
- High current capability
- High reliability
- High surge current capability
- Low power loss

Specifications:

Mechanical Data:

Cases	: Moulded plastic
Lead	: Pure tin plated, lead free, solderable per MIL-STD-202, Method 208 guaranteed
Polarity	: Colour band denotes cathode end
High temperature soldering guaranteed	: 260°C/10 seconds/0.375", (9.5mm) lead lengths at 5lbs., (2.3kg) tension
Weight	: 0.4g

Maximum Ratings and Electrical Characteristics:

Rating at 25°C ambient temperature unless otherwise specified.

Single phase, half wave, 60Hz, resistive or inductive load.

For capacitive load, derate current by 20%.

Type Number	Symbol	FR203	FR205	FR207	Units
Maximum Recurrent Peak Reverse Voltage	V_{RRM}	200	600	1,000	V
Maximum RMS Voltage	V_{RMS}	140	420	700	
Maximum DC Blocking Voltage	V_{DC}	200	600	1,000	
Maximum Average Forward Rectified Current 0.375" (9.5mm) Lead Length at $T_A = 55^\circ\text{C}$	$I_{(AV)}$	2			A
Peak Forward Surge Current, 8.3ms Single Half Sine-wave Superimposed on Rated Load (JEDEC method)	I_{FSM}	60			
Maximum Instantaneous Forward Voltage at 1A	V_F	1.2			V
Maximum DC Reverse Current at $T_A = 25^\circ\text{C}$ at Rated DC Blocking Voltage at $T_A = 125^\circ\text{C}$	I_R	5 150	10 400		μA μA

Diode Fast



Type Number	Symbol	FR203	FR205	FR207	Units
Maximum Reverse Recovery Time (Note 1)	T_{rr}	150	250	500	nS
Typical Junction Capacitance (Note 2)	C_j	30			pF
Typical Thermal Resistance	$R_{\theta JA}$ $R_{\theta JL}$ $R_{\theta JC}$	60 18 5			$^{\circ}C/W$
Operating Temperature Range	T_J	-65 to +150			$^{\circ}C$
Storage Temperature Range	T_{STG}				

Note: 1. Reverse Recovery Test Conditions: $I_F = 0.5A$, $I_R = 1A$, $I_{RR} = 0.25A$.

Note: 2. Measured at 1MHz and Applied Reverse Voltage of 4V DC.

Note: 3. Mount on Cu-Pad Size 10mm x 10mm on PCB.

Ratings and Characteristic Curves (FR203, FR205 and FR207)

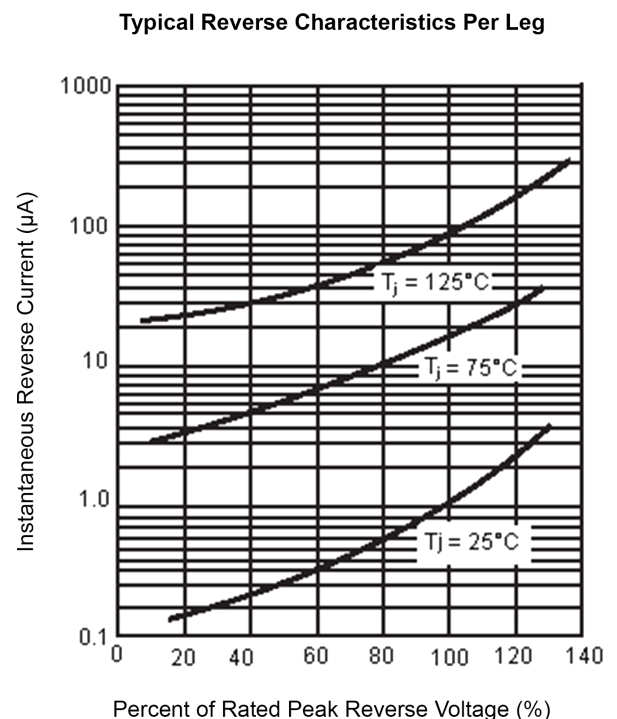
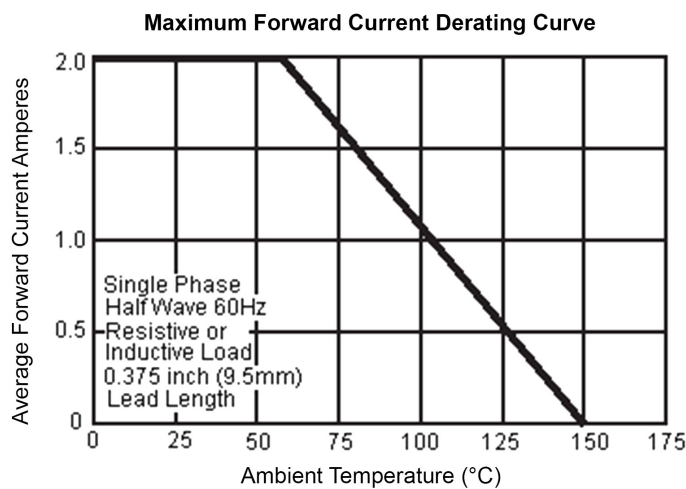

Maximum Non-Repetitive Forward Surge Current

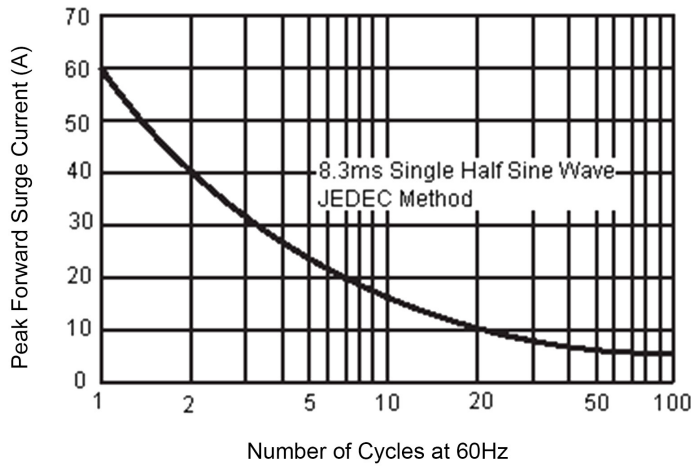

Typical Forward Characteristics

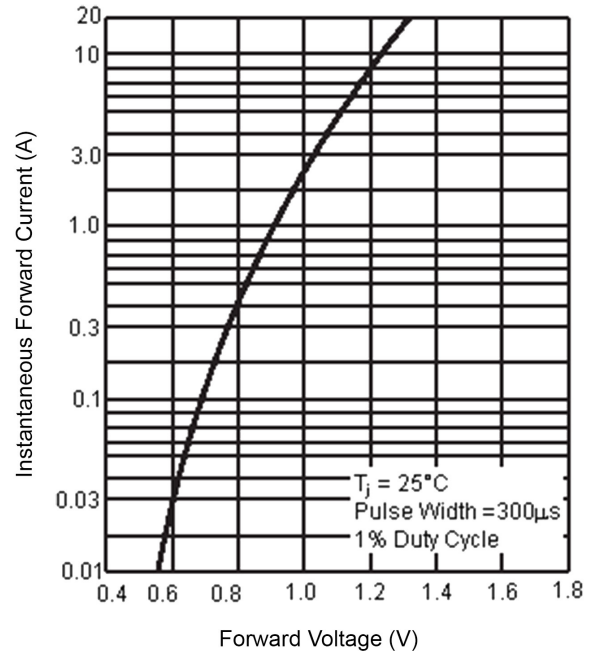

Typical Junction Capacitance

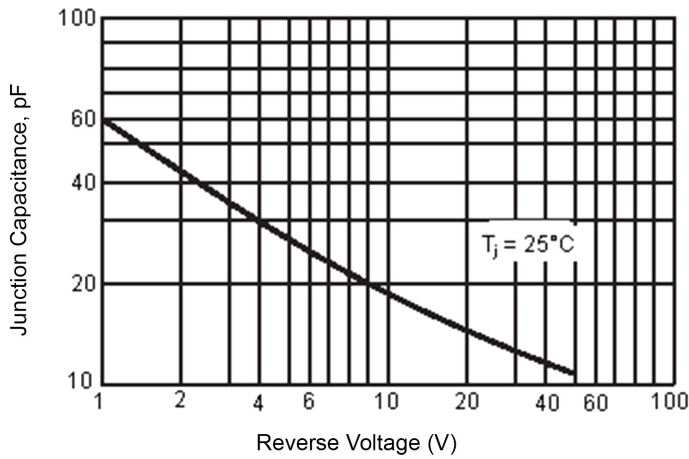

Diode Fast



Reverse Recovery Time Characteristic and Test Circuit Diagram

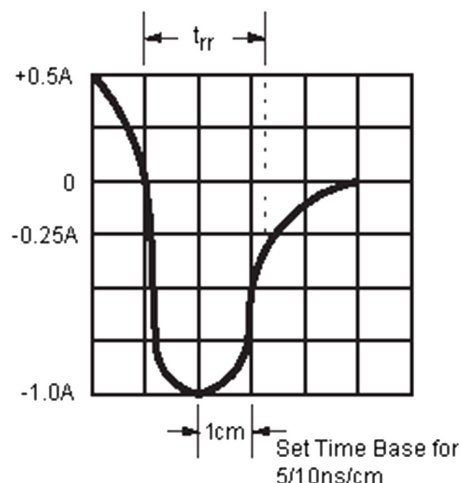
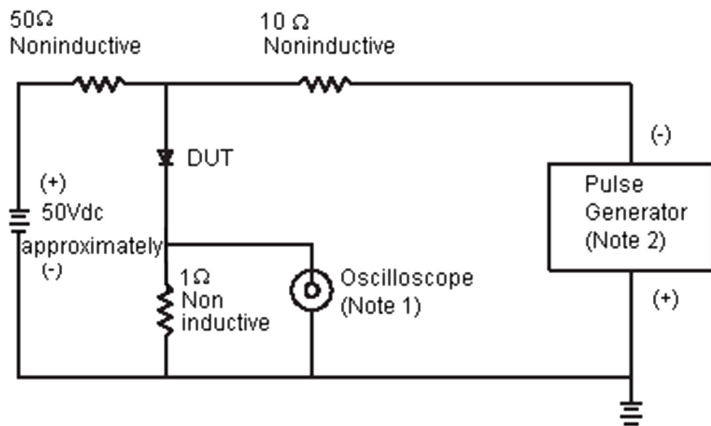

Note: 1. Rise Time = 7ns Maximum. Input Impedance = 1MΩ 22pf

Note: 2. Rise Time = 10ns Maximum Source Impedance = 50Ω

DO-15

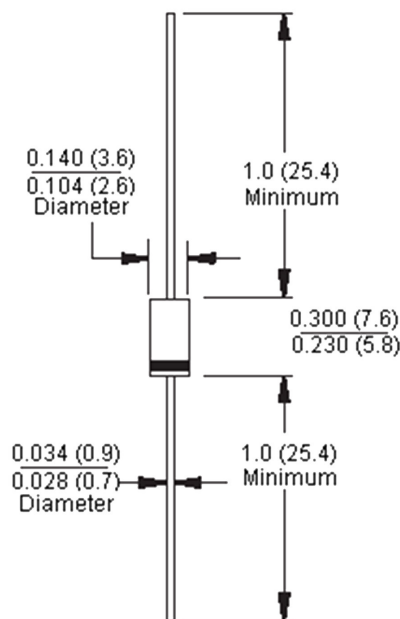

Dimensions : Inches (Millimetres)

Part Number Table

Description	Part Number
Diode, Fast, 2A, 200V	FR203
Diode, Fast, 2A, 600V	FR205
Diode, Fast, 2A, 1,000V	FR207

Important Notice : This data sheet and its contents (the "Information") belong to the members of the Premier Farnell group of companies (the "Group") or are licensed to it. No licence is granted for the use of it other than for information purposes in connection with the products to which it relates. No licence of any intellectual property rights is granted. The Information is subject to change without notice and replaces all data sheets previously supplied. The Information supplied is believed to be accurate but the Group assumes no responsibility for its accuracy or completeness, any error in or omission from it or for any use made of it. Users of this data sheet should check for themselves the Information and the suitability of the products for their purpose and not make any assumptions based on information included or omitted. Liability for loss or damage resulting from any reliance on the Information or use of it (including liability resulting from negligence or where the Group was aware of the possibility of such loss or damage arising) is excluded. This will not operate to limit or restrict the Group's liability for death or personal injury resulting from its negligence. Multicomp is the registered trademark of the Group. © Premier Farnell plc 2012.

