

Schottky Barrier Diode

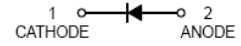

SOD-123

Features:

- Extremely Low V_f
- Low Stored Charge, Majority Carrier Conduction
- Low Power Loss / High Efficient

Applications:

- For Use in Low Voltage, High Frequency Inverters
- Free Wheeling and Polarity Protection Applications

Maximum Ratings:

Ratings at 25°C unless otherwise specified.

Parameter	Symbol	Value	Unit
Non-repetitive peak reverse voltage	V_{RSM}	48	V
Peak repetitive reverse voltage Working peak reverse voltage DC reverse voltage	V_{RRM} V_{RWM} V_R	40	V
RMS reverse voltage	$V_{R(RMS)}$	28	V
Average rectified output current	I_o	1	A
Peak forward surge current at =8.3ms	I_{FSM}	25	A
Power dissipation	P_d	250	mW
Thermal resistance junction to ambient air	$R_{\theta JA}$	80	°C/W
Storage temperature	T_j, T_{STG}	-65 to +125	°C



Electrical Characteristics:

Ratings at 25°C unless otherwise specified

Parameter	Symbol	Min.	Max.	Unit	Test Condition
Reverse breakdown voltage	$V_{(BR)}$	40	-	V	$I_R=1mA$
Forward voltage	V_F	-	0.6 0.9	V	$I_F=1A$ $I_F=3A$
Reverse voltage leakage current	I_R	-	1	mA	$V_R=40V$
Diode capacitance	C_D	-	120	pF	$V_R=4V, f=1MHz$

Typical Characteristics:

$T_A = 25^\circ C$ unless otherwise specified

Fig. 1 - Forward Current Derating Curve

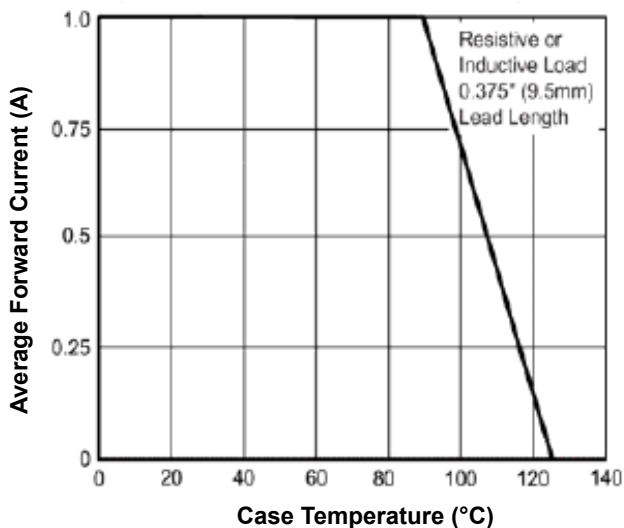

Fig. 2 - Maximum Non-Repetitive Peak Forward Surge Current

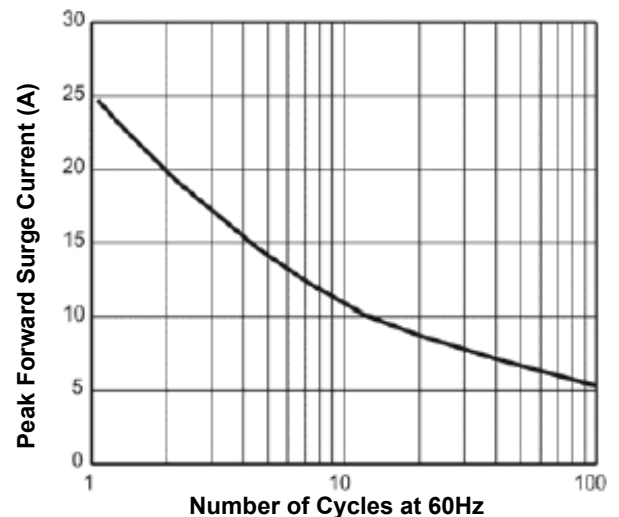

Fig. 3 - Typical Instantaneous Forward Characteristics

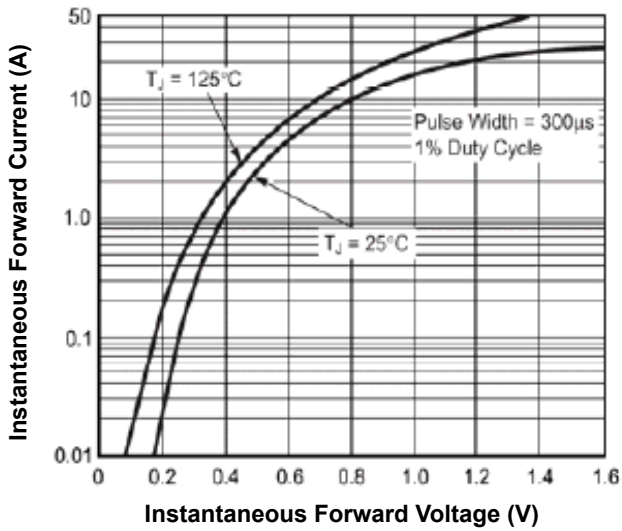

Fig. 4 - Typical Reverse Characteristics

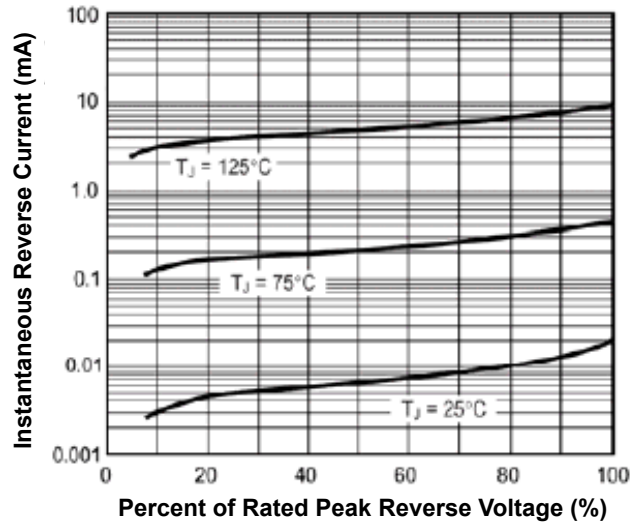

Fig. 5 - Typical Junction Capacitance

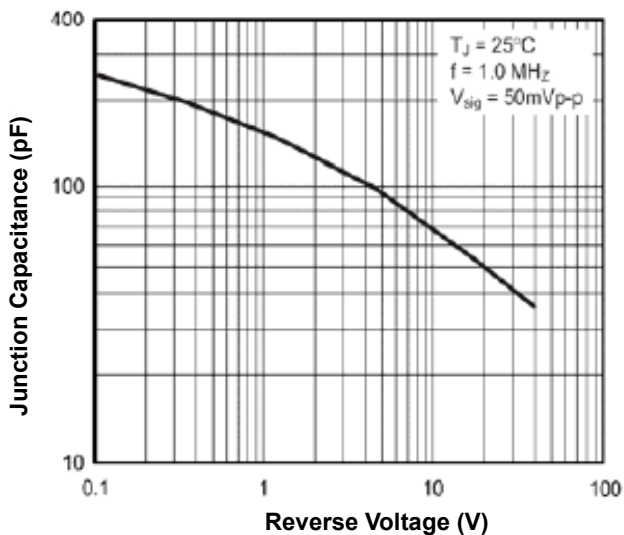
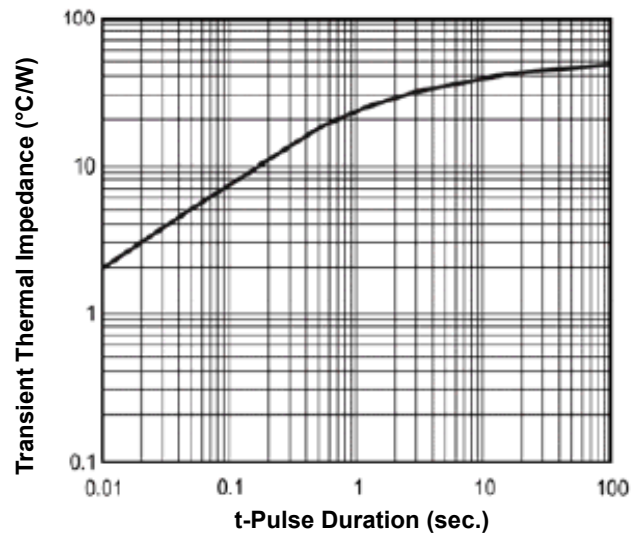

Fig. 6 - Typical Transient Thermal Impedance



Schottky Barrier Diode



Package Outline:

Plastic surface mounted package

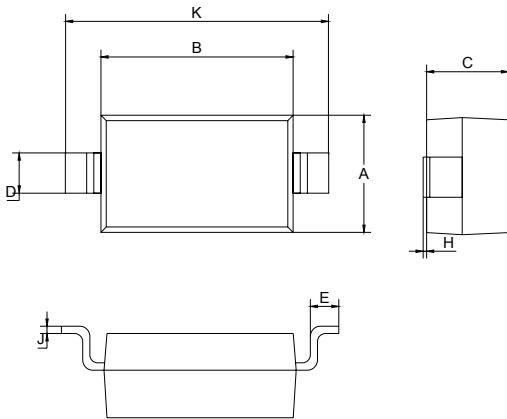

SOD-123		
Dim.	Min.	Max.
A	1.4	1.8
B	2.55	2.85
C	1.15 Typ.	
D	0.5	0.6
E	0.3	0.4
H	0.02	0.1
J	0.1 Typ.	
K	3.55	3.85

Dimensions : Millimetres

Soldering Footprint:

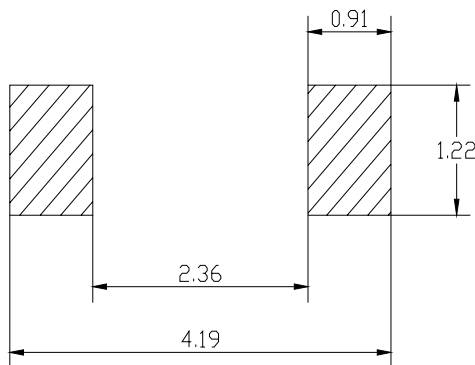

Dimensions : Millimetres

Package Information:

Device	Package	Shipping
1N5819HW-7-F	SOD-123	3,000 / Tape & Reel

Part Number Table

Description	Part Number
Schottky Barrier Diode	1N5819HW-7-F

Important Notice : This data sheet and its contents (the "Information") belong to the members of the Premier Farnell group of companies (the "Group") or are licensed to it. No licence is granted for the use of it other than for information purposes in connection with the products to which it relates. No licence of any intellectual property rights is granted. The Information is subject to change without notice and replaces all data sheets previously supplied. The Information supplied is believed to be accurate but the Group assumes no responsibility for its accuracy or completeness, any error in or omission from it or for any use made of it. Users of this data sheet should check for themselves the Information and the suitability of the products for their purpose and not make any assumptions based on information included or omitted. Liability for loss or damage resulting from any reliance on the Information or use of it (including liability resulting from negligence or where the Group was aware of the possibility of such loss or damage arising) is excluded. This will not operate to limit or restrict the Group's liability for death or personal injury resulting from its negligence. Multicomp is the registered trademark of the Group. © Premier Farnell plc 2012.

