

Power Choke Coil

Series: **PCC-M0630L (MC)**
PCC-M0630M (MC)

High power, Low loss , Compact size. Rust proof structure

Industrial Property : patents 21 (pending)



■ Features

- Downsize circuit space due to small and low profile package size
- Excellent DC bias performance and high reliability under high humidity
- Reduce number of components by high power and low loss
- Realize excellent performance by capability to high frequency range
- Low buzz noise
- RoHS compliant

■ Recommended Applications

- Servers, Routers, DC-DC converters for driving CPUs
- Laptop and desktop PC power supply
- Power supply modules

■ Standard Packing Quantity

- 1000 pcs./Reel

■ Explanation of Part Numbers

- PCC-M0630L series

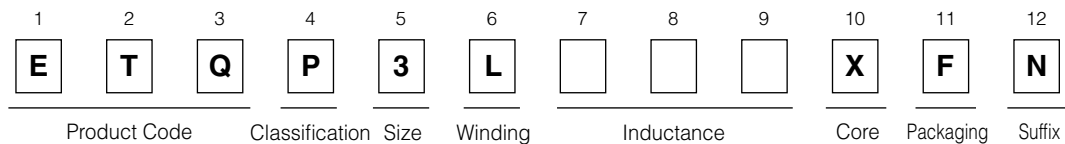

- PCC-M0630M series

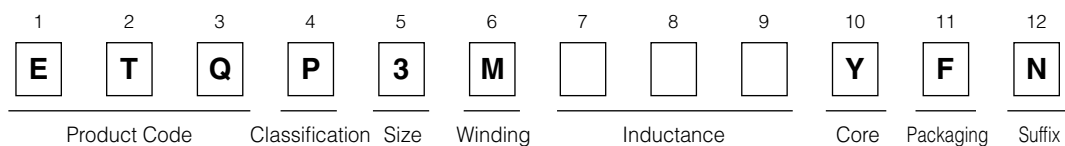

■ Standard Parts

Part No.	Inductance *1				Rated current (A) *2	DC resistance		Series
	L0		L1			Center (mΩ)	Tolerance (%)	
	(μH)	Tolerance (%)	(μH)	Measurement current (A)				
ETQP3LR33XFN	0.33	±20	0.28	17	17	2.0	±10	PCC-M0630L
ETQP3MR68YFN	0.68	±20	0.59	7.4	7.4	6.3	±10	PCC-M0630M
ETQP3M1R0YFN	1.00	±20	0.88	6.6	6.6	7.9	±10	PCC-M0630M
ETQP3M1R5YFN	1.50	±20	1.36	5.6	5.6	11.0	±10	PCC-M0630M

(*1) Inductance is measured at 100 kHz

(*2) Rated current defines actual value of DC current, when temperature rise of coil becomes 40 K.

Design and specifications are each subject to change without notice. Ask factory for the current technical specifications before purchase and/or use. Should a safety concern arise regarding this product, please be sure to contact us immediately.

■ Performance Characteristics (Reference)

● PCC-M0630L (MC)

● Inductance vs DC Current

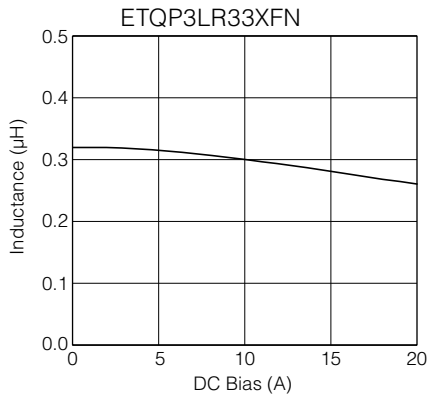

● Case Temperature vs DC Current

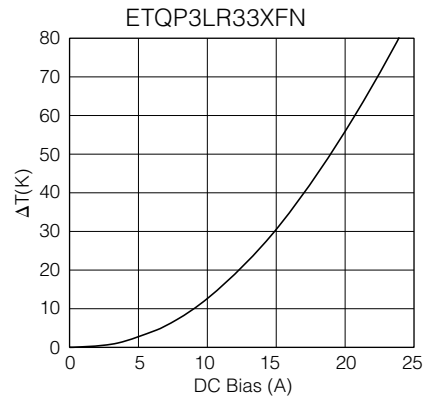

● PCC-M0630M (MC)

● Inductance vs DC Current

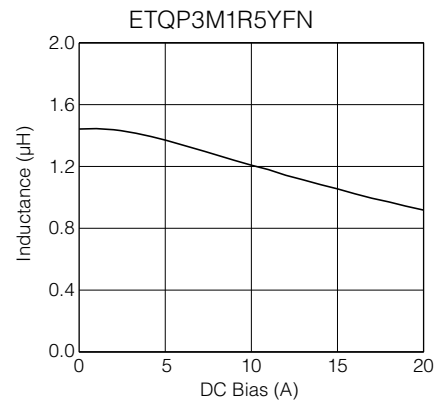
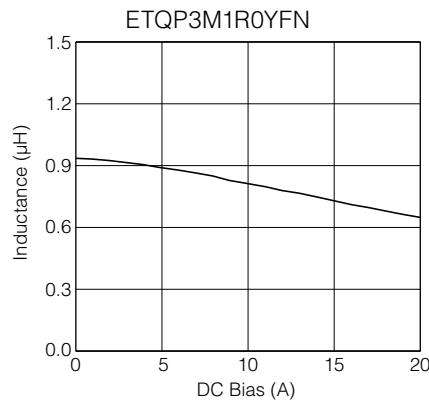
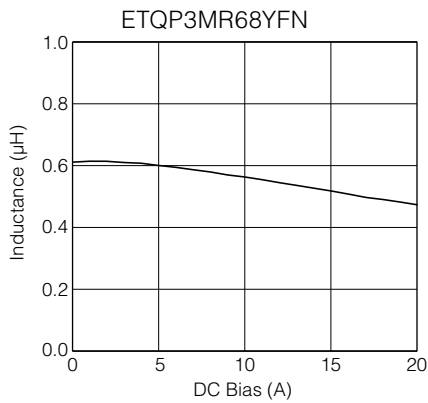

● Case Temperature vs DC Current*

PWB condition A : FR4, single layer PWB, t=1.6mm *our specification
 PWB condition B : FR4, four layer PWB, t=1.6mm

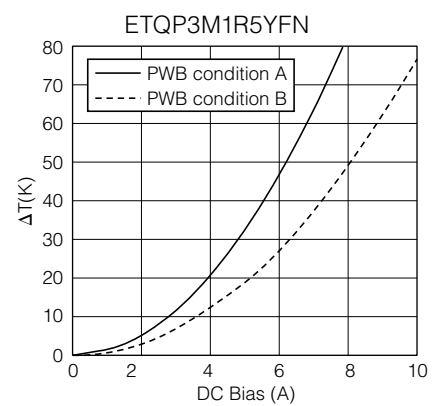
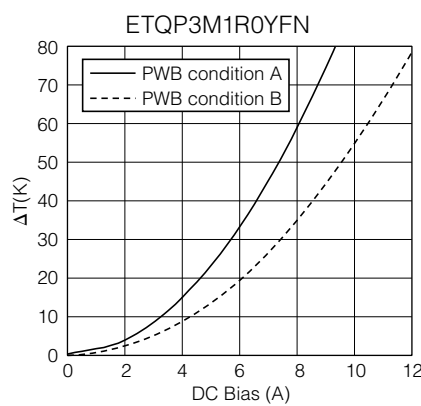
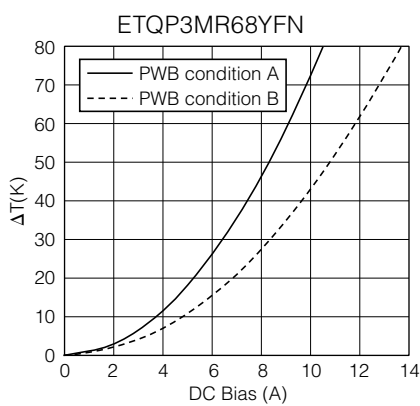

* Our temperature rise is specified with measurement of single layer PWB(condition A). Please refer to temperature rise curve V.S. current for the rated current (ΔT=15K) and Reference value (ΔT=40K). and when four layer PWB (condition B) is used, temperature rise is different from single layer PWB(conditionA). Even we specify the rated current at our condition, the actual temperature rise of PCC may have different result due to thermal dissipation condition. We recommend customers to measure PCC temperature rise at application to confirm it.

■ Dimensions in mm (not to scale)

PCC-M0630L (MC)
(ETQP3LR33XFN)

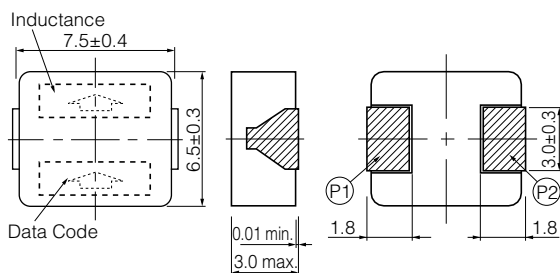

PCC-M0630M (MC)
(ETQP3M***YFN)

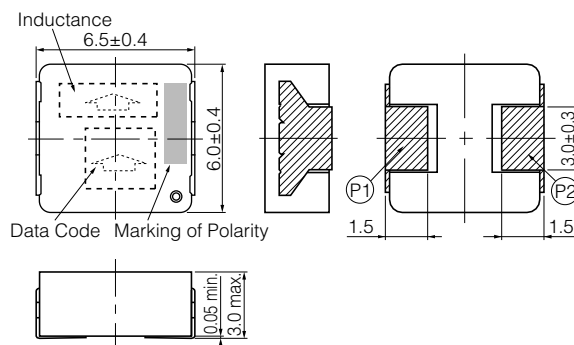

■ Connection

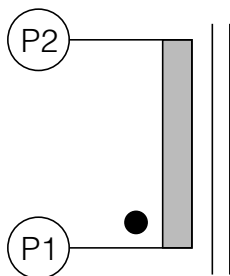

■ Recommended Land Pattern in mm (not to scale)

PCC-M0630L (MC)
(ETQP3LR33XFN)

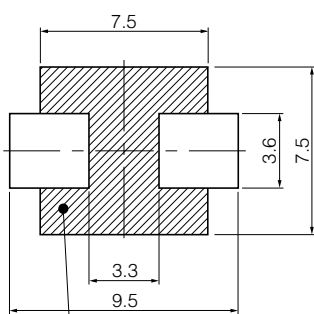

Not to contact the PWB.

PCC-M0630M (MC)
(ETQP3M***YFN)

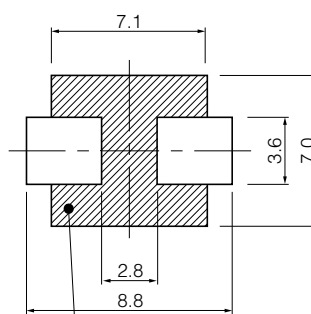

Not to contact the PWB.

■ Packaging Methods, Soldering Conditions and Safety Precautions
(High reliability use : PCC-M0630M, Consumer use : PCC-M0630L)
Please see Data Files