

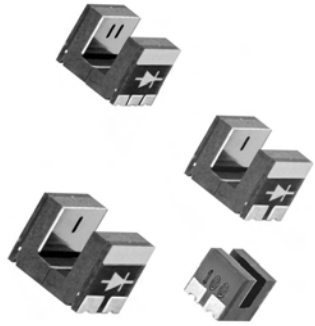



Photomicrosensor-Transmissive – EE-SX1107/1108/1109/1131

- Surface mount design, tape and reel packaging facilitate automated PCB.
- Compact size makes these sensors ideal for use in applications with restricted space.
- High-resolution sensing with phototransistor output.
- Dual channel model that is ideal for encoder applications (EE-SX1131).



Ordering Information

Appearance	Sensing Method	Slot Width	Slot Depth	Sensing Object	Weight	Part No.
	Transmissive	1 mm	2 mm	Opaque 0.15 x 0.6 mm.	0.05 g	EE-SX1107
		2 mm	2.8 mm	Opaque 0.3 x 1.0 mm.	0.1 g	EE-SX1108
		3 mm	3.5 mm	Opaque 0.5 x 1.0 mm.	0.1 g	EE-SX1109
	Dual channel transmissive	2 mm	2.8 mm	Opaque 0.3 x 1.0 mm.	0.1 g	EE-SX1131

Specifications

■ Absolute Maximum Ratings (Ta = 25°C)

Item		Symbol	Rated value
Emitter	Forward current	I_F	25 mA (see note 1)
	Pulse forward current	I_{FP}	100 mA (see note 2)
	Reverse Voltage	V_R	5 V
Detector	Collector-Emitter voltage	V_{CEO}	20 V
	Emitter-Collector voltage	V_{ECO}	5 V
	Collector current	I_C	20 mA
	Collector dissipation	P_C	75 mW (see note 1)
Ambient temperature	Operating	T_{opr}	-30°C to 85°C
	Storage	T_{stg}	-40°C to 90°C
	Reflow soldering	T_{sol}	240°C (see note 3)
	Manual soldering	T_{sol}	300°C (see note 3)

Note: 1. Refer to the temperature rating chart if the ambient temperature exceeds 25°C.

2. Duty: 1/100; Pulse width: 0.1 ms.

3. Complete soldering within 10 seconds for reflow soldering and within 3 seconds for manual soldering.

■ Electrical and Optical Characteristics (Ta = 25°C)

Item		Symbol	Value	Condition
Emitter	Forward voltage	V_F	1.1 V typ., 1.3 V max.	$I_F = 5 \text{ mA}$
	Reverse current	I_R	10 μA max.	$V_R = 5 \text{ V}$
	Peak emission wavelength	λ_p	940 nm typ.	$I_F = 20 \text{ mA}$
Detector	Light current	I_L	50 μA min., 150 μA typ., 500 μA max.	$I_F = 5 \text{ mA}$, $V_{CE} = 5 \text{ V}$
	Dark current	I_D	100 nA max.	$V_{CE} = 10 \text{ V}$, $0 \ell x$
	Leakage current	I_{LEAK}	–	–
	Collector-Emitter saturated voltage	$V_{CE}(\text{sat})$	0.1 V typ., 0.4 V max.	$I_F = 20 \text{ mA}$, $I_L = 50 \mu\text{A}$
	Peak spectral sensitivity wavelength	λ_p	900 nm typ.	–
Rising time		t_r	10 μs typ.	$V_{CC} = 5 \text{ V}$, $R_L = 1 \text{ k}\Omega$, $I_L = 100 \mu\text{A}$
Falling time		t_f	10 μs typ.	$V_{CC} = 5 \text{ V}$, $R_L = 1 \text{ k}\Omega$, $I_L = 100 \mu\text{A}$

Note: The following figures show the rising time (t_r) and falling time (t_f).1

■ Response Time Measurement Circuit

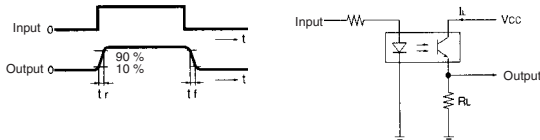

■ Dimensions

Note: All units are in millimetres unless stated.

EE-SX1107

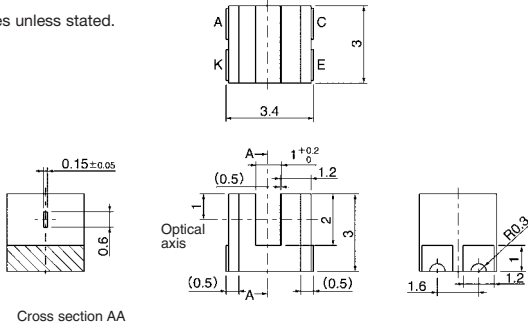

Cross section AA

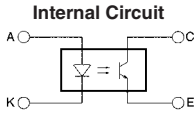

Recommended Soldering Pattern

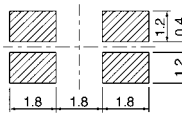

EE-SX1108

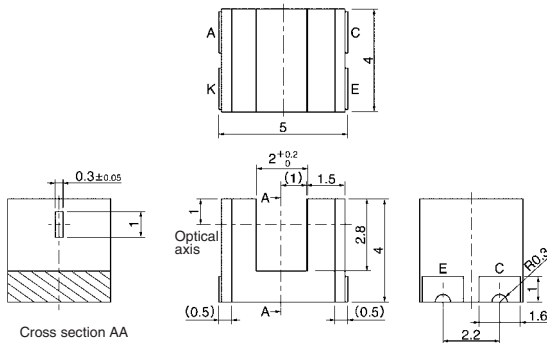

Cross section AA

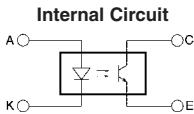

Recommended Soldering Pattern

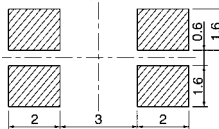

Unless otherwise stated the tolerances are ± 0.15 mm.

■ Dimensions

Note: All units are in millimetres unless stated.

EE-SX1109

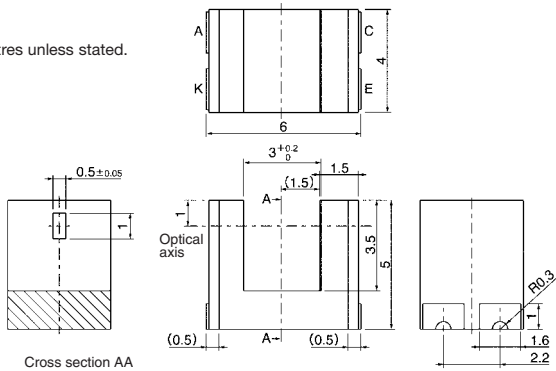

Cross section AA

Internal Circuit

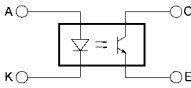

Recommended Soldering Pattern

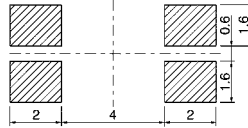

EE-SX1131

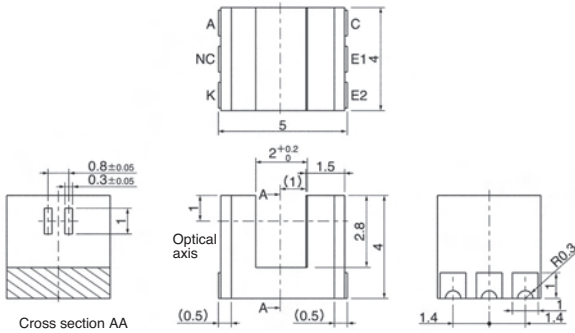

Cross section AA

Internal Circuit

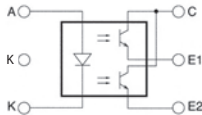

Recommended Soldering Pattern

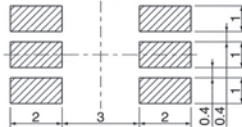

Terminal No.	Name
A	Anode
K	Cathode
C	Collector
E1	Emitter 1
E2	Emitter 2

Unless otherwise stated the tolerances are ± 0.15 mm.

■ Engineering Data

EE-SX1107/1108/1109/1131
Forward Current vs. Collector
Dissipation Temperature Rating

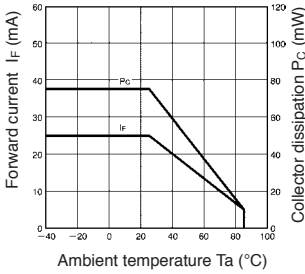

EE-SX1107/1108/1109/1131
Forward Current vs. Forward
Voltage Characteristics (Typical)

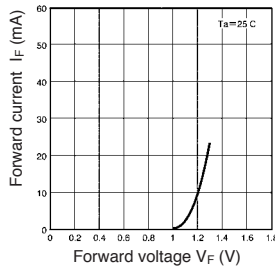

EE-SX1107
Light Current vs. Forward Current
Characteristics (Typical)

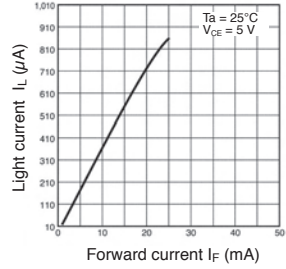

EE-SX1108/1131
Light Current vs. Forward Current
Characteristics (Typical)

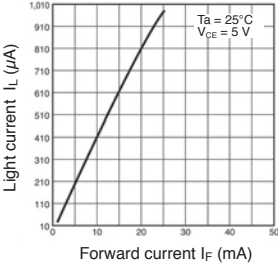

EE-SX1109
Light Current vs. Forward Current
Characteristics (Typical)

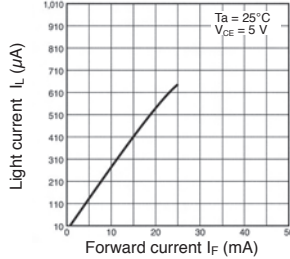

EE-SX1107
Light Current vs. Collector-Emitter
Voltage Characteristics (Typical)

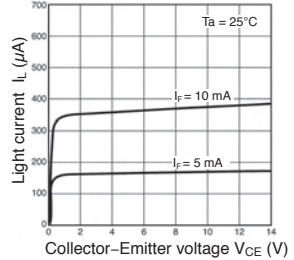

EE-SX1108/1131
Light Current vs. Collector-Emitter
Voltage Characteristics (Typical)

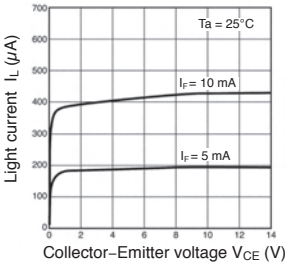

EE-SX1109
Light Current vs. Collector-Emitter
Voltage Characteristics (Typical)

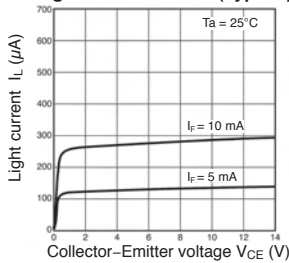

EE-SX1107/1108/1109/1131
Relative Light Current vs. Ambient
Temperature Characteristics (Typical)

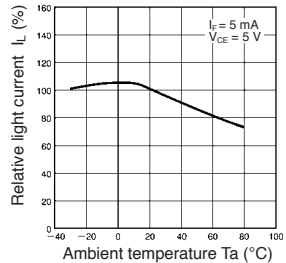

■ Engineering Data

EE-SX1107/1108/1109/1131
Dark Current vs. Ambient Temperature Characteristics (Typical)

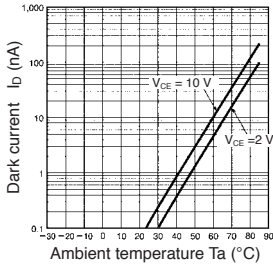

EE-SX1107/1108/1109/1131
Response Time vs. Load Resistance Characteristics (Typical)

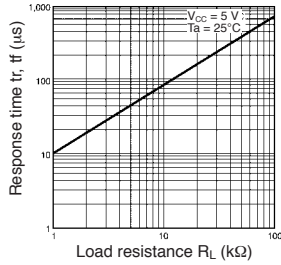

EE-SX1107
Sensing Position Characteristics (Typical)

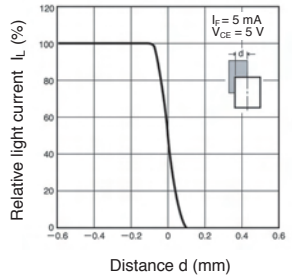

EE-SX1108
Sensing Position Characteristics (Typical)

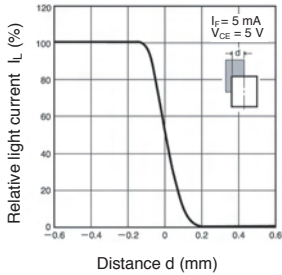

EE-SX1109
Sensing Position Characteristics (Typical)

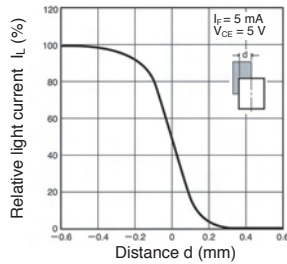

EE-SX1131
Sensing Position Characteristics (Typical)

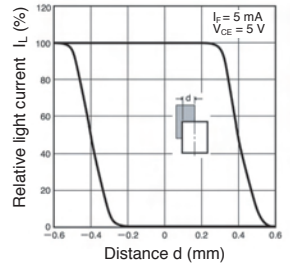

EE-SX1107/1108/1109/1131
Sensing Position Characteristics (Typical)

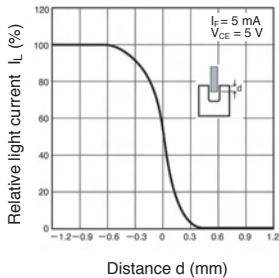

■ Tape and Reel – EE-SX1107, EE-SX1108, EE-SX1109 & EE-SX1131

Unit: mm (inch).

Reel

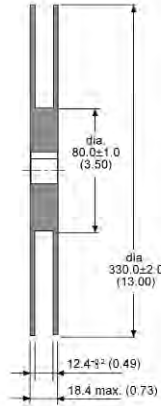
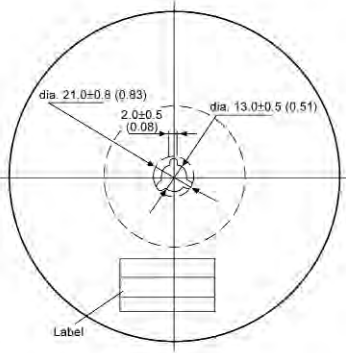

Tape
Figure 1

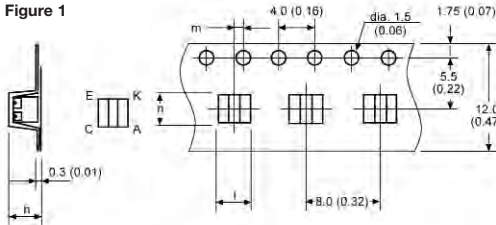

Part No.	<i>h</i>	<i>i</i>	<i>m</i>	<i>n</i>
EE-SX1107	3.2 (0.13)	3.6 (0.14)	0.9 (0.04)	3.2 (0.13)
EE-SX1108	4.2 (0.17)	5.2 (0.20)	0.25 (0.01)	4.2 (0.17)
EE-SX1131	4.2 (0.17)	5.2 (0.20)	0.25 (0.01)	4.2 (0.17)

Tape
Figure 2

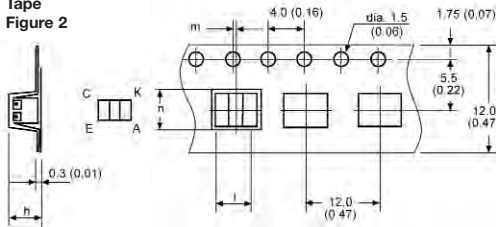

Part No.	<i>h</i>	<i>i</i>	<i>m</i>	<i>n</i>
EE-SX1109	5.2 (0.20)	6.2 (0.24)	0.25 (0.01)	4.2 (0.17)

Tape configuration

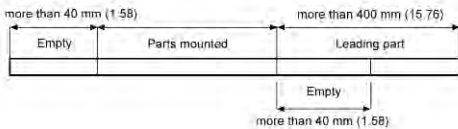

Part No.	Pieces per reel
EE-SX1107	2500
EE-SX1108/1131	2000
EE-SX1109	1000

Precautions

■ Soldering Information

Reflow soldering

- The following soldering paste is recommended:
Melting temperature: 216 to 220°C
Composition: Sn 3.5 Ag, 0.75 Cu
- The recommended thickness of the metal mask for screen printing is between 0.2 and 0.25 mm.
- Set the reflow oven so that the temperature profile shown in the following chart is obtained for the upper surface of the product being soldered.

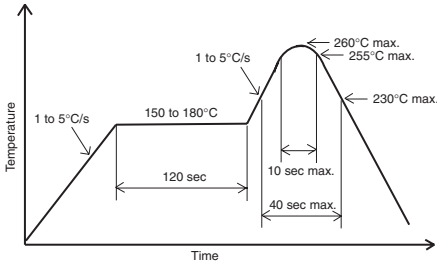

Manual soldering

- Use "Sn 60" (60% tin and 40% lead) or solder with silver content.
- Use a soldering iron of less than 25W, and keep the temperature of the iron tip at 350°C or below.
- Solder each point for a maximum of three seconds.
- After soldering, allow the product to return to room temperature before handling it.

Storage

To protect the product from the effects of humidity until the package is opened, dry-box storage is recommended. If this is not possible, store the product under the following conditions:

Temperature: 10 to 30°C
Humidity: 60% max.

The product is packed in a humidity-proof envelope. Reflow soldering must be done within 48 hours after opening the envelope, during which time the product must be stored under 30°C at 80% maximum humidity.

If it is necessary to store the product after opening the envelope, use dry-box storage or reseal the envelope.

Baking

If a product has remained packed in a humidity-proof envelope for six months or more, or if more than 48 hours have lapsed since the envelope was opened, bake the product under the following conditions before use:

Reel: 60°C for 24 hours or more
Bulk: 80°C for 4 hours or more

ALL DIMENSIONS SHOWN ARE IN MILLIMETRES.

To convert millimetres into inches, multiply by 0.03937. To convert grams into ounces, multiply by 0.03527.