

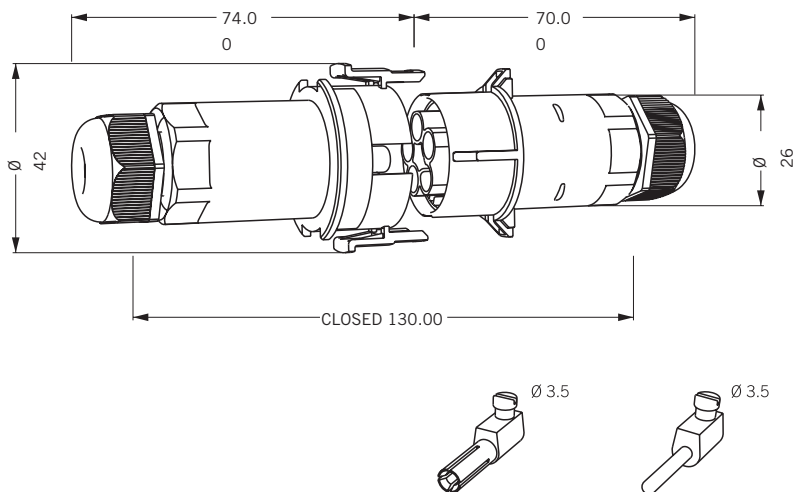

TH404

PATENTED IP65

5 poli



Connessione presa-spina 5 poli. Grado di protezione IP65.
Facilità di cablaggio. Connessione a bussola o faston.
Kit di fornitura: frutti non inseriti.

*5 poles connection socket-plug.
IP 65 protection. Easy wiring.
Supply kit: modules not inserted.*

Dati tecnici - Technical data(*)

16A	1,5[□]	400V ~	IP65
Materia plastica - Plastic Material PA66 UL94 V2 GWT 850°C			
Nero - Black	} -20°C		
Grigio - Grey RAL 7035			
AG= Ottone nichelato Nickled brass	} +125°C		
Ottone Argentato Silverplated brass			
Acciaio zincato passivato Zinc passivated steel	M3		
Rated current	16A		
Rated impulse voltage	6KV		
Impulse withstand voltage	7,3KV		
Range of temperature	0-85°C		
Cable max	5G1,5 H07RN-F		

Codice - Part number

T H B . 4 0 4 . X X A

Min-Max Ø cavo - cable Ø 5÷14 mm



PLUG



POWER-SOCKET

THB.404.A2A	Nero - Black	
THB.404.A2A.AG	Grigio - Grey RAL 7035	
THB.404.A2C	Nero - Black	
THB.404.A2C.AG		
THB.404.B2A	Nero - Black	
THB.404.B2A.AG		
THB.404.B2C	Grigio - Grey RAL 7035	
THB.404.B2C.AG		

*frutti intercambiabili - interchangeable fruits
gommino doppio - double seal*



Solo per THB...
Only for THB...

Codice - Part number

T H F . 4 0 4 . X X A

Min-Max Ø cavo - cable Ø 5÷14 mm



PLUG



POWER-SOCKET

THF.404.A2A	Nero - Black	
THF.404.A2C	Grigio - Grey RAL 7035	
THF.404.B2A	Nero - Black	
THF.404.B2C		

*frutti intercambiabili - interchangeable fruits
gommino doppio - double seal*

IP65

Per faston cilindrici universali Ø2
For universal cylindric faston Ø2



(*)EN 61984-2001

Eventuali modifiche e migliorie sui dati tecnici o sul prodotto potranno essere effettuate senza preavviso.
All technical data or other eventual product modifications and improvements can be carried out without notice
Techno S.r.l. - technology & innovation - tel. +39.031.976445 - www.techno.it - info@techno.it

Accessori - Accessories



6DB000800 Double Yellow Seal \varnothing_e 15,5 - \varnothing_i 8
 \varnothing 5 \pm 14mm



6000092CC Nero - Black
6000092CE Grigio - Grey 7035

Foro - Hole \varnothing 14 CH **24mm**



604001400 Guarnizione rossa - Red Seal
 \varnothing_e 28,5 - \varnothing_i 25 - SP.2



6000087LF Riduzione per dado
 Adapter for nut

Foro - Hole \varnothing 9 CH **24mm**



604001500 Guarnizione rossa - Red Seal
 OR \varnothing 23,52 x 1,78



600009600 Chiave per agganciare i frutti
 Modules adapter
 5 poli - 5 poles

Istruzioni di montaggio - Assembling Instructions

- ① Spelatura cavi.
 Cables stripping.

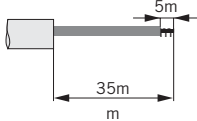

- ② Preparazione frutto.
 Plug-in module preparation.

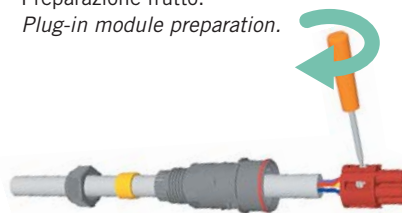

- ③ Inserimento frutto nel corpo rispettando i riferimenti.
 Fitting of the plug-in module inside the body in accordance with the reference marks.

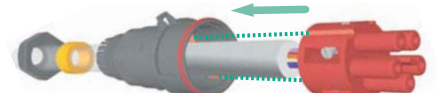

- ④ Il bloccaggio del frutto nel corpo può essere fatto:
 a) Ruotando il cavo in senso orario fino al CLICK
 b) Ruotando il frutto in senso antiorario fino al CLICK
 The modules clamping in the body can be done by:
 a) Turning the cable in clockwise (CLICK)
 b) Turning modules in anticlockwise (CLICK)

- b) Con un cacciavite
 With screwdriver

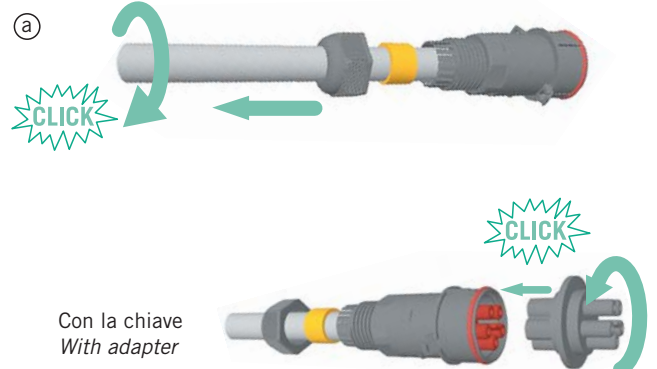

- ⑤ Posizionare la guarnizione e avvitare il dado.
 Position the seal then block the cable with the nut.

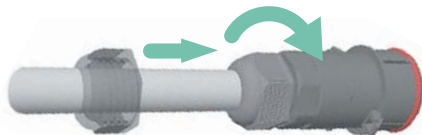

- ⑥ Intercambiabilità frutto maschio con frutto femmina.
 Interchangeability between plug and socket modules.



- ⑦ Connessione rispettando la polarizzazione.
 Connection in accordance with the polarization.

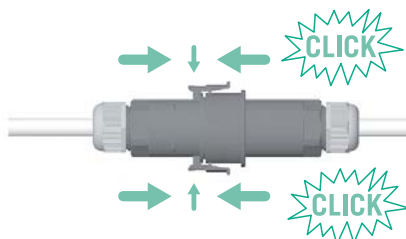

- ⑧ Per disconnettere sollevare le due alette. Attenzione: essendo una connessione a tenuta d'acqua, gli accoppiamenti devono necessariamente frizionare. To disconnect lift the two wings. Attention: being a watertight device, the connections would be necessary frictional.

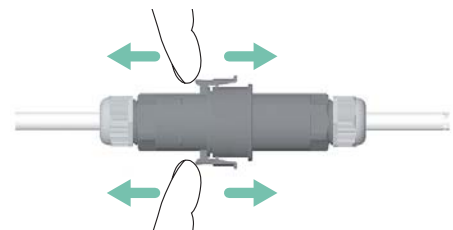

ABOUT US

Hylec-APL is a well established Component Distributor specialising in the bulk supply of Terminal Blocks, Connectors and Cable Glands to major OEM's, Sub-Contractor Manufacturers and leading Distribution organisations into both the Electromechanical and the Electronics sectors.

Hylec APL can provide a wide range of product options and application solutions including access to many thousands of line items from its extensive and largely exclusive supplier base. Hylec APL maintains a large UK stock profile at its base in Northants, which is geared to reflect popular market demand whilst offering enhanced product availability to its many customers.

In addition to its core product lines of Terminal Blocks and Connectors – both Electromechanical and Electronic variants - Cable Glands and Cable entry components, Hylec APL has recently extended its range to include LED's, Switches, Buzzers, Relays, Fuses and DIN Rail Mounting Enclosures. This evolutionary development is designed to not only widen market appeal but also to provide the customer with greater choice, the potential for supplier consolidation and the commercial benefits of economies of scale.

Subject to availability, delivery methods include next day carrier as standard and customer specific options, such as special packaging requirements, can be readily considered.

Product choice is supported by a wealth of product knowledge and application experience, and our technical sales team will be only too pleased to assist in the process of correct product selection.

The vast majority of products hold recognised Industrial Safety Approvals and these together with samples can be supplied upon request.

Value for money consistent with the supply of the highest possible quality of products and service is our number one priority.



APL

Hylec Components Ltd - Andromeda Products Ltd

T: +44 (0)1933 234400 ■ F: +44 (0)1933 234411
E: sales@hylec-apl.com ■ W: www.hylec-apl.com



MAKING THE RIGHT CONNECTIONS