



C2M0080120D

Silicon Carbide Power MOSFET Z-FET™ MOSFET

N-Channel Enhancement Mode

Features

- High Speed Switching with Low Capacitances
- High Blocking Voltage with Low $R_{DS(on)}$
- Easy to Parallel and Simple to Drive
- Avalanche Ruggedness
- Resistant to Latch-Up
- Halogen Free, RoHS Compliant

Benefits

- Higher System Efficiency
- Reduced Cooling Requirements
- Increased System Switching Frequency

Applications

- Solar Inverters
- High Voltage DC/DC Converters
- Motor Drives
- Switch Mode Power Supplies
- UPS

Maximum Ratings ($T_c = 25^\circ\text{C}$ unless otherwise specified)

Symbol	Parameter	Value	Unit	Test Conditions	Note
$I_{DS(DC)}$	Continuous Drain Current	31.6	A	$V_{GS}@20\text{ V}, T_c = 25^\circ\text{C}$	Fig. 17
		20		$V_{GS}@20\text{ V}, T_c = 100^\circ\text{C}$	
$I_{DS(pulse)}$	Pulsed Drain Current	60	A	Pulse width t_p limited by T_{jmax} $T_c = 25^\circ\text{C}$	
E_{AS}	Single Pulse Avalanche Energy	TBD	J	$I_D = 20\text{ A}, V_{DD} = 50\text{ V},$ $L = 9.5\text{ mH}$	
E_{AR}	Repetitive Avalanche Energy	TBD	J	t_{AR} limited by T_{jmax}	
I_{AR}	Repetitive Avalanche Current	TBD	A	$I_D = 20\text{ A}, V_{DD} = 50\text{ V}, L = 3\text{ mH}$ t_{AR} limited by T_{jmax}	
V_{GS}	Gate Source Voltage	-10/+25	V		
P_{tot}	Power Dissipation	208	W	$T_c=25^\circ\text{C}$	Fig. 16
T_j, T_{stg}	Operating Junction and Storage Temperature	-55 to +150	$^\circ\text{C}$		
T_L	Solder Temperature	260	$^\circ\text{C}$	1.6mm (0.063") from case for 10s	
M_d	Mounting Torque	1	Nm lbf-in	M3 or 6-32 screw	
		8.8			

V_{DS}	1200 V
$I_D @ 25^\circ\text{C}$	31.6 A
$R_{DS(on)}$	80 m Ω

Package

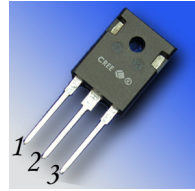

TO-247-3

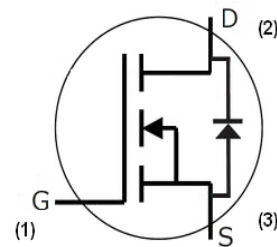

Part Number	Package
C2M0080120D	TO-247-3



Electrical Characteristics (T_C = 25°C unless otherwise specified)

Symbol	Parameter	Min.	Typ.	Max.	Unit	Test Conditions	Note
V _{(BR)DSS}	Drain-Source Breakdown Voltage	1200			V	V _{GS} = 0 V, I _D = 100 μA	
V _{GS(th)}	Gate Threshold Voltage	1.7	2.2		V	V _{DS} = 10V, I _D = 1 mA	Fig. 7
			3.2		V	V _{DS} = 10V, I _D = 10 mA	
		1.2	1.7		V	V _{DS} = 10V, I _D = 1 mA, T _J = 150°C	
			TBD		V	V _{DS} = 10V, I _D = 10 mA, T _J = 150°C	
I _{DSS}	Zero Gate Voltage Drain Current		1	100	μA	V _{DS} = 1200 V, V _{GS} = 0 V	
			10	250		V _{DS} = 1200 V, V _{GS} = 0 V T _J = 150°C	
I _{GSS}	Gate-Source Leakage Current			0.25	μA	V _{GS} = 20 V, V _{DS} = 0 V	
R _{DS(on)}	Drain-Source On-State Resistance		80	98	mΩ	V _{GS} = 20 V, I _D = 20 A	Fig. 4
			150	208		V _{GS} = 20 V, I _D = 20A, T _J = 150°C	
g _{fs}	Transconductance		9.8		S	V _{DS} = 20 V, I _{DS} = 20 A	Fig. 6
			8.5			V _{DS} = 20 V, I _{DS} = 20 A, T _J = 150°C	
C _{iss}	Input Capacitance		950		pF	V _{GS} = 0 V V _{DS} = 1000 V f = 1 MHz	Fig. 15
C _{oss}	Output Capacitance		80				
C _{rss}	Reverse Transfer Capacitance		6.5				
E _{oss}	C _{oss} Stored Energy		40				μJ
t _{d(on)v}	Turn-On Delay Time		12.0		ns	V _{DD} = 800 V, V _{GS} = 0/20 V I _D = 20 A R _{G(ext)} = 0 Ω, R _L = 40 Ω Timing relative to V _{DS}	Fig. 21
t _{fv}	Fall Time		18.4				
t _{d(off)v}	Turn-Off Delay Time		23.2				
t _{rv}	Rise Time		13.6				
R _G	Internal Gate Resistance		4.6		Ω	f = 1 MHz, V _{AC} = 25 mV	

Built-in SiC Body Diode Characteristics

Symbol	Parameter	Typ.	Max.	Unit	Test Conditions	Note
V _{SD}	Diode Forward Voltage	3.3		V	V _{GS} = -5 V, I _F = 10 A, T _J = 25 °C	Fig. 9
		3.1			V _{GS} = -2 V, I _F = 10 A, T _J = 25 °C	
t _{rr}	Reverse Recovery Time	40		ns	V _{GS} = -5 V, I _F = 20 A, T _J = 25 °C V _R = 800 V, di _r /dt = 350 A/μs	Fig. 27
Q _{rr}	Reverse Recovery Charge	165		nC		
I _{rrm}	Peak Reverse Recovery Current	6.4		A		

Thermal Characteristics

Symbol	Parameter	Typ.	Max.	Unit	Test Conditions	Note
R _{θJC}	Thermal Resistance from Junction to Case	0.60	0.65	K/W		Fig. 18
R _{θCS}	Case to Sink, w/ Thermal Compound	TBD				
R _{θJA}	Thermal Resistance From Junction to Ambient		40			

Gate Charge Characteristics

Symbol	Parameter	Typ.	Max.	Unit	Test Conditions	Note
Q _{gs}	Gate to Source Charge	10.8		nC	V _{DS} = 800 V, V _{GS} = 0/20 V I _D = 20 A Per JEDEC24 pg 27	Fig. 20
Q _{gd}	Gate to Drain Charge	18.0				
Q _g	Gate Charge Total	49.2				

Typical Performance

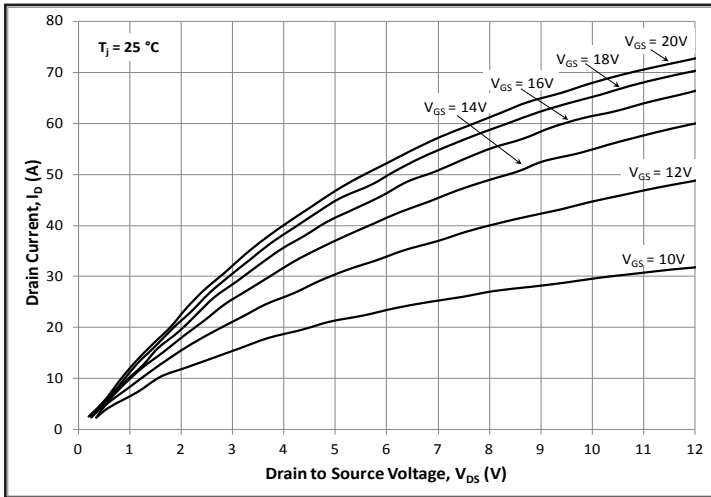

Figure 1. Typical Output Characteristics $T_j = 25\text{ }^\circ\text{C}$

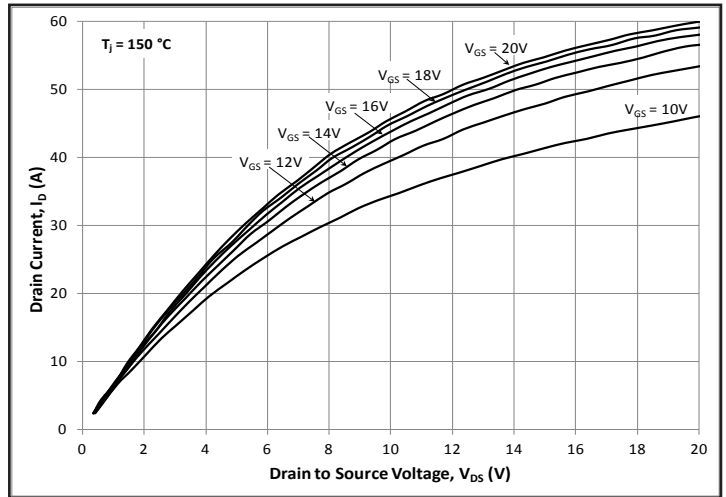

Figure 2. Typical Output Characteristics $T_j = 150\text{ }^\circ\text{C}$

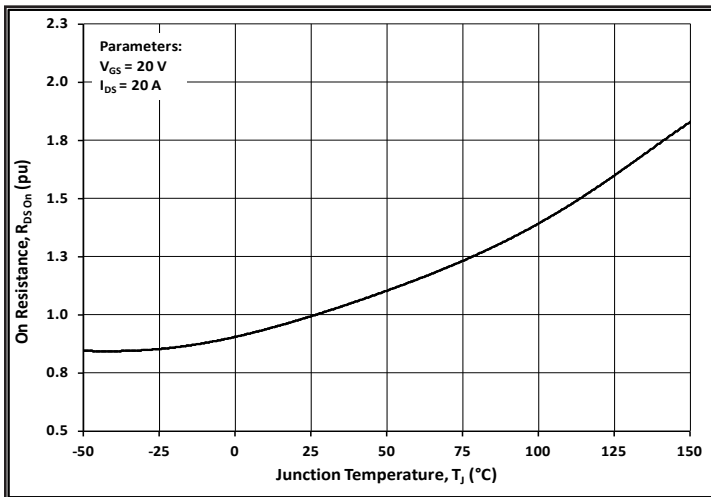

Figure 3. Normalized On-Resistance vs. Temperature

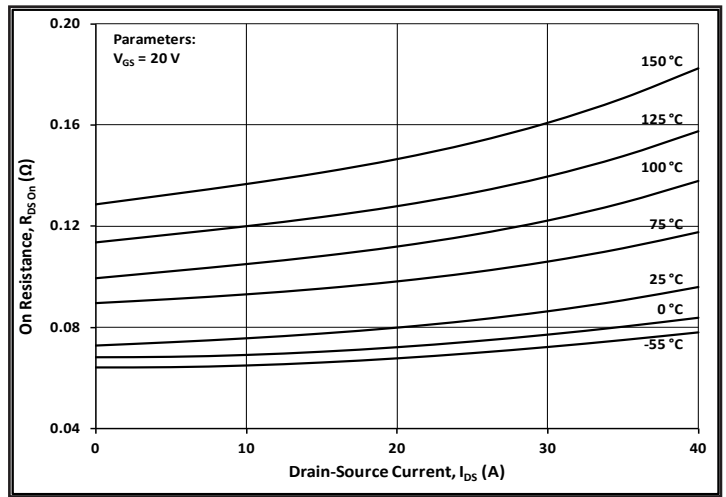

Figure 4. On-Resistance vs. Drain Current

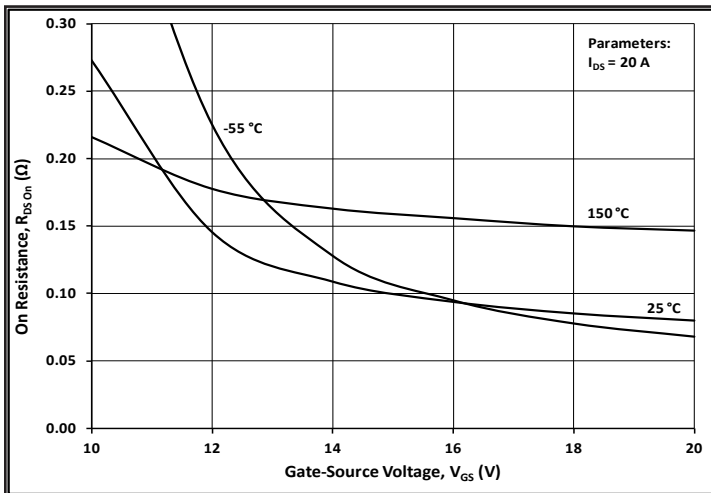

Figure 5. On-Resistance vs. Gate Voltage

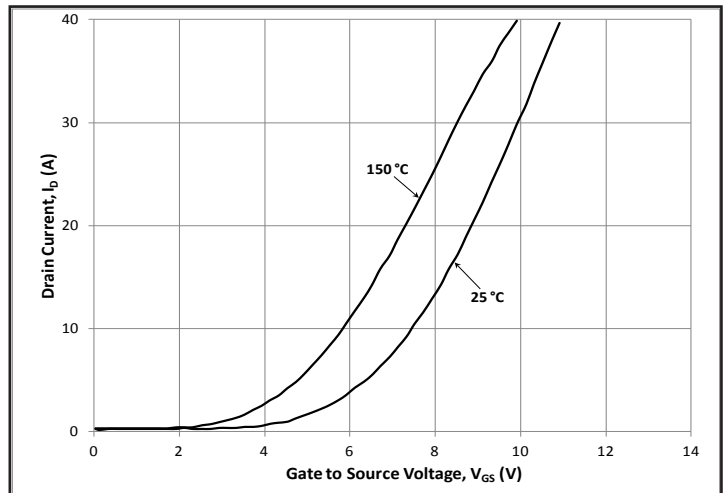

Figure 6. Typical Transfer Characteristics

Typical Performance

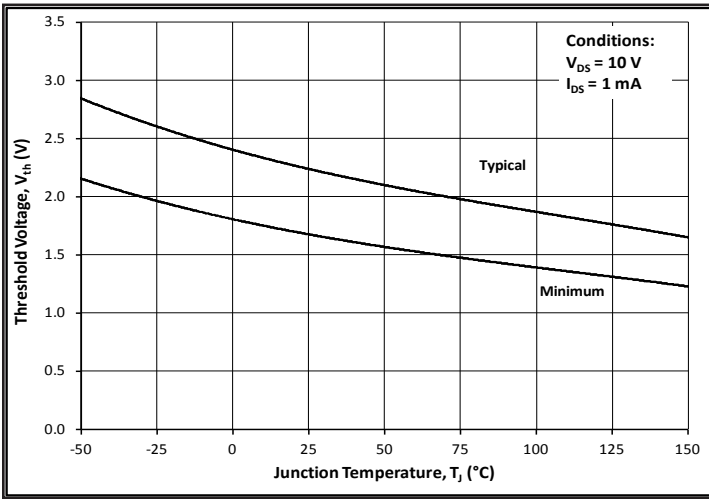

Figure 7. Typical and Minimum Threshold Voltage vs. Temperature

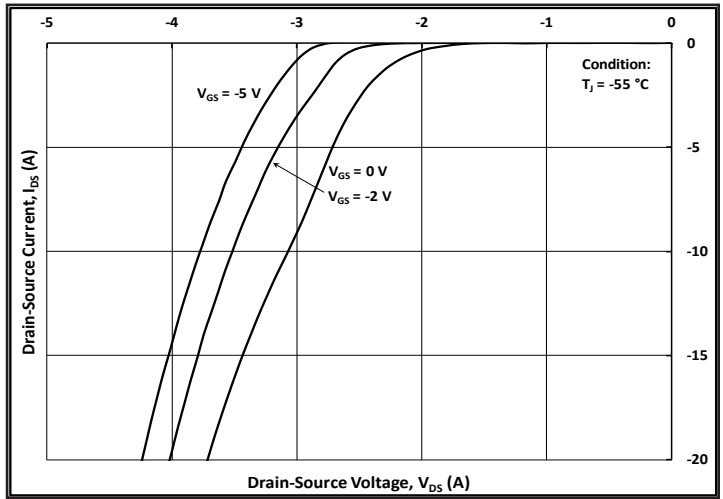

Figure 8. Typical Body Diode Characteristics $T_j = -55\text{ }^\circ\text{C}$

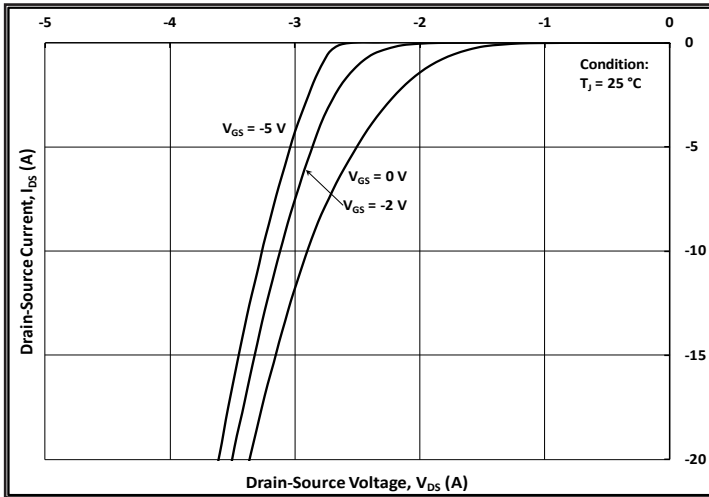

Figure 9. Typical Body Diode Characteristics $T_j = 25\text{ }^\circ\text{C}$

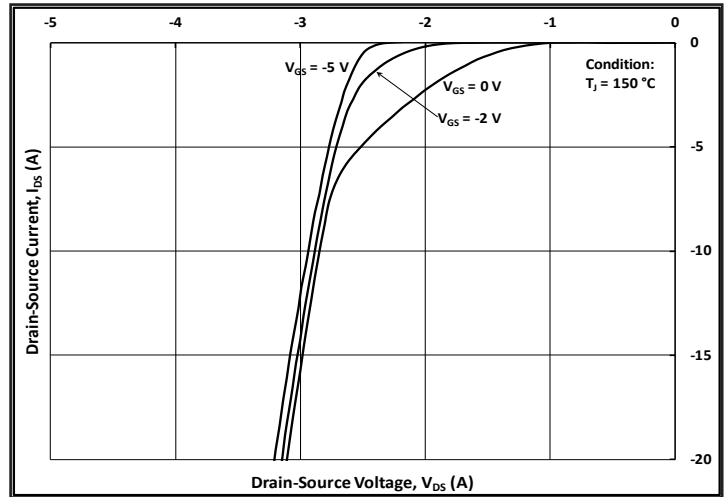

Figure 10. Typical Body Diode Characteristics $T_j = 150\text{ }^\circ\text{C}$

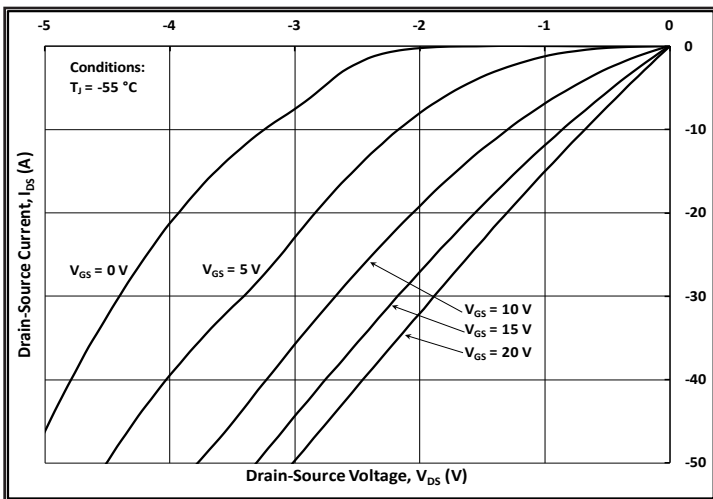

Figure 11. Typical 3rd Quadrant Characteristics $T_j = -55\text{ }^\circ\text{C}$

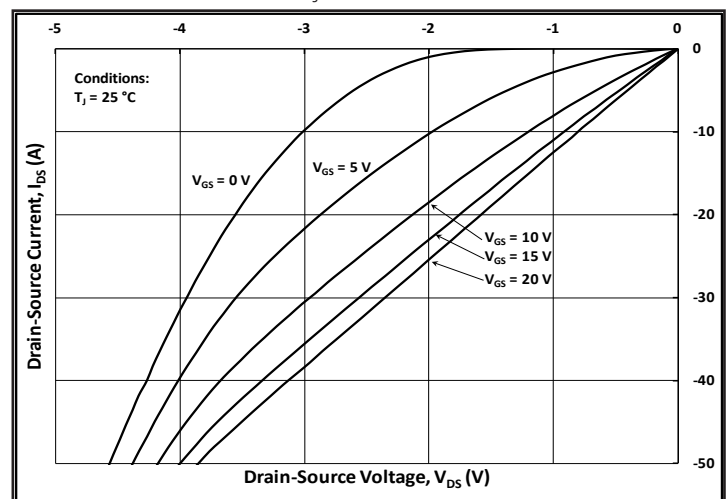

Figure 12. Typical 3rd Quadrant Characteristics $T_j = 25\text{ }^\circ\text{C}$

Typical Performance

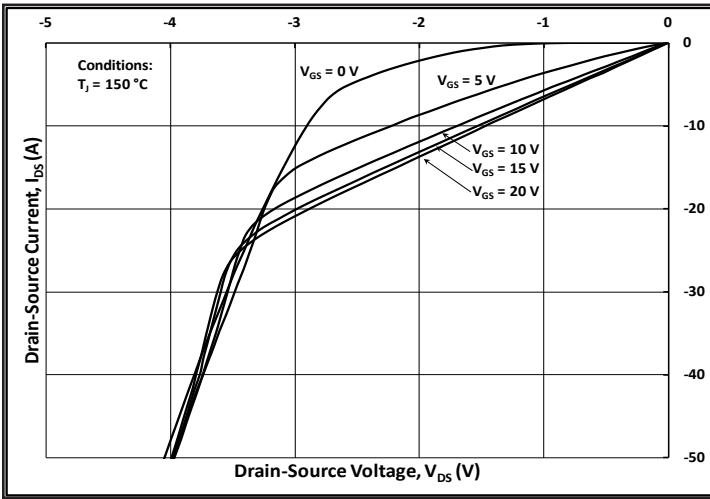

Figure 13. Typical 3rd Quadrant Characteristics
 $T_J = 150\text{ }^\circ\text{C}$

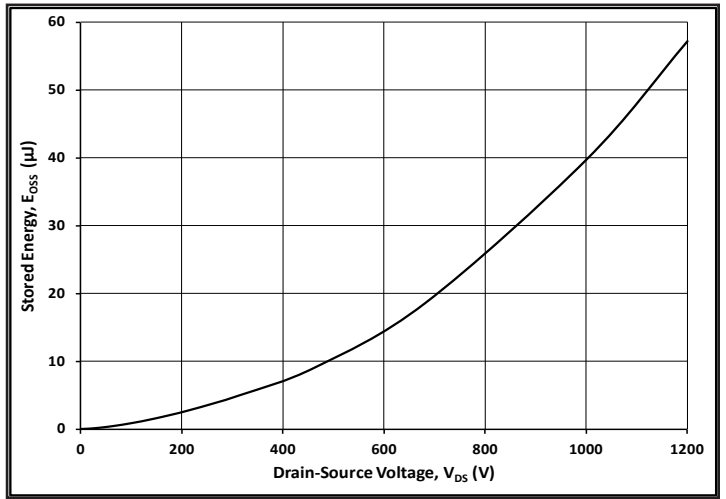

Figure 14. Typical transfer Characteristics

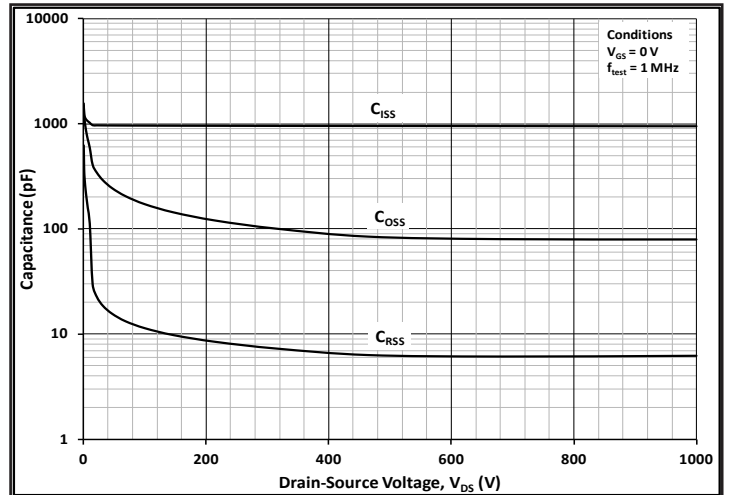
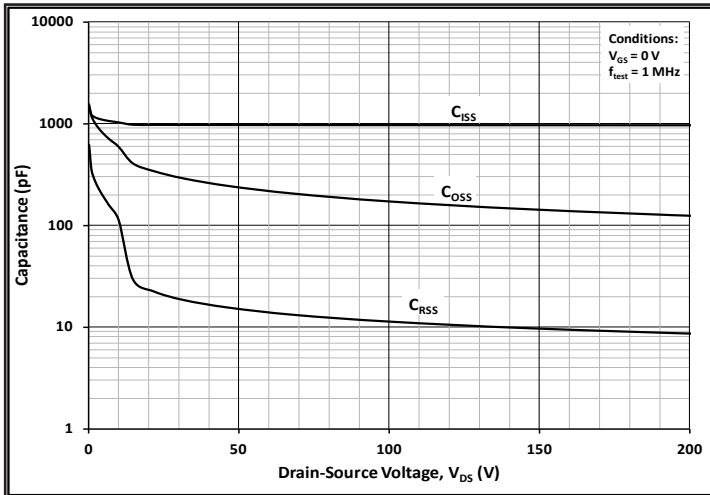

Figure 15A and 15B. Typical Capacitances vs. Drain Voltage at $V_{GS} = 0\text{ V}$ and $f = 1\text{ MHz}$

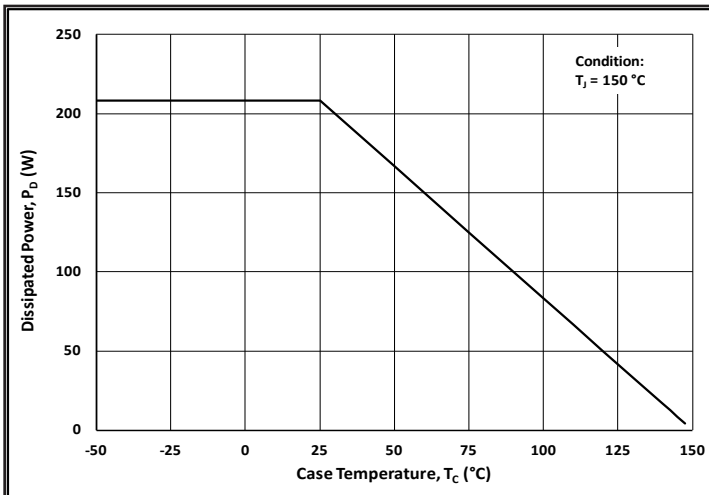

Figure 16. Power Dissipation Derating Curve

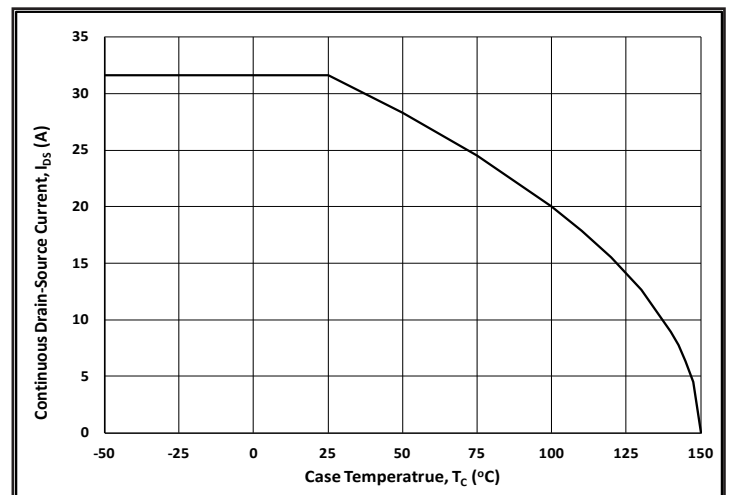

Figure 17. Continuous Current Derating Curve

Typical Performance

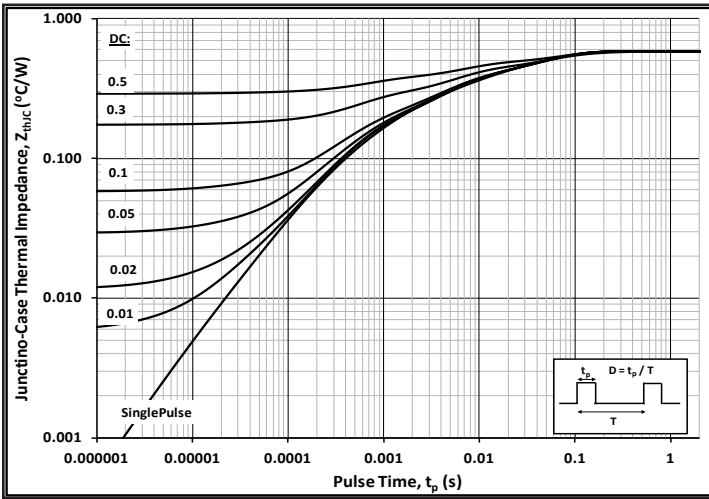

Figure 18. Typical Transient Thermal Impedance (Junction - Case) with Duty Cycle

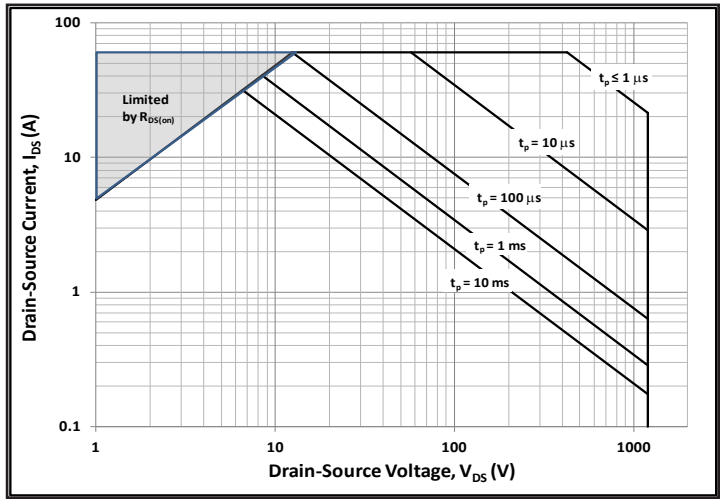

Figure 19. Safe Operating Area

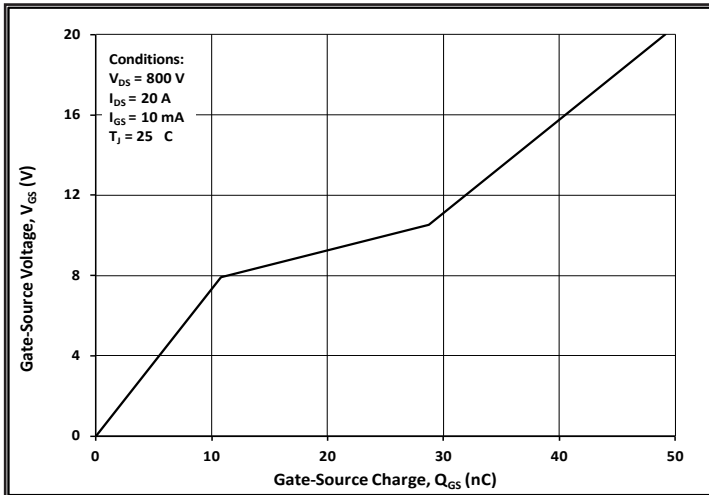

Figure 20. Typical Gate Characteristic 25 °C

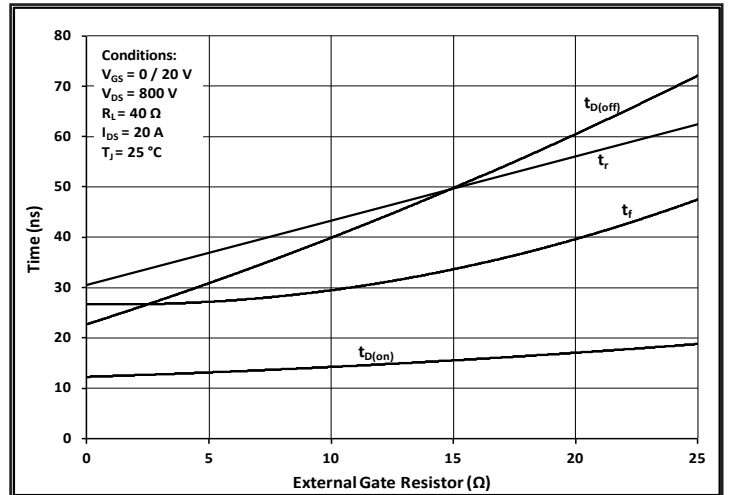

Figure 21. Resistive Switching Times vs. R_G

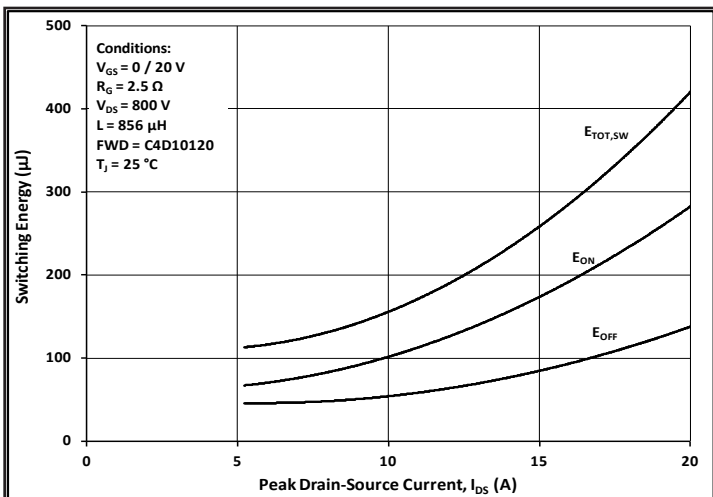

Figure 22. Clamped Inductive Switching Energy vs. Drain Current (Fig. 24)

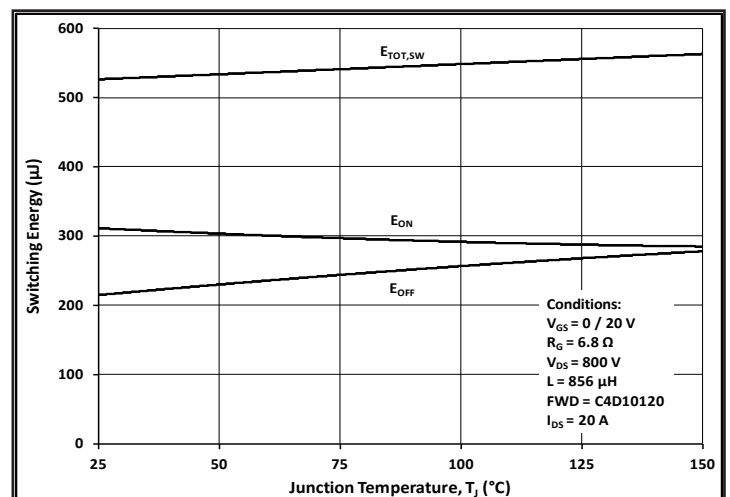

Figure 23. Clamped Inductive Switching Energy vs. Junction Temperature (Fig. 24)

Typical Performance

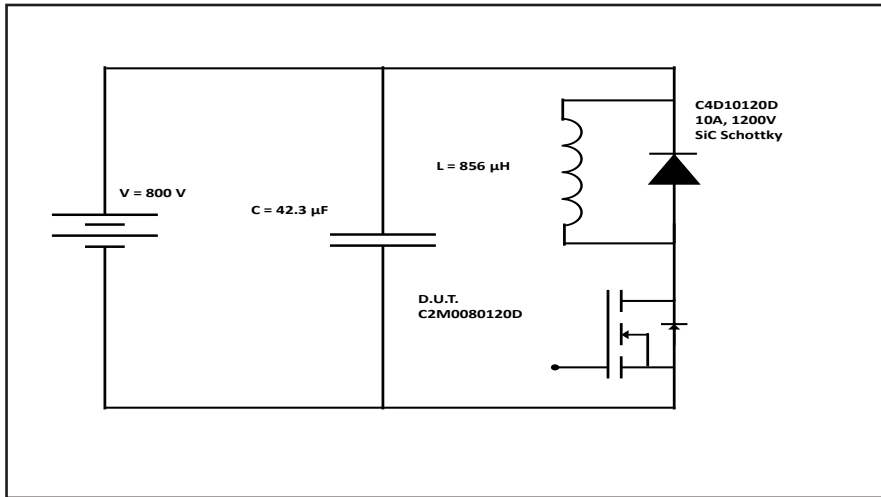

Figure 24. Clamped Inductive Switching Waveform Test Circuit

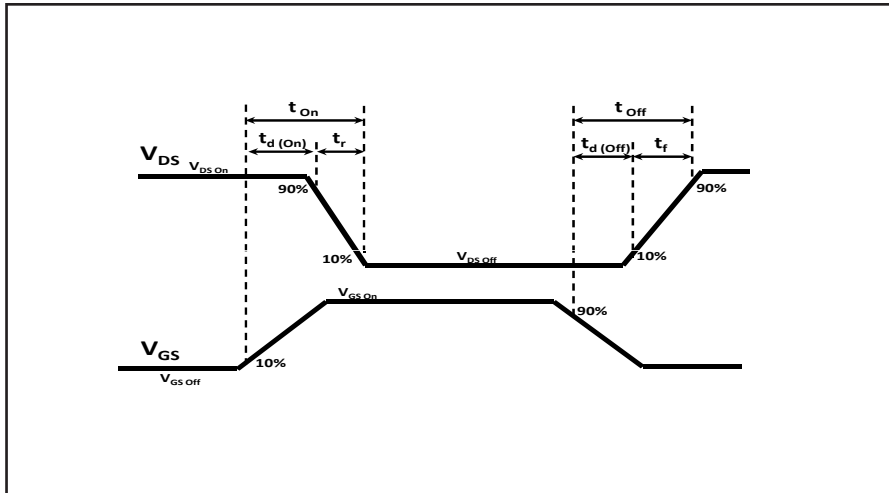

Figure 25. Switching Test Waveforms for Transition Times

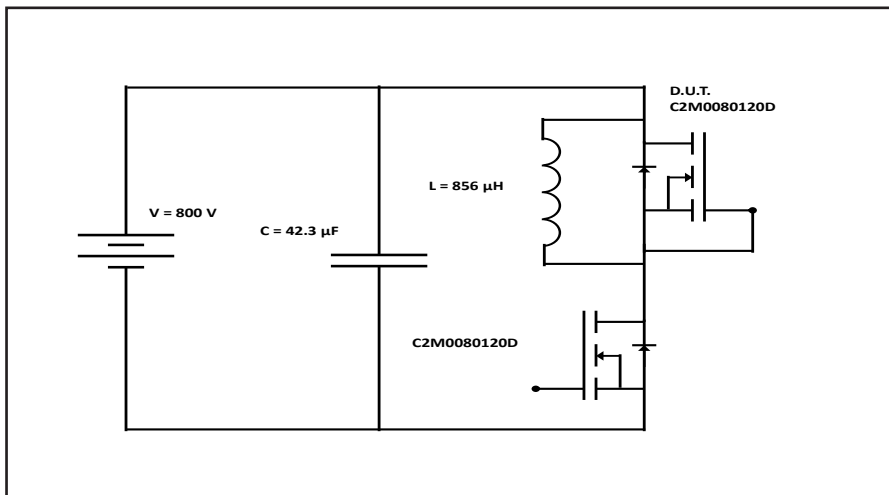

Figure 26. Body Diode Recovery Test Circuit

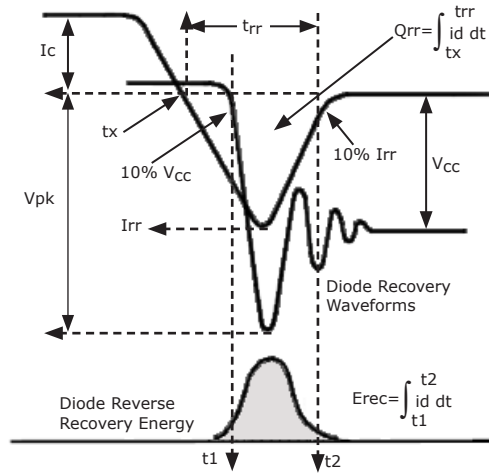

Figure 27. Body Diode Recovery Waveform

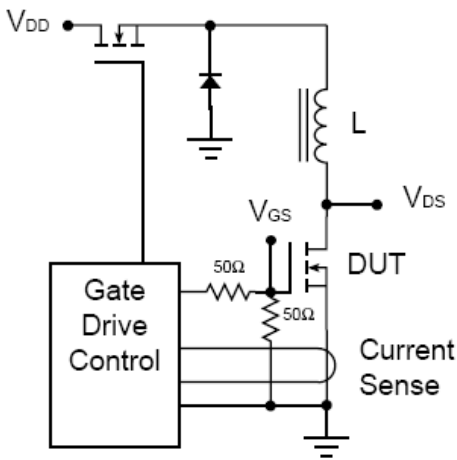
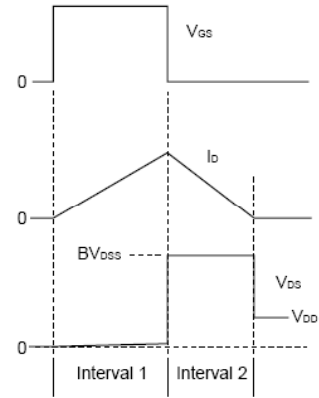

Figure 28. Unclamped Inductive Switching Test Circuit



$$E_A = 1/2L \times I_D^2$$

Figure 29. Unclamped Inductive Switching waveform for Avalanche Energy

ESD Ratings

ESD Test	Total Devices Sampled	Resulting Classification
ESD-HBM	All Devices Passed 1000V	2 (>2000V)
ESD-MM	All Devices Passed 400V	C (>400V)
ESD-CDM	All Devices Passed 1000V	IV (>1000V)

Package Dimensions

Package TO-247-3

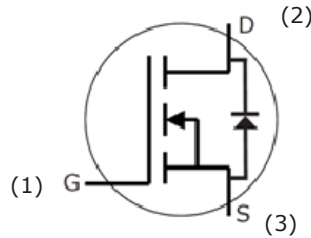
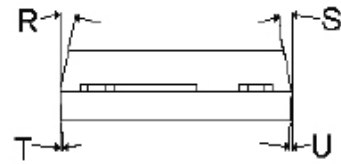
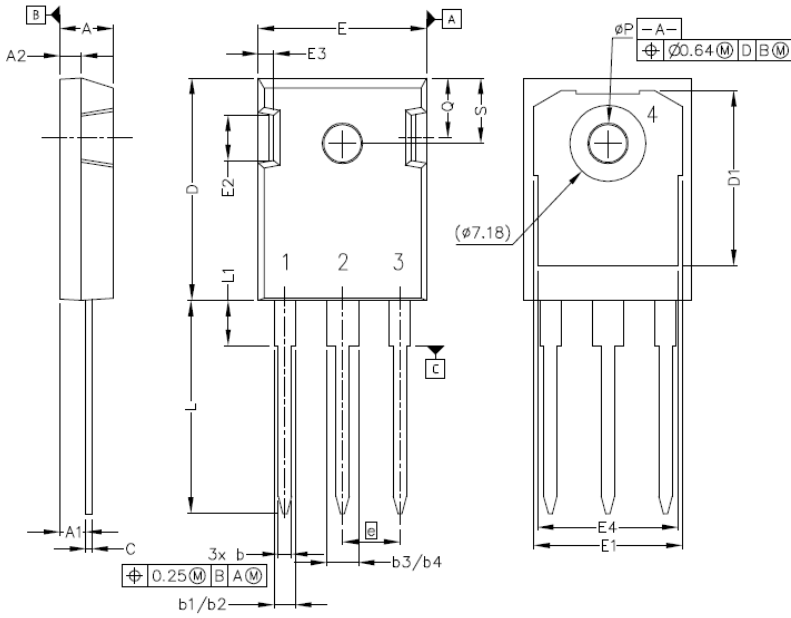

POS	Inches		Millimeters	
	Min	Max	Min	Max
A	.190	.205	4.83	5.21
A1	.090	.100	2.29	2.54
A2	.075	.085	1.91	2.16
b	.042	.052	1.07	1.33
b1	.075	.095	1.91	2.41
b2	.075	.085	1.91	2.16
b3	.113	.133	2.87	3.38
b4	.113	.123	2.87	3.13
c	.022	.027	0.55	0.68
D	.819	.831	20.80	21.10
D1	.640	.695	16.25	17.65
D2	.037	.049	0.95	1.25
E	.620	.635	15.75	16.13
E1	.516	.557	13.10	14.15
E2	.145	.201	3.68	5.10
E3	.039	.075	1.00	1.90
E4	.487	.529	12.38	13.43
e	.214 BSC		5.44 BSC	
N	3		3	
L	.780	.800	19.81	20.32
L1	.161	.173	4.10	4.40
ØP	.138	.144	3.51	3.65
Q	.216	.236	5.49	6.00
S	.238	.248	6.04	6.30

Recommended Solder Pad Layout

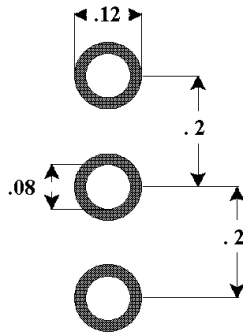

TO-247-3

Part Number	Package	Marking
C2M0080120D	TO-247-3	C2M0080120

This product has not been designed or tested for use in, and is not intended for use in, applications implanted into the human body nor in applications in which failure of the product could lead to death, personal injury or property damage, including but not limited to equipment used in the operation of nuclear facilities, life-support machines, cardiac defibrillators or similar emergency medical equipment, aircraft navigation or communication or control systems, air traffic control systems, or weapons systems.

Copyright © 2013 Cree, Inc. All rights reserved. The information in this document is subject to change without notice. Cree and the Cree logo are registered trademarks and Z-REC and Z-FET are trademarks of Cree, Inc.

Cree, Inc.
4600 Silicon Drive
Durham, NC 27703
USA Tel: +1.919.313.5300
Fax: +1.919.313.5451
www.cree.com/power