

# SK-16FX-48PMC

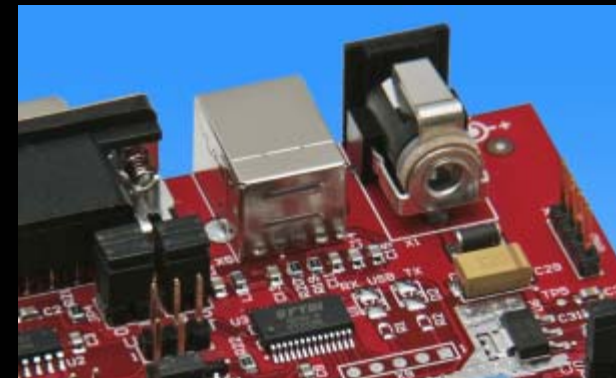

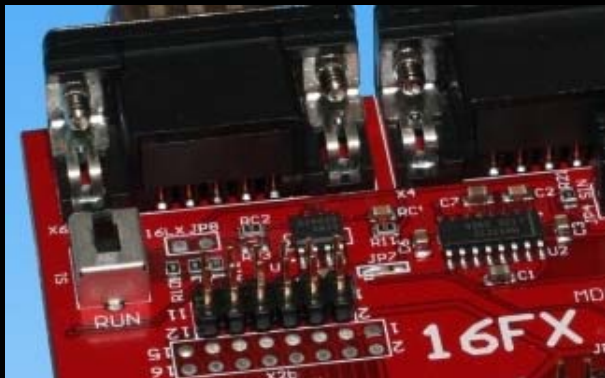
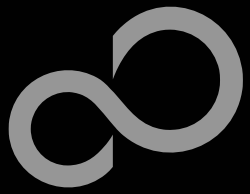

# Warranty and Disclaimer

The use of the deliverables (e.g. software, application examples, target boards, evaluation boards, starter kits, schematics, engineering samples of IC's etc.) is subject to the conditions of Fujitsu Semiconductor Europe GmbH ("FSEU") as set out in (i) the terms of the License Agreement and/or the Sale and Purchase Agreement under which agreements the Product has been delivered, (ii) the technical descriptions and (iii) all accompanying written materials.

Please note that the deliverables are intended for and must only be used for reference in an evaluation laboratory environment. The software deliverables are provided on an as-is basis without charge and are subject to alterations. It is the user's obligation to fully test the software in its environment and to ensure proper functionality, qualification and compliance with component specifications.

Regarding hardware deliverables, FSEU warrants that they will be free from defects in material and workmanship under use and service as specified in the accompanying written materials for a duration of 1 year from the date of receipt by the customer.

Should a hardware deliverable turn out to be defect, FSEU's entire liability and the customer's exclusive remedy shall be, at FSEU's sole discretion, either return of the purchase price and the license fee, or replacement of the hardware deliverable or parts thereof, if the deliverable is returned to FSEU in original packing and without further defects resulting from the customer's use or the transport. However, this warranty is excluded if the defect has resulted from an accident not attributable to FSEU, or abuse or misapplication attributable to the customer or any other third party not relating to FSEU or to unauthorised decompiling and/or reverse engineering and/or disassembling.

FSEU does not warrant that the deliverables do not infringe any third party intellectual property right (IPR). In the event that the deliverables infringe a third party IPR it is the sole responsibility of the customer to obtain necessary licenses to continue the usage of the deliverable.

In the event the software deliverables include the use of open source components, the provisions of the governing open source license agreement shall apply with respect to such software deliverables.

To the maximum extent permitted by applicable law FSEU disclaims all other warranties, whether express or implied, in particular, but not limited to, warranties of merchantability and fitness for a particular purpose for which the deliverables are not designated.

To the maximum extent permitted by applicable law, FSEU's liability is restricted to intention and gross negligence. FSEU is not liable for consequential damages.

Should one of the above stipulations be or become invalid and/or unenforceable, the remaining stipulations shall stay in full effect.

The contents of this document are subject to change without a prior notice, thus contact FSEU about the latest one.

**This board and its deliverables must only be used for test applications in an evaluation laboratory environment.**

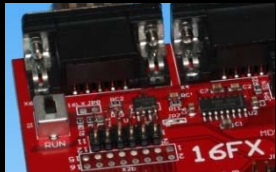

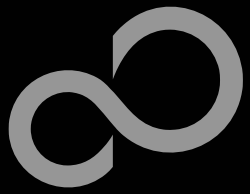

# Overview

## ■ Introduction

- Warranty and Disclaimer
- About the SK-16FX-48PMC
- SK-16FX-48PMC content
- Test it
- The hardware
- The software

## ■ Try yourself

- Software examples
- Program download
- New project
- EUROScope
- FreeRTOS

## ■ Optional tools

## ■ Contacts

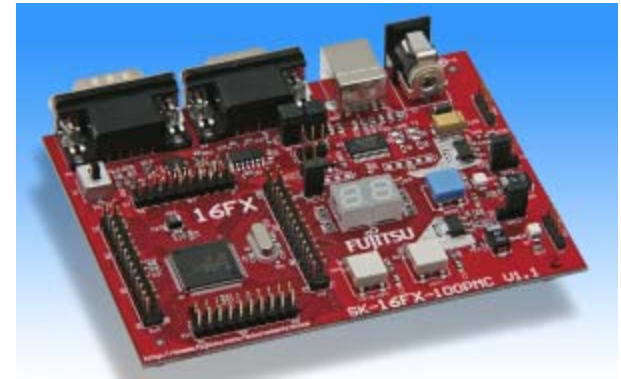

## ■ **Additional documents**

- Schematic 'SK-16FX-48PMC'
- Data sheet MB96310 Series
- Hardware manual 16FX Family
- AppNote '16FX Hardware Setup'
- AppNote '16FX Getting Started'
- Customer Information 16FX
- EUROScope Reference Manual
- AppNote 'EUROScope'
- Customer Information of 'EUROScope' limitations



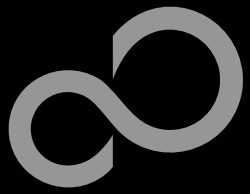

# About the SK-16FX-48PMC

- **The SK-16FX-48PMC includes a low-cost evaluation board based on the Fujitsu 16FX microcontroller MB96310 Series**

- **The MB96310 Series includes the following features:**

- Up to 160 KByte Flash Memory
- Up to 8 KByte RAM
- Up to 1 CAN controller 2.0B
- Up to 3 LIN-USART interfaces
- Timers (ICUs, OCUs, PPGs, others)
- ADC
- External interrupts
- Others

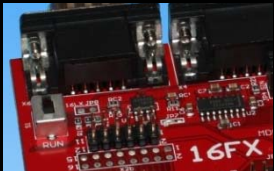

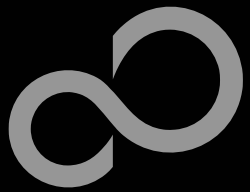

# About the SK-16FX-48PMC

## ■ Features of the SK-16FX-48PMC (EUROScope) board:

- Microcontroller MB96F315RSA
- 1x UART-Transceiver (SUB-D9 connector)
- 1x USB to serial converter (Type-B connector)
- 1x High-speed CAN-Transceiver (SUB-D9 connector)
- 2x LED-Display (7-Segment)
- 2x 'User'-buttons
- 1x 'Reset'-button, 'Reset'-LED
- All 48 pins routed to pin-header
- On-board 5V and 3V voltage regulators, 'Power'-LED
- USB power-supply (external power supply possible)

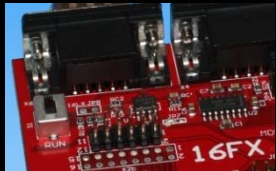
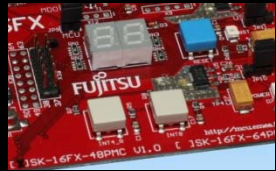

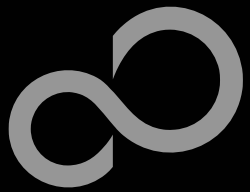

# SK-16FX-48PMC content

## ■ The SK-16FX-48PMC contains

- SK-16FX-48PMC evaluation board with MB96F315RSA
- USB cable, RS232 cable
- Mini CD
  - Documentation, USB driver, Softune Workbench, Examples
  - „EUROScope lite 16FX“

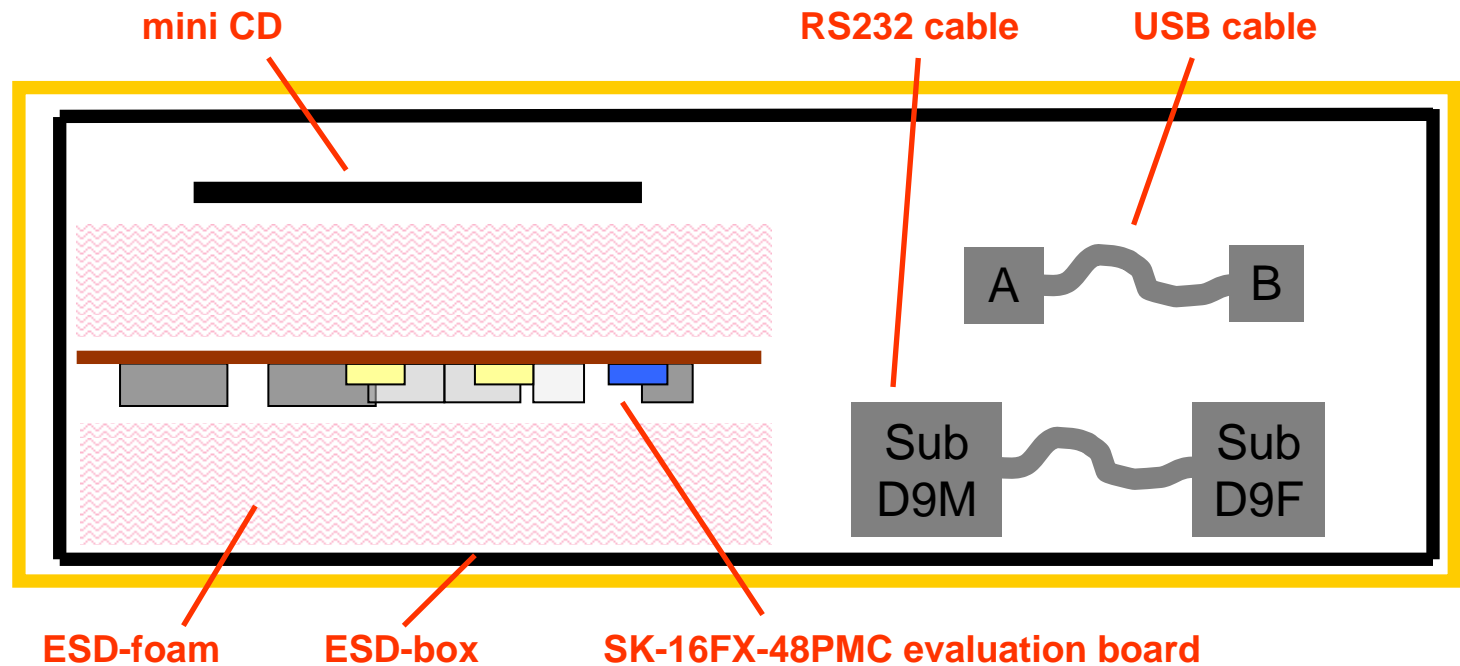

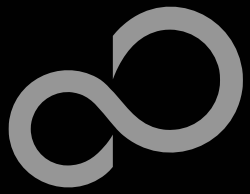

# Test it

- The microcontroller on the SK-16FX-48PMC is already preprogrammed with a simple application.

- Connect the USB cable to your PC and the SK-16FX-48PMC
- Install the USB driver from the CD
- Press the ,Reset'- Button
- The SK-16FX-48PMC will automatically start counting
- The count direction can be changed by pressing the key buttons

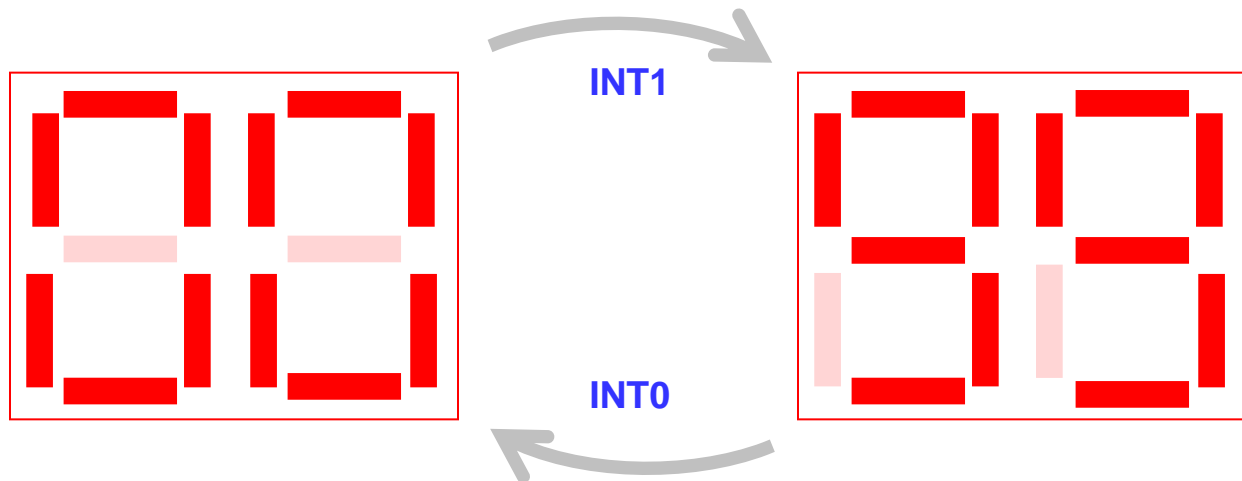



# Test it

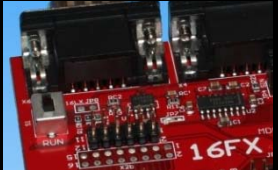
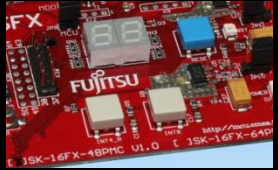

# Congratulations!

- You finished successfully the first test
- Now you will get more details about the SK-16FX-48PMC
- You will learn more about
  - The on-board features
  - How to program the Flash
  - How to start your own application
  - On-chip debugging with EUROScope



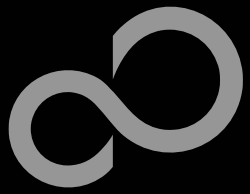

# The Hardware

## ■ Main features

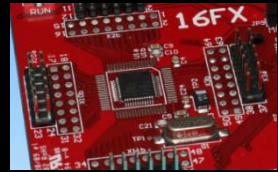
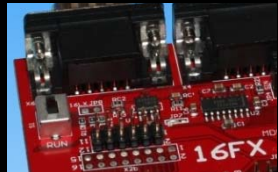

### 7-Segment Display

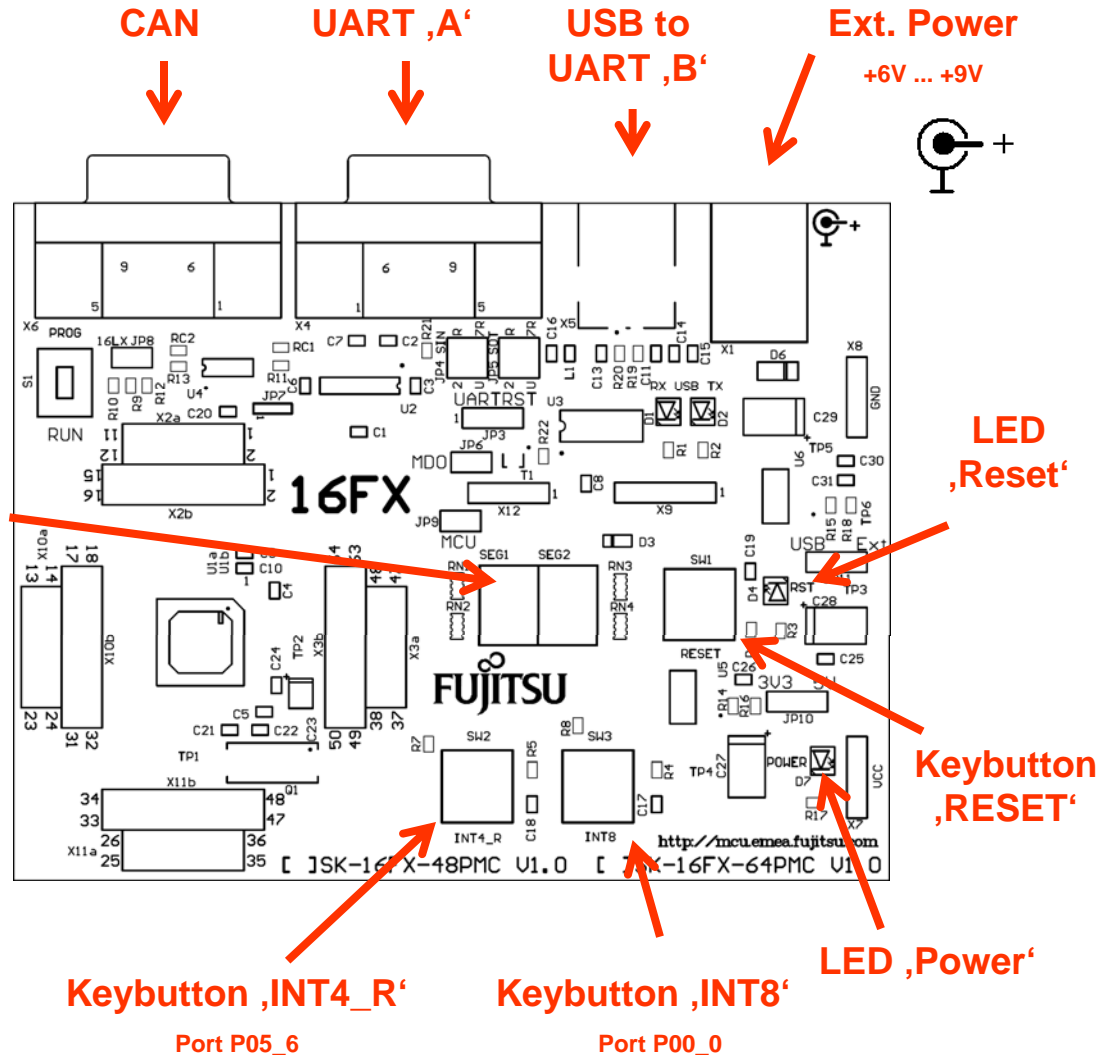
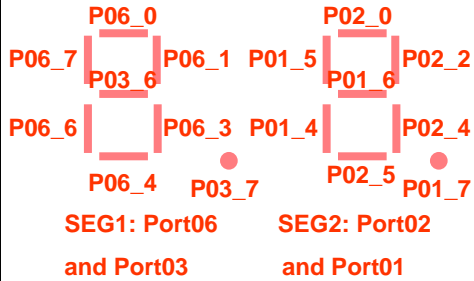

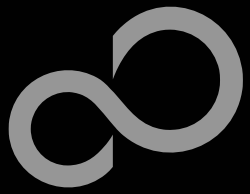

# The Hardware

## ■ The jumpers JP4: UART RX select

R-7R: UART7\_R=UART'A' / U-2: UART2=UART'B' (USB)

R-2: UART2=UART'A' / U-7R: UART7\_R=UART'B' (USB)

## JP5: UART TX select

R-7R: UART7\_R=UART'A' / U-2: UART2=UART'B' (USB)

R-2: UART2=UART'A' / U-7R: UART7\_R=UART'B' (USB)

## S1: Mode selection

PROG: Select the program-mode

RUN: Select the run-mode

## JP3: DTR-Reset

Set the jumper to 1-2 to connect the DTR-Signal of the UART connector to the microcontroller reset-pin.

Set the jumper to 2-3 to connect the DTR-Signal of the USB connector to the microcontroller reset-pin.

Some terminal-programs, e.g. Fujitsu's Skwizard, allow to reset the evaluation board by using the DTR-Signal.

## JP6: MD0 selection

Close this jumper to control the MD0 level by the RTS signal of the USB interface

## JP9: MCU Vcc

This jumper can be used to measure the current consumption of the MCU

## JP10: 5V / 3.3V

1-2: 5V supply is used  
2-3: 3.3V supply is used

## JP11: Power Supply

1-2: USB supply is used  
2-3: External supply is used

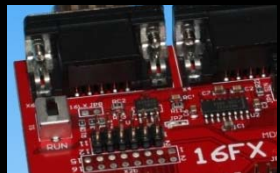
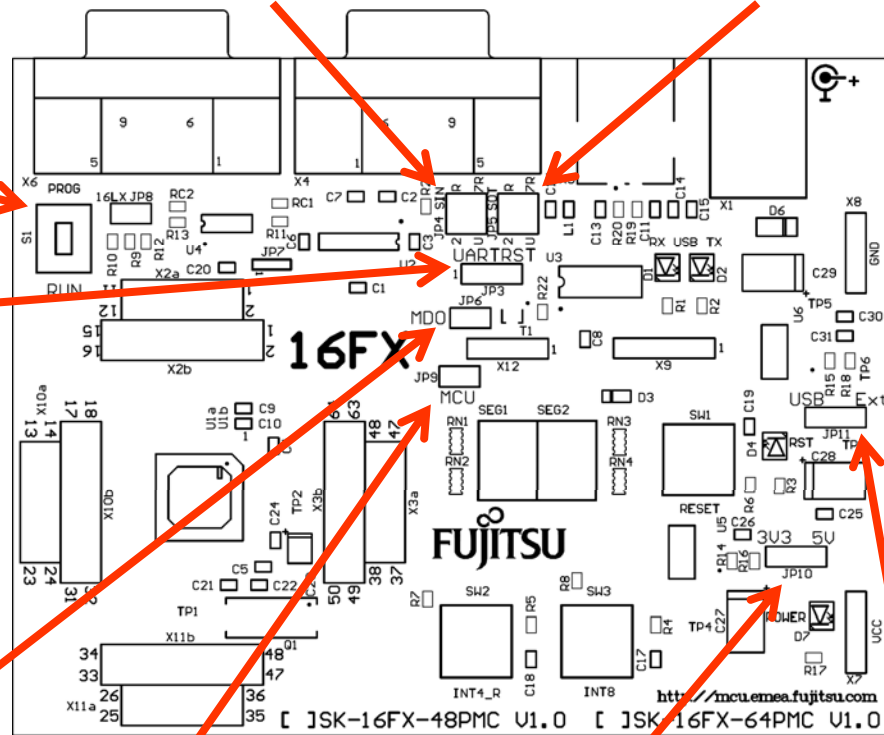

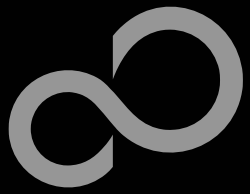

# The Hardware

## ■ JP4, JP5 : UART selection

- UART2 and UART7\_R of the microcontroller can be used together with a typical RS232 SUB-D9 connector and a serial/USB converter
- The jumpers JP4 and JP5 routes the channel to the connector
- UART2 = USB-connector (X5), UART7\_R = Sub-D9 (X4) (default)
  - Setting of Jumper JP4 and JP5: U-2 / R-7R

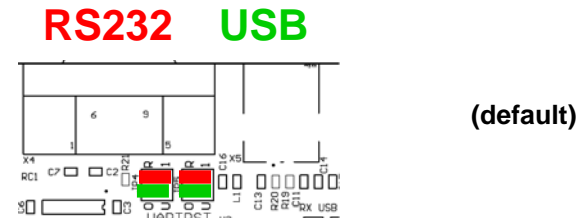

- UART2 = Sub-D9 (X4), UART7\_R = USB-connector (X5)
  - Setting of Jumper JP4 and JP5: U-7R / R-2

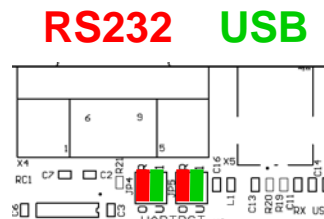



# The Hardware

## ■ The microcontroller pins

Pin	Pin-name	SK-16FX-48PMC
1	AVss	GND
2	AVRH	MCUVCC / VCC
3	P06_3 / AN3 / PPG3	SEG1-C
4	P06_4 / AN4 / PPG4	SEG1-D
5	P06_6 / AN6 / PPG6	SEG1-E
6	P06_7 / AN7 / PPG7	SEG1-F
7	P05_0 / AN8 / SIN2 / INT_3R1	UART2 (RXD)
8	P05_1 / AN9 / SOT2	UART2 (TXD)
9	P05_2 / AN10 / SCK2	
10	P05_4 / AN12 / TOT3 / INT2_R	
11	P05_6 / AN14 / INT4_R	Key button 'INT4_R'
12	P07_0 / AN16 / INT0 / NMI	
13	P04_0	
14	P04_1	
15	MD2	GND (w/ JP8 to VCC)
16	MD1	VCC
17	MD0	Mode-Switch S1

Pin	Pin-name	SK-16FX-48PMC
18	P00_0 / INT8 / SCK7_R / TTG8_R	Key button 'INT8'
19	P00_1 / INT9 / SOT7_R / TTG9_R	UART7_R (TXD)
20	P00_2 / INT10 / SIN7_R	UART7_R (RXD)
21	P00_4 / INT12 / SOT8_R / PPG8_R	
22	P00_5 / INT13 / SIN8_R / PPG9_R	
23	P00_3 / INT11 / SCK8_R	
24	P01_0 / CKOT1 / TIN1 / TTG16_R	
25	P01_1 / CKOTX1 / TOT1 / TTG17_R	
26	P01_4 / PPG16_R	SEG2-E
27	P01_5 / SIN2_R / INT7_R / PPG17_R	SEG2-F
28	P01_6 / SOT2_R / PPG18_R	SEG2-G
29	P01_7 / SCK2_R / PPG19_R	SEG2-DP
30	P02_0 / PPG12 / CKOT1_R	SEG2-A
31	P02_2 / PPG14 / CKOT0_R	SEG2-B
32	P02_4 / IN0 / TTG8 / TTG0	SEG2-C
33	RSTX	Key Button 'Reset'
34	X1	4 MHz Crystal

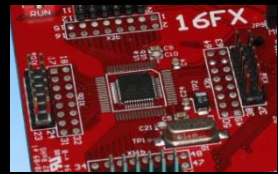

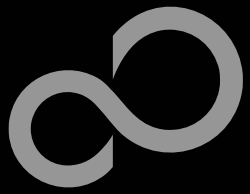

# The Hardware

## ■ The microcontroller pins (cont'd)

Pin	Pin-name	SK-16FX-48PMC
35	X0	4 MHz Crystal
36	Vss	GND
37	Vcc	MCUVCC / VCC
38	C	'C' Capacitors
39	P02_5 / IN1 / TTG1 / TTG9 / ADTG_R	SEG2-D
40	P03_0 / IN4 / TTG4 / TTG12 / TOT0_R	
41	P03_1 / IN5 / TOT2_R	
42	P03_2 / INT10_R / RX2	CAN2 (RX)
43	P03_3 / TX2	CAN2 (TX)
44	P03_6 / OUT6	SEG1-G
45	P03_7 / OUT7	SEG1-DP
46	P06_0 / AN0 / PPG0	SEG1-A
47	P06_1 / AN1 / PPG1	SEG1-B
48	AVcc	MCUVCC / VCC

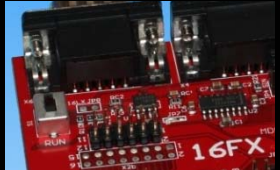
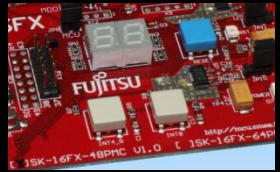

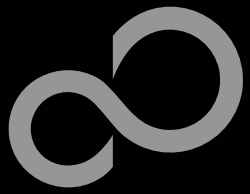

# The Software

- **The SK-16FX-48PMC CD includes the following software:**
  - Softune Workbench (development platform for Fujitsu microcontroller)
  - MCU Flash programming tool and SKwizard terminal program
  - USB driver for on board USB-to-RS232 converter
  - On-chip debugger “EUROScope lite 16FX“
  - Software examples for the SK-16FX-48PMC

- **Additionally you can order the latest „Fujitsu MICROS DVD“**
  - Includes documentation & software for all Fujitsu microcontrollers
  - Please contact your local [distributor](#)

- **Please check our dedicated microcontroller website**

**<http://mcu.emea.fujitsu.com>**

- for updates of the Flash programmer tool, utilities and examples
- for data sheets, hardware manuals, application notes, etc.

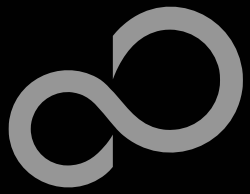

# Installation of the USB-driver

## ■ Connect the SK-16FX-48PMC to your PC's USB port

- Windows will 'Found New Hardware: SK-16FX-48PMC' and the Hardware Wizard should start automatically
  - **Note:** The installation procedure may differ with different operating systems

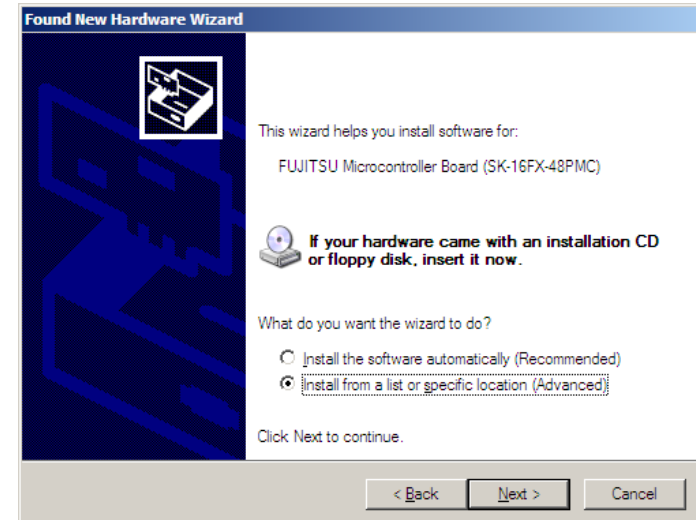

- Do not connect to Windows Update to search for software
- Select 'Install from a list or specific location (Advanced)'
- Within next windows select 'Search for the best driver' and browse on the CD to the folder 'drive:\USB-Driver\Win2000\_WinXP'



# Installation of the USB-driver

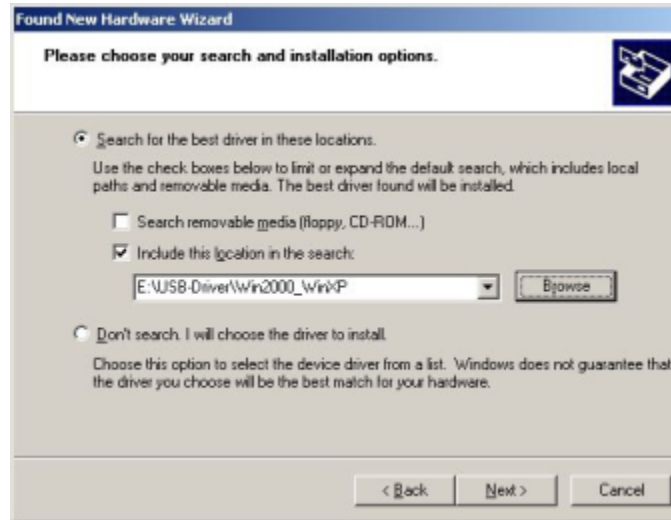

- 'Continue anyway' although the Windows Logo test may not be passed
- Windows completes the installation by copying some files
- 'Finish' will close the window





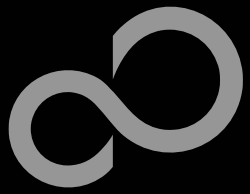

# Installation of the USB-driver

- Again Windows will 'Found New Hardware: USB Serial Port' and the Hardware Wizard should start automatically
  - **Note:** The installation procedure may differ with different operating systems

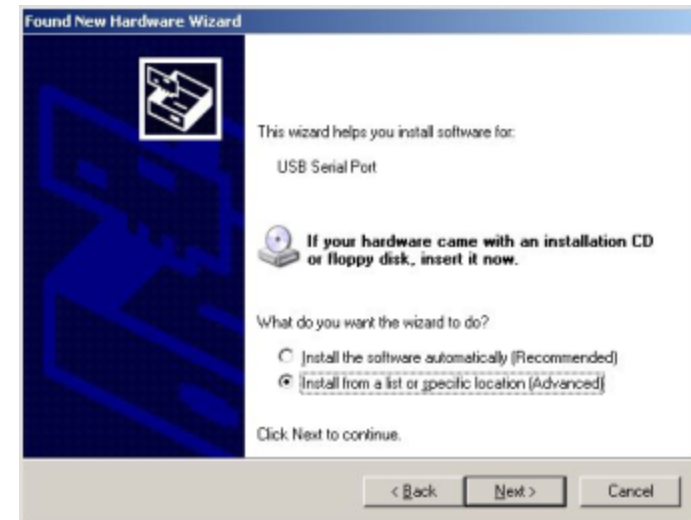

- Do not connect to Windows Update to search for software
- Select 'Install from a list or specific location (Advanced)'
- Within next windows select 'Search for the best driver' and browse on the CD to the folder 'drive:\USB-Driver\Win2000\_WinXP'

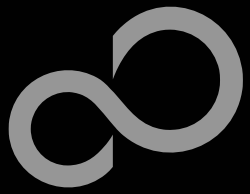

# Installation of the USB-driver

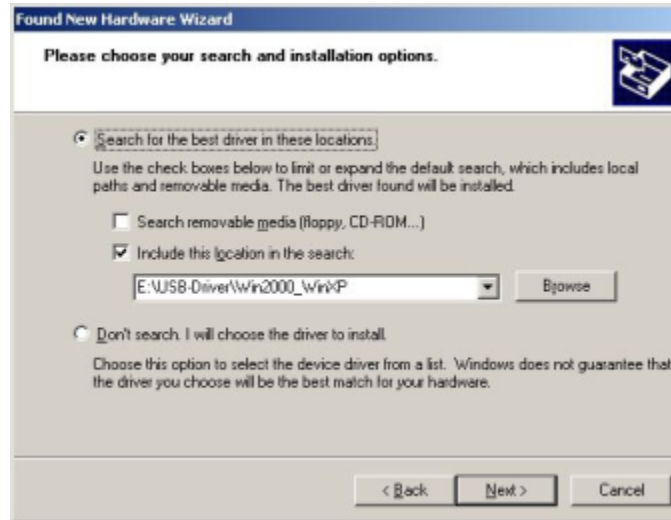
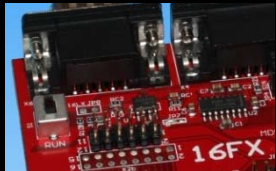

- 'Continue anyway' although the Windows Logo test may not be passed
- Windows completes the installation by copying some files



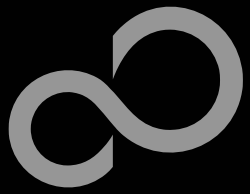

# Installation of the USB-driver

## ■ Start the Device Manager of the Windows Control Panel

- START -> Settings -> Control Panel
- Control Panel -> System -> Hardware -> Device Manager

## ■ Check 'Ports' for the assigned virtual COM-port number

- FUJITSU Microcontroller board (e.g.: COM4)

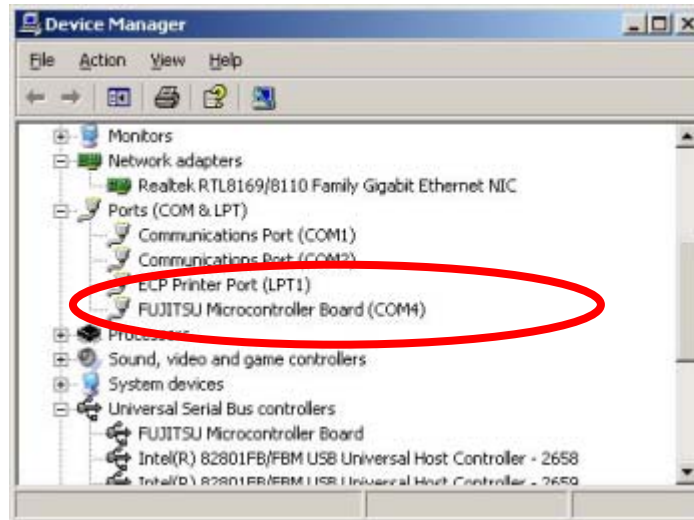

### Note:

Currently EUROScope supports only COM1 - COM9.

If the assigned virtual COM-port is greater than COM9 then please re-assign it manually by help of the device manager within the Windows control panel / system.

## ■ Ready!

- The SK-16FX-48PMC can be powered via USB (default, JP11)
- Depending on JP4 and JP5 one UART is connected to USB

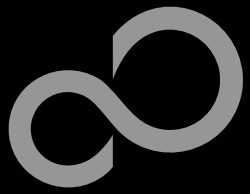

# The Development Software

## ■ Softune Workbench

- Free of charge (only registration is required)
- Windows based development platform for all 16-bit microcontrollers
- Includes: Editor, C-compiler, assembler, linker, core simulator
- Supports optional hardware emulator
- Requires 'administration' or 'power user' rights on the PC
- Registration\*
  - [https://mcu.emea.fujitsu.com/cusreg/htm/cusreg\\_form.htm](https://mcu.emea.fujitsu.com/cusreg/htm/cusreg_form.htm)
  - Receive your password for Softune Workbench by email
  - Receive your license file for EUROScope by email
- Start installation
  - Enter password and choose destination folder (e.g. c:\Softune16)

---

\*1 Note: If you want to use EUROScope please install and run it first and note down the Host ID (MAC address) of your PC system. This ID is needed to be filled out in the registration form to obtain a license key.

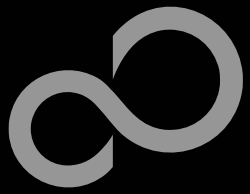

# The FLASH Programmer

## ■ MCU Flash programmer

- Free of charge, no registration required
- Windows based programming tool for all 16-bit Fujitsu microcontroller
- Uses PC serial port COMx (incl. virtual COM port: USB-to-RS232)
- [Start installation](#)

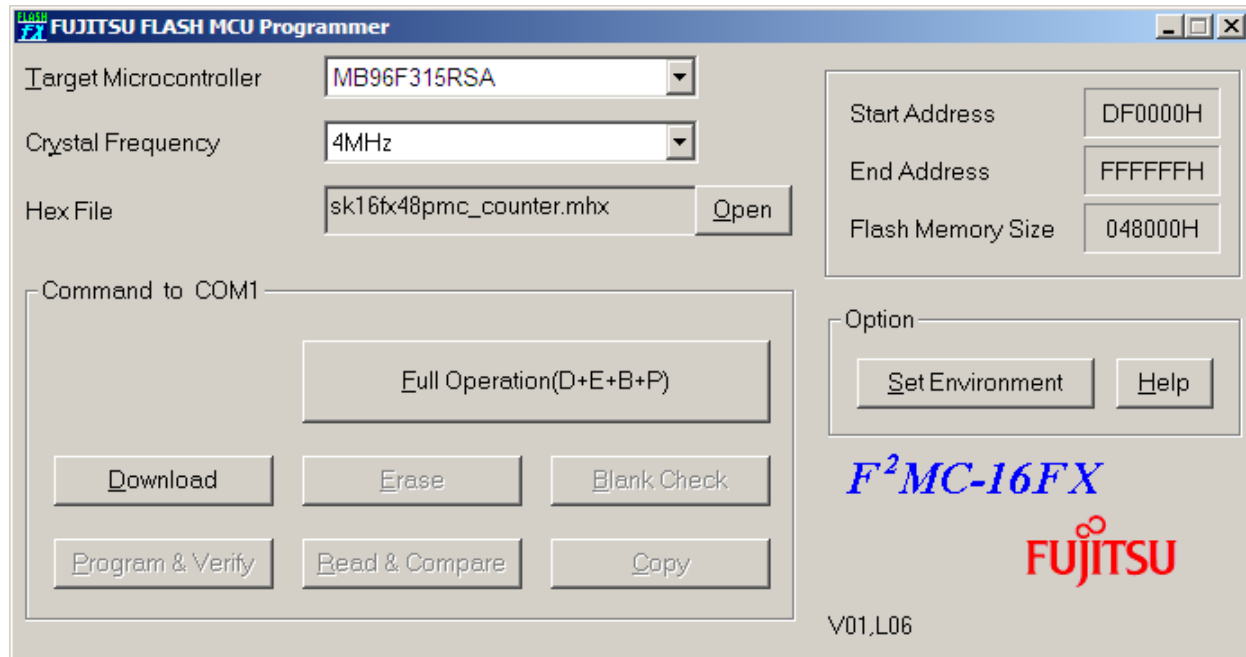

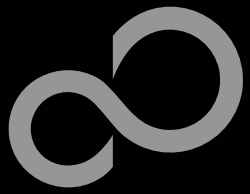

# Tools and Software Examples

## ■ SKwizard

- Free of charge terminal program
- [Start installation](#)

## ■ Following examples are provided with SK-16FX-48PMC:

- [sk16fx48pmc\\_adc\\_dvm](#)
  - Digital Voltage Meter based on the A/D-converter
- [sk16fx48pmc\\_can\\_uart\\_terminal](#)
  - Simple CAN example controlled by UART7\_R
- [sk16fx48pmc\\_counter](#)
  - Counts from 0 to 99 on the 7-segment Display
- [sk16fx48pmc\\_template](#)
  - ,Empty' project as base for user applications
- [sk16fx48pmc\\_uart](#)
  - UART example using UART7\_R
- [sk16fx48pmc\\_uart\\_7seg](#)
  - Displays UART Characters on the 7-segment Display

### Note:

Do not connect other than [EUROScope](#) to UART2 (default: X5/USB).

All examples are prepared to be used with EUROScope and UART2 is reserved for this debugger.

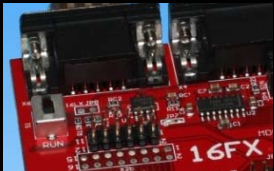

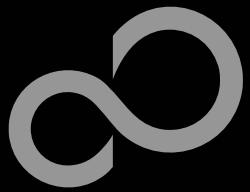

# Program Download

- Start the Fujitsu MCU Flash programmer
- Select the target microcontroller (MB96F315RSA)
- Select the crystal frequency (4 MHz)
- Choose the software example from the example 'ABS'-folder (e.g. D:\Examples\sk16fx48pmc\_counter-v10\ABS\sk16fx48pmc\_counter.mhx)

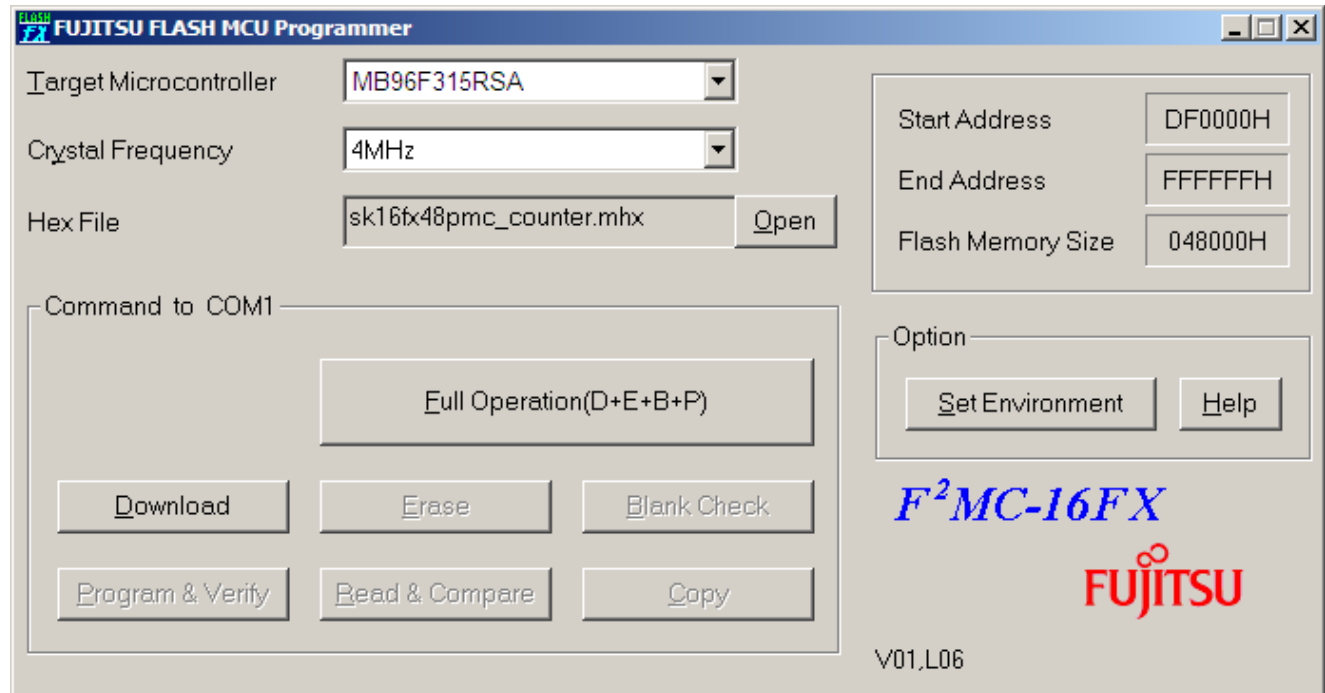
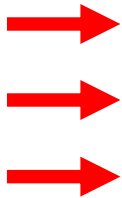



# Program Download

- **Connect to the PC**
  - RS232 or USB can be used
  - Select COM port (,Set Environment')
- **Set jumper S1 to position ,Prog'**
- **Press ,Reset'**
- **Start ,Full operation'**

**RS232 USB port**  
(see chapter Jumper settings)

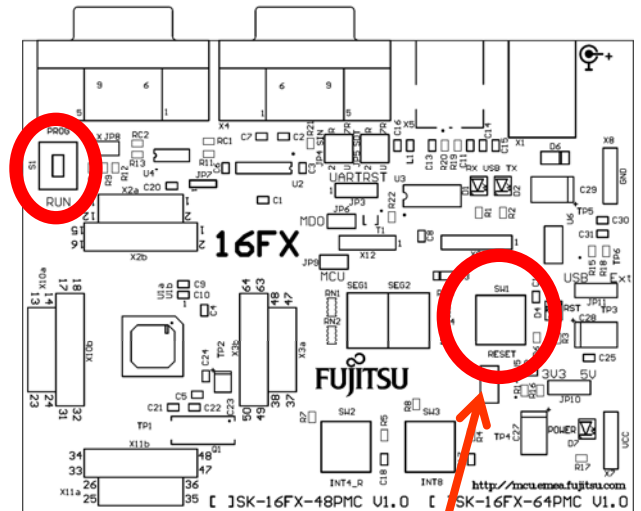

**S1: Mode selection**

**Prog: Set switch to position ,Prog' in order to select the program-mode**

**Keybutton ,RESET'**

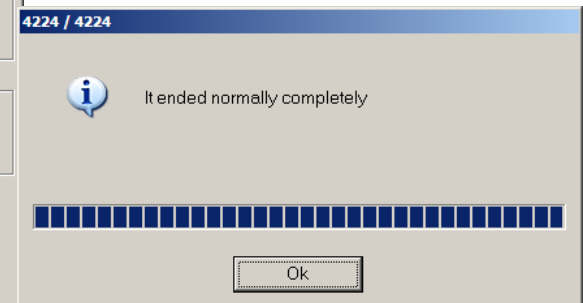
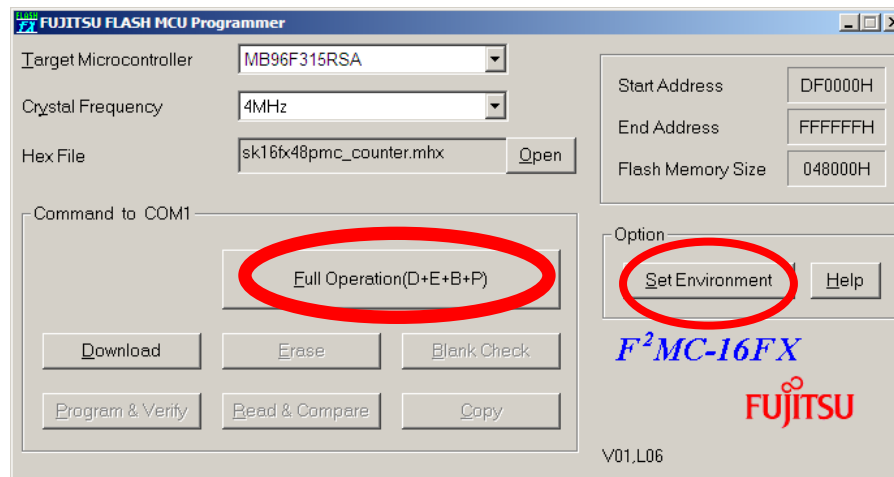



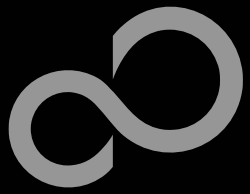

# Program Download

- Close the MCU Flash programmer
- Set jumper S1 to position ,RUN‘
- Press ,Reset‘



USB port

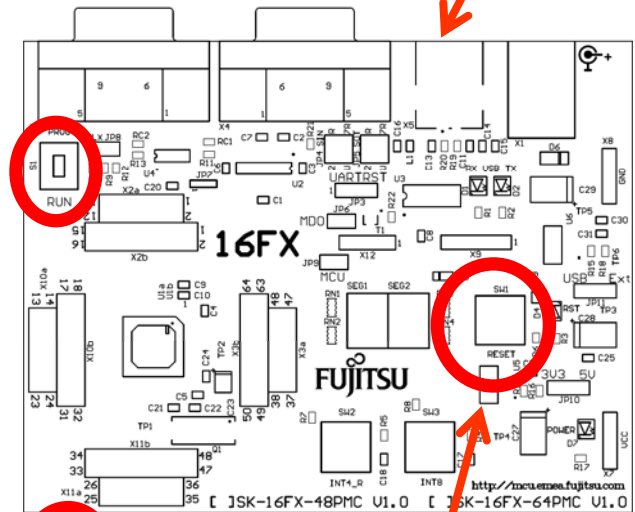

S1: Mode selection

Prog: Set switch to position ,RUN‘ in order to select the RUN-mode

Keybutton ,RESET‘

Close the Flash programmer

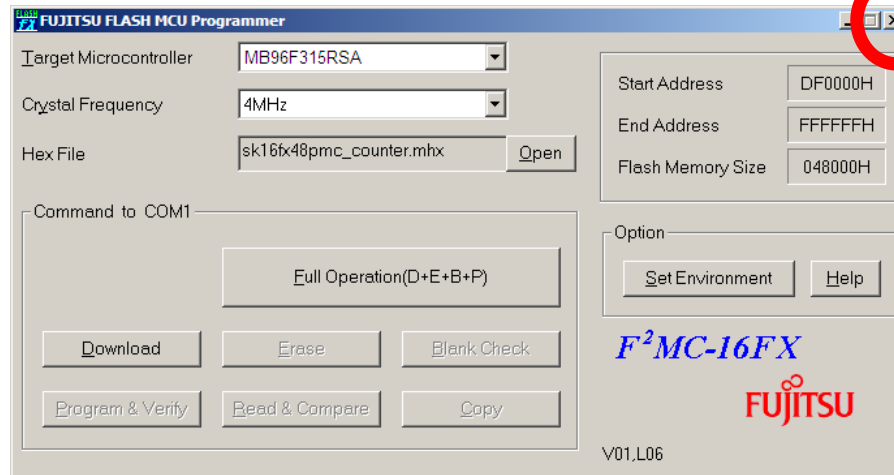

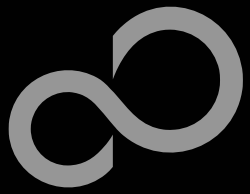

# New Project

- In order to start a new user project use the template project
  - This project includes the startup code, header files, and vector table
- Copy the folder 'Template' within the example folder
  - Rename 'Copy of sk16fx48pmc\_template-v10' to 'my\_application'

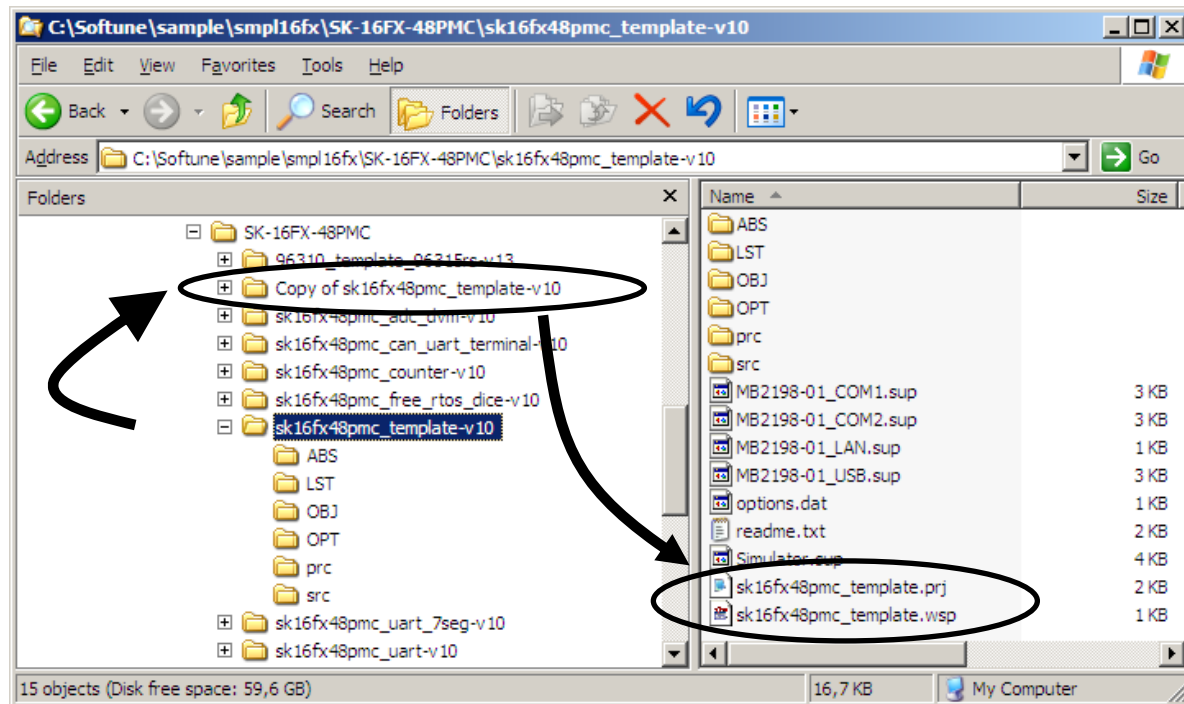

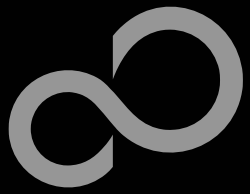

# New Project

## ■ Enter 'my\_application'-folder

- Rename 'template.prj' into 'my\_application.prj'
- Rename 'template.wsp' into 'my\_application.wsp'

## ■ Edit 'my\_application.prj'

- rename 'sk16fx48pmc\_template' -> 'my\_application'

## ■ Edit 'my\_application.wsp'

- rename 'sk16fx48pmc\_template' -> 'my\_application'

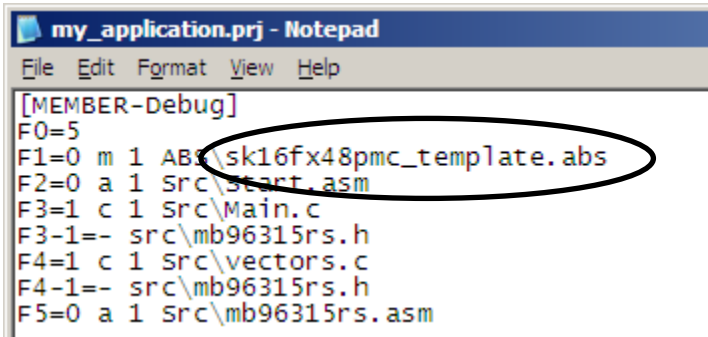

```
File Edit Format View Help
[MEMBER-Debug]
F0=5
F1=0 m 1 ABS\sk16fx48pmc_template.abs
F2=0 a 1 Src\start.asm
F3=1 c 1 Src\Main.c
F3-1-- src\mb96315rs.h
F4=1 c 1 Src\vectors.c
F4-1-- src\mb96315rs.h
F5=0 a 1 Src\mb96315rs.asm
```

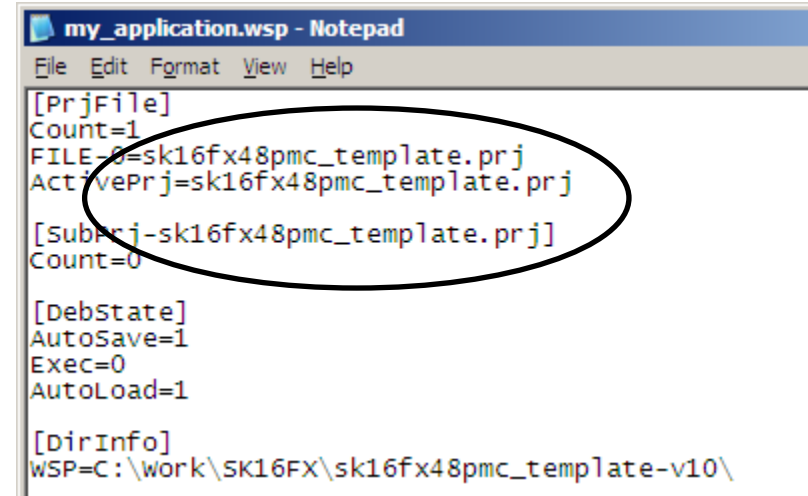

```
my_application.wsp - Notepad
File Edit Format View Help
[PrjFile]
Count=1
FILE=sk16fx48pmc_template.prj
ActivePrj=sk16fx48pmc_template.prj
[SubPrj-sk16fx48pmc_template.prj]
Count=0
[Debstate]
AutoSave=1
Exec=0
AutoLoad=1
[DirInfo]
WSP=C:\work\SK16FX\sk16fx48pmc_template-v10\
```



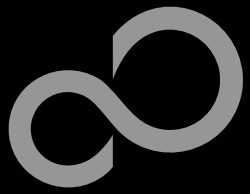

# New Project

- Start Softune Workbench and open your project

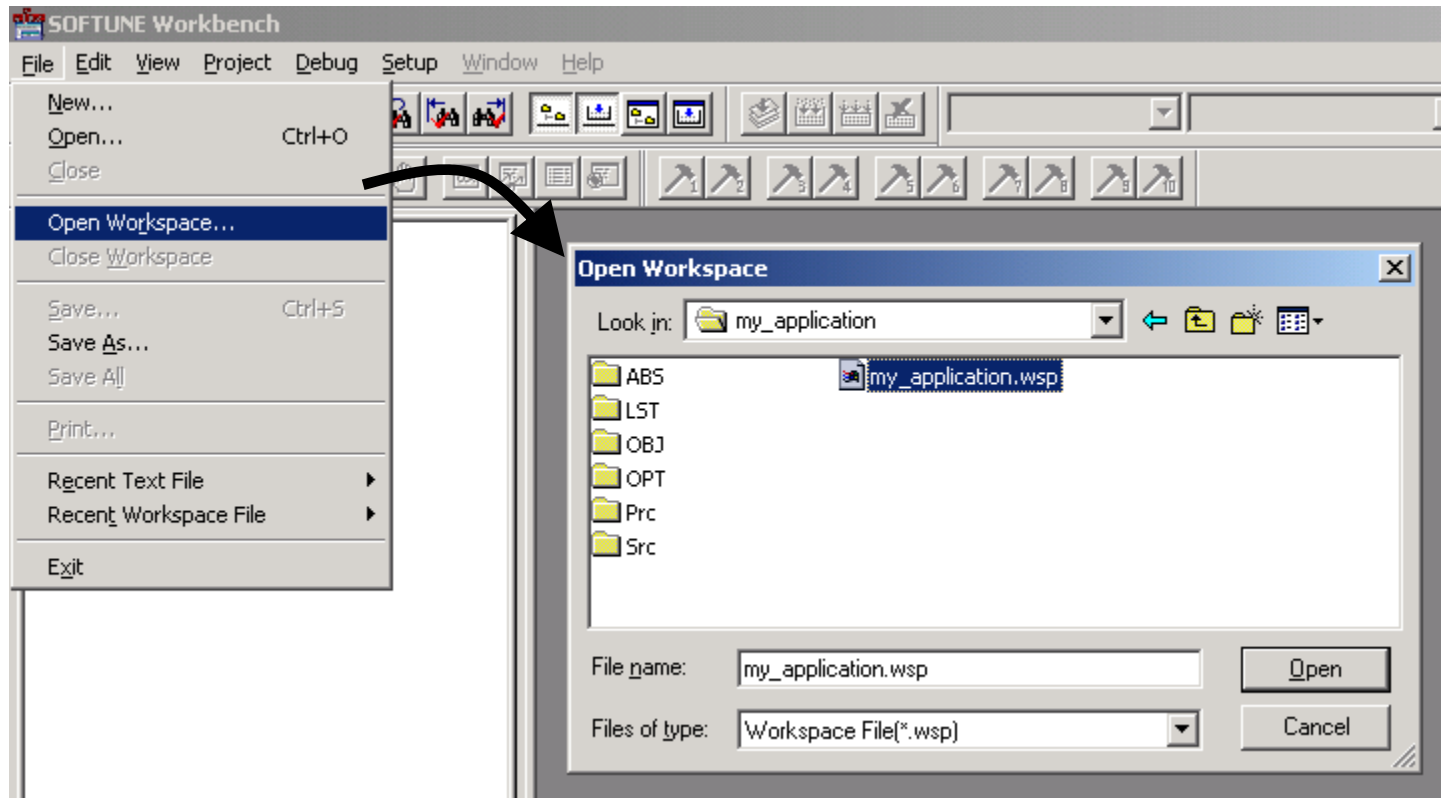
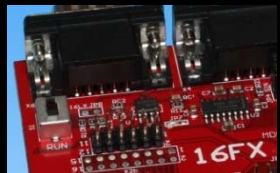

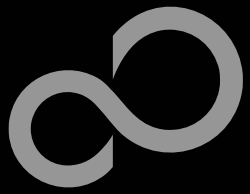

# New Project

## ■ Write your application code

- Start.asm : Startup code
- Vectors.c : Vector table
- Main.c : Your application

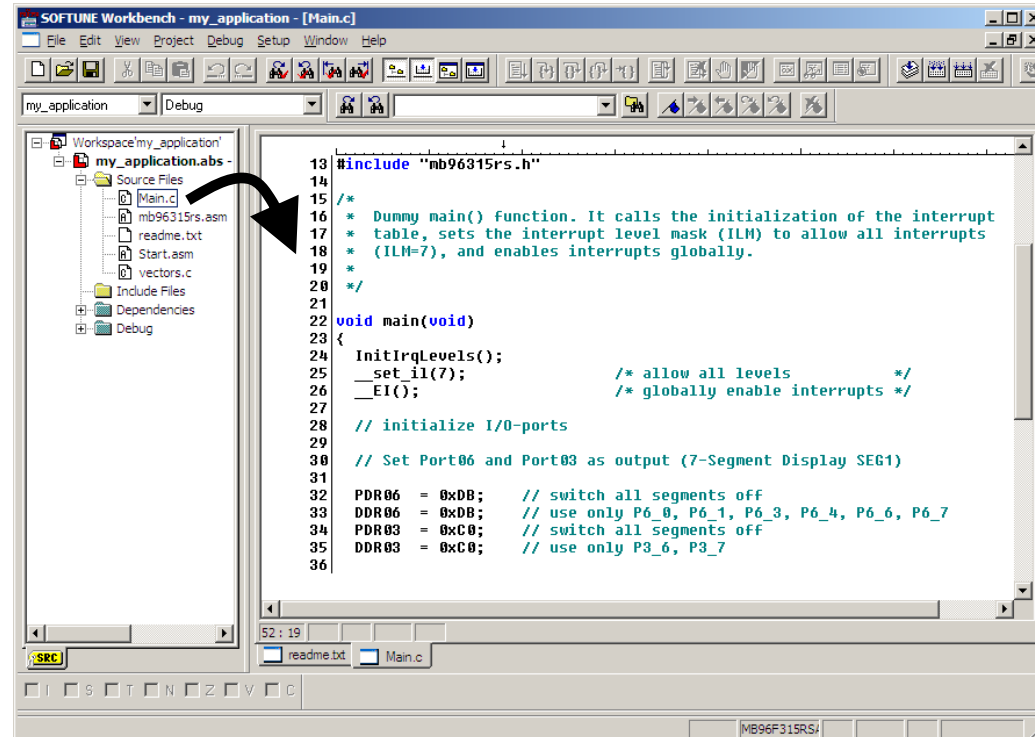

```
13 #include "mb96315rs.h"
14
15 /*
16  * Dummy main() function. It calls the initialization of the interrupt
17  * table, sets the interrupt level mask (ILM) to allow all interrupts
18  * (ILM=7), and enables interrupts globally.
19  */
20 */
21
22 void main(void)
23 {
24     InitIrqLevels();
25     _set_il(7);           /* allow all levels */
26     __EI();              /* globally enable interrupts */
27
28     // initialize I/O-ports
29
30     // Set Port06 and Port03 as output (7-Segment Display SEG1)
31
32     PDR06 = 0xDB;       // switch all segments off
33     DDR06 = 0xDB;       // use only P6_0, P6_1, P6_3, P6_4, P6_6, P6_7
34     PDR03 = 0xC0;       // switch all segments off
35     DDR03 = 0xC0;       // use only P3_6, P3_7
36 }
```

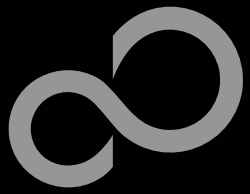

# New Project

## ■ Compile and build your project

- Generates the MHX-file, which can be programmed to the Flash

Compile Make Build

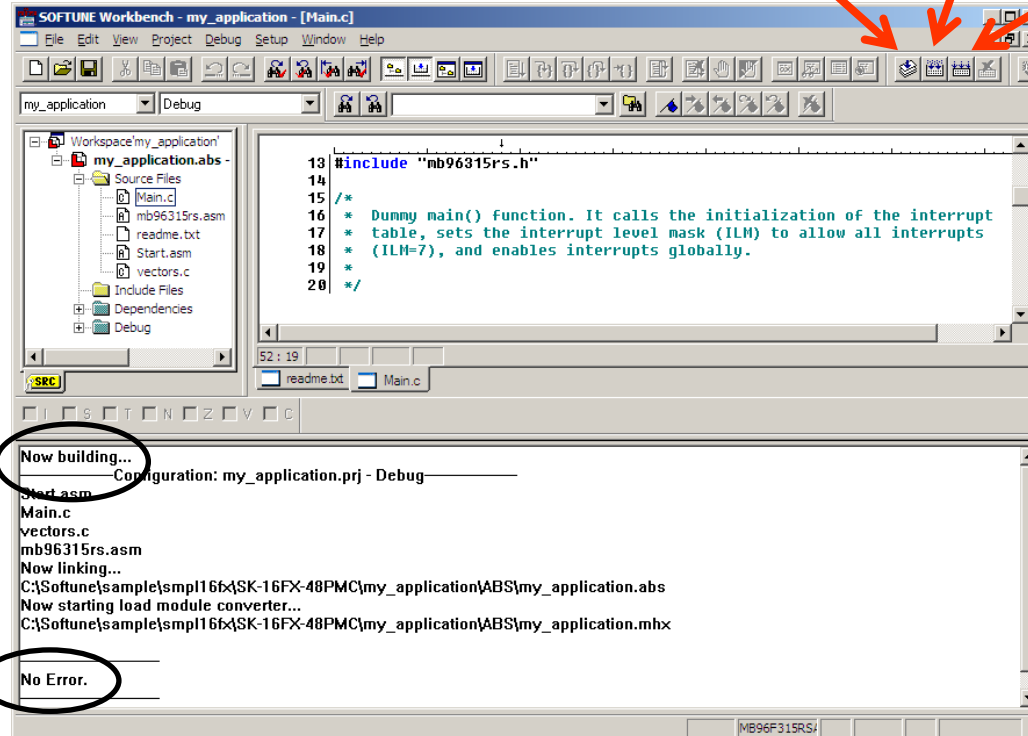

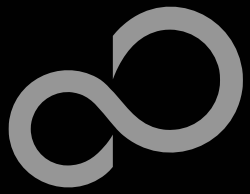

# New Project

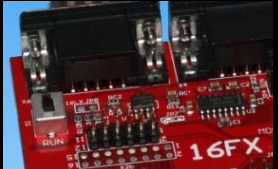
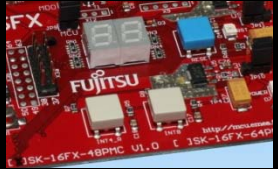

**Congratulations!**

■ You have finished your first project

- Please see our application note [‘16FX Getting Started’](#) for a more detailed introduction.



# EUROScope lite 16FX

## ■ „EUROScope lite 16FX“ source-level debugger

- On-chip debugging for 16FX microcontroller
- No kernel linkage / upload required
- Breakpoints
- Single step debugging (step, step-in, step-out)
- Windows for memory, watch, mixed source code, register
- Plug-ins available for operating systems etc.

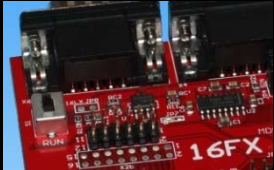



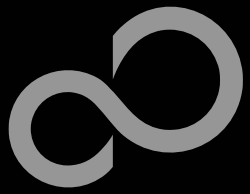

# EUROScope lite 16FX Installation

## ■ Installation of „EUROScope lite 16FX“

- Start „EUROScope lite 16FX“ for installation
- Choose „Fujitsu F16LX / F16FX“ from list

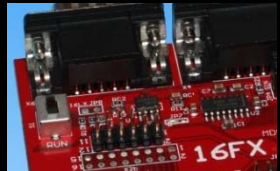
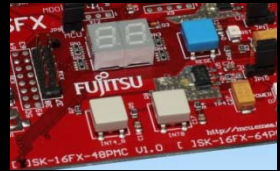
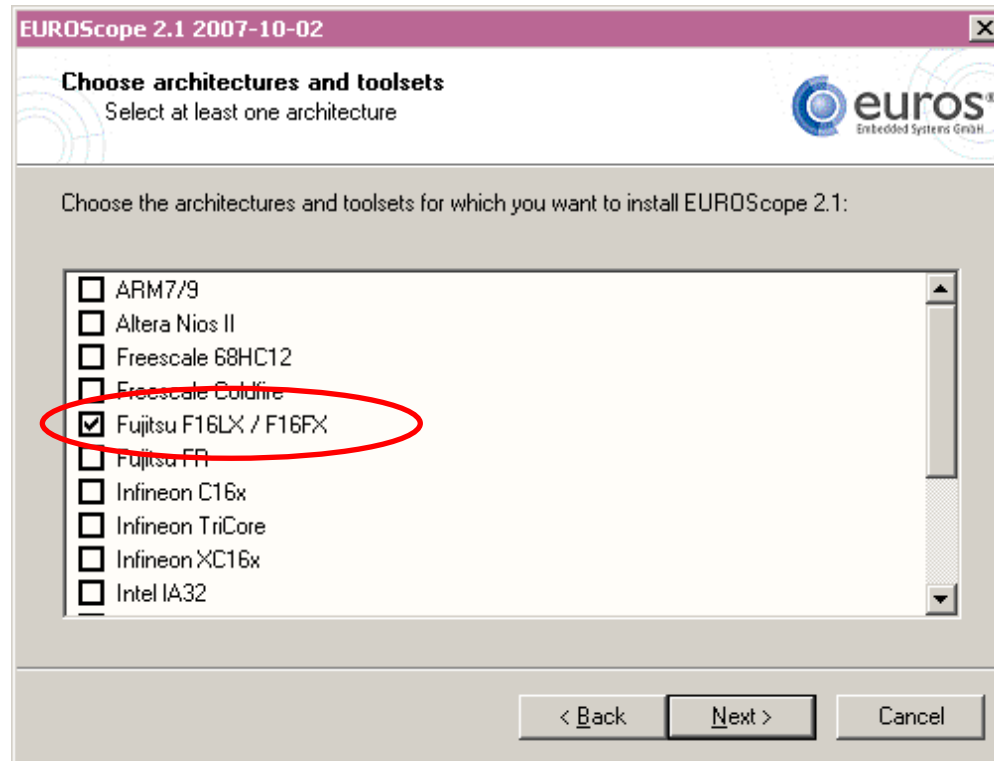

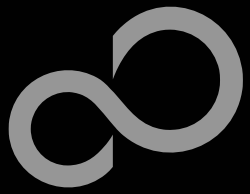

# EUROScope lite 16FX Installation

## ■ License for „EUROScope lite 16FX“

- Run EUROScope.exe
  - Copy Host ID (MAC address) of your PC system
  - Request Lite key at [https://mcu.emea.fujitsu.com/cusreg/htm/cusreg\\_form.htm](https://mcu.emea.fujitsu.com/cusreg/htm/cusreg_form.htm)
  - Receive license key file from company EUROS by email
  - Copy license key file (*euros-license.key*) to your local installation path

Host ID of  
your PC  
system

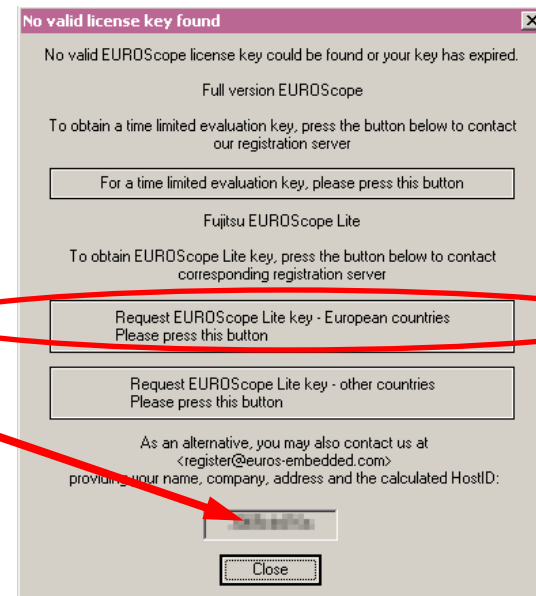

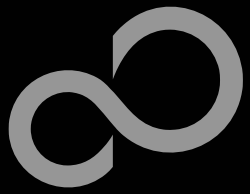

# EUROScope lite 16FX Project preparation

- All examples within this package are already prepared for the use with EUROScope

- Default connection: UART2 routed to X5/USB.

- In case of new projects or project modifications

- Use Softune Workbench
- Setup the Background Debugging area
  - See *Start.asm* (v1.28), chapter 4.18 (Enable Background Debugging Mode) and chapter 5.9 (Debug Address Specification)
    - See always the latest 'sk16fx48pmc\_template' example
- Built your application project with Softune Workbench
  - Loadmodule (\*.abs) format is required for debugging

- Download your project (\*.mhx) to the board

- Use the Fujitsu MCU Flash programmer

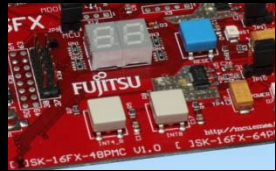

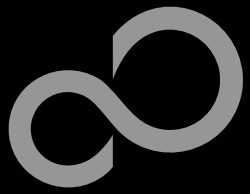

# EUROScope lite 16FX Configuration

## ■ Start EUROScope

## ■ Ensure the following settings

- Select Target Connection ①
  - Choose Fujitsu 16FXBootROM (RS232)
- Configure Target Connection ②
  - Choose the COM port of the Debug-UART (Default: UART2 routed to X5/USB)
  - Choose the baudrate used in the Debug Address Specification of the *Start.asm* file (Default: 115200)
  - Choose „asynchronous communication“ and „Int/Ext vector mode“

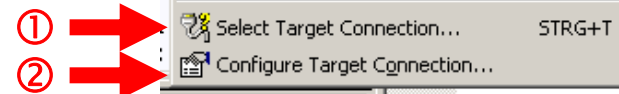
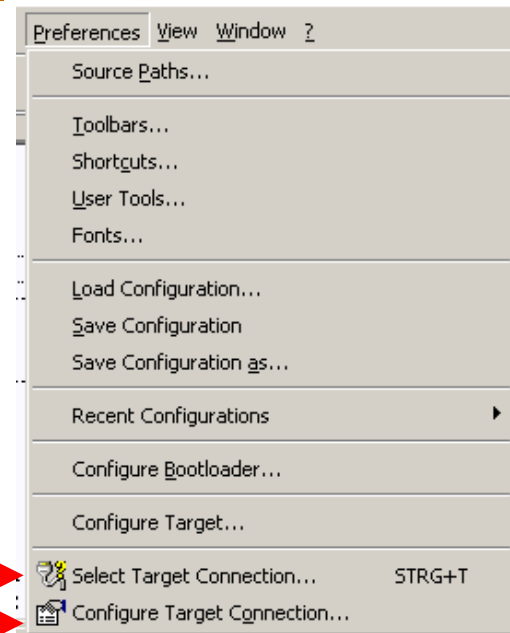

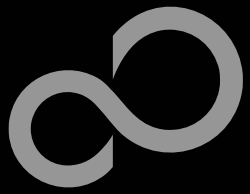

# EUROScope lite 16FX

## Load ABS file

### ■ Load the *abs* file of your project

- File / Open Application ...

E.g.: <drive>:\Examples\sk16fx48pmc\_counter-v10\ABS\sk16fx48pmc\_counter.abs

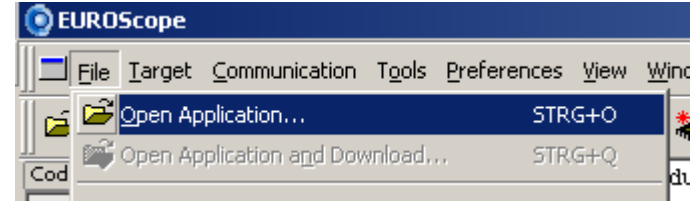

### ■ Projects may be compiled on another PC or folder structure than the debug PC

- Adjust the source path ①
  - Click New (Insert) ②
  - Browse to source folder ③
  - E.g.: <drive>:\Examples\sk16fx48pmc\_counter-v10\Src

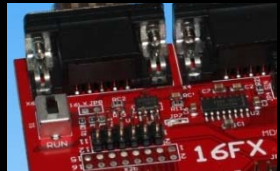
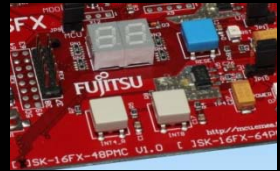
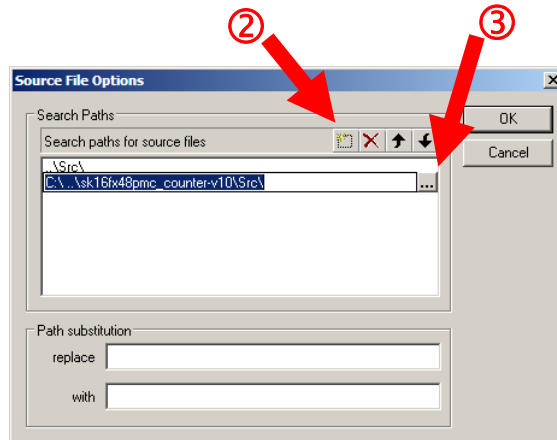
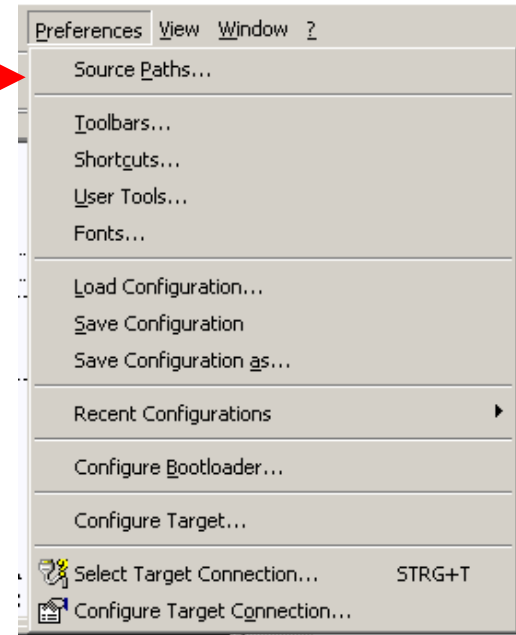



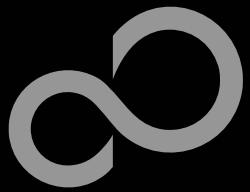

# EUROScope lite 16FX

## Start Debugging

- Initialize target and run until main function



- Use menu bar for debugging

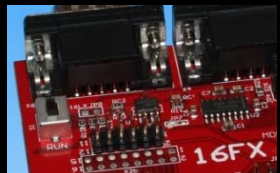
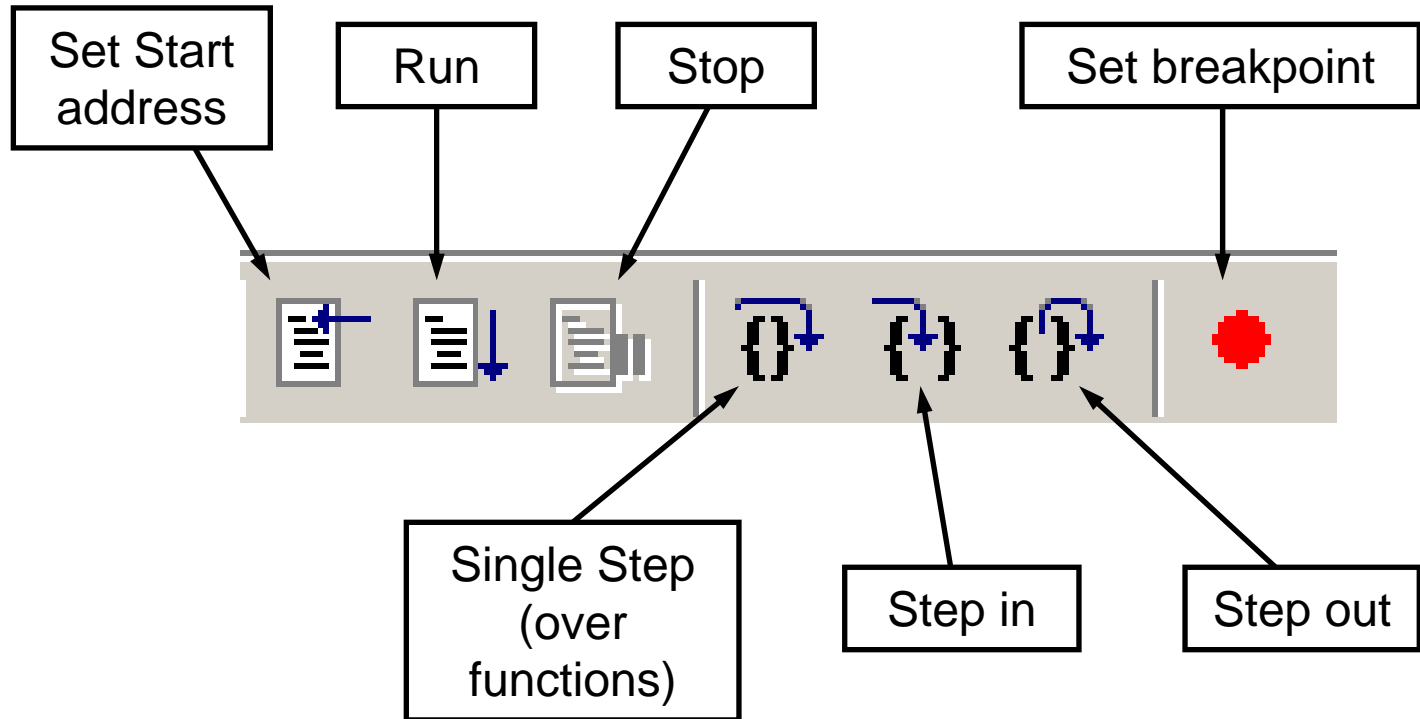



# EUROScope lite 16FX Breakpoints

## ■ Set a breakpoint

- Double-click to desired line
  - ,C' code source: selectable lines are marked by small dot in front
  - ,Assembly' window: all lines with an instruction can hold a breakpoint
  - Some lines in source code window are grouped. When setting a breakpoint all grouped lines getting the red filled circle, but this is treated as only one breakpoint

## ■ Activate/deactivate breakpoints

- Single-click to breakpoint

## ■ Delete breakpoint

- Double-click to breakpoint until red filled (or white filled) circle disappears

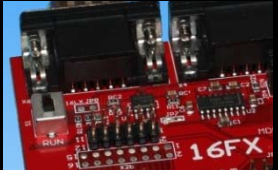
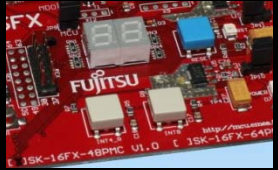



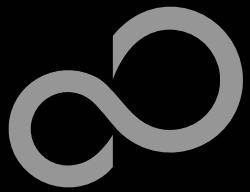

# EUROScope lite 16FX Breakpoints

## ■ Short explanation of EUROScope source code window

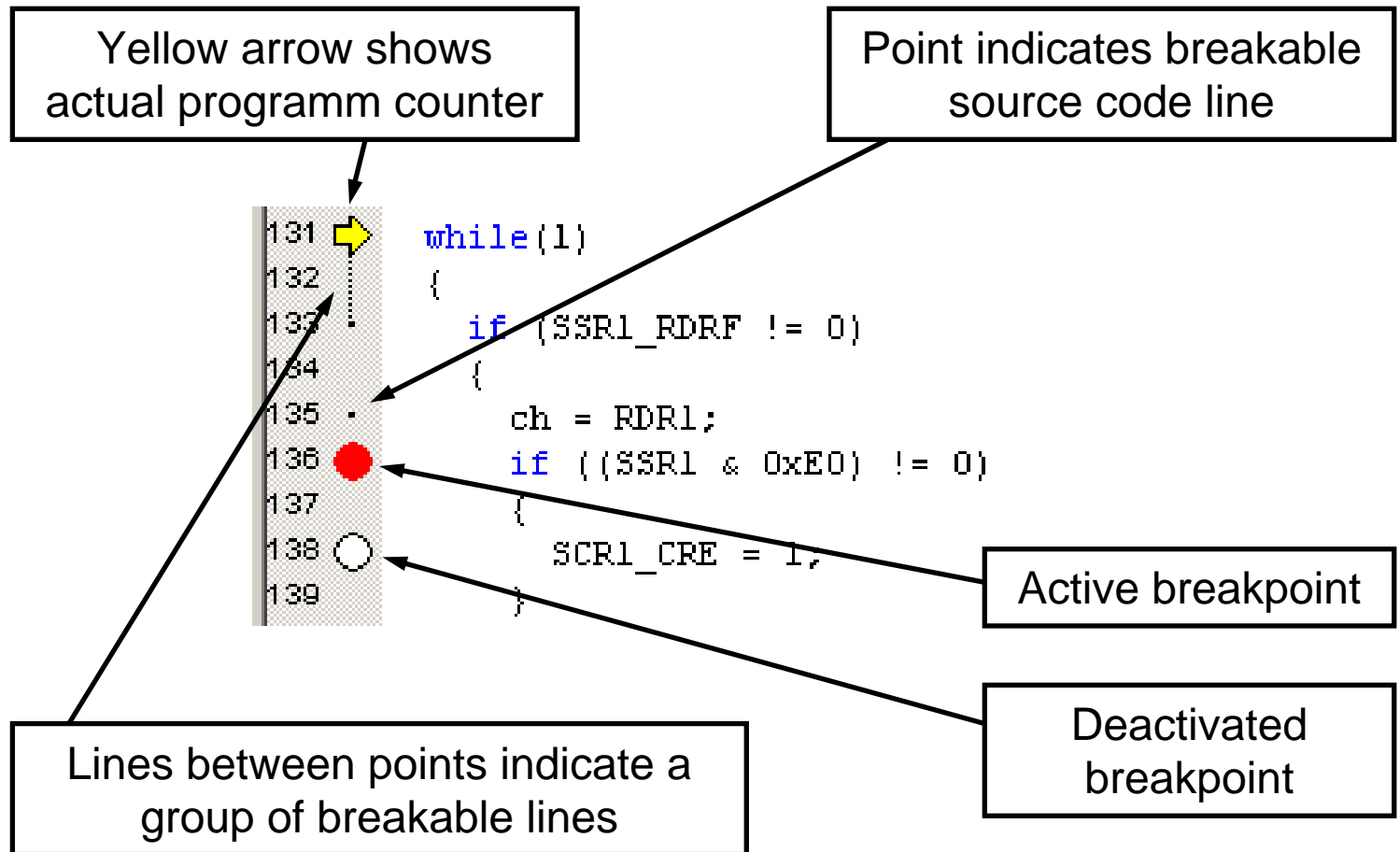

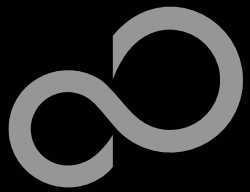

# EUROScope lite 16FX Processor Status

- Processor window provides most important registers
- All processor flags are shown individually
- All values can be changed
- Window is updated on any stop or break of the application
- Changes in values are displayed in red due to prior update

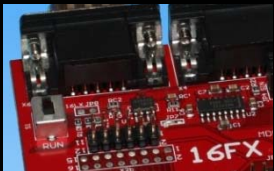
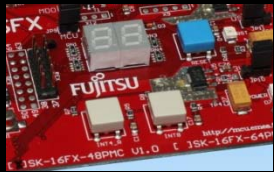

```
Register: unknown register
RL0=01CC0000  RL1=00F80004  RL2=00020000
RL3=00F80000
RW0=0000  RW1=01CC  RW2=0004  RW3=00F8
RW4=0000  RW5=0002  RW6=0000  RW7=00F8
R0=00  R1=00  R2=02  R3=00  R4=00  R5=00
R6=F8  R7=00
A=00660066  AH=0066  AL=0066
PC=F80169  SSP=00253E  USP=002544
DPR=22  DTB=00  ADB=00
PS=EOE5  ILM=7  RP=00  CCR=E5
I=1  S=1  T=0  N=0  Z=1  V=0  C=1  TBR=0000
```

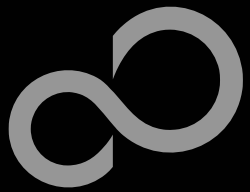

# EUROScope lite 16FX Variable Window

## ■ Local

- Local variables are automatically collected in view „Local“

## ■ Watch

- All local and up to 8 global variables can be added individually to the 'Watch' window

## ■ Variables are updated on any stop or break of the application

## ■ Changed values are displayed in red

## ■ Variable values can be changed in 'value' entry

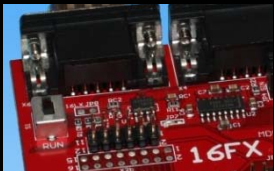
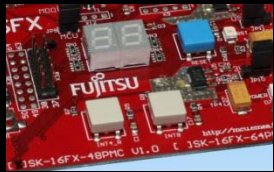

Variable	Value	Type	Storage	Module	Address	Size
cnt1	22	char	0x2246	main	0x2246	1 byte
cnt2	9	char	0x2245	main	0x2245	1 byte
cntdir	0	char	0x2244	main	0x2244	1 byte
delay	40144	unsigned long	0x2240	main	0x2240	4 byte

Local Global **Watch** this

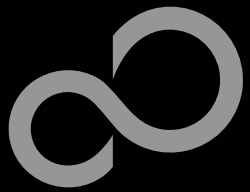

# EUROScope lite 16FX Memory View

- Memory view is updated on every stop or break
- Value change is displayed in red due to prior update
- Memory content can be changed
- Memory can be filled with a user byte and size

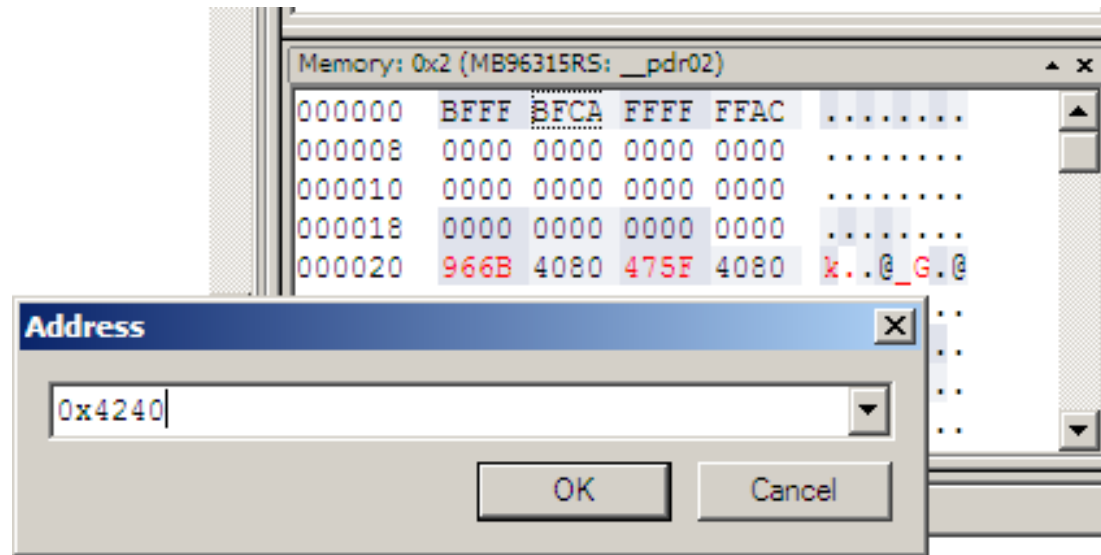
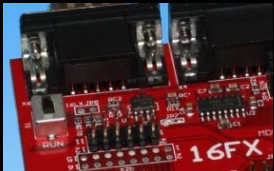

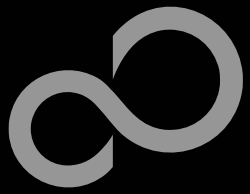

# EUROScope lite 16FX

## Changing/Adding Source Window

### ■ New source module window

- Go in window tab area and right-button click
- Choose „New Source window“

### ■ Change source window

- Get menu by right-mouse-button-click in the source window
- Choose „Show Module...“
- Browse to Module File

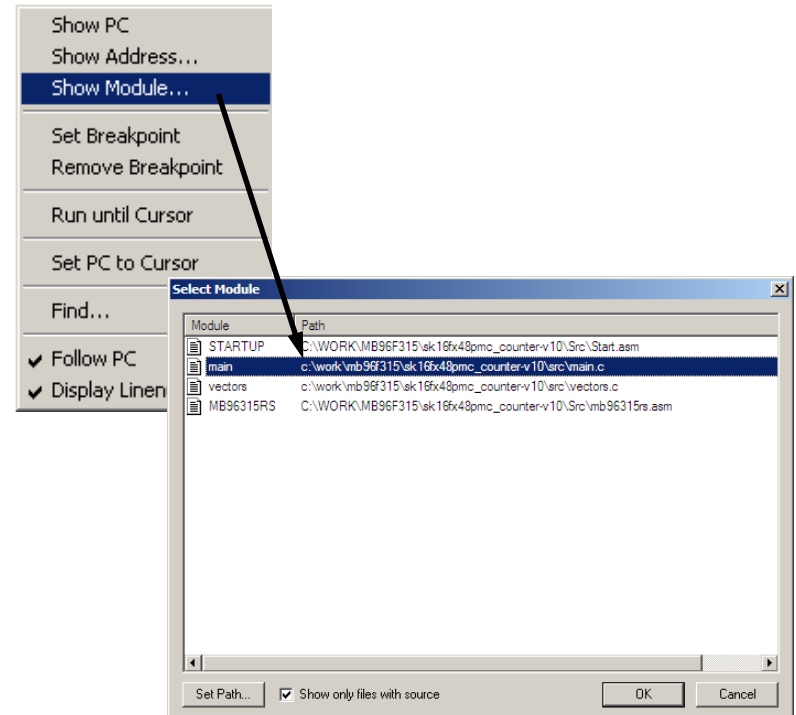
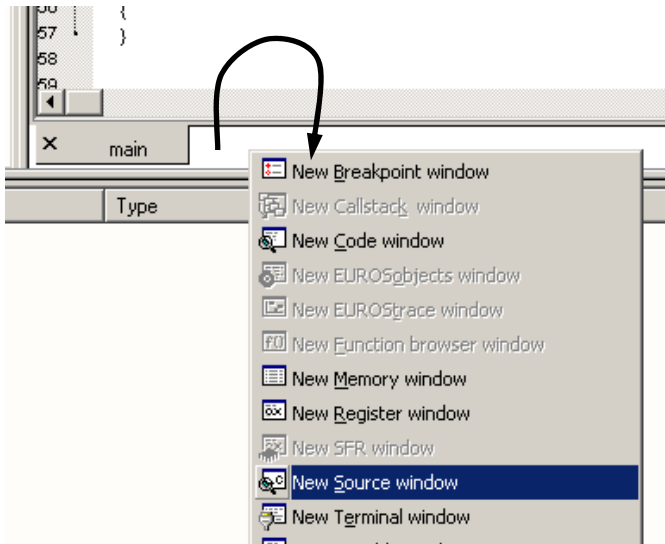

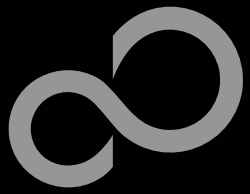

# EUROScope lite 16FX Flash Programming

## ■ Flash programming is available via the Flash button:

- BDM configuration can be set before programming
- Chip erase is supported
- Flash programming is supported
- User has to press reset button after Flash programming
- Fujitsu Flash programming kernels are reused

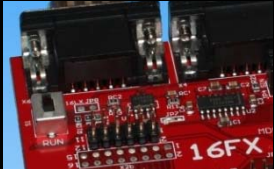
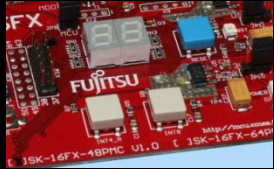

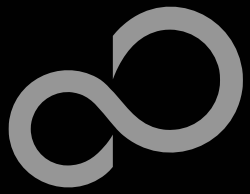

# EUROScope lite 16FX BDM Configuration

- Background debugging mode configuration
- Flash security unlock



**Flash and BootROM configuration**

Flash security

Main: Flash UNLOCKED

Satellite: Flash UNLOCKED

Main key:

Sat. key:

CAUTION: The FULL ZERO key hides the ROM/Flash from any analysis. Since the ROM/Flash cannot be released with secret key, FUJITSU cannot analyze contents in case of failure.

BDM configuration

BDM Activation marker

BDM configuration marker

UCS:  Mode:

Automatic start (on = enabled)

External breakpoint configuration

Keep RC-Clock

Calibrate USART baud rate

BDM Watchdog pattern (hex):

Debug baud rate

Clock:  Baud:

Enable USART Scan

FBVAM (checked = (DF0080'H) in mode 3)

Do not show again

Flash security unlock keys

BDM Activation

[✓] Use EUROScope configuration

[ ] Use MHX file configuration

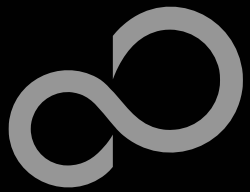

# EUROScope lite 16FX Flash Programming Dialog

## ■ Chip erase and Flash programming

- Click on ,Done' and reset board after programming

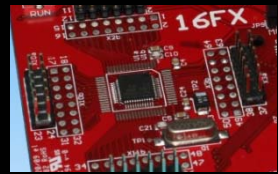

**Flash Programming**

Chip	Address Range	Size	Description
Flash 0	00DF0000h .. 00DF7FFFh	32 KB	Unknown (430000ee) internal flash (int)
Flash 1	00F80000h .. 00FFFFFFh	512 KB	Unknown (430000ee) internal flash (ma)

Sectors	Address Range	Size
Flash 1 Sector 0	00F80000h .. 00F8FFFFh	64 KB
Flash 1 Sector 1	00F90000h .. 00F9FFFFh	64 KB
Flash 1 Sector 2	00FA0000h .. 00FAFFFFh	64 KB
Flash 1 Sector 3	00FB0000h .. 00FBFFFFh	64 KB
Flash 1 Sector 4	00FC0000h .. 00FCFFFFh	64 KB
Flash 1 Sector 5	00FD0000h .. 00FDFFFFh	64 KB
Flash 1 Sector 6	00FE0000h .. 00FEFFFFh	64 KB
Flash 1 Sector 7	00FF0000h .. 00FFFFFFh	64 KB

File: C:\WORK\MB96F315\sk16fx48pmc\_counter-v10\ABS\sk16fx48pmc\_counter.m

Use this base address: 0x0  Auto load when programmed

Fill gaps up to 0 bytes with 0xFF  Reconfigure when programmed

Status: \_\_\_\_\_

Progress: \_\_\_\_\_

Info: 10 sections from 0xDF0000 to 0xFFFFDE  
1: 0xDF0000..0xDF0001  
2: 0xDF001C..0xDF001F  
3: 0xDF0030..0xDF0037  
4: 0xDF0040..0xDF004B

Buttons: Erase, Program, Done

Chip erase  
(,all sectors' must be checked)

Browse to MHX file

Flash programming



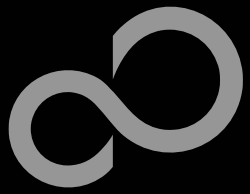

# EUROScope lite 16FX Prospect

## ■ All SK-16FX-48PMC examples are configured as follows:

- UART2 for debugging
- UART7\_R may be used by the application
- Asynchronous communication
- 115200 Bits/s
- Autorun after reset
- No breakpoint predefinition

## ■ For more details of „EUROScope lite 16FX“ please refer to application note:

- [mcu-an-300235-e-16fx\\_using\\_EUROScope](#)

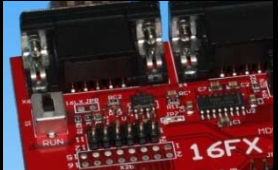
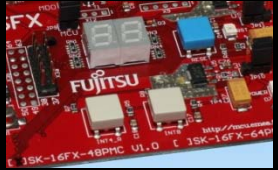

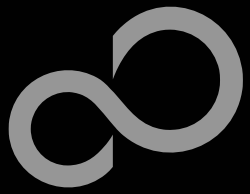

# FreeRTOS™

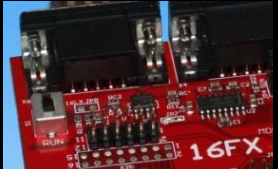
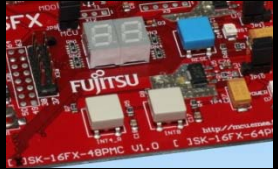

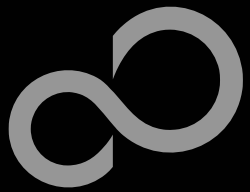

# FreeRTOS™



- The most widely used open source real-time operating system for embedded microcontrollers
- It has the performance, quality and stability of a commercial product
- It is available through a very liberal distribution and licensing model which allows users to obtain and develop software with almost no restrictions
- Optional commercially licensed and supported versions are available through WITTENSTEIN
- Features:
  - Designed specifically for microcontrollers
  - Powerful trace macros
  - Stack overflow protection
  - No restrictions on priority assignment
  - Safety certified version available – proving robustness
  - Tasks, co-routines, queues, binary semaphores, counting semaphores, recursive semaphores, mutexes, interrupt interaction primitives

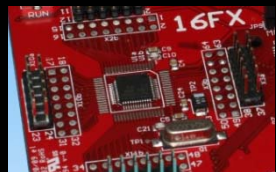
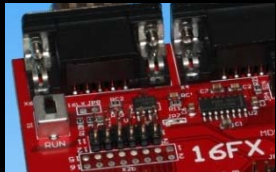

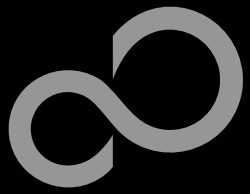

# FreeRTOS™ - Tasks



## ■ Autonomous

- No knowledge of scheduler activity
- A sequential process
- Running on a 'virtual processor'
- Prioritised

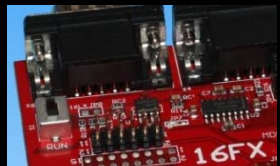
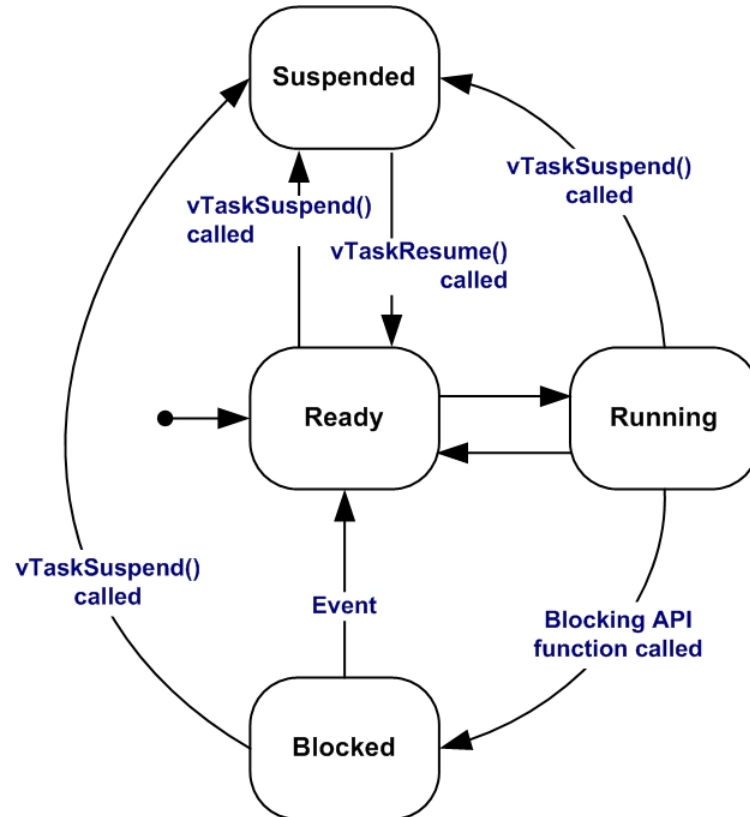

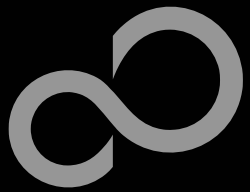

# FreeRTOS™ - Multitasking



## ■ Prioritised Pre-emptive Multitasking

```

void aTask( void * pvParameters )
{
    for( ;; )
    {
        /* Task processing goes here. */
    }
    vTaskDelete( NULL );
}

```

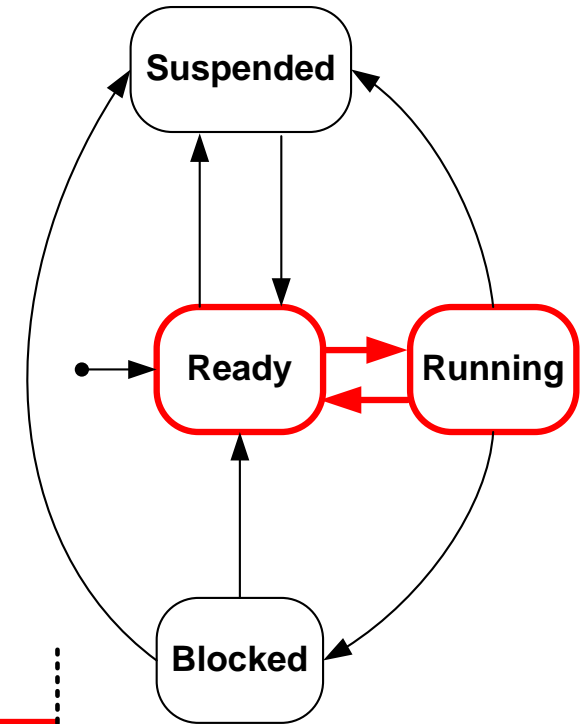

med, periodic

low, event

Idle task

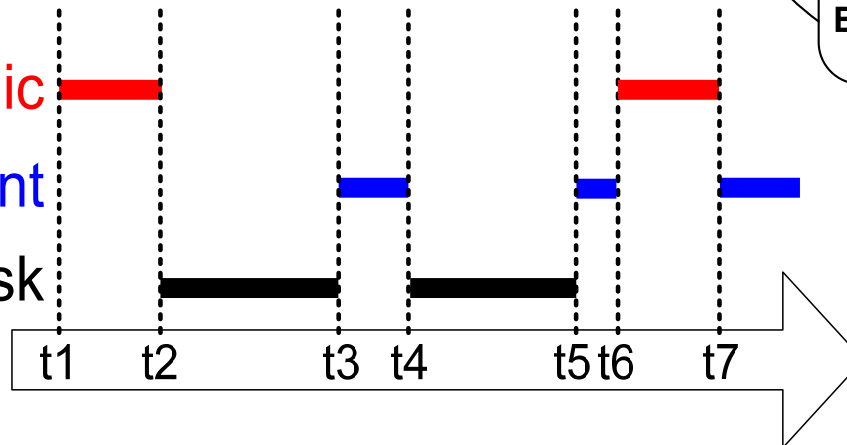

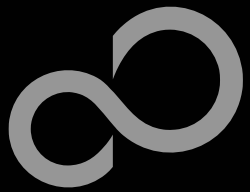

# FreeRTOS™ - Queues



- To be useful tasks must be able to communicate with each other

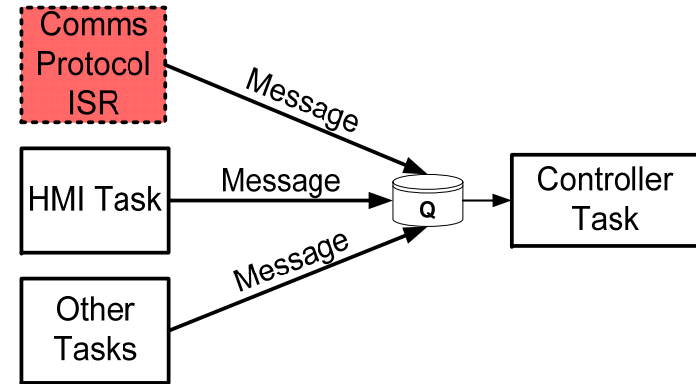

```
xQueueHandle xQueue; // Declare the queue
```

```
void vTask1( void *Param )
{
  char cValueToWrite = 10;
```

```
    xQueue = xQueueCreate( 10, sizeof( char ) ); // Create queue
```

```
    for( ;; ) {
        xQueueSendToBack( xQueue, &cValueToWrite, 10 );
    }
```

```
/*-----*/
```

```
void vTask2( void *Param )
{
  char cValueToReceive;
```

```
    for( ;; ) {
        xQueueReceive( xQueue, &cValueToReceive, 10 );
    }
```

```
}
```

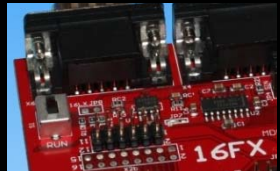
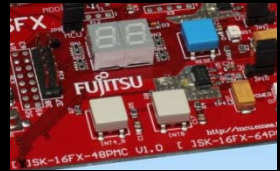





# FreeRTOS™ - Synchronisation

- Tasks provide a convenient mechanism for processing asynchronous events
- Semaphores can be used to implement “Deferred Interrupt Handling”

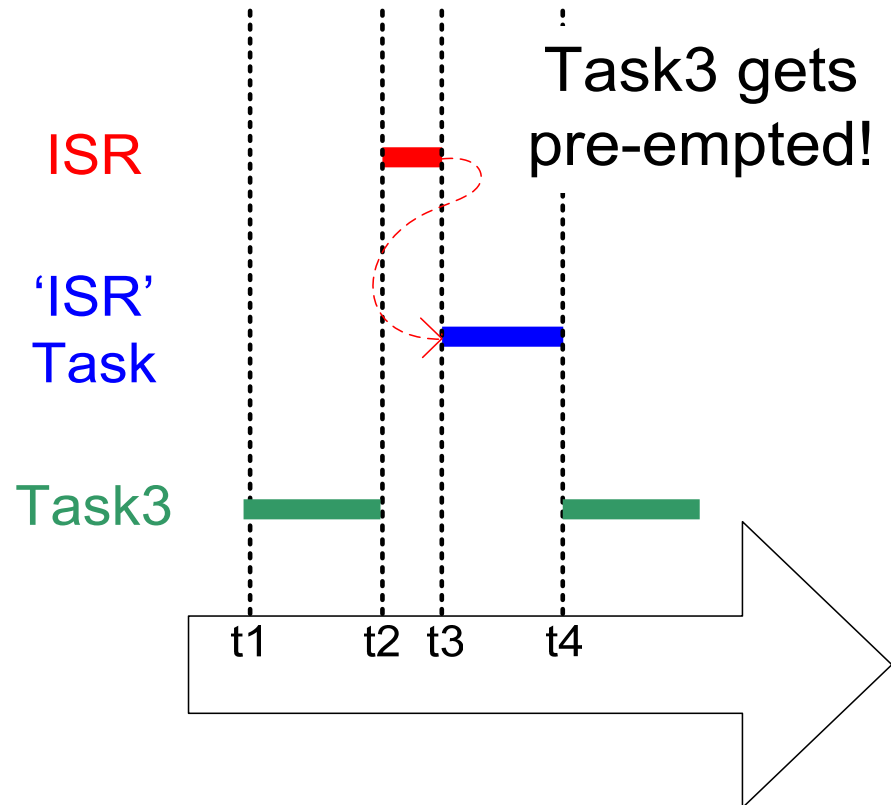



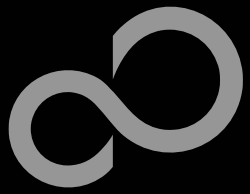

# FreeRTOS™ - Binary Semaphores

- The ISR only 'gives' the semaphore
- The task only 'takes' the semaphore

```
void vAnISR( void )
{
    xSemaphoreGiveFromISR( xSemaphore );
}

/*****

void vTask2( void * pvParameters )
{
    for( ;; )
    {
        xSemaphoreTake( xSemaphore, portMAX_DELAY );
        /* Processing done here. */
    }
}
```

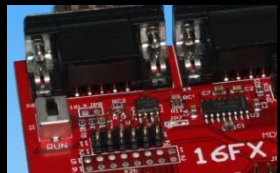

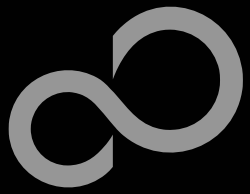

# FreeRTOS™



## ■ FreeRTOS™ - Operating System

- mini Real Time Kernel
- open source
- royalty free (also in commercial applications)
- Free support by an active user community
- <http://www.freertos.org/>

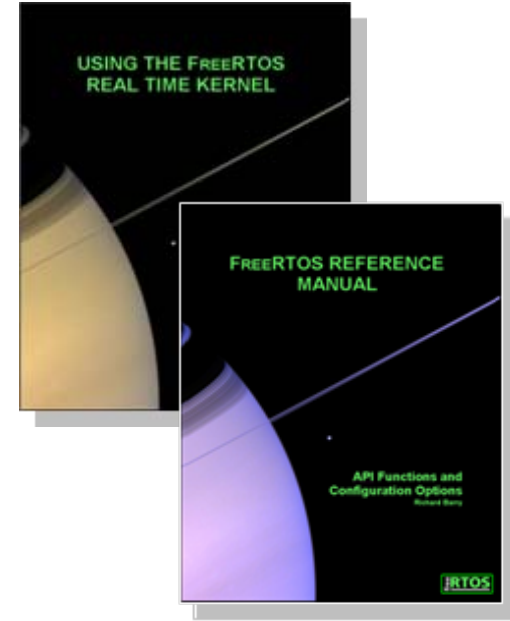

## ■ FreeRTOS™ incl. one example is provided by this starterkit

- [sk16fx48pmc free rtos dice-v10](#)
  - Two 7-segment displays are simulating two virtual dices



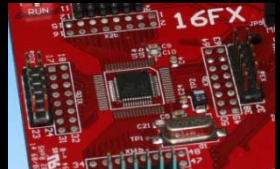
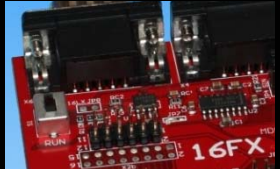
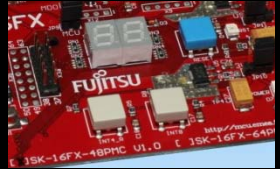
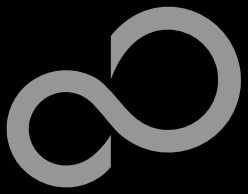

  
**FUJITSU**

THE POSSIBILITIES ARE INFINITE

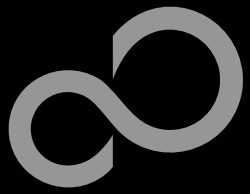

# Further Steps

## ■ In order to learn more about Fujitsu's microcontrollers

- Visit our microcontroller website
  - <http://mcu.emea.fujitsu.com>
    - [http://mcu.emea.fujitsu.com/mcu\\_product/detail/MB96F315RSAPMC.htm](http://mcu.emea.fujitsu.com/mcu_product/detail/MB96F315RSAPMC.htm)
- See our application notes
  - [http://mcu.emea.fujitsu.com/mcu\\_product/mcu\\_all\\_appnotes.htm](http://mcu.emea.fujitsu.com/mcu_product/mcu_all_appnotes.htm)
- See our software examples
  - [http://mcu.emea.fujitsu.com/mcu\\_product/mcu\\_all\\_software.htm](http://mcu.emea.fujitsu.com/mcu_product/mcu_all_software.htm)

## ■ Contact your local distributor ...

- for individual support
- to register for our monthly 16FX seminar
- to order the latest 'Fujitsu Micros DVD' containing all information regarding Fujitsu's 8-bit, 16-bit, and 32-bit microcontrollers

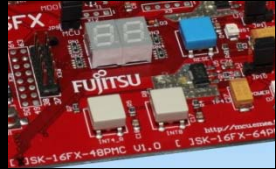

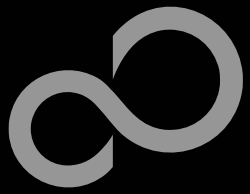

# Optional Tools

## ■ High-end evaluation board

- SK-96310-48PMC (Supports LQFP package M26)

## ■ Hardware emulator

- MB2198-01 + MB2198-500
- Emulation chip MB96V300B
- Probe header MB2198-509 for LQFP package M26
  - Socket NQPACK048SD, HQPACK048SD

## ■ Programmer

- Conitec GALEP-4

## ■ Operating systems

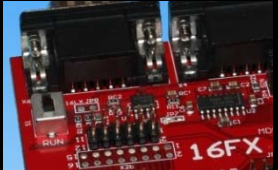
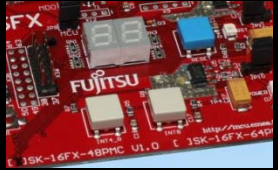

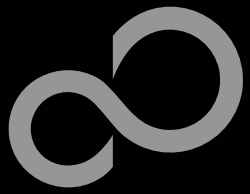

# Evaluation Board

## ■ SK-96310-48PMC V1.0

- Evaluation board for MB96310 Series (for LQFP package M05/M26)
- Emulator target board
- Access to all on-chip peripherals
- 2x UART
- 1x CAN
- 2x LIN
- 8x 'User'-LEDs
- 5x 'User'-Buttons
- Flash-Kit connector
- Connector for LC-Display
- Example projects

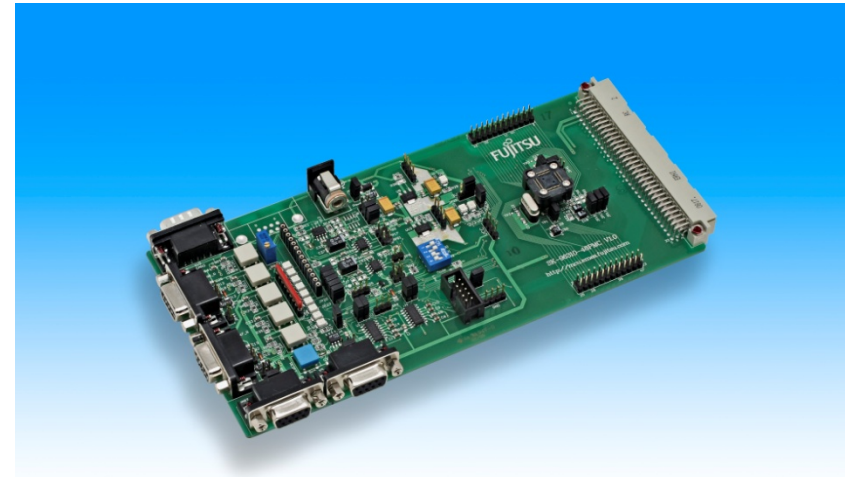

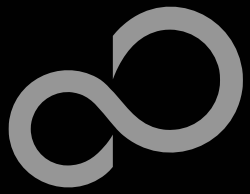

# Hardware Emulator

## ■ In-Circuit emulator for F2MC-16FX

- Main unit (MB2198-01), Adapter (MB2198-500), V-Chip (MB96V300B)
- USB, LAN, and RS232 communication interface
- Connected to target system via Fujitsu probe cable
- High speed operating frequency
- 2052 code / 4 data event breakpoints
- Sequential breakpoints (4 conditions / 3 levels)
- Trace function

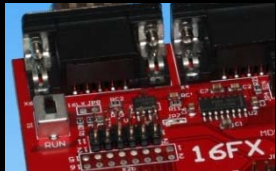
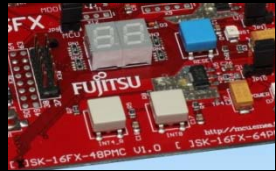



# Hardware Emulator

## ■ Emulation chip MB96V300B

- Superset supports all features of 16FX

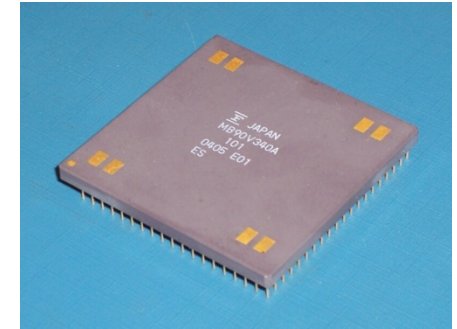

## ■ Probe header

- MB2198-509 for LQFP package M26

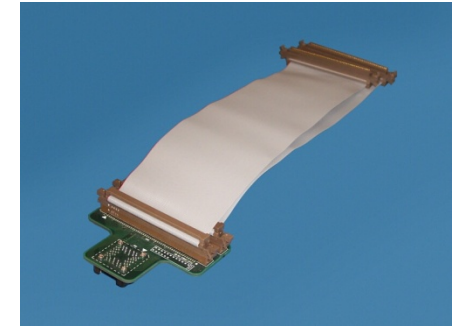

## ■ Socket for LQFP package M26

- NQPACK048SD, HQPACK048SD

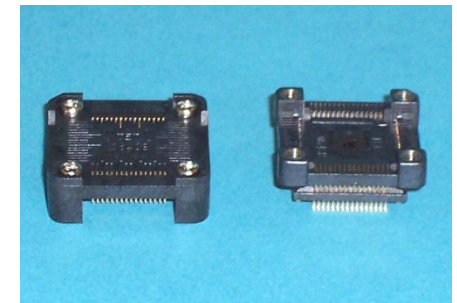



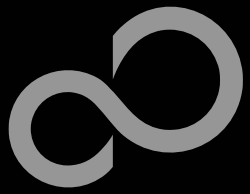

# Programmer

## ■ GALEP-4 / GALEP-5

- Supports parallel programming
- Supports serial synchronous and asynchronous programming
- Optional programming cable for serial synchronous programming
- Allows programming in volume production
- [www.conitec.com](http://www.conitec.com)



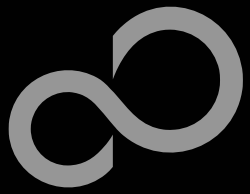

# Operating Systems

## ■ ProOSEK®

- Real-time operating system, OSEK/VDX
- [www.elektrobit.com](http://www.elektrobit.com)

## ■ EUROS

- RTOS including TCP/IP, IrDA, IDE, CAN-Bus, CANopen, Profibus, etc.
- [www.euros-embedded.com](http://www.euros-embedded.com)

## ■ RTA-OSEK

- Realogy Real-Time Architect (RTA) ,OSEK, incl. timing analysis tool
- [www.etasgroup.com](http://www.etasgroup.com)

## ■ embOS

- Small memory footprint for single-chip applications incl. PC viewer
- [www.segger.com](http://www.segger.com)

## ■ osCAN (OSEK/VDX)

- osCAN (OSEK/VDX) and further networking software CAN, LIN, FlexRay, etc.
- [www.vector-informatik.de](http://www.vector-informatik.de)

## ■ FreeRTOS

- Free and open source mini Real Time Scheduler
- [www.FreeRTOS.org](http://www.FreeRTOS.org)

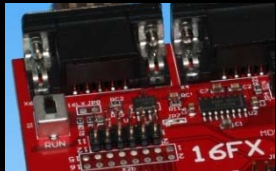
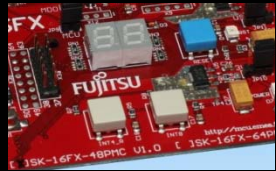

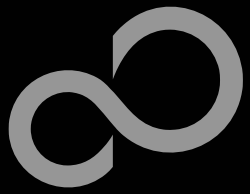

# Contacts - Distribution

## ■ European distributors

■ **ATeG - Anatec AG**

[www.anatec.ch](http://www.anatec.ch)

■ **ATeG - Anatron S.A.**

[www.anatron.com](http://www.anatron.com)

■ **ATeG - Ineltek GmbH**

[www.ineltek.com](http://www.ineltek.com)

■ **EBV Elektronik GmbH**

[www.ebv.com](http://www.ebv.com)

■ **Glyn GmbH & Co. KG**

[www.glyn.de](http://www.glyn.de) , [www.glyn.ch](http://www.glyn.ch)

■ **Malpassi srl**

[www.malpassi.it](http://www.malpassi.it)

■ **Melchioni Electronica SpA**

[www.melchioni.it](http://www.melchioni.it)

■ **PN Electronics**

[www.pne.fr](http://www.pne.fr)

■ **Rutronik**

[www.rutronik.com](http://www.rutronik.com)

■ **Sagitrón**

[www.sagitron.es/english.htm](http://www.sagitron.es/english.htm)

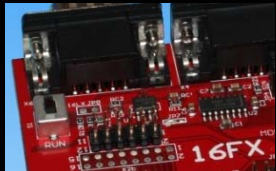
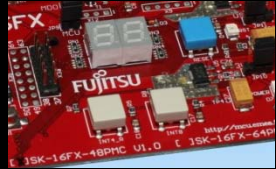

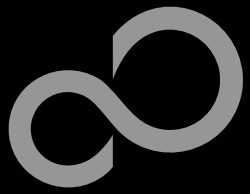

# Fujitsu Semiconductor Europe

## ■ Germany (Headquarters)

- Pittlerstrasse 47, D-63225 Langen
- Tel: (0 61 03) 69 00, Fax: (0 61 03) 69 01 22

## ■ France

- 2-12 Chemin des Femmes, F-91300 Massy
- Tel: (01) 64 47 97 07, Fax: (01) 64 47 97 01

## ■ Italy

- Palazzo Pitagora – Milano 3 City, Via Ludovico il Moro 4B, I-20080 Basiglio, Milano
- Tel: (02) 90 45 02 1, Fax: (02) 90 75 00 87

## ■ United Kingdom

- Network House, Norreys Drive, Maidenhead, Berkshire SL6 4FJ
- Tel: (01628) 50 46 00, Fax: (01628) 50 46 66

## ■ World Wide Web

- <http://emea.fujitsu.com/semiconductor>
- <http://mcu.emea.fujitsu.com>
- Contact: [mcu\\_ticket.FSEU@de.fujitsu.com](mailto:mcu_ticket.FSEU@de.fujitsu.com)



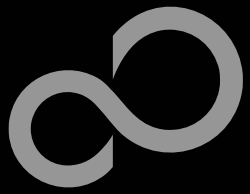

# EU-Konformitätserklärung / EU declaration of conformity

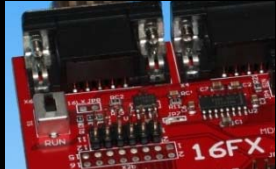
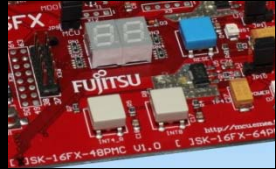

Hiermit erklären wir, Fujitsu Semiconductor Europe GmbH, Pittlerstrasse 47, 63225 Langen, Germany dass dieses Board aufgrund seiner Konzipierung und Bauart sowie in den von uns in Verkehr gebrachten Ausführung(en) den grundlegenden Anforderungen der EU-Richtlinie 2004/108/EC „Elektromagnetische Verträglichkeit“ entspricht. Durch eine Veränderung des Boards (Hard- und/ oder Software) verliert diese Erklärung ihre Gültigkeit!

We, Fujitsu Semiconductor Europe GmbH, Pittlerstrasse 47, 63225 Langen, Germany hereby declare that the design, construction and description circulated by us of this board complies with the appropriate basic safety and health requirements according to the EU Guideline 2004/108/EC entitled 'Electro-Magnetic Compatibility'. Any changes to the equipment (hardware and/ or software) will render this declaration invalid!

## Note:

All data and power supply lines connected to this starter kit should be kept as short as possible, with a maximum allowable length of 3m. Shielded cables should be used for data lines. As a rule of thumb, the cable length used when connecting external circuitry to the MCU pin header connectors for example should be less than 20cm. Longer cables may affect EMC performance and cause radio interference.

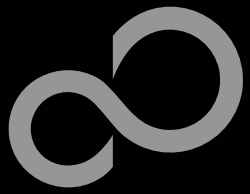

# Recycling

## ■ Gültig für EU-Länder:

- Gemäß der Europäischen WEEE-Richtlinie und deren Umsetzung in landesspezifische Gesetze nehmen wir dieses Gerät wieder zurück.
- Zur Entsorgung schicken Sie das Gerät bitte an die folgende Adresse:

## ■ Valid for European Union Countries:

- According to the European WEEE-Directive and its implementation into national laws we take this device back.
- For disposal please send the device to the following address:

**Fujitsu Semiconductor Europe GmbH**

**Warehouse/Disposal**

**Monzastraße 4a**

**D-63225 Langen**

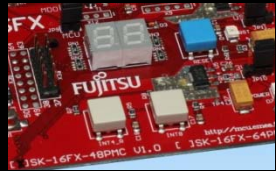

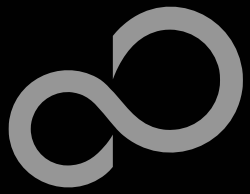

# Fujitsu Semiconductor Europe

## ■ 'SK-16FX-48PMC'-CD Link-List

- Software
  - [Softtune Workbench](#)
  - [EUROScope lite 16FX](#)
  - [MCU Flash programmer](#)
  - [SKwizard](#)
- Software Examples
  - [sk16fx48pmc adc dvm](#)
  - [sk16fx48pmc can uart terminal](#)
  - [sk16fx48pmc counter](#)
  - [sk16fx48pmc template](#)
  - [sk16fx48pmc uart](#)
  - [sk16fx48pmc free rtos dice](#)
  - [sk16fx48pmc uart 7seg](#)
- Documents
  - [Schematic 'SK-16FX-48PMC'](#)
  - [Data sheet MB96310 Series](#)
  - [Hardware manual 16FX Family](#)
  - [AppNote '16FX Hardware Setup'](#)
  - [AppNote '16FX Getting Started'](#)
  - [Customer Information 16FX](#)
  - [EUROScope Reference Manual](#)
  - [AppNote ,EUROScope'](#)
  - [Customer Information of ,EUROScope' limitations](#)

