

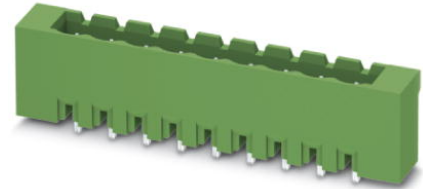

**MSTBVA 2,5/15-G-5,08-LR**

Order No.: 1809393

<http://eshop.phoenixcontact.co.uk/phoenix/treeViewClick.do?UID=1809393>

Header, Nominal current: 12 A, Rated voltage (III/2): 320 V, Number of positions: 15, Pitch: 5.08 mm, Color: green, Contact surface: Tin, Assembly: Soldering

**Commercial data**

EAN	 4 046356 703642
Note	Made-to-order
Pack	50
Customs tariff	85366990
Gross weight in pieces	7.23 g
Country of Origin	DE

**Product notes**

WEEE/RoHS-compliant since:  
23/09/2011



Please note that the data given here has been taken from the online catalog. For comprehensive information and data, please refer to the user documentation at <http://www.download.phoenixcontact.com>. The General Terms and Conditions of Use apply to Internet downloads.

**Technical data****Dimensions / positions**

Length	8.6 mm
Height	14.6 mm
Pitch	5.08 mm
Dimension a	71.12 mm
Number of positions	15

Pin dimensions	1 x 1 mm
Hole diameter	1.4 mm

#### Technical data

Range of articles	MSTBVA 2,5/..-G-LR
Insulating material group	IIIa
Rated surge voltage (III/3)	4 kV
Rated surge voltage (III/2)	4 kV
Rated surge voltage (II/2)	4 kV
Rated voltage (III/2)	320 V
Rated voltage (II/2)	400 V
Connection in acc. with standard	EN-VDE
Nominal current $I_N$	12 A
Nominal voltage $U_N$	250 V
Maximum load current	12 A
Insulating material	PBT
Inflammability class according to UL 94	V0
Color	green
Nominal voltage, UL/CUL Use Group B	300 V
Nominal current, UL/CUL Use Group B	15 A
Nominal voltage, UL/CUL Use Group D	300 V
Nominal current, UL/CUL Use Group D	15 A

#### Certificates

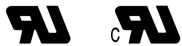

Certification

cULus Recognized

Certifications applied for:

Certification Ex:

**Accessories**

Item	Designation	Description
<b>Assembly</b>		
1755477	MSTB-BL	Keying cap, for forming sections, plugs onto header pin, green insulating material
<b>Marking</b>		
0804293	SK 5,08/3,8:FORTL.ZAHLEN	Marker cards, Card, white, labeled, Horizontal: Consecutive numbers 1 - 10, 11 - 20, etc. up to 91 - (99)100, Mounting type: Adhesive, For terminal block width: 5.08 mm
<b>Plug/Adapter</b>		
1734401	CR-MSTB	Coding section, inserted into the recess in the header or the inverted plug, red insulating material

**Drawings**

Drilling plan/solder pad geometry

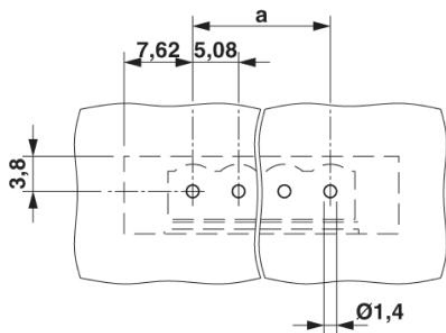

Dimensioned drawing

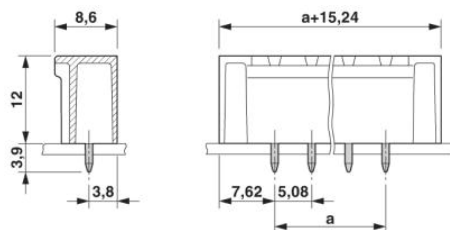

**Address**

PHOENIX CONTACT Ltd  
Halesfield 13  
Telford / Shropshire / TF7 4PG,England  
Phone 01952 681 700  
Fax 01952 681 799  
<http://www.phoenixcontact.co.uk>



Phoenix Contact Ltd.  
Technical modifications reserved;