

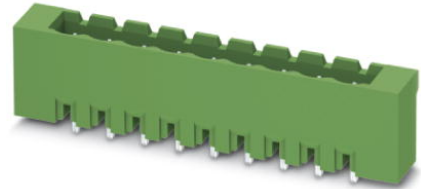

MSTBVA 2,5/19-G-5,08-LR

Order No.: 1809432

<http://eshop.phoenixcontact.co.uk/phoenix/treeViewClick.do?UID=1809432>

Header, Nominal current: 12 A, Rated voltage (III/2): 320 V, Number of positions: 19, Pitch: 5.08 mm, Color: green, Contact surface: Tin, Assembly: Soldering

Commercial data	
EAN	 4 046356 703680
Note	Made-to-order
Pack	50
Customs tariff	85366990
Gross weight in pieces	8.90 g
Country of Origin	DE

Product notes

WEEE/RoHS-compliant since:
23/09/2011



Please note that the data given here has been taken from the online catalog. For comprehensive information and data, please refer to the user documentation at <http://www.download.phoenixcontact.com>. The General Terms and Conditions of Use apply to Internet downloads.

Certificates



Certification

cULus Recognized

Certifications applied for:

Certification Ex:

Accessories

Item	Designation	Description
Assembly		
1755477	MSTB-BL	Keying cap, for forming sections, plugs onto header pin, green insulating material

Marking		
0804293	SK 5,08/3,8:FORTL.ZAHLEN	Marker cards, Card, white, labeled, Horizontal: Consecutive numbers 1 - 10, 11 - 20, etc. up to 91 - (99)100, Mounting type: Adhesive, For terminal block width: 5.08 mm

Plug/Adapter		
1734401	CR-MSTB	Coding section, inserted into the recess in the header or the inverted plug, red insulating material

Drawings

Drilling plan/solder pad geometry

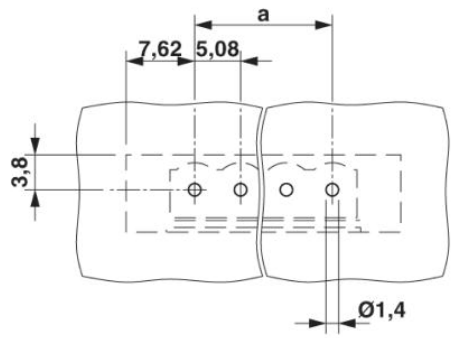

Dimensioned drawing

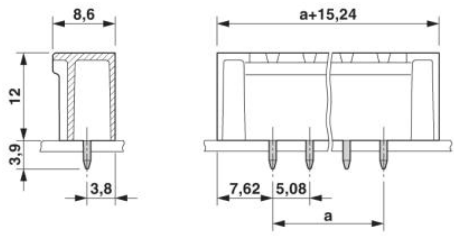

Address

PHOENIX CONTACT Ltd
Halesfield 13
Telford / Shropshire / TF7 4PG,England
Phone 01952 681 700
Fax 01952 681 799
<http://www.phoenixcontact.co.uk>



Phoenix Contact Ltd.
Technical modifications reserved;