

Features

Range of electronic staircase timers

- 17.5 mm wide
- Time setting from 30 seconds to 20 minutes
- "Zero crossing" load switching
- "Switch-off early warning" - model 14.01
- Suitable for 3 or 4 wire systems, with automatic recognition (14.01 and 14.71) or via "pushbutton configuration" (14.81)
- LED status indicators (14.01 and 14.71)
- Cadmium free contact material
- Can be used with illuminated push - buttons
- "Blade + cross" - both flat blade and cross head screw drivers can be used to adjust the function selector, the timing trimmer, and to disengage the 35 mm rail mounting clip
- European Patent

14.01



- Multi-function
- 1 NO (SPST-NO)
- 35 mm rail (EN 60715) mount

14.71



- Mono-function
- 1 NO (SPST-NO)
- 35 mm rail (EN 60715) mount

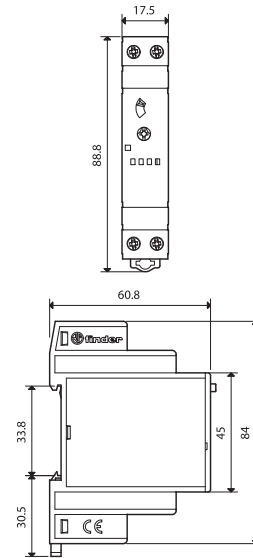
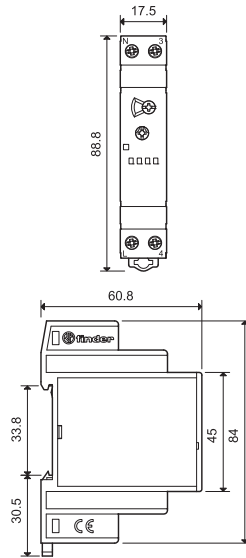

Contact specification			
Contact configuration		1 NO (SPST-NO)	1 NO (SPST-NO)
Rated current/Maximum peak current	A	16/30 (120 A - 5 ms)	16/30 (120 A - 5 ms)
Rated voltage/Maximum switching voltage V AC		230/—	230/—
Rated load AC1	VA	3,700	3,700
Rated load AC15 (230 V AC)	VA	750	750
Nominal lamp rating:incandescent (230 V)	W	3,000	3,000
compensated fluorescent (230 V)	W	1,000	1,000
uncompensated fluorescent (230 V)	W	1,000	1,000
halogen (230 V)	W	3,000	3,000
Minimum switching load	mW (V/mA)	1,000 (10/10)	1,000 (10/10)
Standard contact material		AgSnO ₂	AgSnO ₂
Supply specification			
Nominal voltage (U _N)	V AC (50/60 Hz)	230	230
	V DC	—	—
Rated power	VA (50 Hz)/W	3/1.2	3/1.2
Operating range	AC (50 Hz)	(0.8...1.1)U _N	(0.8...1.1)U _N
	DC	—	—
Technical data			
Electrical life at rated load in AC1	cycles	100 · 10 ³	100 · 10 ³
Delay setting	min	0.5...20	0.5...20
Max no. of illuminated push-button (≤ 1 mA)		30	30
Maximum impulse duration		continuous	continuous
Ambient temperature range	°C	-10...+60	-10...+60
Protection category		IP 20	IP 20
Approvals (according to type)			

Features

Range of electronic staircase timers

- 17.5 mm wide
- Time setting from 30 seconds to 20 minutes
- "Zero crossing" load switching
- Types 14.81 and 14.91: wiring compatible with mechanical versions and with old type (low emission) illuminated pushbuttons
- Suitable for 3 or 4 wire systems, with automatic recognition (14.01 and 14.71) or via "pushbutton configuration" (14.81)
- Cadmium free contact material
- Can be used with illuminated push - buttons
- "Blade + cross" - both flat blade and cross head screw drivers can be used to adjust the function selector, the timing trimmer, and to disengage the 35 mm rail mounting clip

14.81



- Mono-function
- 1 NO (SPST-NO)
- 35 mm rail (EN 60715) mount
- All terminals on same side

14.91



- Mono-function
- 1 NO (SPST-NO)
- 35 mm rail (EN 60715) mount
- 3 terminals, on same side

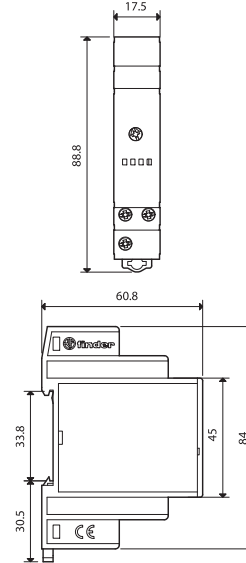
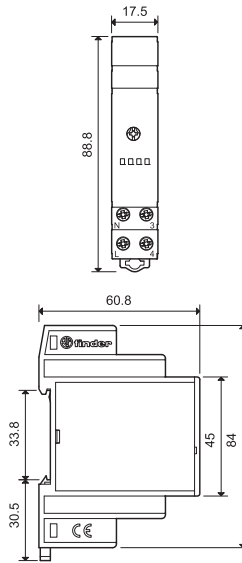

Contact specification		14.81	14.91
Contact configuration		1 NO (SPST-NO)	1 NO (SPST-NO)
Rated current/Maximum peak current	A	16/30 (120 A - 5 ms)	16/30 (120 A - 5 ms)
Rated voltage/Maximum switching voltage V AC		230/—	230/—
Rated load AC1	VA	3,700	3,700
Rated load AC15 (230 V AC)	VA	750	750
Nominal lamp rating:incandescent (230 V)	W	3,000	3,000
compensated fluorescent (230 V)	W	1,000	1,000
uncompensated fluorescent (230 V)	W	1,000	1,000
halogen (230 V)	W	3,000	3,000
Minimum switching load	mW (V/mA)	1,000 (10/10)	1,000 (10/10)
Standard contact material		AgSnO ₂	AgSnO ₂
Supply specification		14.81	14.91
Nominal voltage (U _N)	V AC (50/60 Hz)	230	230
	V DC	—	—
Rated power	VA (50 Hz)/W	3/1.2	3/1.2
Operating range	AC (50 Hz)	(0.8...1.1)U _N	(0.8...1.1)U _N
	DC	—	—
Technical data		14.81	14.91
Electrical life at rated load in AC1	cycles	100 · 10 ³	100 · 10 ³
Delay setting	min	0.5...20	0.5...20
Max no. of illuminated push-button (≤ 1 mA)		25	25
Maximum impulse duration		continuous	continuous
Ambient temperature range	°C	-10...+60	-10...+60
Protection category		IP 20	IP 20
Approvals (according to type)		CE PG Y Nf	CE PG

Ordering information

Example: 14 series multi-function relay, single phase switch 1 NO (SPDT-NO) 16 A contact, supply rated at 230 V AC.

1 4 . 0 1 . 8 . 2 3 0 . 0 0 0 0

Series

Type

- 0 = 35 mm rail (EN 60715) mount, multi-function
- 7 = 35 mm rail (EN 60715) mount, mono-function
- 8 = 35 mm rail (EN 60715) mount mono-function, all terminals on same side
- 9 = 35 mm rail (EN 60715) mount, mono-function, 3 terminals

No. of poles

- 1 = Single phase switch, 16 A

Supply voltage

230 = 230 V

Supply version

8 = AC (50/60 Hz)

Technical data

Insulation			
Dielectric strength between open contacts	V AC	1,000	
Other data			
Power lost to the environment			
	without contact current	W	1.2
	with rated current	W	2
Maximum cable length for push-button connection	m	200	
Screw torque	Nm	0.8	
Max. wire size		solid cable	stranded cable
	mm ²	1x6 / 2x4	1x4 / 2x2.5
	AWG	1x10 / 2x12	1x12 / 2x14

Zero crossing switching

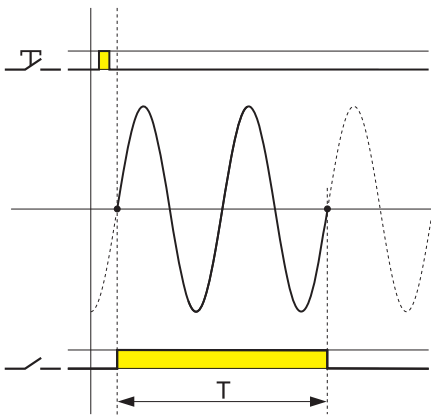

1. Lower inrush current protects and increases lamp life
2. Lower inrush current reduces the possibility of contact welding
3. The current at switch-off is also lower, reducing stress and wear on the contacts

Note

Using the type 14.91, the lamps are switched on directly by the pushbutton

Accessories



020.01

Adaptor for panel mounting, 17.5 mm wide

020.01



060.72

Sheet of marker tags, plastic, 72 tags, 6x12 mm

060.72

Wiring diagrams

Type 14.01

14.71

Red LED indication:
 Continuous = relay ON
 Blinking = relay OFF

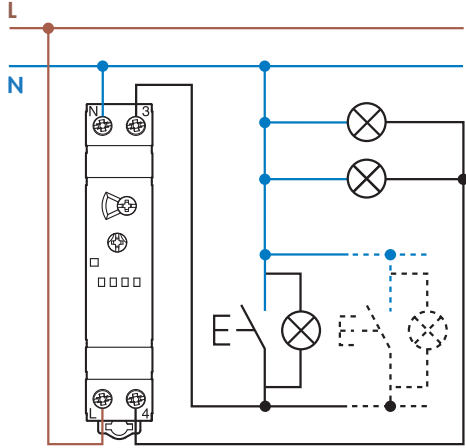

3 wire connection

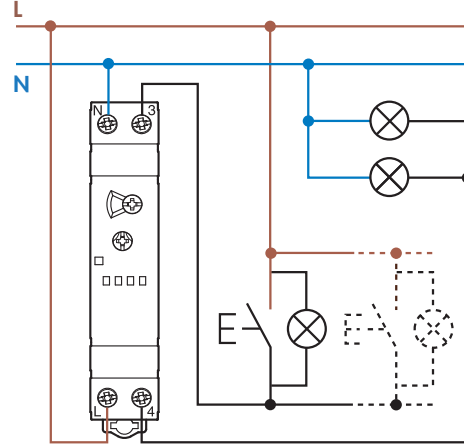

4 wire connection

Type 14.81 (pushbutton configuration procedure, as per the Installation manual)

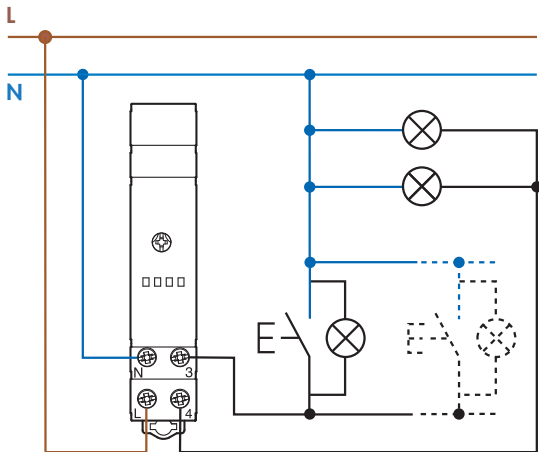

3 wire connection

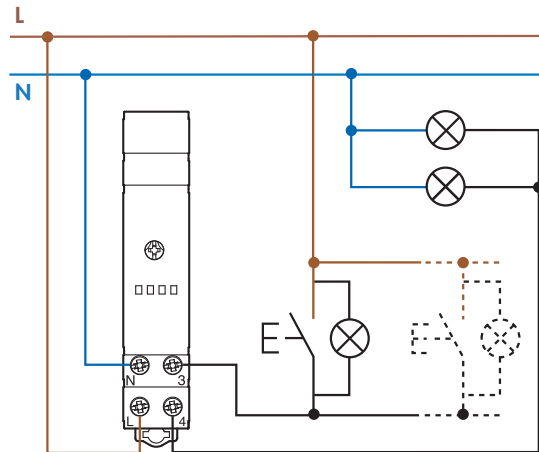

4 wire connection

Type 14.91 (the push-buttons must be rated for the load current)

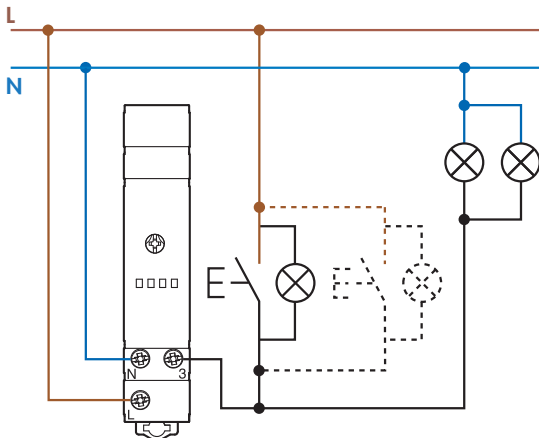

Wiring diagrams - 14.01 triggered by PIR movement detector (18 series)

3 wire connection (with 18.21.8.230.0300 or 18.31.8.230.0300 only)

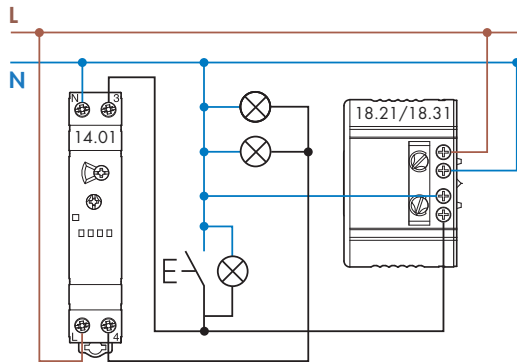

4 wire connection (with 18.01.8.230.0000, 18.11.8.230.0000, 18.21.8.230.0300 or 18.31.8.230.0300)

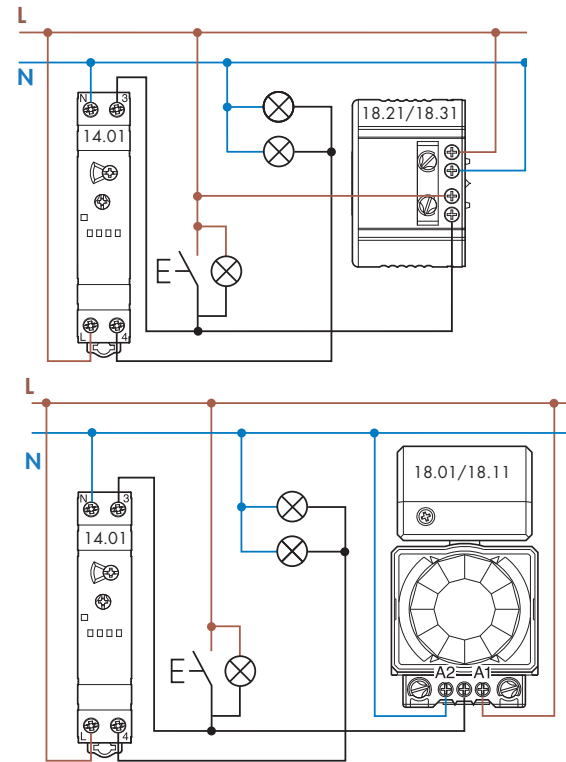

Functions

Type 14.01 Functions selectable with front rotary selector

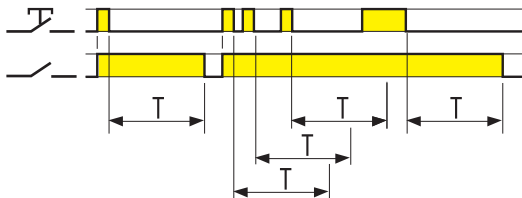

(BE) Staircase relay

On initial impulse the output contact closes and timing starts for the pre-set duration; subsequent impulses during the timing period will extend the timing period by the full pre-set value. On expiry of the time delay, the output contact opens.

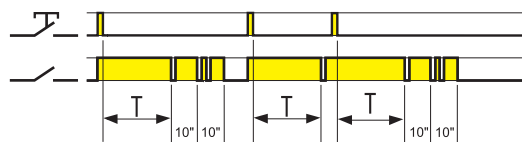

(BP) Staircase relay with early warning

On initial impulse the output contact closes and the timing starts for the pre-set duration. After the timing period, the output contact blinks off once; 10secs later the contact blinks off twice, and after a further 10secs the contact opens. During the pre-set and 20 second warning time, it is possible, by a further impulse, to extend the time by the full pre-set value.

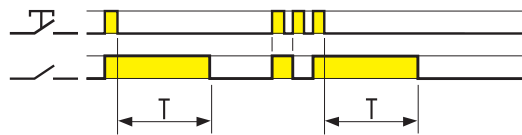

(IT) Timing step relay

On initial impulse the output contact closes and timing starts for the pre-set duration; On expiry of the time delay, the output contact opens. During the timing period it is possible to immediately open the contact with a further impulse.

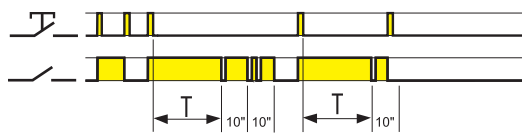

(IP) Timing step relay with early warning

On initial impulse the output contact closes and timing starts for the pre-set duration; After the timing period, the output contact blinks off once; 10 secs later the contact blinks off twice, and after a further 10 secs the contact opens. During the pre-set and 20 second warning time, it is possible to immediately open the output contact by a further impulse.

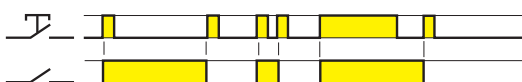

(RI) Step relay

After every impulse, the output contact changes state - alternately switching from open to closed and vice versa.

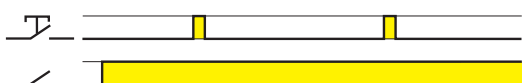

Light ON

With this function set - the output contact stays permanently closed.

NOTE: The blinking within the Early Warning functions (BP and IP) could cause re-start problems for fluorescent lamps with electromagnetic chokes (both conventional and compact types); We consequently suggest not to use such lamps with these functions.

Functions

Type 14.71 Functions selectable with front selector

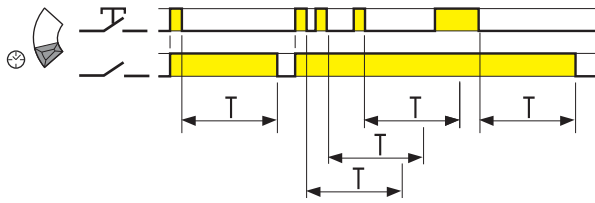

Staircase relay

On initial impulse the output contact closes and timing starts for the pre-set duration; subsequent impulses during the timing period will extend the timing period by the full pre-set value. On expiry of the time delay, the output contact opens.

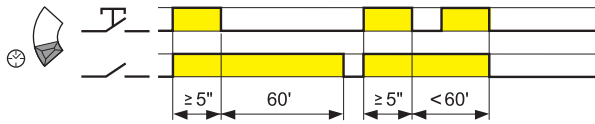

"Staircase maintenance" function

An impulse of ≥ 5 seconds will close the output contact for 60 minutes, after which time the contact will open. Ideal for maintenance or cleaning activities. The 60' timing can be interrupted by a further impulse of ≥ 5 seconds, the output contact opens.



Light ON

With this function set - the output contact stays permanently closed.

Type 14.81

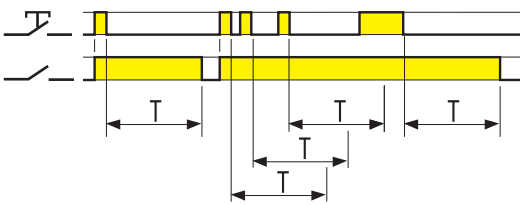

Staircase relay

On initial impulse the output contact closes and timing starts for the pre-set duration; subsequent impulses during the timing period will extend the timing period by the full pre-set value. On expiry of the time delay, the output contact opens.

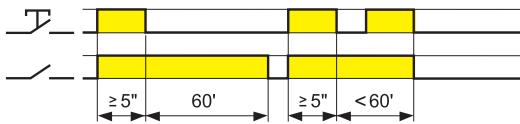

"Staircase maintenance" function

An impulse of ≥ 5 seconds will close the output contact for 60 minutes, after which time the contact will open. Ideal for maintenance or cleaning activities. The 60' timing can be interrupted by a further impulse of ≥ 5 seconds, which will re-establish the staircase timer function; so on expiry of the staircase time delay, the output contact opens.

Type 14.91

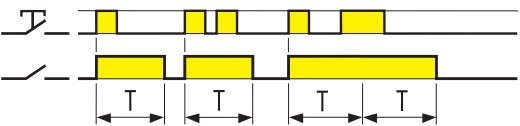

Signal ON pulse

On initial impulse the output contact closes, and remain so for the duration of the preset delay. On expiry of the time delay, the output contact opens.