

NPN Silicon Epitaxial Planar Transistor

MMST3904

FEATURES

- Power dissipation.($P_C=0.2W$)



Lead-free

APPLICATIONS

- Audio frequency general purpose amplifier.

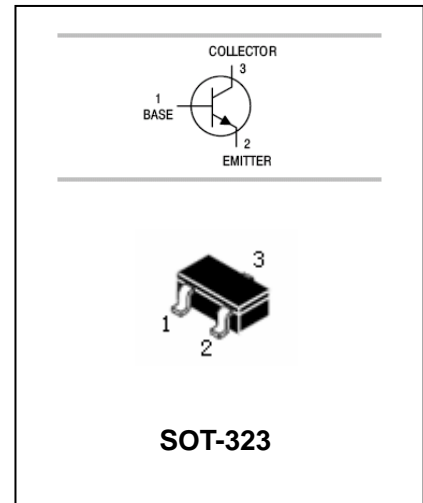

ORDERING INFORMATION

Type No.	Marking	Package Code
MMST3904	K2N	SOT-323

MAXIMUM RATING @ $T_a=25^{\circ}C$ unless otherwise specified

Symbol	Parameter	Value	Units
V_{CBO}	Collector-Base Voltage	60	V
V_{CEO}	Collector-Emitter Voltage	40	V
V_{EBO}	Emitter-Base Voltage	5	V
I_C	Collector Current -Continuous	200	mA
P_C	Collector Dissipation	200	mW
T_j, T_{stg}	Junction and Storage Temperature	-55~150	$^{\circ}C$

NPN Silicon Epitaxial Planar Transistor

MMST3904

ELECTRICAL CHARACTERISTICS @ Ta=25°C unless otherwise specified

Parameter	Symbol	Test conditions	MIN	MAX	UNIT
Collector-base breakdown voltage	$V_{(BR)CBO}$	$I_C=10\mu A, I_E=0$	60		V
Collector-emitter breakdown voltage	$V_{(BR)CEO}$	$I_C=1mA, I_B=0$	40		V
Emitter-base breakdown voltage	$V_{(BR)EBO}$	$I_E=10\mu A, I_C=0$	5		V
Collector cut-off current	I_{CBO}	$V_{CB}=60V, I_E=0$		0.05	μA
Collector cut-off current	I_{CEO}	$V_{CE}=40V, I_B=0$		0.5	μA
Emitter cut-off current	I_{EBO}	$V_{EB}=5V, I_C=0$		0.05	μA
DC current gain	h_{FE}	$V_{CE}=1V, I_C=0.1mA$	40	300	
		$V_{CE}=1V, I_C=1mA$	70		
		$V_{CE}=1V, I_C=10mA$	100		
		$V_{CE}=1V, I_C=50mA$	60		
		$V_{CE}=1V, I_C=100mA$	30		
Collector-emitter saturation voltage	$V_{CE(sat)}$	$I_C=10mA, I_B=1mA$ $I_C=50mA, I_B=5mA$		0.25 0.3	V
Base-emitter saturation voltage	$V_{BE(sat)}$	$I_C=10mA, I_B=1mA$ $I_C=50mA, I_B=5mA$	0.65	0.85 0.95	V
Transition frequency	f_T	$V_{CE}=20V, I_E=10mA$ $f=100MHz$	300		MHz
Collector output capacitance	C_{ob}	$V_{CB}=5V, I_E=0, f=1MHz$		4	pF
Noise figure	NF	$V_{CE}=5V, I_C=0.1mA,$ $f=1KHz, R_g=1K\Omega$		5	dB
Delay time	t_d	$V_{CC}=3V, V_{BE}=0.5V,$ $I_C=10mA, I_B=1mA$		35	nS
Rise time	t_r			35	nS
Storage time	t_s	$V_{CC}=3V, I_C=10mA,$ $I_{B1}=I_{B2}=1mA$		200	nS
Fall time	t_f			50	nS

TYPICAL CHARACTERISTICS @ Ta=25°C unless otherwise specified

NPN Silicon Epitaxial Planar Transistor

MMST3904

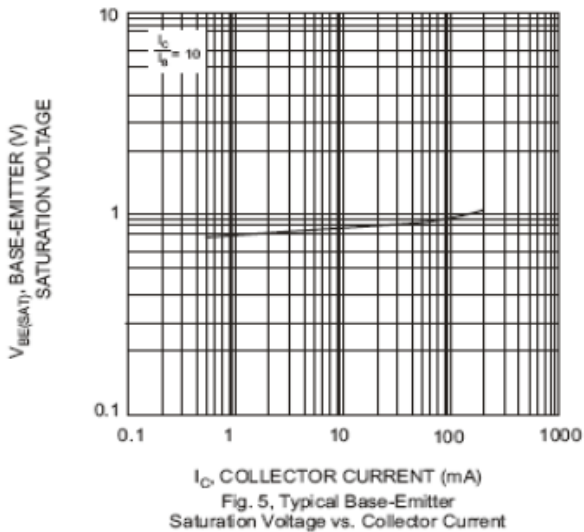
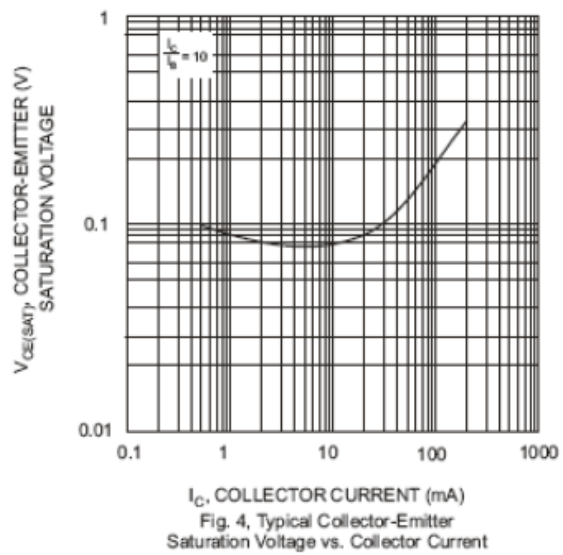
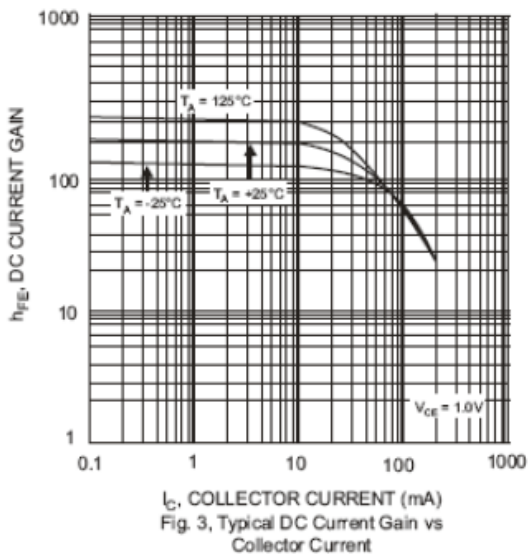
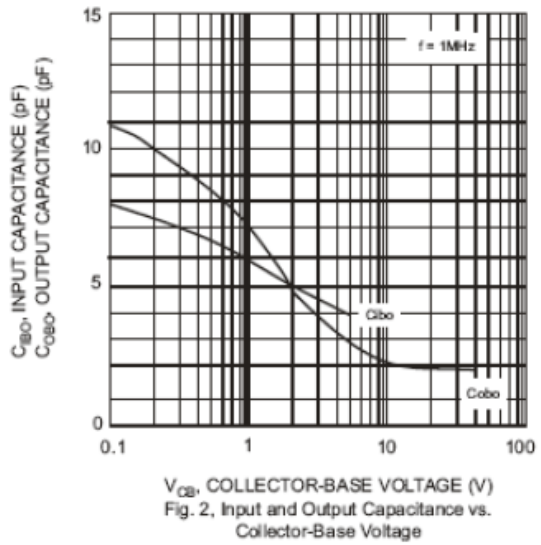
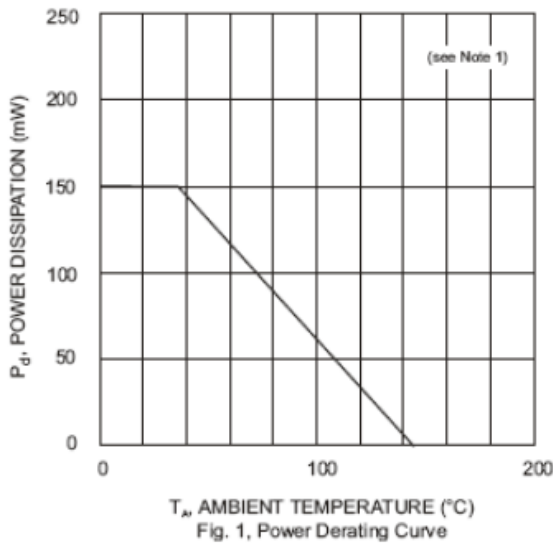

NPN Silicon Epitaxial Planar Transistor

MMST3904

PACKAGE OUTLINE

Plastic surface mounted package

SOT-323

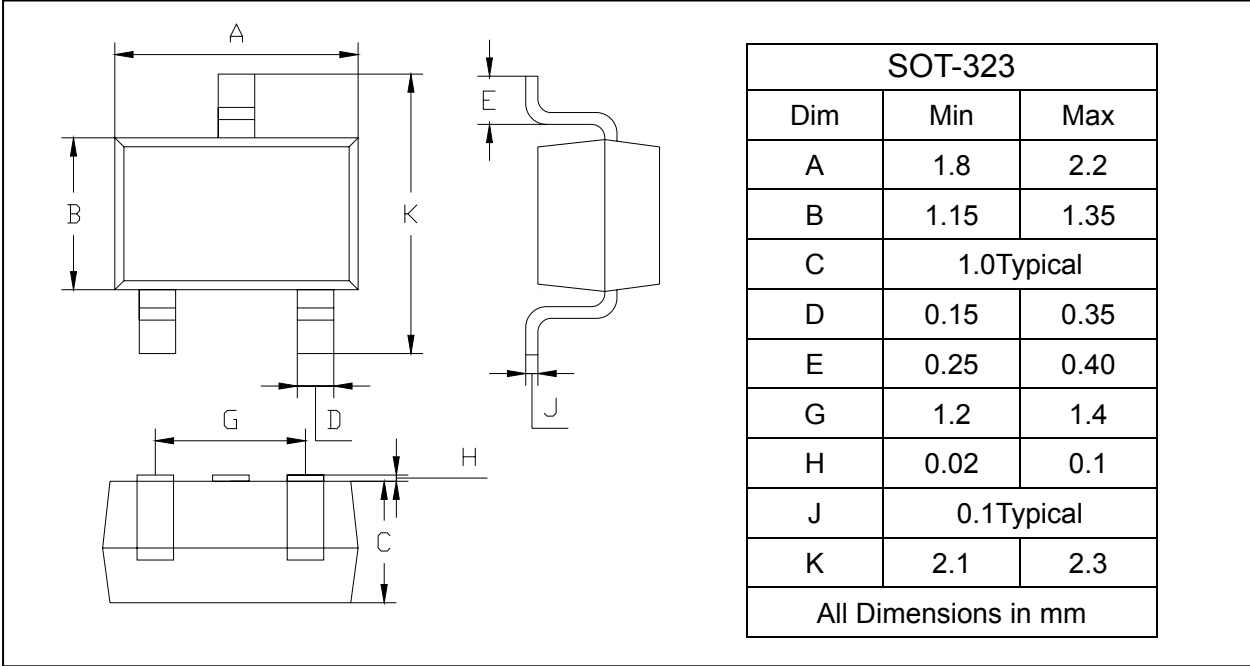

SOLDERING FOOTPRINT

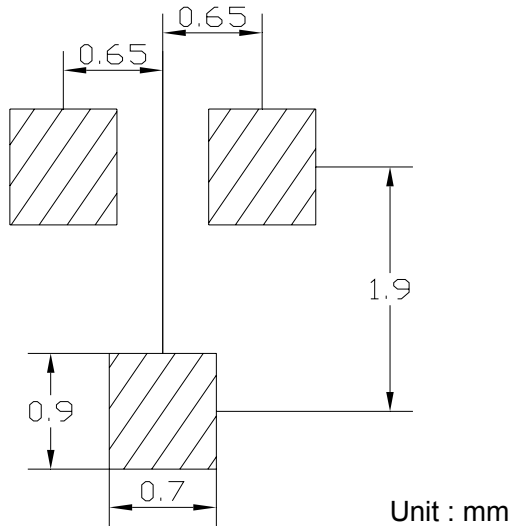

PACKAGE INFORMATION

Device	Package	Shipping
MMST3904	SOT-323	3000/Tape&Reel