

**PLEASE CHECK WWW.MOLEX.COM FOR LATEST PART INFORMATION**

**Part Number:** [55935-0710](#)  
**Status:** **Active**  
**Overview:** [MicroClasp™](#)  
**Description:** 2.00mm Pitch MicroClasp™ Wire-to-Board Header, Single Row, Right Angle, 7 Circuits, with PCB Locator

**Documents:**

[3D Model](#) [Product Specification PS-51382-004 \(PDF\)](#)  
[Drawing \(PDF\)](#) [RoHS Certificate of Compliance \(PDF\)](#)

**General**

Product Family	PCB Headers
Series	<a href="#">55935</a>
Application	Signal, Wire-to-Board
Overview	<a href="#">MicroClasp™</a>
Product Name	MicroClasp™
UPC	800756632155

**Physical**

Breakaway	No
Circuits (Loaded)	7
Circuits (maximum)	7
Color - Resin	Natural
Durability (mating cycles max)	30
First Mate / Last Break	No
Glow-Wire Compliant	No
Guide to Mating Part	No
Keying to Mating Part	None
Lock to Mating Part	Yes
Material - Plating Mating	Tin
Material - Plating Termination	Tin
Material - Resin	Polyester
Net Weight	754.800/mg
Number of Rows	1
Orientation	Right Angle
PC Tail Length	3.20mm
PCB Locator	Yes
PCB Retention	Yes
PCB Thickness - Recommended	1.60mm
Packaging Type	Tray
Pitch - Mating Interface	2.00mm
Shrouded	Fully
Stackable	No
Surface Mount Compatible (SMC)	No
Temperature Range - Operating	-25°C to +85°C
Termination Interface: Style	Through Hole

**Electrical**

Current - Maximum per Contact	3A
Voltage - Maximum	250V

**Material Info**

**Reference - Drawing Numbers**

Product Specification	PS-51382-004, RPS-51382-006, RPS-51382-007, RPS-51382-008, RPS-51382-009, RPS-51382-010,
-----------------------	---

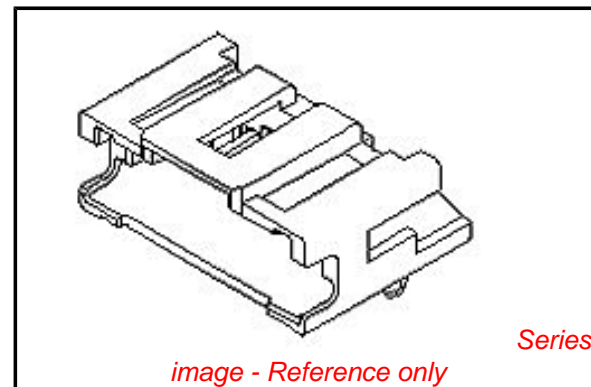

**EU RoHS**

**ELV and RoHS  
Compliant**

**REACH SVHC**

Not Reviewed

**Low-Halogen Status**

**Not Low-Halogen**

**China RoHS**



**Need more information on product  
environmental compliance?**

Email [productcompliance@molex.com](mailto:productcompliance@molex.com)  
 For a multiple part number RoHS Certificate of Compliance, [click here](#)

Please visit the [Contact Us](#) section for any non-product compliance questions.

**Search Parts in this Series**

[55935Series](#)

**Mates With**

51382 MicroClasp™ Wire-to-Board  
 Receptacle Housing

Sales Drawing

RPS-51382-011, RPS-51382-012, RPS-51382-013,  
RPS-51382-014, RPS-51382-015  
SD-55935-005

This document was generated on 01/16/2013

**PLEASE CHECK [WWW.MOLEX.COM](http://WWW.MOLEX.COM) FOR LATEST PART INFORMATION**